

Bovie®

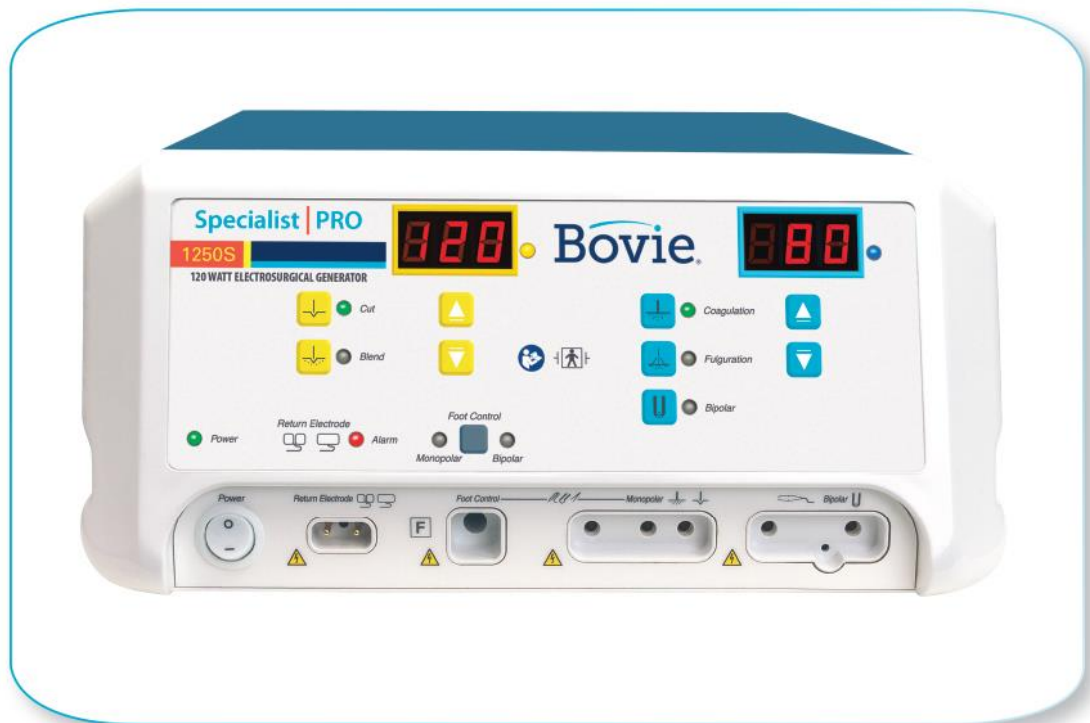

SPECIALIST | PRO

Electrosurgical Generator for Veterinarian Use

User's Guide

Bovie

Intro



USER'S GUIDE

This manual and the equipment it describes are for use only by qualified medical professionals trained in the particular technique and surgical procedure to be performed. It is intended as a guide for using the Specialist|PRO™ only.

Additional technical information is available in the Specialist|PRO Service Guide. For the latest information and technical bulletins, visit www.symmetrysurgical.com.

Equipment Covered in this Manual

User's Guide • Specialist|PRO
Reference No.: A1250S-V

For Information Contact

Symmetry Surgical • 3034 Owen Drive • Antioch, TN 37013
U.S. & CA 1 800 251-3000 •
EMEA & LATAM +1 615-964-5532 • ASIA & AUS/NZ +61 3 9413 555
www.symmetrysurgical.com • customerservice@symmetrysurgical.com

©2022 Symmetry Surgical. All rights reserved. Contents of this publication may not be reproduced without the written permission of Symmetry Surgical, Inc.

The Bovie® trademark is a registered trademark of Symmetry Surgical, Inc., or its affiliates in the United States and other countries around the world. Authentic Bovie products are manufactured and sold exclusively by Symmetry Surgical, Inc.

Symmetry Surgical Part Number MC-55-240-001_3

CONVENTIONS USED IN THIS GUIDE

WARNING:

Indicates a potentially hazardous situation which, if not avoided, could result in death or serious injury.

CAUTION:

Indicates a hazardous situation which, if not avoided, may result in minor or moderate injury.

NOTICE:

Indicates an operating tip, a maintenance suggestion, or a hazard that may result in product damage.

TABLE OF CONTENTS

EQUIPMENT COVERED IN THIS MANUAL.....	3
FOR INFORMATION CONTACT	3
CONVENTIONS USED IN THIS GUIDE.....	3
LIST OF FIGURES.....	6
SECTION 1 - INTRODUCING THE SPECIALIST PRO ELECTROSURGICAL GENERATOR.....	7
INDICATIONS FOR USE.....	8
OPERATING PRINCIPLES.....	8
INTENDED USE.....	8
KEY FEATURES.....	8
COMPONENTS AND ACCESSORIES	9
SAFETY	9
APPLICATION SPECIFICATION	13
SECTION 2 - CONTROLS, INDICATORS, AND RECEPTACLES.....	15
FRONT PANEL	16
SYMBOLS ON THE FRONT PANEL.....	17
CUT AND BLEND CONTROLS	18
COAG AND BIPOLAR CONTROLS.....	19
INDICATORS.....	20
POWER SWITCH AND RECEPTACLES.....	21
REAR PANEL.....	22
SYMBOLS ON THE REAR PANEL	22
SECTION 3 - GETTING STARTED.....	23
INITIAL INSPECTION.....	24
INSTALLATION	24
FUNCTION CHECKS	24
SETTING UP THE UNIT	24
CHECKING THE PATIENT RETURN ELECTRODE ALARM.....	24
CONFIRMING MODES.....	25
Checking Bipolar Mode (with Footswitch).....	25
Checking Monopolar Mode (with Footswitch)	25
Checking Monopolar Mode (with Handswitch)	25
PERFORMANCE CHECKS	25
SECTION 4 - USING THE SPECIALIST PRO ELECTROSURGICAL GENERATOR.....	27
INSPECTING THE GENERATOR AND ACCESSORIES	28
SETUP SAFETY.....	28
SETTING UP.....	30
PREPARING FOR MONOPOLAR SURGERY.....	31
Applying the Return Electrode.....	31

Connecting Accessories	32
PREPARING FOR BIPOLAR SURGERY	32
ACTIVATION SAFETY	32
ACTIVATING THE UNIT	34
SECTION 5 - MAINTAINING THE SPECIALIST PRO ELECTROSURGICAL GENERATOR	35
CLEANING	36
PERIODIC INSPECTION	36
FUSE REPLACEMENT	36
SECTION 6 - TROUBLESHOOTING	37
SECTION 7 - REPAIR POLICY AND PROCEDURES	39
RESPONSIBILITY OF THE MANUFACTURER	40
RETURNING THE ELECTROSURGICAL GENERATOR FOR SERVICE	40
Step 1 – Obtain a Returned Materials Authorization Number	40
Step 2 – Clean the Generator	40
Step 3 – Ship the Generator	40
APPENDIX A - TECHNICAL SPECIFICATIONS	41
PERFORMANCE CHARACTERISTICS	42
Input Power	42
Duty Cycle	42
Dimensions and Weight	42
Operating Parameters	42
Transport	42
Storage	42
Audio Volume	43
Return Electrode Sensing	43
Low Frequency (50-60 Hz) Leakage Current	43
High Frequency (RF) Leakage Current	44
Operating Conditions	44
STANDARDS AND IEC CLASSIFICATIONS	44
Class I Equipment (IEC 60601-1)	44
Type BF Equipment (IEC 60601-1) / Defibrillator Proof	44
Drip Proof (IEC 60601-2-2)	44
Electromagnetic Interference	44
Electromagnetic Compatibility (IEC 60601-1-2 and IEC 60601-2-2)	44
Voltage Transients (Emergency Generator Mains Transfer)	44
EMC COMPLIANCE	45
OUTPUT CHARACTERISTICS	46
Maximum Output for Monopolar and Bipolar Modes	46
OUTPUT POWER CURVES	47
APPEDIX B - WARRANTY	51

LIST OF FIGURES

Figure 2 – 1 Layout of controls, indicators, and receptacles on the front panel	16
Figure 2 – 2 Controls for the Cut and Blend Modes.....	18
Figure 2 – 3 Controls for the Coagulation, Fulguration, and Bipolar Modes	19
Figure 2 – 4 Indicators for power, return electrodes, and footswitch control	20
Figure 2 – 5 Location of the unit power switch and front panel receptacles	21
Figure 2 – 6 Layout of connectors and controls on the rear pan	22
Figure A – 1 Output voltage (V_{peak}) versus power setting (Cut, Coag).....	47
Figure A – 2 Output voltage (V_{peak}) versus power setting (Bipolar).....	47
Figure A – 3 Output power versus power setting for all modes	48
Figure A – 4 Output power vs impedance for Cut mode	48
Figure A – 5 Output power vs impedance for Blend mode.....	49
Figure A – 6 Output power versus impedance for Coagulation modes	49
Figure A – 7 Output power versus impedance for Fulguration mode	50
Figure A – 8 Output power vs impedance for Bipolar mode	50

INTRODUCING THE SPECIALIST | PRO ELECTROSURGICAL GENERATOR

This section includes the following information:

- Indications for Use
- Operating Principles
- Intended Use
- Key Features
- Components and Accessories
- Safety
- Contraindications
- Application Specification

CAUTIONS:

Read all warnings, cautions, and instructions provided with this generator before using.

Read the instructions, warnings, and cautions provided with electro-surgical accessories before using. Specific instructions are not included in this manual.

INDICATIONS FOR USE

The Specialist | PRO Electrosurgical Generator is used to deliver RF energy via an assortment of surgical devices to cut and coagulate different kinds of tissue. For the latest user information and technical bulletins, contact Symmetry Surgical.

OPERATING PRINCIPLES

The Specialist | PRO Generator is a high frequency isolated generator featuring cutting up to 120 watts, a blend mode, 2 coagulation modes and 1 bipolar mode. The generator offers a monopolar handpiece output, monopolar foot controlled output and bipolar foot controlled output.

INTENDED USE

The Specialist | PRO Electrosurgical Generator is intended to be used for all electrosurgical cut, blend, coagulation, fulguration and bipolar procedures.

NOTICE:

The Specialist | PRO is not intended for Tubal Ligation.

KEY FEATURES

The Specialist | PRO Electrosurgical Generator includes the latest technology. This unit offers unsurpassed performance, flexibility, reliability, and convenience.

It includes the following features:

- **Two levels of coagulation: Pinpoint Coagulation and Fulguration**
Pinpoint Coagulation provides precise control of bleeding in localized areas.
Fulguration provides greater control of bleeding in highly vascular tissue over broad surface areas.
- **Memory**
The unit automatically powers up to the last selected modes and power settings.
- **Isolated RF output**
This minimizes the potential of alternate site burns.
- **Standard connectors**
These connectors accept the latest monopolar and bipolar instruments.
- **Self diagnostics**
These diagnostics continually monitor the unit to ensure proper performance.
- **Return electrode sensing and contact quality monitoring**
The Specialist | PRO incorporates a return electrode contact quality monitoring system (Bovie NEM™). This system detects the type of return electrode: solid or split. The system also continually monitors the contact quality between the patient and the return electrode only when using the split return electrode. This feature is designed to minimize patient burns at the return electrode site.

NOTICES:

The Bovie NEM™ system includes alarming functionality only when using a split return electrode.

Before activation, pad placement and visual verification of the split return electrode (split pad) indicator on the front panel is recommended. After connecting the split pad to the generator and placing the split pad securely to the patient, give the unit 3 seconds to recognize the split pad. The split pad indicator will illuminate green. If the split pad and cord are attached to the generator without secure contact to the patient, the alarm indicator will illuminate red.

COMPONENTS AND ACCESSORIES

To avoid incompatibility and unsafe operation, we recommend using the following Bovie® brand accessories supplied with your generator:

- Specialist | PRO Electrosurgical Generator
- Hospital-grade power cords - 09-039-001; 09-035-001 measuring 15 feet (4.572 meters)
- User's Guide (s)
- One disposable pencil - ESRP2 reusable pencil
- Three electrodes - ES20R (ball); ES02R (needle); ES01R (blade)
- One reusable cord (A1254C) and One metal plate (A1204P)
- ESU Series I DVD

ADDITIONAL ACCESSORIES

To avoid incompatibility and unsafe operation, we recommend using the following Bovie accessories with the Specialist | PRO:

- BV-1253B - Footswitch for Monopolar and Bipolar procedures @ 10ft length
- BV-1253BL – Footswitch for Monopolar and Bipolar procedures @ 15ft length

SAFETY

The safe and effective use of electrosurgery depends to a large degree on factors solely under the control of the operator. There is no substitute for a properly trained and vigilant medical staff. It is important that they read, understand, and follow the operating instructions supplied with this electrosurgical equipment.

Veterinarians have used electrosurgical equipment safely in numerous procedures. Before starting any surgical procedure, the surgeon should be familiar with the medical literature, complications, and hazards of using electrosurgery in that procedure.

To promote the safe use of the Specialist | PRO Electrosurgical Generator, this section presents the warnings and cautions that appear throughout this user's guide. So that you can operate this equipment with maximum safety, it is important that you read, understand, and follow the instructions in these warnings and cautions. It is also important that you read, understand, and follow the instructions for use in this user's guide.

WARNINGS:

Hazardous Electrical Output - This equipment is for use only by trained, licensed veterinarians.

Danger: Fire / Explosion Hazard - Do not use the Specialist | PRO electrosurgical generator in the presence of flammable anesthetics.

Fire / Explosion Hazard - The following substances will contribute to increased fire and explosion hazards in the operating room:

- Flammable substances (such as alcohol based skin prepping agents and tinctures)
- Naturally occurring flammable gases which may accumulate in body cavities such as the bowel
- Oxygen enriched atmospheres
- Oxidizing agents (such as nitrous oxide [N₂O] atmospheres).

The sparking and heating associated with electrosurgery can provide an ignition source. Observe fire precautions at all times. When using electrosurgery in the same room with any of these substances or gases, prevent their accumulation or pooling under surgical drapes, or within the area where electrosurgery is performed.

Connect the power cord to a properly polarized and grounded power source with the frequency and voltage characteristics that match those listed on the back of the unit.

No modification of this equipment is allowed.

Electric Shock Hazard - Connect the generator power cord to a properly grounded receptacle. Do not use power plug adapters.

Electric Shock Hazard - Always turn off and unplug the generator before cleaning.

Fire Hazard - Do not use extension cords.

Patient Safety - Use the generator only if the self-test has been completed as described. Otherwise, inaccurate power outputs may result.

Due to concerns about the carcinogenic and infectious potential of electrosurgical byproducts (such as tissue smoke plume and aerosols (which may include toxic gasses and vapors, live and dead cellular material, and viruses), protective eyewear, filtration masks, and effective smoke evacuation equipment should be used in both open and laparoscopic procedures. Contact Symmetry Surgical at customerservice@symmetrysurgical.com for additional information or to inquire about our smoke evacuation solutions.

Failure of the high frequency electrosurgical equipment could result in an unintended increase of output power.

The instrument receptacles on this generator are designed to accept only one instrument at a time. Do not attempt to connect more than one instrument at a time into a given receptacle. Doing so will cause simultaneous activation of the instruments.

Use the lowest output setting necessary to achieve the desired surgical effect. Use the active electrode only for the minimum time necessary in order to lessen the possibility of unintended burn injury. Procedures performed on small anatomic structures may require reduced power settings. The higher the current flow, and the longer the current is applied, the greater the possibility of unintended thermal damage to tissue, especially during use on small structures.

For all monopolar modes, if the Generator is activated with the rated duty cycle of 10 seconds on / 30 seconds off, the surface skin temperature under the Bovie patient return pads will not rise by more than 6°C if the skin and pad are prepared properly. However, be aware that activation times longer than the rated duty cycle of 10 seconds on / 30 seconds off, particularly at high power settings, the surface skin that is under the Bovie patient return pads may continue increasing in temperature by more than 6°C.

Avoid using power settings that would exceed the highest maximum voltage that is acceptable for each accessory. Choose only accessories that will withstand each mode and power setting.

To avoid incompatibility and unsafe operation, use suitable cables, accessories, active and neutral electrodes, including values for the highest allowed H.F. peak voltage.

Some accessories have multiple buttons that can deliver different surgical effects. Verify accessory features and proper mode settings prior to activation.

Connected accessories need be rated for at least the maximum peak output voltage of the H.F. generator set at the intended output control setting in the intended operating mode.

Associated equipment and accessories used must be rated to withstand the combination of the V_{peak} rating and Crest Factor for the following RF modes, Blend, Pinpoint and Spray.

The output power selected should be as low as possible for the intended purpose. Certain devices or accessories may present a safety hazard at low power settings.

Apparent low output or failure of the Specialist | PRO to function correctly at the normal operating settings may indicate faulty application of the neutral electrode or poor contact in its connections. In this case, the application of the neutral electrode and its connections should be checked before selecting a higher output power.

When using Cut mode, associated equipment and active accessories should be selected that have a rated accessory voltage equal to or greater than 1250 V_{peak} max.

When using Blend mode, associated equipment and active accessories should be selected that have a rated accessory voltage equal to or greater than 1850 V_{peak} max.

When using Coagulation mode, associated equipment and active accessories should be selected that have a rated accessory voltage equal to or greater than 3300 V_{peak} max.

When using Fulguration mode, associated equipment and active accessories should be selected that have a rated accessory voltage equal to or greater than 3900 V_{peak} max.

When using Bipolar mode, associated equipment and active accessories should be selected that have a rated accessory voltage equal to or greater than 1200 V_{peak} max.

If the patient has an Implantable Cardioverter Defibrillator (ICD), contact the ICD manufacturer for instructions before performing an electrosurgical procedure. Electrosurgery may cause multiple activation of ICDs.

Do not use electrosurgical equipment unless properly trained to use it in the specific procedure being undertaken. Use by veterinarians without such training has resulted in serious, unintended patient injury, including bowel perforation and unintended, irreversible tissue necrosis.

For surgical procedures where the high frequency current could flow through parts of the body having a relatively small cross-sectional area, the use of bipolar techniques may be desirable to avoid unwanted coagulation.

In some circumstances, potential exists for alternate site burns at points of skin contact (e.g., between the arm and the side of the body or between leg and leg). This occurs when electrosurgical current seeks a path to the patient return electrode that includes the skin-to-skin contact point. Current passing through small skin-to-skin contact points is concentrated and may cause a burn. This is true for grounded, ground referenced, and isolated output generators.

To reduce the potential for alternate site burns, do one or more of the following:

- Avoid skin-to-skin contact points, such as fingers touching leg or leg touching leg, when positioning the patient.
- Place 5 to 8 cm (2 to 3 in.) of dry gauze or towels between contact points to ensure that contact does not occur.
- Position the patient return electrode to provide a direct current route between the surgical site and the return electrode which avoids skin-to-skin contact areas.
- In addition, place patient return electrodes according to the manufacturer's instructions.

Potential for alternate site burns increases if the return electrode is compromised.

Do not wrap the accessory cords or patient return electrode cords around metal objects. This may induce currents that could lead to shocks, fires, or injury to the patient or surgical team.

Minor neuromuscular stimulation is possible when arcs between the ACTIVE ELECTRODE and tissue occur. The generator has been designed to minimize the possibility of neuromuscular stimulation.

Accessories must be connected to the proper receptacle type. In particular, bipolar accessories must be connected to the Bipolar Instrument output jack only. Improper connection may result in inadvertent generator activation.

The use of flammable anaesthetics or oxidizing gases such as nitrous oxide (N₂O) and oxygen should be avoided if a surgical procedure is carried out in the region of the thorax or the head, unless these agents are sucked away.

Non-flammable agents should be used for cleaning and disinfection wherever possible.

Flammable agents used for cleaning or disinfecting, or as solvents of adhesives, should be allowed to evaporate before the application if HF surgery. There is a risk of pooling flammable solutions under the patient or in body depressions such as the umbilicus. Any fluids pooled in these areas should be mopped up before HF surgical equipment is used. Attention should be called to the danger of ignition of endogenous gases. Some materials, for example cotton, wool and gauze, when saturated with oxygen may be ignited by sparks produced in Normal Use of the HF surgical equipment.

The generator is equipped with a return electrode sensing and contact quality monitoring system (NEM), which monitors the quality of the patient return electrode connection. When a correctly functioning single plate return electrode is connected to the generator, the NEM (contact quality monitor) verifies the connections between the generator and the single return electrode. It DOES NOT verify that a single return electrode is in contact with the patient. When using a split return electrode, the NEM (contact quality monitor) confirms the total resistance is within the pre-set safety range. Proper application of electrodes per provided instructions and visual inspection of the patient return electrode is required for safe operation. Visual inspections should be conducted throughout the surgical procedure to ensure good contact remains, heat is not building up and adequate gel is present.

CAUTIONS:

At no time should you touch the active electrode or bipolar forceps. A burn could result.

Do not stack equipment on top of the generator or place the generator on top of electrical equipment. These configurations are unstable and/or do not allow adequate cooling.

Provide as much distance as possible between the electrosurgical generator and other electronic equipment (such as monitors). An activated electrosurgical generator may cause interference with them.

Nonfunction of the generator may cause interruption of surgery. A backup generator should be available for use.

Do not turn the activation tone down to an inaudible level. The activation tone alerts the surgical team when an accessory is active.

When using a smoke evacuator in conjunction with the electrosurgical generator, place the smoke evacuator a distance from the generator and set the generator volume control at a level that ensures that the activation tones can be heard.

The use of high frequency current can interfere with the function of other electromagnetic equipment.

When high frequency surgical equipment and physiological monitoring equipment are used simultaneously on the same patient, place any monitoring electrodes as far as possible from the surgical electrodes.

Do not use needles as monitoring electrodes during electrosurgical procedures. Inadvertent electrosurgical burns may result.

To avoid the possibility of an electrosurgical burn to either the patient or the veterinarians, do not allow the patient to come in contact with a grounded metal object or metal table during activation. When activating the unit, do not allow direct skin contact between the patient and the veterinarian without the use of gloves..

To avoid the possibility of a burn to the patient, when using a split pad do not activate the unit if the solid pad indicator is illuminated green or the red alarm indicator remains illuminated red. This could indicate improper pad placement or a faulty NEM (contact quality monitor) circuit.

Remove any loose fitting jewelry, metal tags and collars from the patient before activation.

Examine all accessories and connections to the electrosurgical generator before use. Ensure that the accessories function as intended. Improper connection may result in arcs, sparks, accessory malfunction, or unintended surgical effects.

Accessories must be connected to the proper receptacle type. In particular, bipolar accessories must be connected to the Bipolar Instrument output jack only. Improper connection may result in inadvertent generator activation.

When not using active accessories, place them in a holster or in a clean, dry, nonconductive, and highly visible area not in contact with the patient. Inadvertent contact with the patient may result in burns.

Studies have shown that smoke generated during electrosurgical procedures can be potentially harmful to patients and the surgical team. These studies recommend adequately ventilating the smoke by using a surgical smoke evacuator or other means.¹

Electrosurgical equipment and accessories are intended to be used by health professional educated in their use.

Please refer to the manufacturer of the generator for warnings, precautions, contra-indications, undesirable side-effect, measures to be taken, and limitations of use for the electrosurgical system and accessories.

1. U.S. Department of Health and Human Services. National Institute for Occupational Safety and Health (NIOSH). Control of Smoke from Laser / Electric Surgical Procedures. HAZARD CONTROLS, Publication No. 96-128, September, 1996.

CONTRAINDICATIONS

There are no known contraindications.

NOTICES

If required by local codes, connect the generator to the hospital equalization connector with an equipotential cable.

Do not clean the generator with abrasive cleaning or disinfectant compounds, solvents, or other materials that could scratch the panels or damage the generator.

Reusable devices are provided non-sterile and must be processed prior to use to include first use. Processing is defined on specific Instructions provided with each device.

Single Use Devices Only: Reusing or reprocessing single use devices may cause damage to the device which in turn may cause unnecessary harm to the user and/or patient. Reuse or reprocessing is not recommended.

After Use or upon determining product can no longer be used due to wear or damage, safely discard in accordance with established procedures for biohazardous waste.

For applicable IFU/additional information: Visit www.symmetrysurgical.com

APPLICATION SPECIFICATION

Operating Conditions

RF energy is generated and passed through an interconnecting cable to an accessory where the energy is delivered to cut, coagulate and ablate tissue.

Intended User Profile

- Education: Trained veterinarians, veterinarians assistance, clinicians
 - No maximum
- Knowledge:
 - Minimum:
 - understands electrosurgery and electrosurgical techniques
 - read and understand supplied "User's Guide" (accompanying document)
 - understands hygiene
 - No maximum
- Experience:
 - Minimum:
 - Some training on techniques or training under surveillance/supervision
 - Other: no special experience needed
 - No maximum
- Permissible impairments:
 - Mild reading vision impairment or corrected vision to 20/20
 - impaired by 40 % resulting in 60 % of normal hearing at 500 Hz to 2 kHz

Medical Purpose / Indication

- Removal and destruction of skin lesions
- Electrosurgical cutting, blending, coagulation, fulguration and bipolar procedures of tissue to aid surgeon or veterinarian in performing required procedures.

Site Condition

- Clean and protect from infection from start through completion of procedure.
- Note the follow Conditions of visibility for use:
 - Ambient luminance range: 100 lx to 1,500 lx
 - Viewing distance: 20 cm to 200 cm

Ambient luminance range	100 lx to 1,500 lx
Viewing distance	20 cm to 200 cm
Viewing angle	normal to the display $\pm 30^\circ$

Description

- The Specialist | PRO Electrosurgical Generator intended to be used for all electrosurgical cut, blend, coagulation, fulguration and bipolar procedures.
 - Viewing angle: normal to the display $\pm 30^\circ$

Site of use

- Site of use: Tissue (ligament, cartilage)

Patient population

- Age: newborn to geriatric
- Weight: >2.5 kg
- Health: no restrictions
- Species and breed: no restrictions
- Patient state: alert, relaxed maybe sedated, possible local anesthesia
 - Patient should not be User

CONTROLS, INDICATORS, AND RECEPTACLES

This section describes:















- The Front and Rear Panels
- Controls, Indicators, Receptacles, the Fuse Drawer, and Ports

FRONT PANEL

Figure 2 – 1 Layout of controls, indicators, and receptacles on the front panel



Symbols on the Front Panel

SYMBOLS	DESCRIPTION
<i>Cut Controls</i>	
	Cut Mode
	Blend Mode
<i>Coag Controls</i>	
	Coagulation Mode
	Fulguration Mod
<i>Bipolar Controls</i>	
	Bipolar mode
<i>Indicators</i>	
	Solid or metal plate Return Electrode
	Split Return Electrode
<i>Regulatory Symbology</i>	
	Mandatory: Refer to instruction manual/guide
	Defibrillator Proof Type BF Equipment
	RF Isolated – patient connections are isolated from earth at high frequency.
	Warning: Dangerous voltage.
<i>Power Switch and Handpiece Connectors</i>	
	Patient Return Electrode
	Monopolar Output
	Bipolar Output

CUT AND BLEND CONTROLS

Figure 2 – 2 Controls for the Cut and Blend Modes

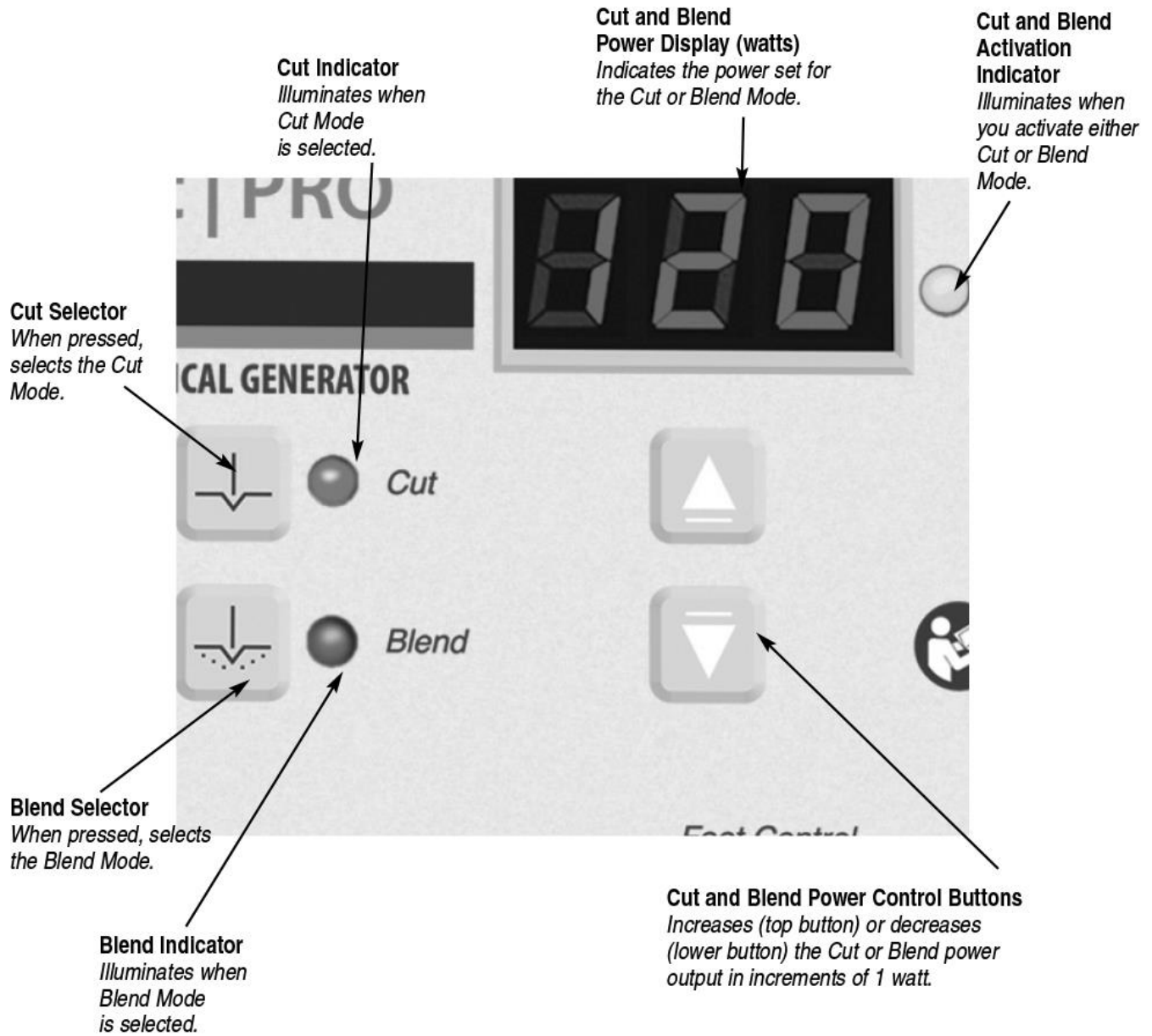

COAG AND BIPOLAR CONTROLS

Figure 2 – 3 Controls for the Coagulation, Fulguration, and Bipolar Modes

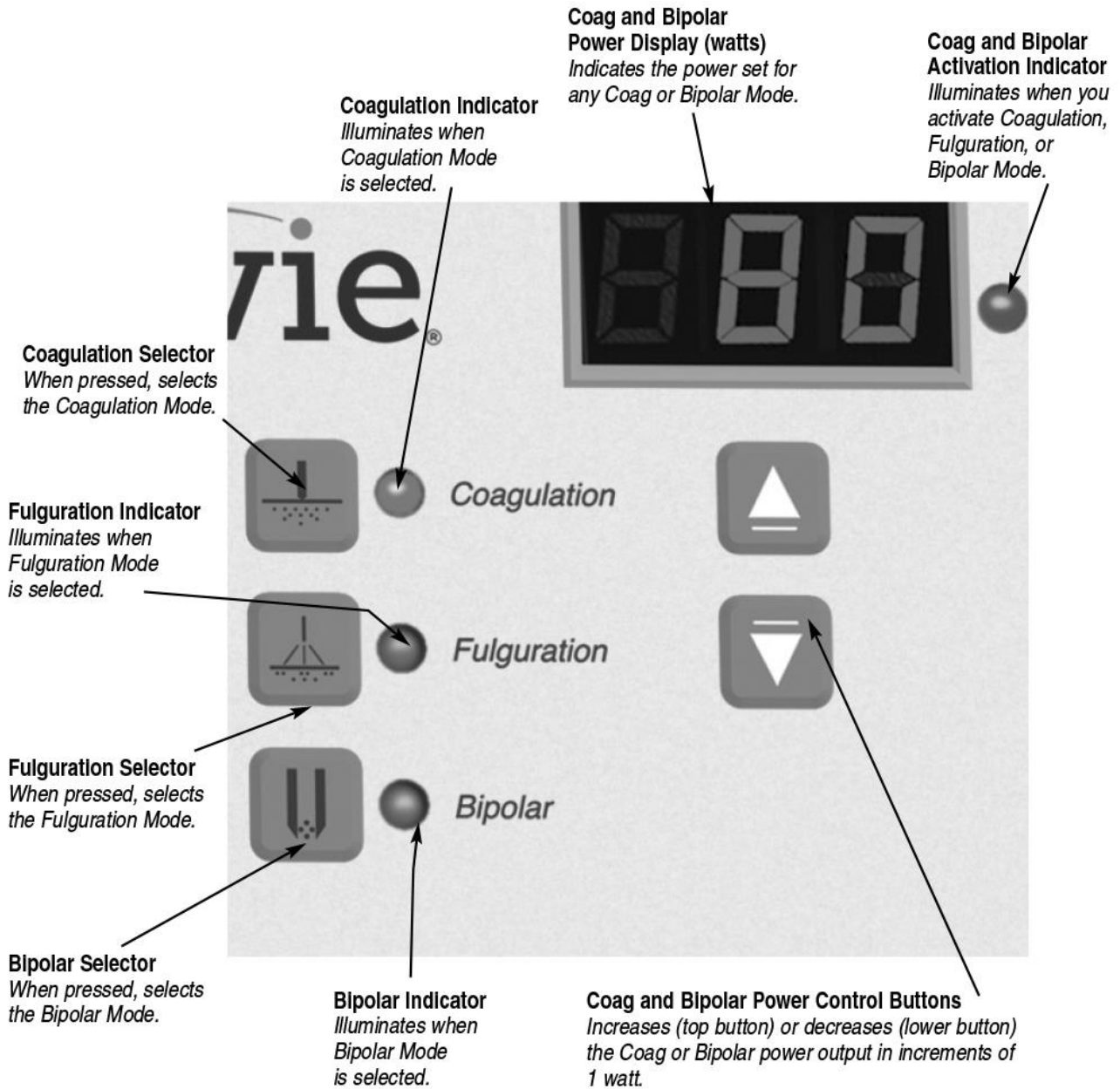

INDICATORS

Figure 2 – 4 Indicators for power, return electrodes, and footswitch control

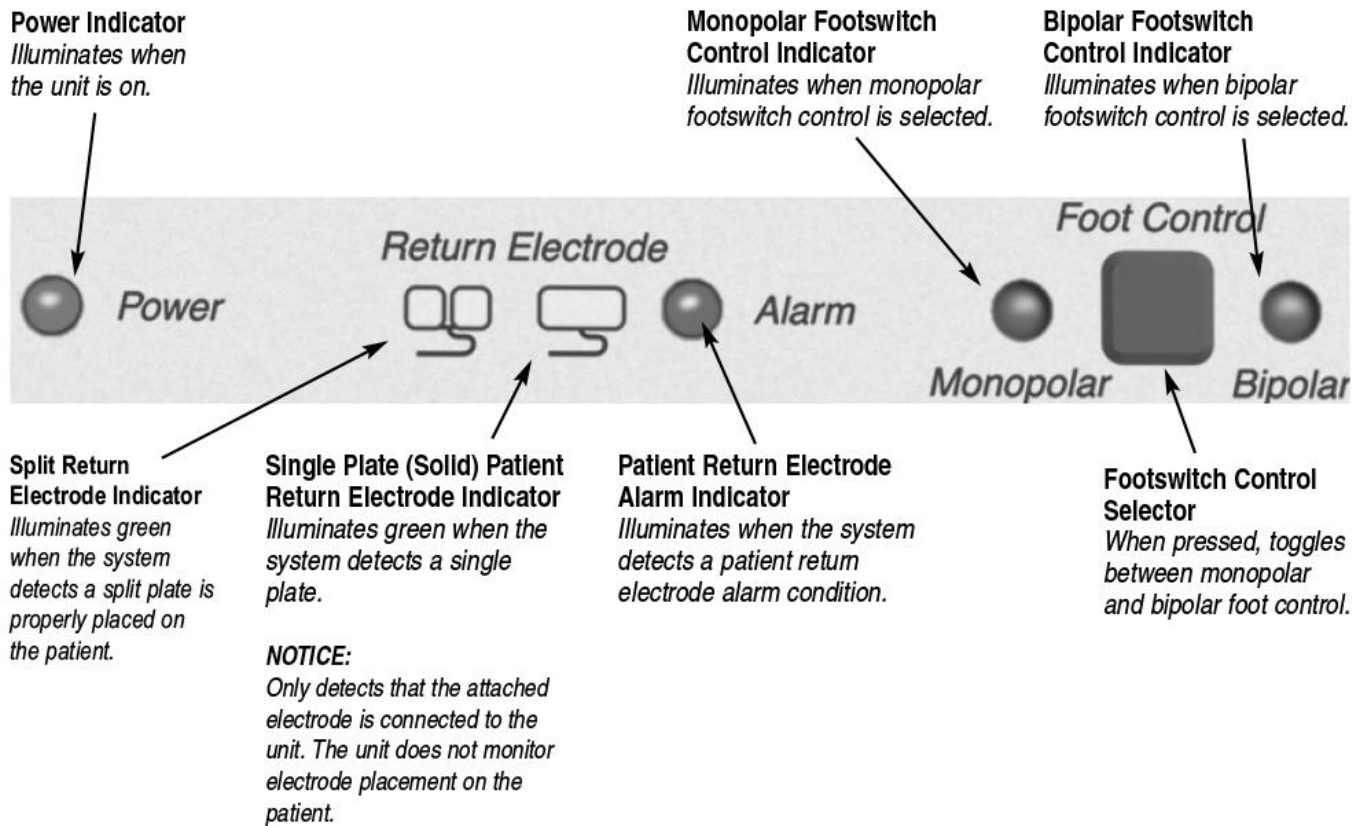

POWER SWITCH AND RECEPTACLES

Figure 2 – 5 Location of the unit power switch and front panel receptacles

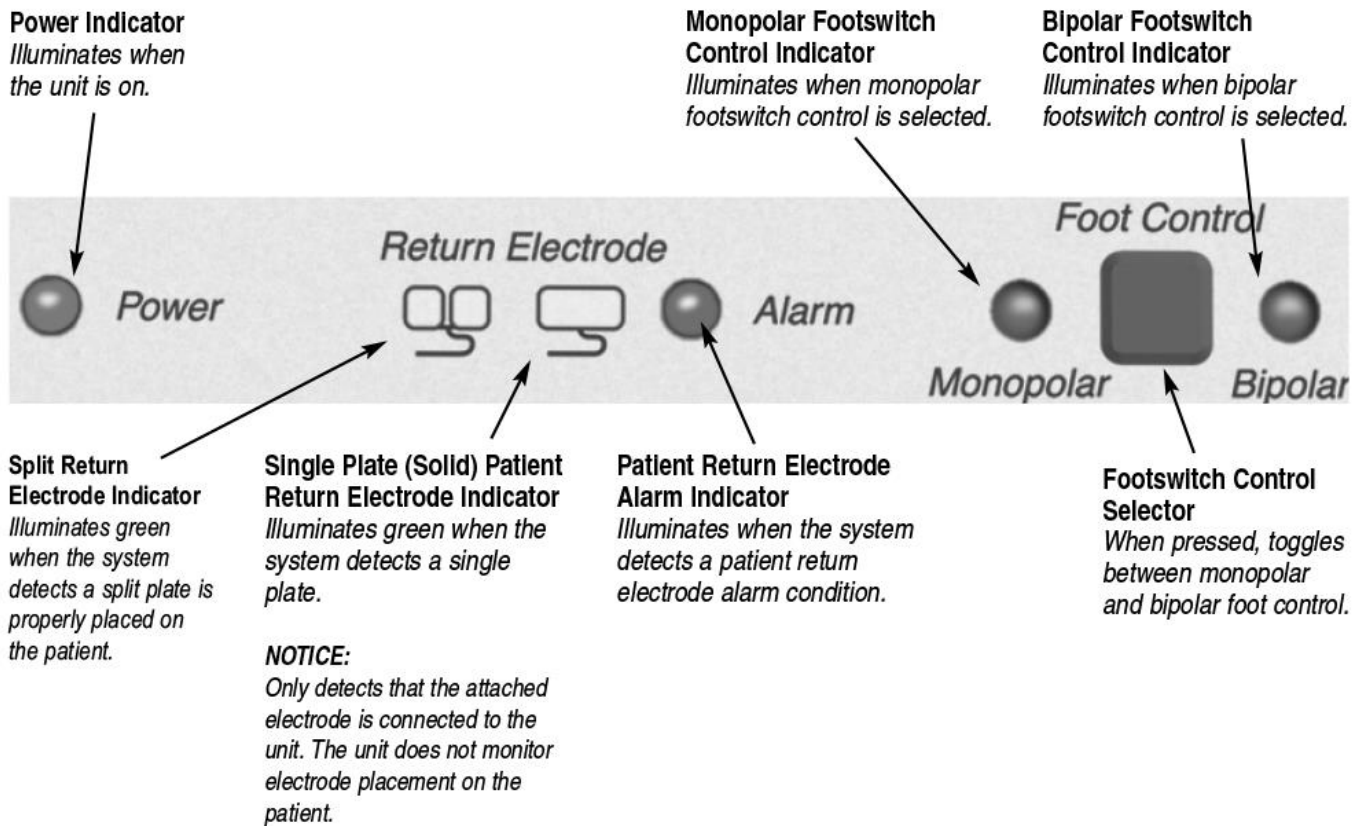

REAR PANEL

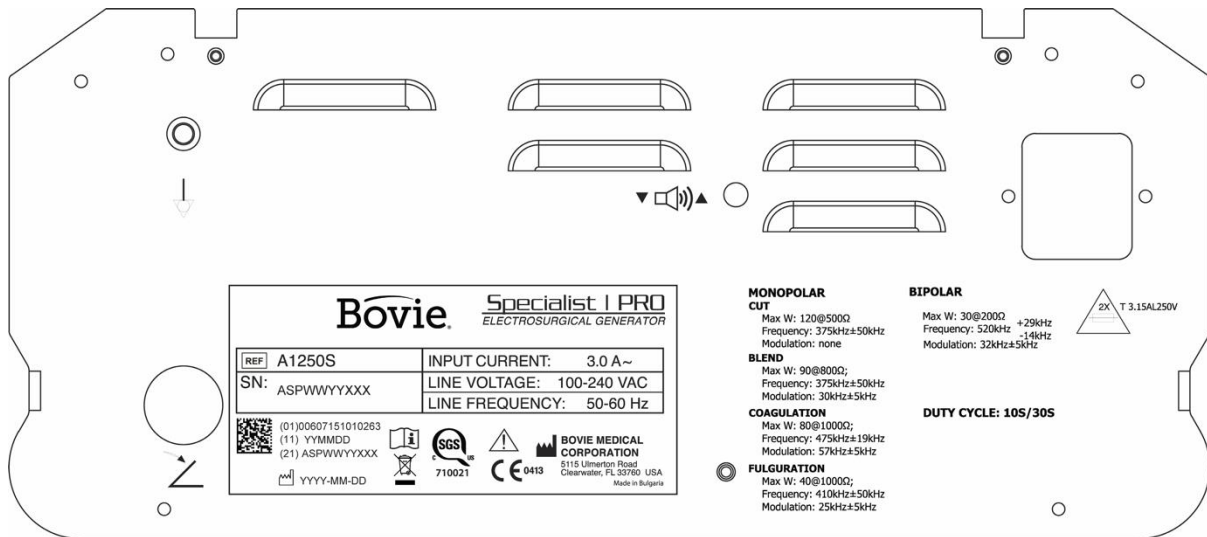

Figure 2 – 6 Layout of connectors and controls on the rear pan

Symbols on the Rear Panel

SYMBOLS	DESCRIPTION
	Equipotential Ground Stud
	Caution
	Volume Control
	Fuse Enclosed
	* Do not dispose of this device in the unsorted municipal waste stream.
	Footswitch Input Jack
	Read Instructions Before Use
	Manufacturer
	SGS Certification Mark; Conforms to PART 1 – ANSI/AAMI ES60601-1:2005 + C1:2009 + A2:2010 + A1:2012; CAN/CSA-C22.2 No. 60601-1:08 + C2:2011 PART 2 – AAMI 60601-2-2:2009 and CAN/CSA-C22.2 No. 60601-2-2:2009

NOTICE:

* Please note that infected medical devices must be disposed of as medical/biohazard waste and cannot be included in used electronic equipment disposal/recycling programs. In addition, certain electronic products must be returned directly to Symmetry Surgical. Contact your Symmetry Surgical sales representative for return instructions.

GETTING STARTED

This section includes the following information:

- Initial Inspection
- Installing the Unit
- Checking Unit Functions
- Testing Unit Performance

INITIAL INSPECTION

When you first unpack your Specialist | PRO Electrosurgical Generator, inspect it visually:

1. Look for any signs of damage.
2. Verify that the shipping package contains all items listed on the packing list.

If the unit or any accessories are damaged, notify Symmetry Surgical Customer Service immediately. Do not use any damaged equipment.

INSTALLATION

Place the Specialist | PRO Electrosurgical Generator on any flat surface with a tilt angle not more than 10 degrees. The unit relies on natural convection cooling. Do not block its bottom or rear vents. Ensure that air flows freely on all sides of the unit.

WARNING:

Connect the power cord to a properly polarized and grounded power source with the frequency and voltage characteristics that match those listed on the back of the unit.

FUNCTION CHECKS

Upon initial installation of the unit, perform the following checks. Refer to the figures in the previous chapter for the location of connectors and controls.

CAUTION:

At no time should you touch the active electrode or bipolar forceps. A burn could result.

SETTING UP THE UNIT

1. Verify that the Power Switch is in the Off position and that no accessories are connected to the unit.
2. Connect a hospital grade power cable to the AC power cable receptacle on the back of the unit, then to a properly grounded wall outlet.
3. Connect a two-pedal footswitch to the mating footswitch receptacle on the back of the unit. Only Bovie Brand footswitches are approved for use with the Specialist | PRO. Although other types of footswitches may fit, they may not be compatible.
4. Do not connect a patient return electrode at this time.
5. Turn the unit on by switching the power switch to the On position.

CHECKING THE PATIENT RETURN ELECTRODE ALARM

1. Adjust the power settings for each mode (Cut, Blend, Coagulation, Fulguration, and Bipolar) to one watt.
2. Press the Cut pedal of the footswitch. Verify that an alarm sounds for three seconds and the Patient Return Electrode Sensing Alarm Indicator Light illuminates, indicating that you connected no patient return electrode to the unit.
3. Verify that adjusting the volume control on the back of the unit while the alarm is sounding cannot change the alarm sound level.

CONFIRMING MODES

Confirm that you can select each mode and adjust the power up and down.

Checking Bipolar Mode (with Footswitch)

1. Select Bipolar mode by pressing the Bipolar Mode Selector.
2. Select Bipolar Footcontrol by pressing the Footcontrol Selector.
3. Verify that the Bipolar Mode Indicator illuminates and that the system generates the Coag tone when you press the Coag pedal on the footswitch.
4. While activating the Bipolar mode, rotate the volume control over the full range to verify that the sound is audible throughout the range.
5. Confirm that releasing the Coag pedal returns the unit to an idle state.

Checking Monopolar Mode (with Footswitch)

1. Select monopolar foot control by pressing the Footswitch Control Selector until the Monopolar Footswitch Control Indicator illuminates.
2. Connect a single-plate patient return electrode to the Return Electrode receptacle of the unit. Verify that the green single-plate patient return electrode indicator illuminates.
3. Press the Cut pedal on the footswitch. Verify that the Cut and Blend Activation Indicator illuminates and that the system generates the Cut activation tone.
4. While activating the Cut mode, rotate the volume control over the full range to verify that the sound is audible throughout the range.
5. Press the Coag pedal on the footswitch. Verify that the Coagulation, Fulguration, and Bipolar Activation Indicator illuminates and that the system generates the Coag activation tone.
6. While activating the Coag mode, rotate the volume control over the full range to verify that the sound is audible throughout the range.

Checking Monopolar Mode (with Handswitch)

1. Connect a handswitching handpiece to the Monopolar Handswitching receptacle.
2. Activate, one at a time, the Cut and Coag handswitching controls. Verify that each control causes the correct indicator and tone to sound.

PERFORMANCE CHECKS

After the unit has passed the preliminary functional test, it is ready for performance testing. A qualified biomedical engineer who is thoroughly familiar with electrosurgical devices should conduct this testing. The testing should include checking all modes of operation for proper function and power output.

USING THE SPECIALIST | PRO ELECTROSURGICAL GENERATOR

This section contains the following procedures:

- Inspecting the Generator and Accessories
- Setup Safety
- Setting Up
- Preparing for Monopolar Surgery
- Preparing for Bipolar Surgery
- Activation Safety
- Activating the Unit

CAUTIONS:

Read all warnings, cautions, and instructions provided with this generator before use.

Read the instructions, warnings, and cautions provided with electro-surgical accessories before use. Specific instructions are not included in this manual.

INSPECTING THE GENERATOR AND ACCESSORIES

Before each use of the Specialist | PRO Electrosurgical Generator, verify that the unit and all accessories are in good working order:

- Inspect for damage to the Electrosurgical Generator and all its connections.
- Verify that the appropriate power cord (110V or 220V), accessories and adapters are present.
- Inspect all cords and connectors for signs of wear, damage, and abrasion.
- Verify that no errors occur when you turn on the unit.

SETUP SAFETY

WARNINGS:

Hazardous Electrical Output - This equipment is for use only by trained, licensed veterinarians.

Electric Shock Hazard - Connect the generator power cord to a properly grounded receptacle. Do not use power plug adapters.

Connect the power cord to a properly polarized and grounded power source with the frequency and voltage characteristics that match those listed on the back of the unit.

No modification of this equipment is allowed.

Fire Hazard - Do not use extension cords.

Patient Safety - Use the generator only if the self-test has been completed as described. Otherwise, inaccurate power outputs may result.

The instrument receptacles on this generator are designed to accept only one instrument at a time. Do not attempt to connect more than one instrument at a time into a given receptacle. Doing so will cause simultaneous activation of the instruments.

Use the lowest output setting necessary to achieve the desired surgical effect. Use the active electrode only for the minimum time necessary in order to lessen the possibility of unintended burn injury. Procedures performed on small anatomic structures may require reduced power settings. The higher the current flow, and the longer the current is applied, the greater the possibility of unintended thermal damage to tissue, especially during use on small structures.

Avoid using power settings that would exceed the highest maximum voltage that is acceptable for each accessory. Choose only accessories that will withstand each mode and power setting.

To avoid incompatibility and unsafe operation, use suitable cables, accessories, active and neutral electrodes, including values for the highest allowed H.F. peak voltage.

Some accessories have multiple buttons that can deliver different surgical effects. Verify accessory features and proper mode settings prior to activation.

Connected accessories need be rated for at least the maximum peak output voltage of the H.F. generator set at the intended output control setting in the intended operating mode.

Associated equipment and accessories used must be rated to withstand the combination of the V_{peak} rating and Crest Factor for the following RF modes, Blend, Pinpoint and Spray.

If the patient has an Implantable Cardioverter Defibrillator (ICD), contact the ICD manufacturer for instructions before performing an electrosurgical procedure. Electrosurgery may cause multiple activation of ICDs.

Do not use electrosurgical equipment unless properly trained to use it in the specific procedure being undertaken. Use by veterinarians without such training has resulted in serious, unintended patient injury, including bowel perforation and unintended, irreversible tissue necrosis.

For surgical procedures where the high frequency current could flow through parts of the body having a relatively small cross-sectional area, the use of bipolar techniques may be desirable to avoid unwanted coagulation.

In some circumstances, potential exists for alternate site burns at points of skin contact (e.g., between the arm and the side of the body or between leg and leg). This occurs when electrosurgical current seeks a path to the patient return electrode that includes the skin-to-skin contact point. Current passing through small skin-to-skin contact points is concentrated and may cause a burn. This is true for grounded, ground referenced, and isolated output generators.

To reduce the potential for alternate site burns, do one or more of the following:

- Avoid skin-to-skin contact points, such as fingers touching leg or leg touching leg, when positioning the patient.
- Place 5 to 8 cm (2 to 3 in.) of dry gauze or towel between contact points to ensure that contact does not occur.
- Position the patient return electrode to provide a direct current route between the surgical site and the return electrode which avoids skin-to-skin contact areas.
- In addition, place patient return electrodes according to the manufacturer's instructions.

Potential for alternate site burns increases if the return electrode is compromised.

Do not wrap the accessory cords or patient return electrode cords around metal objects. This may induce currents that could lead to shocks, fires, or injury to the patient or surgical team.

Minor neuromuscular stimulation is possible when arcs between the ACTIVE ELECTRODE and tissue occur. The generator has been designed to minimize the possibility of neuromuscular stimulation.

Accessories must be connected to the proper receptacle type. In particular, bipolar accessories must be connected to the Bipolar Instrument output jack only. Improper connection may result in inadvertent generator activation.

The use of flammable anesthetics or oxidizing gases such as nitrous oxide (N₂O) and oxygen should be avoided if a surgical procedure is carried out in the region of the thorax or the head, unless these agents are sucked away.

Non-flammable agents should be used for cleaning and disinfection wherever possible.

Flammable agents used for cleaning or disinfecting, or as solvents of adhesives, should be allowed to evaporate before the application of HF surgery. There is a risk of pooling flammable solutions under the patient or in body depressions such as the umbilicus, and in body cavities. Any fluids pooled in these areas should be mopped up before HF surgical equipment is used. Attention should be called to the danger of ignition of endogenous gases. Some materials, for example cotton, wool and gauze, when saturated with oxygen may be ignited by sparks produced in Normal Use of the HF surgical equipment.

Proper application and visual inspection of the patient return electrode is required for safe operation. Visual inspections should be conducted throughout the surgical procedure to ensure good contact remains, heat is not building up and adequate gel is present.

Due to concerns about the carcinogenic and infectious potential of electrosurgical byproducts (such as tissue smoke plume and aerosols (which may include toxic gasses and vapors, live and dead cellular material, and viruses), protective eyewear, filtration masks, and effective smoke evacuation equipment should be used in both open and laparoscopic procedures. Contact Symmetry Surgical at customerservice@symmetrysurgical.com for additional information or to inquire about our smoke evacuation solutions.

CAUTIONS:

Do not stack equipment on top of the generator or place the generator on top of electrical equipment. These configurations are unstable and/or do not allow adequate cooling.

Provide as much distance as possible between the electrosurgical generator and other electronic equipment (such as monitors). An activated electrosurgical generator may cause interference with them.

Non-function of the generator may cause interruption of surgery. A backup generator should be available for use.

Do not turn the activation tone down to an inaudible level. The activation tone alerts the surgical team when an accessory is active.

When using a smoke evacuator in conjunction with the electrosurgical generator, place the smoke evacuator a distance from the generator and set the generator volume control at a level that ensures that the activation tones can be heard.

Electrosurgical equipment and accessories are intended to be used by health professional educated in their use.

Please refer to the manufacturer of the generator for warnings, precautions, contra-indications, undesirable side-effect, measures to be taken, and limitations of use for the electrosurgical system and accessories.

NOTICES:

If required by local codes, connect the generator to the hospital equalization connector with an equipotential cable.

Connect the power cord to a wall outlet having the correct voltage. Otherwise, product damage may result.

SETTING UP

1. Verify that the generator is Off by pressing the power switch Off (O).
2. Place the generator on a stable flat surface, such as a table, platform, or medical cart. Carts with conductive wheels are recommended. For details, refer to the procedures for your institution or to local codes. Provide at least four to six inches of space from the sides and top of the generator for cooling. Normally, the top, sides, and rear panel are warm when you use the generator continuously for extended periods of time.
3. Plug the generator power cord into the AC Power Cable Receptacle on the rear panel.
4. Plug the generator power cord into a grounded receptacle.
5. Turn on the generator by pressing the power switch On (I). Verify the following:
 - All visual indicators and displays on the front panel illuminate.
 - Activation tones sound to verify that the speaker is working properly.
6. If the self-test is successful, a tone sounds. Verify the following:
 - A Cut mode is selected; a Coag or Bipolar mode is selected.
 - Each display shows a power setting. The unit automatically powers up to the Cut and Coag modes and the last selected power settings.
 - The Patient Return Electrode Alarm Indicator illuminates red.

If the self-test is not successful, an alarm tone sounds. An error code may appear in the Cut display and/or the Coag display, in most cases, the generator is disabled. Note the error code and refer to SECTION 6, TROUBLESHOOTING.

Once the self-test is successful, connect the accessories and set the generator controls. Refer to PREPARING FOR MONOPOLAR SURGERY or PREPARING FOR BIPOLAR SURGERY later in this section.

PREPARING FOR MONOPOLAR SURGERY

Monopolar surgery requires a patient return electrode.

Applying the Return Electrode

For veterinary applications, the use of the reusable metal grounding plate and cord provided with the unit (A1254C and A1204P) is recommended. Using the metal plate with adequate application of ultrasound gel or polyhesive hydro gel will negate the requirement to shave the patient. When adequately applied, the ultrasound gel soaks thru the patients fur and provides good skin contact preventing shocks and burns.

When using metal plate, select a patient return electrode site with good blood flow. While a properly applied electrode results in minimal tissue heating beneath the electrode, a good blood flow helps carry heat away from the site.

The proper way to ground a veterinary patient using the metal plate is to:

1. Place a rubber mat on the table
2. Place two towels on the rubber mat
3. Place the metal plate on the towels
4. Put a good amount on ultrasound gel on the plate
5. Place the animal on the plate (you do not need to shave the patient).

**** If using a warming blanket***

1. Place a rubber mat on the table
2. Place your warming blanket on the rubber mat
3. Place two towels on the warming blanket
4. Place the metal plate on the towels
5. Put a good amount on ultrasound gel on the plate
6. Place the animal on the plate (you do not need to shave the patient)

If an election is made to use a sticky solid or split pad disposable return electrode, the electrode application site must be shaved so the pad can make direct skin contact. Using the disposable pads without shaving the patient increases risk of shocking of burning the patient.

If a single use sticky pad is utilized, it is recommended to use the split pads. Split pads work with the NEM circuit alarming features on the generator to alert when there is not good grounding contact and thus reduce the risk of shock or burns to the patient.

NOTICE:

The Bovie NEM™ system includes alarming functionality only when using a split return electrode.

Before activation, pad placement and visual verification of the split return electrode (split pad) indicator on the front panel is recommended. After connecting the split pad to the generator and placing the split pad securely to the patient, give the unit 3 seconds to recognize the split pad. The split pad indicator will illuminate green. If the split pad and cord are attached to the generator without secure contact to the patient, the alarm indicator will illuminate red.

Connect the cable to the Patient Return Electrode Receptacle on the front of the unit.

Connecting Accessories

1. Connect a monopolar active electrode to the unit:
2. If using a footswitch activated device, connect the footswitch (Item #'s BV-1253B or BV-1253BL) to the footswitch connecting socket on the rear of the unit.

PREPARING FOR BIPOLAR SURGERY

1. Select the Bipolar Mode, by pressing the Bipolar Mode Selector. The Bipolar Mode Indicator will illuminate.
2. Select Bipolar Footcontrol by pressing the Footcontrol Selector.
3. Connect a Bipolar cable to the Bipolar Receptacle.
4. Connect the footswitch to the footswitch connecting socket on the rear of the unit.
5. Connect a forceps instrument to the Bipolar cable.

If you are using...	Connect it to...
Standard 3-pin handswitching pencil	Monopolar Handswitching Receptacle
Footswitching pencil	Monopolar Footswitching Receptacle

ACTIVATION SAFETY

WARNINGS:

Do not wrap the accessory cords or patient return electrode cords around metal objects. This may induce currents that could lead to shocks, fires, or injury to the patient or surgical team.

Minor neuromuscular stimulation is possible when arcs between the ACTIVE ELECTRODE and tissue occur. The generator has been designed to minimize the possibility of neuromuscular stimulation.

Danger: Fire / Explosion Hazard - Do not use the Specialist | PRO in the presence of flammable anesthetics.

Fire / Explosion Hazard - The following substances will contribute to increased fire and explosion hazards in the operating room:

- Flammable substances (such as alcohol based skin prepping agents and tinctures)
- Naturally occurring flammable gases that may accumulate in body cavities such as the bowel
- Oxygen enriched atmospheres
- Oxidizing agents (such as nitrous oxide [N₂O] atmospheres).

The sparking and heating associated with electrosurgery can provide an ignition source. Observe fire precautions at all times. When using electrosurgery in the same room with any of these substances or gases, prevent their accumulation or pooling under surgical drapes, or within the area where electrosurgery is performed.

Use the lowest output setting necessary to achieve the desired surgical effect. Use the active electrode only for the minimum time necessary in order to lessen the possibility of unintended burn injury. Procedures performed on small anatomic structures may require reduced power settings. The higher the current flow, and the longer the current is applied, the greater the possibility of unintended thermal damage to tissue, especially during use on small structures.

Use electrosurgery with caution in the presence of internal or external devices such as pacemakers or pulse generators. Interference produced by the use of electrosurgical devices can cause devices such as pacemakers to enter an asynchronous mode or can block the pacemaker effect entirely. Consult the device manufacturer or hospital Cardiology Department for further information when use of electrosurgical appliances is planned for patients with cardiac pacemakers or other implantable devices.

The output power selected should be as low as possible for the intended purpose. Certain devices or accessories may present a safety hazard at low power settings.

Apparent low output or failure of the Specialist | PRO to function correctly at the normal operating settings may indicate faulty application of the neutral electrode or poor contact in its connections. In this case, the application of the neutral electrode and its connections should be checked before selecting a higher output power.

When using Cut mode, associated equipment and active accessories should be selected that have a rated accessory voltage equal to or greater than 1250 Vpeak max.

When using Blend mode, associated equipment and active accessories should be selected that have a rated accessory voltage equal to or greater than 1850 Vpeak max.

When using Coagulation mode, associated equipment and active accessories should be selected that have a rated accessory voltage equal to or greater than 3300 Vpeak max.

When using Fulguration mode, associated equipment and active accessories should be selected that have a rated accessory voltage equal to or greater than 3900 Vpeak max.

When using Bipolar mode, associated equipment and active accessories should be selected that have a rated accessory voltage equal to or greater than 1200 Vpeak max.

Due to concerns about the carcinogenic and infectious potential of electrosurgical by products (such as tissue smoke plume and aerosols (which may include toxic gasses and vapors, live and dead cellular material, and viruses), protective eyewear, filtration masks, and effective smoke evacuation equipment should be used in both open and laparoscopic procedures. Contact Symmetry Surgical at customerservice@symmetrysurgical.com for additional information or to inquire about our smoke evacuation solutions.

CAUTIONS:

The use of high frequency current can interfere with the function of other electromagnetic equipment.

When high frequency surgical equipment and physiological monitoring equipment are used simultaneously on the same patient, place any monitoring electrodes as far as possible from the surgical electrodes.

Do not use needles as monitoring electrodes during electrosurgical procedures. Inadvertent electrosurgical burns may result.

To avoid the possibility of an electrosurgical burn to either the patient or the veterinarian, do not allow the patient to come in contact with a grounded metal object or metal table during activation. When activating the unit, do not allow direct skin contact between the patient and the veterinarian without the use of gloves.

Remove any jewelry, metal tags or collars from the patient before activation.

Studies have shown that smoke generated during electrosurgical procedures can be potentially harmful to patients and the surgical team. These studies recommend adequately ventilating the smoke by using a surgical smoke evacuator or other means.¹

Examine all accessories and connections to the electrosurgical generator before use. Ensure that the accessories function as intended. Improper connection may result in arcs, sparks, accessory malfunction, or unintended surgical effects.

Accessories must be connected to the proper receptacle type. In particular, bipolar accessories must be connected to the Bipolar Instrument output jack only. Improper connection may result in inadvertent generator activation.

When not using active accessories, place them in a holster or in a clean, dry, non-conductive, and highly visible area not in contact with the patient. Inadvertent contact with the patient may result in burns.

Electrosurgical equipment and accessories are intended to be used by health professional educated in their use.

Please refer to the manufacturer of the generator for warnings, precautions, contra-indications, undesirable side-effect, measures to be taken, and limitations of use for the electrosurgical system and accessories.

1. U.S. Department of Health and Human Services. National Institute for Occupational Safety and Health (NIOSH). Control of Smoke from Laser / Electric Surgical Procedures. HAZARD CONTROLS, Publication No. 96-128, September, 1996.

ACTIVATING THE UNIT

When you turn on your unit, remember this feature:

- Specialist | PRO Electrosurgical Generator will power up to the last selected modes and power settings. For example, if you set Cut mode at 50 watts when you turned the unit off, it will automatically return to

Cut mode at 50 watts when you turn it on again. Similarly, if you set Coagulation mode at 40 watts before you turned the unit off, it will return to Coagulation mode at 40 watts when you turn it on again.

1. Monopolar Cut - Select the mode of operation for cut: Cut or Blend, then Select the desired Cut power settings by pressing the Cut and Blend Power Control Buttons.
2. Monopolar Coag - Select the mode of operation for coagulation: Coagulation or Fulguration, then Select the coagulation power settings by pressing the Coagulation, Fulguration, and Bipolar Power Control Buttons.
3. Bipolar - Select the mode of operation for Bipolar, then select the Bipolar power settings by pressing the Coagulation, Fulguration, and Bipolar Power Control Buttons.
4. Activate the generator by pressing the appropriate button. For Monopolar activation, activate the generator by pressing the appropriate handswitch button or pedal on the footswitch. For Bipolar activation, activate the generator by pressing the Coag (blue) footswitch pedal.

NOTICE

One footswitch activates either monopolar or bipolar footswitching accessories.

To Activate...	Press This...	On This Device...
Monopolar		
Cut or Blend Modes	Yellow Button Yellow Pedal	Handswitching Pencil Footswitch
Coagulation or Fulguration Modes	Blue Button Blue Pedal	Handswitching Pencil Footswitch
Bipolar		
Any Bipolar	Blue (Coag) Pedal	Footswitch

MAINTAINING THE SPECIALIST | PRO ELECTROSURGICAL GENERATOR

This section covers the following topics:

- Cleaning
- Periodic Inspection
- Fuse Replacement

Symmetry Surgical recommends that you complete periodic inspection and performance testing. Perform inspections and performance testing every six months. A qualified biomedical technician should conduct this testing to ensure that the unit is operating effectively and safely.

CLEANING

After each use, clean the unit.

WARNING:

Electric Shock Hazard - Always turn off and unplug the generator before cleaning.

NOTICE

Do not clean the generator with abrasive cleaning or disinfectant compounds, solvents, or other materials that could scratch the panels or damage the generator.

1. Turn off the generator, and unplug the power cord from the wall outlet.
2. Thoroughly wipe all surfaces of the generator and power cord with a mild cleaning solution or disinfectant and a damp cloth. Follow the procedures approved by your institution or use a validated infection control procedure. Do not allow fluids to enter the chassis. Do not sterilize the generator.

PERIODIC INSPECTION

Every six months, visually inspect the Specialist | PRO Electrosurgical Generator for signs of wear or damage. In particular, look for any of the following problems:

- Damage to the power cord
- Damage to the power cable receptacle
- Obvious damage to the unit
- Damage to any receptacle
- Accumulation of lint or debris in or around the unit.

FUSE REPLACEMENT

Fuses for the unit reside directly below the Power Cable Receptacle on the rear of the unit.

To replace the fuses, follow this procedure:

1. Unplug the power cord from the wall outlet.
2. Remove the power cord from the Power Cable Receptacle on the rear panel.
3. To release the fuse drawer, insert a small flathead screwdriver into the slot on the drawer below the power cord receptacle. Then, slide the drawer out.
4. Remove the two fuses (T3.15AL250V) and replace them with new fuses with the same values.
5. Insert the fuse holder into the Power Cable Receptacle.

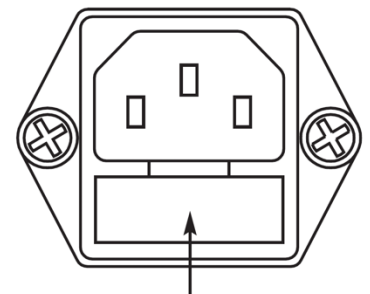

Fuse Holder

NOTICE:

If the unit does not display an error and does not power on, check fuses.

TROUBLESHOOTING

This section includes Error Code Descriptions and actions to take to resolve them.

The Specialist | PRO Electrosurgical Generator includes automatic self-diagnostics. If the diagnostics detect an error or fault, the system displays an appropriate code, sounds an audible tone, and deactivates the unit output power.

The following tables list the codes, describes the errors or faults, and recommends actions from what is listed below to take to resolve the error or fault.

If the unit displays any other error code, it requires service.

Error Code	Description	Recommended Action
F1 (on the Cut / Blend display)	Handswitch or monopolar footswitch cut pedal may be stuck.	<ol style="list-style-type: none"> 1. Turn off, then turn on the generator. Do not press buttons or activate accessory devices during the self-test. 2. If the error code reappears, disconnect all accessories. Turn off, then turn on the generator again. 3. If the problem persists, replace the handpiece or footswitch and repeat the restart. 4. If the error code reappears, record the number and call Symmetry Surgical Customer Service.
F1 (on the Coagulation / Fulguration Bipolar display)	Handswitch or monopolar footswitch coag pedal may be stuck.	
F2	Cut and Coag buttons activated simultaneously (pencil or footswitch)	The unit does not allow simultaneous activation of the cut and coagulation modes. Release either the cut or coag button on the handpiece, or the cut or coag pedal on the footswitch.
F3	Footswitch Cut (Yellow) pedal is pressed while Bipolar Mode is selected and Footswitch Control Selector is set to Bipolar Foot Control. Or, Coag (Blue) pedal is pressed while Bipolar Footswitch Control is selected and Bipolar Mode is not selected.	Use the Footswitch Control Selector to toggle and select the Bipolar Foot Control. Verify the Bipolar Footswitch Control Indicator Illuminates. Use only the Coag (Blue) pedal on the footswitch.
E4	DC voltage error	<ol style="list-style-type: none"> 1. Turn the unit off. 2. Turn the unit on. 3. If the error code reappears, record the number and contact Symmetry Surgical Customer Service.
E6	Delta error	<ol style="list-style-type: none"> 1. Turn the unit off. 2. Verify that the unit is connected to the line voltage. 3. If the error code reappears, record the number and contact Symmetry Surgical Customer Service.
E7	Internal temperature of the unit exceeded the limit.	<ol style="list-style-type: none"> 1. Turn the unit off. 2. Allow the unit to cool for 20 minutes. 3. Turn the unit on. 4. If the error code reappears, record the number and contact Symmetry Surgical Customer Service.
E8	Connector Sense Error The unit shall monitor the connection of the main cable between the main and display boards.	<ol style="list-style-type: none"> 1. If this cable becomes disconnected an E8 error shall occur and be displayed. 2. The unit cannot be activated while the error condition is present. 3. The unit has to be reset to remove the error condition.

NOTICE:

If the unit does not power on to display an error, check fuses as described in Section 5 of this guide.

REPAIR POLICY AND PROCEDURES

Refer to this section for information on:

- The Manufacturer's Responsibility
- Returning the Generator for Service
- Returning Circuit Boards
- Finding Service Centers

RESPONSIBILITY OF THE MANUFACTURER

Symmetry Surgical is responsible for the safety, reliability, and performance of the generator only under the following circumstances:

- The user has followed the Installation and Setup Procedures in this User manual.
- Persons authorized by Symmetry Surgical performed assembly operation, readjustments, modifications, or repairs.
- The electrical installation of the relevant room complies with local codes and regulatory requirements, such as IEC and BSI.
- Equipment use is in accordance with the Symmetry Surgical instructions for use.

For warranty information, refer to APPENDIX B - WARRANTY.

RETURNING THE ELECTROSURGICAL GENERATOR FOR SERVICE

Before you return the generator, contact Symmetry Surgical Customer Service for assistance. If instructed to send the generator to Symmetry Surgical, first obtain a Returned Materials Authorization Number. Then clean the Generator and ship it to Symmetry Surgical for service.

Step 1 – Obtain a Returned Materials Authorization Number

Call the Symmetry Surgical Customer Service to obtain a Returned Materials Authorization Number. Have the following information ready when you call:

- Hospital / clinic name / veterinarian name
- Distributor whom purchased from
- Telephone number
- Department / address, city, state, and zip code
- Model number
- Serial number / Lot number
- Description of the problem
- Type of repair to be done

Step 2 – Clean the Generator

WARNING:

Electric Shock Hazard - Always turn off and unplug the generator before cleaning.

NOTICE

Do not clean the generator with abrasive cleaning or disinfectant compounds, solvents, or other materials that could scratch the panels or damage the generator.

- A. Turn off the generator, and unplug the power cord from the wall outlet.
- B. Thoroughly wipe all surfaces of the generator and power cord with a mild cleaning solution or disinfectant and a damp cloth. Follow the procedures approved by your institution or use a validated infection control procedure. Do not allow fluids to enter the chassis. You cannot sterilize the generator.

Step 3 – Ship the Generator

- A. Attach a tag to the generator that includes the Returned Materials Authorization Number and the information (hospital, phone number, etc.) listed in Step 1 – Obtain a Returned Materials Authorization Number.
- B. Be sure the generator is completely dry before you pack it for shipment. Package it in its original shipping container, if available.
- C. Ship the generator, prepaid, to the address given to you by Symmetry Surgical Customer Service.



TECHNICAL SPECIFICATIONS

All specifications are nominal and subject to change without notice. A specification referred to as “typical” is within $\pm 20\%$ of a stated value at room temperature (25° C / 77° F) and a nominal input power voltage.

PERFORMANCE CHARACTERISTICS

Input Power

100 – 240 VAC
Mains line frequency range (nominal): 50 – 60 Hz
Power consumption: 270 VA
Fuses (two): 3.15A (Slow Blow)

Duty Cycle

Under maximum power settings and rated load conditions (Cut, 120 watt @ 500 ohm load), the generator is suitable for activation times of 10 seconds on, 30 seconds off for one hour.

The internal temperature of the unit is continuously monitored. If the temperature rises above 85°C, the alarm will sound and output power will be deactivated.

Dimensions and Weight

Width	26 cm (10.25 in.)	Depth	30.5 cm (12 in.)
Height	15.2 cm (6 in.)	Weight	< 4 kg (< 9 lbs)

Operating Parameters

Ambient temperature range	10° to 40° C (50° to 104° F)
Relative humidity	30% to 75%, non-condensing
Atmospheric pressure	70kPa to 106kPa
Warm-up time	If transported or stored at temperatures outside the operating temperature range, allow one hour for the generator to reach room temperature before use.

Transport

Ambient temperature range	-40° to +70° C
Relative humidity	10% to 100%, including condensation
Atmospheric pressure	50kPa to 106kPa

Storage

Ambient temperature range	10° to 30° C (68° to 86° F)
Relative humidity	10% to 75%, non-condensing
Atmospheric pressure	50kPa to 106kPa

Audio Volume

The audio levels stated below are for activation tones (bipolar, cut and coag) and alarm tones (return electrode and system alarms) at a distance of one meter. Alarm tones meet the requirements for IEC 60601-2-2.

Activation Tone

Volume (adjustable)	40 to \geq 65 dBA
Frequency	Cut: 610 Hz \pm 10 Hz Blend: 610 Hz \pm 10 Hz Pinpoint: 840 Hz \pm 10 Hz Spray: 840 Hz \pm 10 Hz Bipolar: 840 Hz \pm 10 Hz
Duration	Continuous while the generator is activated

Alert Tone

Volume (not adjustable)	65 dBA at a distance of one meter
Frequency	2.44 kHz / 450 ms / 1.22 kHz / 450 ms

Return Electrode Sensing

The system presents audible and visible alarms when it senses no return electrode.

Single Plate	Trip resistance: 0 Ω to 8 Ω \pm 1 Ω Continuous measurement: Once the system establishes the single-plate electrode resistance, an increase of 20 Ω \pm 25 Ω in resistance will cause an alarm. When the alarm condition exists, the system deactivates output power.
Split Plate	Trip resistance: 10 Ω \pm 5 Ω to 135 Ω \pm 10 Ω Continuous measurement: Once the system establishes the split-plate electrode resistance, an increase of (35 \pm 5)% in resistance will cause an alarm. When the alarm condition exists, the system deactivates output power.

Low Frequency (50-60 Hz) Leakage Current

Enclosure source current, ground open	< 500 μ A 220 - 240 VAC
	< 300 μ A 90 - 120 VAC
Source current, patient leads, all outputs	Normal polarity, intact ground: < 10 μ A Normal polarity, ground open: < 50 μ A Reverse polarity, ground open: < 50 μ A
Sink current at high line, all inputs	< 50 μ A

High Frequency (RF) Leakage Current

Bipolar RF leakage current	< 39 mA _{rms}
Monopolar RF leakage current (additional tolerance)	< 150 mA _{rms}

Operating Conditions

RF energy is generated and passed through an interconnecting cable to an accessory where the energy is delivered to cut, coagulate and ablate tissue.

STANDARDS AND IEC CLASSIFICATIONS

Class I Equipment (IEC 60601-1)

Accessible conductive parts cannot become live in the event of a basic insulation failure because of the way in which they are connected to the protective earth conductor.

Type BF Equipment (IEC 60601-1) / Defibrillator Proof



The Specialist | PRO provides a high degree of protection against electric shock, particularly regarding allowable leakage currents. It is type BF equipment. Patient connections are isolated from earth and resist the effects of defibrillator discharge.

Drip Proof (IEC 60601-2-2)

The generator enclosure is constructed so that liquid spillage in normal use does not wet electrical insulation or other components which, when wet, are likely to affect adversely the safety of the generator.

Electromagnetic Interference

When other equipment is placed on or beneath an activated Specialist | PRO, the unit can be activated without interference. The generator minimizes electromagnetic interference to video equipment used in the operating room.

Electromagnetic Compatibility (IEC 60601-1-2 and IEC 60601-2-2)

The Specialist | PRO complies with the appropriate IEC 60601-1-2 and IEC 60601-2-2 specifications regarding electromagnetic compatibility.

Voltage Transients (Emergency Generator Mains Transfer)

The Specialist | PRO operates in a safe manner when the transfer is made between line AC and an emergency generator voltage source.

EMC COMPLIANCE

Special precautions should be taken regarding the Specialist | PRO. Medical Electrical Equipment needs special precautions regarding EMC and needs to be installed and put into service according to the EMC information provided in this manual.

WARNINGS:

Use of this equipment adjacent to or stacked with other equipment should be avoided because it could result in improper operation. If such use is necessary, this equipment and other equipment should be observed to verify that they are operating normally.

Use of accessories and cables other than those specified or provided by the manufacturer of this equipment could result in increased electromagnetic emissions or decreased electromagnetic immunity of this equipment and result in improper operation.

Portable RF communications (including peripherals such as antenna cables and external antennas) should be used no closer than 30 cm (12 inches) to any part of the Specialist | Pro, including cables specified by Symmetry Surgical. Otherwise, degradation of the performance of Specialist | Pro could result.

Understand that only the Accessories supplied with or ordered from Symmetry Surgical should be used with your device. The Specialist | Pro and its accessories are not suitable for interconnection with other equipment.

The Specialist | Pro is suitable for use in all establishments other than domestic and those directly connected to the public low-voltage power supply network that supplies buildings used in domestic purposes.

For the purposes of EN60601-1-2 the Specialist | Pro has an essential performance which is that there shall be no component failure, change in operating mode or false alarm, the delivered power shall remain within +/-20% of the set power and there shall be no reset or interruption of the HF power unless this is clearly indicated on the product.

The Specialist | Pro must emit electromagnetic energy in order to perform its intended function. Nearby electronic equipment may be affected.

The Specialist | Pro is intended for use in the electromagnetic environment listed below. The customer or the user of the Specialist | Pro should assure that it is used in such an environment. - electromagnetic emissions

Emissions test	Compliance	Electromagnetic environment – guidance
RF Emissions CISPR 11	Group 2	The Specialist Pro must emit electromagnetic energy in order to perform its intended function. Nearby electronic equipment may be affected.
RF Emissions CISPR 11	Class A	The Specialist Pro is suitable for use in all establishments other than domestic and those directly connected to the public low-voltage power supply network that supplies buildings used in domestic purposes.
Harmonic emissions IEC 61000-3-2	Class A	
Voltage fluctuations/flicker emissions IEC 61000-3-3	Complies	

NOTICE

The EMISSIONS characteristics of this equipment make it suitable for use in industrial areas and hospitals (CISPR 11 class A). If it is used in a residential environment (for which CISPR 11 class B is normally required) this equipment might not offer adequate protection to radio-frequency communication services. The user might need to take mitigation measures, such as relocating or re-orienting the equipment.

The Specialist | Pro is intended for use in the electromagnetic environment listed below. The customer or the user of the Specialist | Pro should assure that it is used in such an environment. - electromagnetic immunity

Immunity Test	Compliance Test Level
IEC 61000-4-2, Electro-Static Discharge	8kV Contact 15kV Air
IEC 61000-4-3, Radiated Immunity	10V/m 80MHz – 1000MHz 10V/m 1.4GHz – 2.7GHz(1)
IEC 61000-4-4, Electric Fast Transients Immunity IEC 61000-3-2	2kV, AC Mains
IEC 61000-4-5, Surge Immunity	1kV Line-Line 2kV Line-PE
IEC 61000-4-6, Conducted Immunity	6Vrms, 150kHz – 80MHz
RIEC 61000-4-8, Power Frequency Magnetic Field Immunity	30A/m, 50 and 60Hz
IEC 61000-4-11, Voltage Dips & Interruptions	<5 % UT (>95 % dip in UT) for 0,5 cycle and 1.0 cycle 70 % UT (30 % dip in UT) for 25/30 cycles <5 % UT (>95 % dip in UT) for 250/300 cycles

OUTPUT CHARACTERISTICS

Maximum Output for Monopolar and Bipolar Modes

Power readouts agree with actual power into rated load to within 20% or 5 watts, whichever is greater.

Mode	Output Power	Output Frequency	Repetition Rate	Open Circuit Vpeak max	Crest Factor* (Rated Load)
Cut	120 W @ 500 Ω	357 kHz ± 50 kHz	N/A	1250V	2.9 ± 20%
Blend	90 W @ 800 Ω	357 kHz ± 50 kHz	30 kHz ± 5 kHz	1850V	3.3 ± 20%
Coagulation	80 W @ 1000 Ω	475 kHz ± 19 kHz	57 kHz ± 5 kHz	3300V	5.5 ± 20%
Fulguration	40 W @ 1000 Ω	410 kHz ± 50 kHz	25 kHz ± 5 kHz	3900V	7.7 ± 20%
Bipolar	30 W @ 200 Ω	520 kHz (-14 kHz, +29 kHz)	32 kHz ± 5 kHz	1200V	6.9 ± 20%

* an indication of a waveform's ability to coagulate bleeders without a cutting effect

OUTPUT POWER CURVES

Figure A-1 and A-2 illustrates output voltage (Vpeak) versus power setting. Figure A-3 illustrates output power versus power setting for all modes. Figures A-4 through A-8 illustrate specific output power delivered to a range of load resistances for each mode.

Figure A – 1 Output voltage (Vpeak) versus power setting (Cut, Coag)

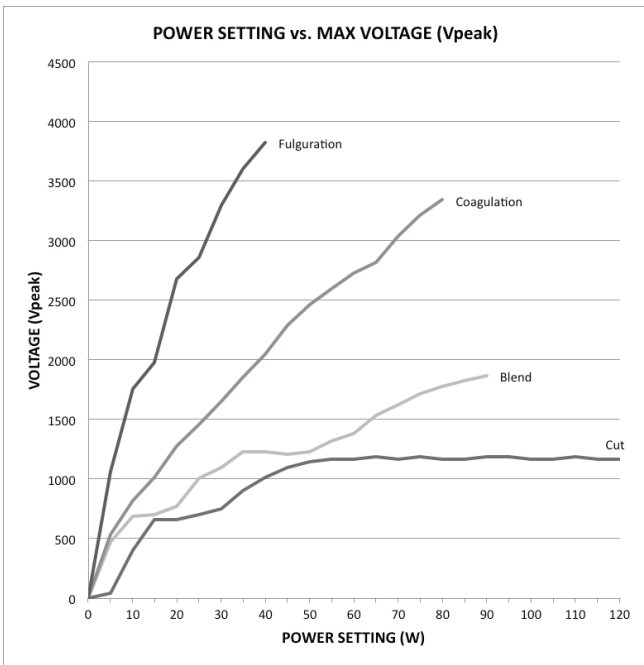

Figure A – 2 Output voltage (Vpeak) versus power setting (Bipolar)

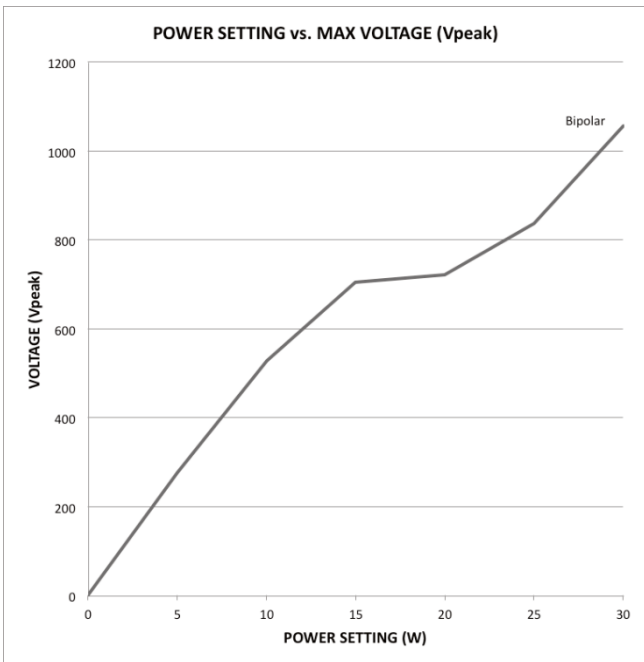

Figure A – 3 Output power versus power setting for all modes

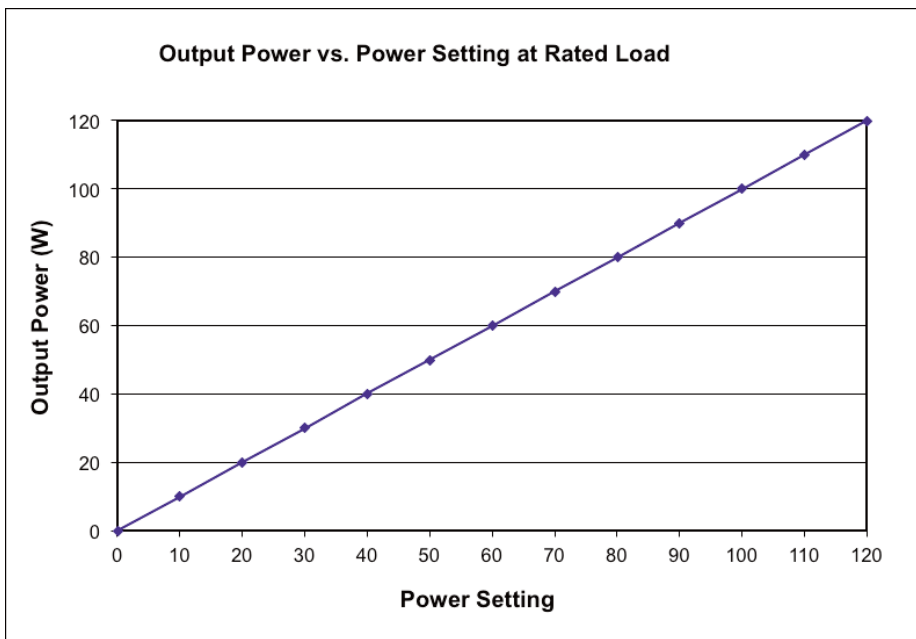

Figure A – 4 Output power vs impedance for Cut mode

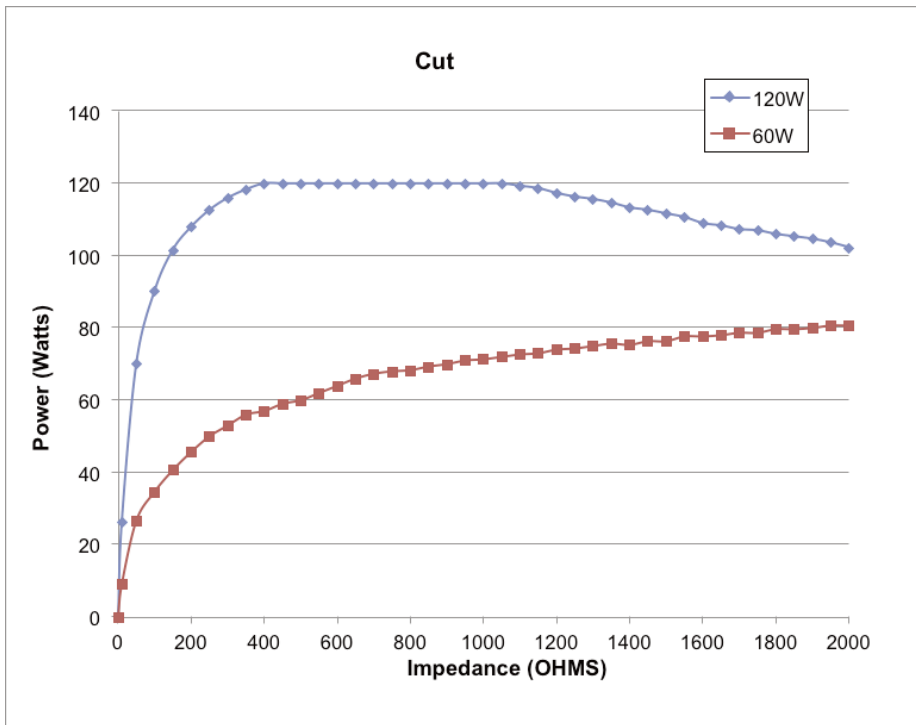

Figure A – 5 Output power vs impedance for Blend mode

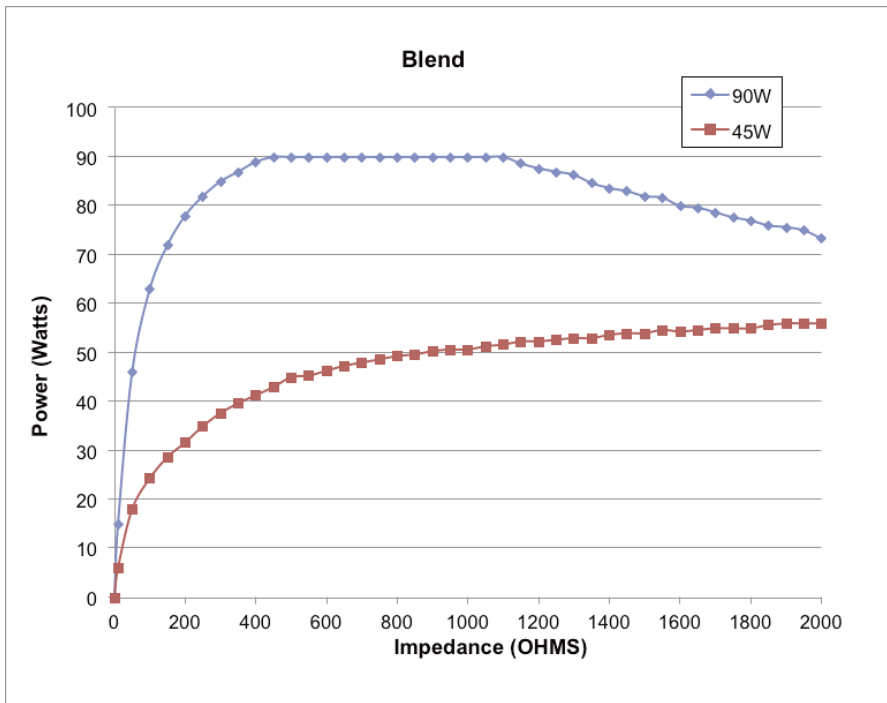

Figure A – 6 Output power versus impedance for Coagulation modes

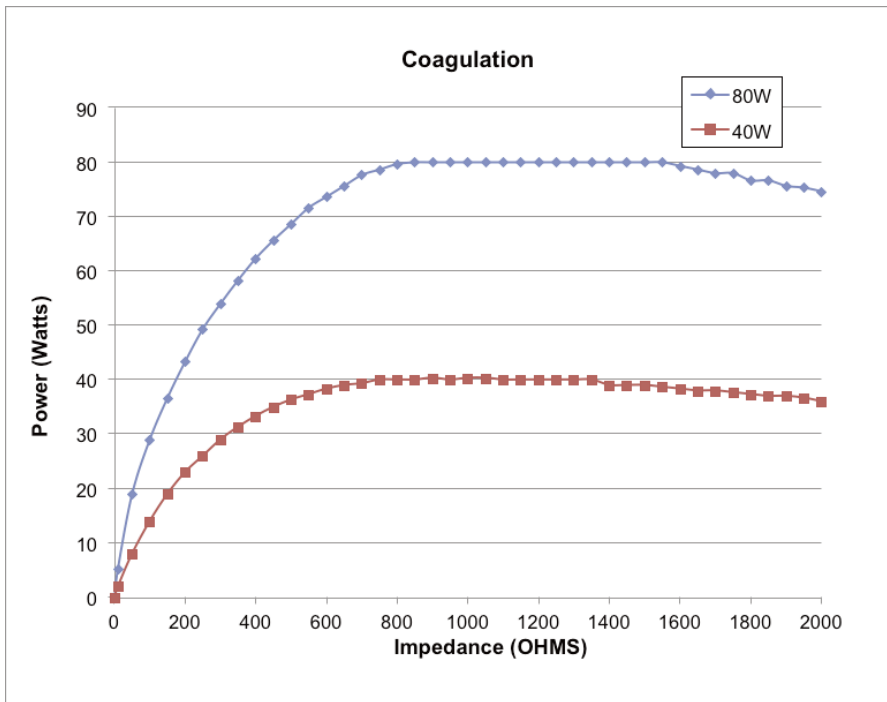

Figure A – 7 Output power versus impedance for Fulguration mode

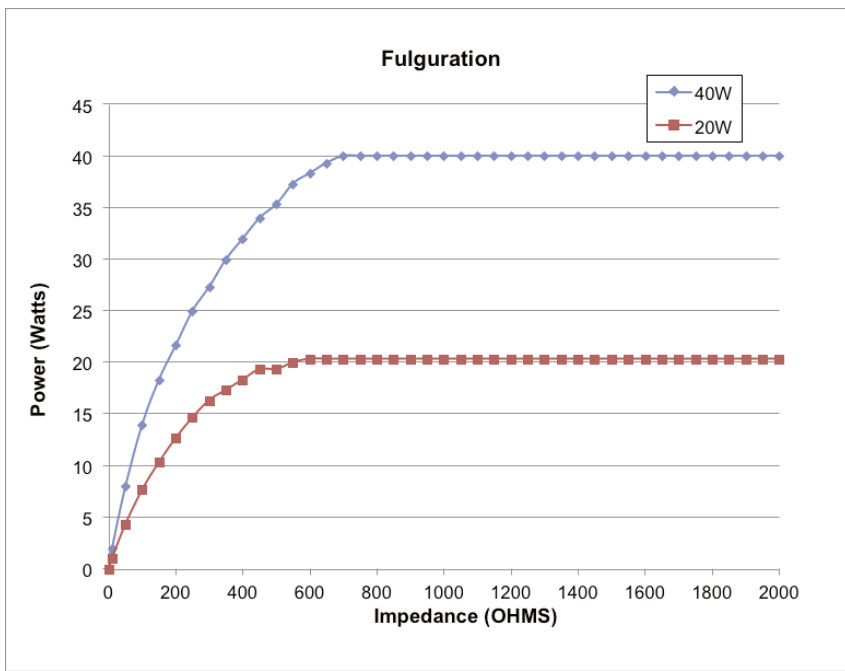
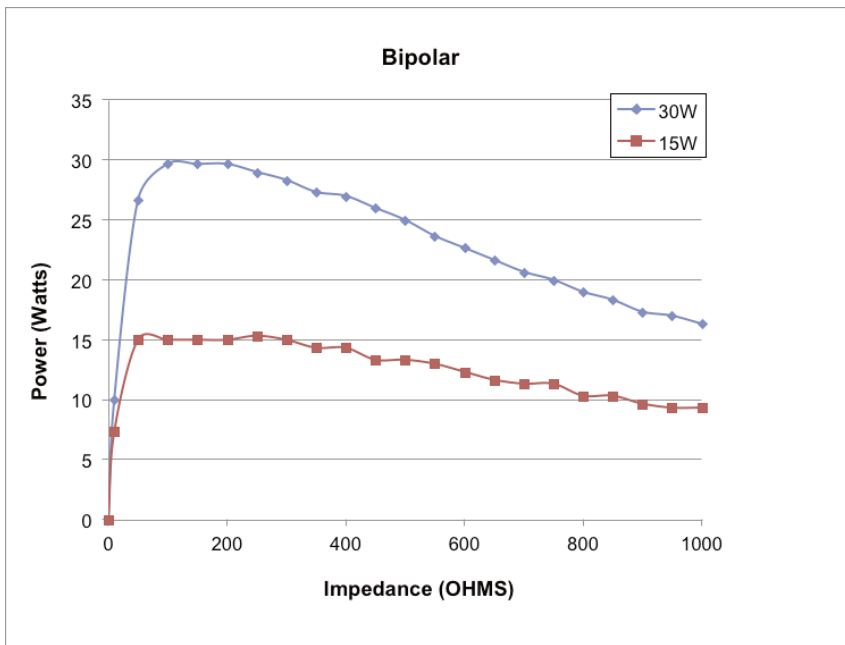

Figure A – 8 Output power vs impedance for Bipolar mode





WARRANTY

Symmetry Surgical, warrants each product manufactured by it to be free from defects in material and workmanship under normal use and service for the period(s) set forth below.

Symmetry Surgical's obligation under this warranty is limited to the repair or replacement, at its sole option, of any product, or part thereof, which has been returned to it or its Distributor within the applicable time period shown below after delivery of the product to the original purchaser, and which examination discloses, to Symmetry Surgical's satisfaction, that the product is indeed, defective.

This warranty does not apply to any product, or part thereof, which has been repaired or altered outside Symmetry Surgical's factory in a way so as, in Symmetry Surgical's judgment, to affect its stability or reliability, or which has been subjected to misuse, neglect, or accident.

The warranty periods for Symmetry Surgical products are as follows:

- Electrosurgical Generators: Four years from date of shipment
- Mounting Fixtures (all models): Two years from date of shipment
- Footswitches (all models): One year from date of shipment
- Patient Return Electrodes: Shelf life only as stated on packaging
- Sterile Single Use Accessories: Only as stated on packaging
- Handpiece: Only as stated on packaging

This warranty is in lieu of all other warranties, express or implied, including without limitation, the warranties of merchantability and fitness for a particular purpose, and of all other obligations or liabilities on the part of Symmetry Surgical.

Symmetry Surgical neither assumes nor authorizes any other person to assume for it any other liability in connection with the sale or use of any of Symmetry Surgical's products.

Notwithstanding any other provision herein or in any other document or communication, Symmetry Surgical's liability with respect to this agreement and products sold hereunder shall be limited to the aggregate purchase price for the goods sold by Symmetry Surgical to the customer.

Symmetry Surgical disclaims any liability hereunder or elsewhere in connection with the sale of this product, for indirect or consequential damages.

This warranty and the rights and obligations hereunder shall be construed under and governed by the laws of the State of Tennessee, USA.

The sole forum for resolving disputes arising under or relating in any way to this warranty is the Federal District Court serving Davidson County Tennessee, USA.

Symmetry Surgical, its dealers, and representatives reserve the right to make changes in equipment built and/or sold by them at any time without incurring any obligation to make the same or similar changes on equipment previously built and/or sold by them.



Bovie[®]

**Bovie Medical Corporation
USA**

www.symmetrysurgical.com

customerservice@symmetrysurgical.com

U.S. & CA 1 800 251-3000

EMEA & LATAM +1 615-964-5532

ASIA & AUS/NZ +61 3 9413 555

MC-55-240-001_3

10/2022