



Scan the code above to learn more about our Obese Patient Solutions portfolio.

Obese Patient Solutions Portfolio

Symmetry Surgical has a broad portfolio of surgical instruments designed specifically for large or obese patients. Our extended-length instruments span all specialties and give surgeons additional reach to aid in completion of procedures.



symmetry surgical™

Obese Patient Solutions

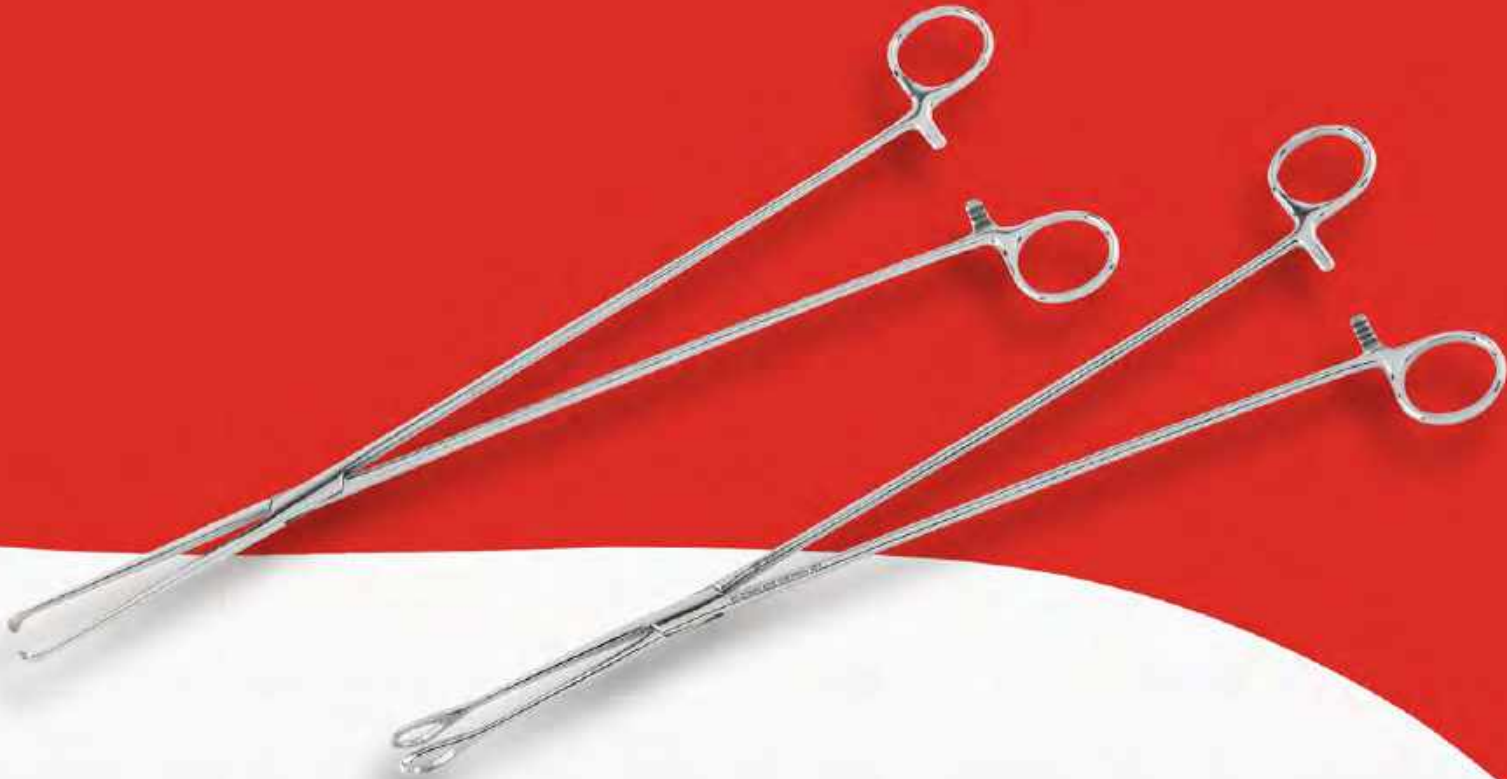

Aspirators	OBE-2	Needle Holders	OBE-38
Chisels	OBE-2	Osteotomes	OBE-41
Clamps	OBE-3	Pliers	OBE-42
Containers	OBE-8	Probes	OBE-42
Curettes	OBE-9	Retractors	OBE-43
Dissectors	OBE-19	Rongeurs	OBE-67
Elevators	OBE-20	Scissors	OBE-71
Forceps	OBE-23	Shears	OBE-77
Gouges	OBE-34	Spatulas	OBE-78
Hooks	OBE-34	Spreaders	OBE-79
Knife Handles	OBE-36	Suction Tubes	OBE-79
Laparoscopic	OBE-37		

Questions? Contact us at customerservice@symmetrysurgical.com
or learn more at symmetrysurgical.com



The Surgical Instrument Desk Reference

How to Use Our Catalog

The Symmetry Surgical catalog is designed with you in mind, to be your trusted resource for surgical instrumentation. We took great care in creating an easy-to-use, robust catalog and we think you'll be pleased with the design as you become more familiar with our broad portfolio.

Layout

The catalog is organized by surgical specialty *and* product function.

And we know that it is difficult to pick up an instrument and know what specialty it's listed in. To make your job easier, we've sorted the instruments in our portfolio by surgical function, too, including Energy, Laparoscopic, Retractors and Sterilization Solutions.

U.S. Customer Service

Your Symmetry Surgical Customer Service team wants to make ordering surgical instruments the easiest part of your day. We accept orders via phone, fax, email, our website, Global Healthcare Exchange (GHX) and through the mail.

PHONE

1.800.251.3000

(Available Monday through Friday, 8:30 AM–6:30 PM EST)

FAX

1.800.342.3272

EMAIL

customerservice@symmetrysurgical.com

ONLINE

symmetrysurgical.com

MAILING ADDRESS

Symmetry Surgical
Attn: Customer Service
3034 Owen Drive
Antioch, TN 37013

The Surgical Instrument Desk Reference

International Customer Service

PHONE

Symmetry Surgical Switzerland GmbH
+41 (0) 52 557 59 00
(Available Monday through Friday, 7:00-16:00 GMT)

Symmetry Surgical, Inc., USA
1.615.964.5672
(Available Monday through Friday, 8:30 AM–6:30 PM EST)

FAX

Symmetry Surgical Switzerland GmbH
+41 (0) 52 557 59 99

EMAIL

customerservice@symmetrysurgical.com
internationalorders@symmetrysurgical.com

ONLINE

symmetrysurgical.com

MAILING ADDRESS

Symmetry Surgical Switzerland GmbH
Bühlstrasse 27
CH-8200 Schaffhausen
Switzerland

Symmetry Surgical, Inc.
3034 Owen Drive
Antioch, TN 37013

INTERNATIONAL PAYMENT TERMS/RETURN GOODS POLICY/INSTRUMENT REPAIR & RESTORE PROGRAM/LITERATURE REQUESTS

Please contact your local distributor. Locate a local distributor contact, International Customer Service at +41 (0) 52 557 59 00 or 1.615.964.5672 (US).

Cardiovascular/Thoracic

Energy

Ear, Nose & Throat

General

Laparoscopic

Neurology

Obesity

OB/GYN

Ophthalmology

Orthopedics & Arthroscopy

Pediatrics

Rectal

Retractors

Spine

Urology

Sterilization Solutions

Alphabetical & Numeric Indexes

OBESE PATIENT

Aspirators (Needle)

Needle Aspirator

CODE	DESCRIPTION	LENGTH
90-5051L	15 Gauge	17 ³ / ₄ in 450 mm
90-5052L	22 Gauge	17 ³ / ₄ in 450 mm

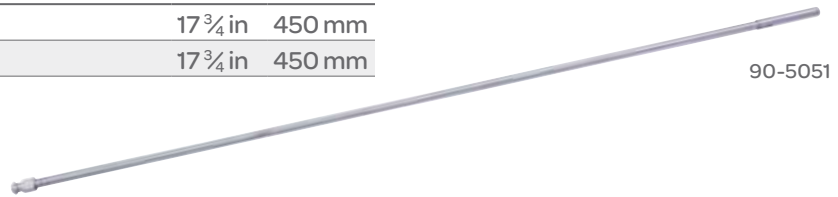

90-5051

Chisels

Chisel

CODE	DESCRIPTION	TIP WIDTH	LENGTH
67-7018	Straight Stiletto	³ / ₄ in 20 mm	9 ¹ / ₂ in 241 mm

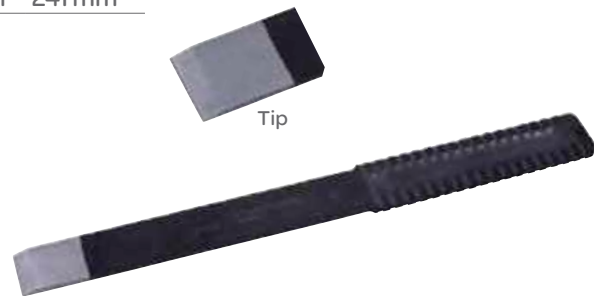

Tip

Puka Chisel

CODE	DESCRIPTION	TIP WIDTH	LENGTH
67-7003	#2	³ / ₈ in 10 mm	11 in 279 mm



Chisels (Spinal)

Spinal Fusion Chisel

CODE	DESCRIPTION	TIP WIDTH	BLADE WIDTH	LENGTH
18-1011	Straight	6 mm	¹⁵ / ₆₄ in	9 ¹ / ₂ in 241 mm
67-7001	Straight	6 mm	¹⁵ / ₆₄ in	10 ¹ / ₂ in 267 mm



67-7001

Clamps (Anastomosis)

Clamp Cooley Classic® Anastomosis Clamp

Serration Markings, 2.5 mm, 2x2 Teeth

CODE	DESCRIPTION	LENGTH
67-7567	Small Jaw	12 in 305 mm
677564	Medium Jaw	12 in 305 mm

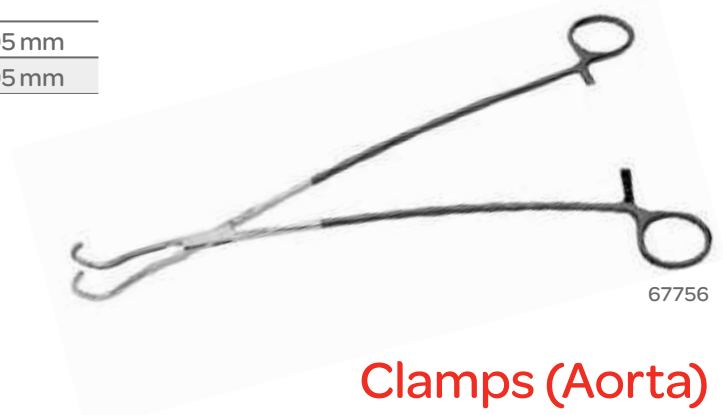

67756

Clamps (Aorta)

Ochsner Aorta Clamp

1x2 Vascular Teeth

CODE	JAW LENGTH	JAW DEPTH	LENGTH
37-1026	2 1/8 in 55 mm	3/4 in 18 mm	10 3/8 in 264 mm

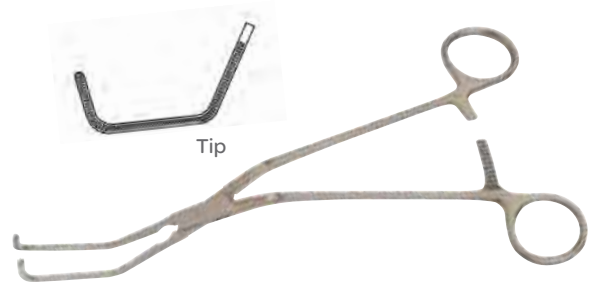

Clamps (Aortic Aneurysm)

DeBakey Aortic Aneurysm Clamp

1x2 Vascular Teeth

CODE	JAW LENGTH	LENGTH
37-1141	3 3/8 in	10 1/2 in 267 mm
37-1142	4 in	12 in 305 mm
37-1143	4 3/4 in	12 1/2 in 318 mm

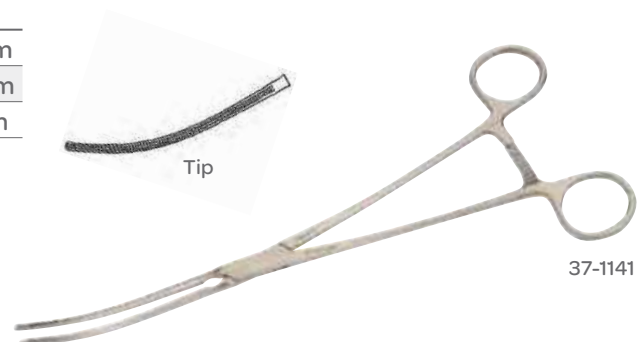

37-1141

Clamps (Bronchus)

Lees Bronchus Clamp

1 x 2 Vascular Teeth

CODE	JAW LENGTH	LENGTH
37-1035	1 $\frac{5}{8}$ in 41 mm	9 $\frac{1}{2}$ in 241 mm



Clamps (Coarctation)

Crafoord Coarctation Clamp

Curved Jaw

CODE	JAW LENGTH	LENGTH
19-8104	2 $\frac{1}{2}$ in 241 mm	9 $\frac{1}{2}$ in 241 mm
677521	4 x 67 mm	10 $\frac{1}{2}$ in 267 mm
677522	4 x 67 mm	12 in 305 mm



19-8104

Glover Opti-Length® Coarctation Clamp

CODE	DESCRIPTION	LENGTH
67-7525	Straight	10 in 254 mm
67-7526	Curved	10 in 254 mm



67-7526

Clamps (Hemostatic)

Gemini Hemostatic Clamp

CODE	DESCRIPTION	LENGTH
19-5582	Curved	9 in 229 mm
19-5583	Curved	10 in 279 mm



18-5582

Clamps (Iliac)

Cooley Opti-Length® Iliac Clamp

2 x 2 Vascular Teeth

CODE	DESCRIPTION	LENGTH
67-7533	Angled	12 in 305 mm

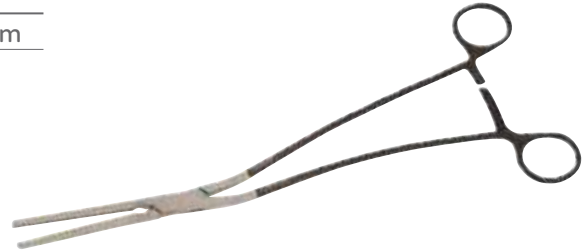

Clamps (Intestinal)

Dennis Intestinal Clamp

CODE	JAW LENGTH	LENGTH
19-4060	2 ¼ in 57 mm	9 ½ in 241 mm

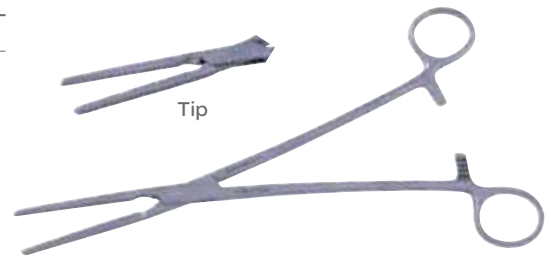

Glassman Gastrointestinal Clamp

3 mm Tip, Clamp Non Crushing

CODE	DESCRIPTION	LENGTH
67-7528	Straight	10 in 254 mm
67-7530	Straight	11 ¼ in 286 mm
67-7532	Straight	13 in 330 mm
67-7527	Angled	10 in 254 mm
67-7529	Angled	11 ¼ in 286 mm
67-7531	Angled	13 in 330 mm



Masters Intestinal Clamp

CODE	JAW LENGTH	LENGTH
19-4062	4 ½ in 114 mm	9 ¼ in 235 mm
19-4061	6 ½ in 165 mm	10 ¾ in 273 mm



19-4062

Clamps (Ligature Carrying)

Classic® Opti-Length® Ligature Carrying Clamp

CODE	LENGTH
67-7534	11 in 279 mm
67-7535	12 in 305 mm



67-7534

Clamps (Liver)

Masters-Schwartz Liver Clamp

CODE	JAW LENGTH	JAW WIDTH	LENGTH
19-4063	7½ in 191 mm	½ in 13 mm	12 in 305 mm



Clamps (Pelvic)

Masterson Pelvic Clamp

Jaw Length 1¾ in (45 mm), 2 x 3 Vascular Teeth

CODE	DESCRIPTION	LENGTH
37-1522	Straight	10½ in 267 mm
37-1523	Curved	10½ in 267 mm

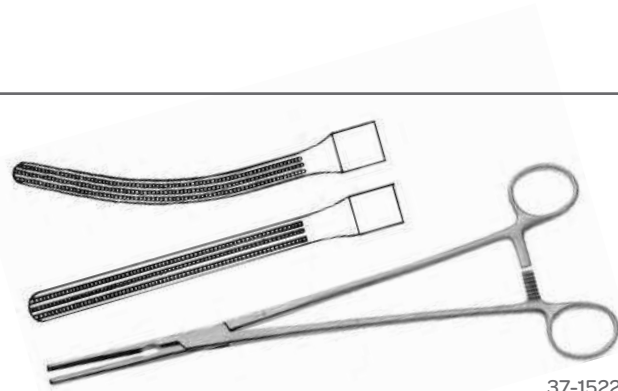

37-1522

Harrington-Mixer Clamp

Longitudinal Serrations with Cross-Serrated Tips

CODE	DESCRIPTION	LENGTH
30-8051	Right Angle	12¼ in 311 mm



Clamps (Thoracic)

Harrington Thoracic Clamp

CODE	DESCRIPTION	LENGTH
30-8049	Right Angled	12 in 305 mm

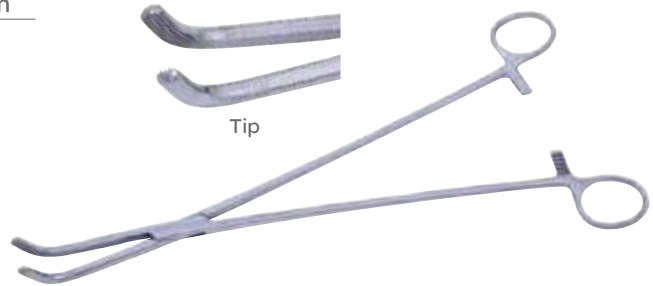

Jones Thoracic Clamp

CODE	DESCRIPTION	LENGTH
19-8152	Curved	11¼ in 286 mm



Mixer Thoracic Clamp

Angular

CODE	DESCRIPTION	LENGTH
19-8146	Longitudinal Serrations	11 in 279 mm
19-8147	Standard Jaw	11 in 279 mm



Modified Collier Thoracic Clamp

CODE	DESCRIPTION	LENGTH
30-8065	Curved	10½ in 267 mm



Clamps (Vascular)

DeBakey Classic® Vascular Clamp

CODE	LENGTH
67-7523	9 in 229 mm
67-7524	10 in 254 mm

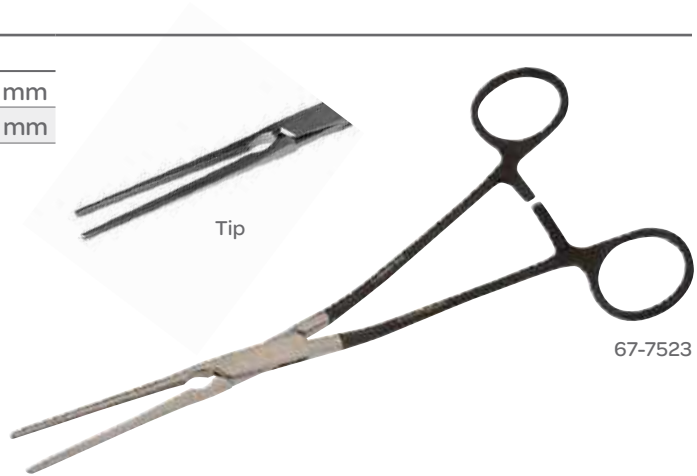

DeBakey Vascular Clamp

Acutely Curved

CODE	VASCULAR TEETH	JAW LENGTH	JAW DEPTH	LENGTH
37-1130	1x2	2 in	3/8 in	9 1/2 in 241 mm

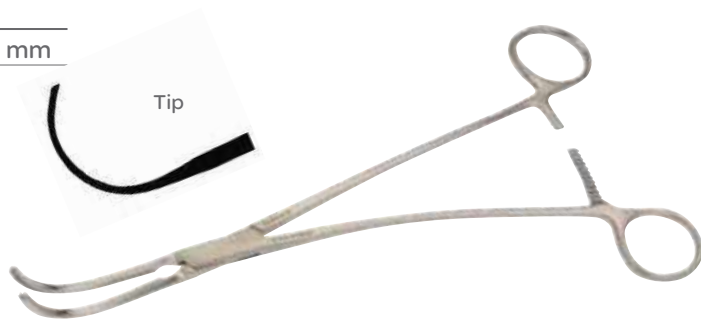

Containers (Sterilization Case)

Karlin™ PG Magnum Case

CODE	DESCRIPTION
46-3407	Storage/Sterilizing Case for 12 Magnum Handle Instruments



Containers (Sterilization Case)

Karlin™ XL Magnum Case

CODE	DESCRIPTION
46-3222	Storage/Sterilizing Case for 12 'XL Magnum' Instruments



OBESE PATIENT

Curettes

Cobb Curette

CODE	DESCRIPTION	TIP SIZE	LENGTH
23-2570	#000	3 mm	11 in 279 mm
23-2571	#00	4 mm	11 in 279 mm
23-2572	#0	5 mm	11 in 279 mm
23-2573	#1	6 mm	11 in 279 mm
23-2574	#2	8 mm	11 in 279 mm
23-2576	#4	12 mm	11 in 279 mm
23-2577	#5	13 mm	11 in 279 mm
23-2578	#6	15 mm	11 in 279 mm



Curettes

Cobb Spinal Curette

CODE	CUP	LENGTH
677104	2 x 3.3 mm	12 ½ in 318 mm
677107	2.5 x 4 mm	12 ½ in 318 mm
677109	3 x 5 mm	12 ½ in 318 mm
677111	3.5 x 6 mm	12 ½ in 318 mm
677113	4.5 x 7.5 mm	12 ½ in 318 mm
677115	5.5 x 9 mm	12 ½ in 318 mm
677117	7.5 x 11.5 mm	12 ½ in 318 mm
677119	8.5 x 13 mm	12 ½ in 318 mm
677121	10 x 15.5 mm	12 ½ in 318 mm
677106	2 x 3.3 mm	14 in 356 mm
677108	2.5 x 4 mm	14 in 356 mm
677110	3 x 5 mm	14 in 356 mm
677112	3.5 x 6 mm	14 in 356 mm
677114	4.5 x 7.5 mm	14 in 356 mm
677116	5.5 x 9 mm	14 in 356 mm
677118	7.5 x 11.5 mm	14 in 356 mm
677120	8.5 x 13 mm	14 in 356 mm
677122	10 x 15.5 mm	14 in 356 mm
677105	2 x 3.3 mm	15 in 381 mm



677104

Scoville Curette

4 x 10 mm Cup

CODE	DESCRIPTION	LENGTH
23-1000	Straight	10 in 254 mm
23-1002	Angular	10 in 254 mm
23-1001	Lateral	10 in 254 mm



23-1000

Curettes

Spinal Fusion Curette

Straight

CODE	DESCRIPTION	CUP	LENGTH
677186	#000	3.5x5 mm	13 in 330 mm
677187	#00	4x5.5 mm	13 in 330 mm
677188	#0	4.5x6.5 mm	13 in 330 mm
677189	#1	5x7.5 mm	13 in 330 mm
677190	#2	6x10 mm	13 in 330 mm
677191	#3	7x11 mm	13 in 330 mm
677192	#4	8.5x13 mm	13 in 330 mm
677193	#5	9.5x14.5 mm	13 in 330 mm
677194	#6	10.5x17 mm	13 in 330 mm



677194

Spinal Fusion Curette

Straight

CODE	DESCRIPTION	CUP	LENGTH
677209	#000	3.5x5 mm	15 in 381 mm
677211	#00	4.5x6.5 mm	15 in 381 mm
677212	#0	5x7.5 mm	15 in 381 mm
677221	#1	6x10 mm	15 in 381 mm
677213	#2	7x11 mm	15 in 381 mm
677214	#3	8.5x13 mm	15 in 381 mm
677215	#4	9.5x14.5 mm	15 in 381 mm
677216	#5	10.5x17 mm	15 in 381 mm



677211

Scoville Spinal Disc Curette

CODE	DESCRIPTION	CUP	LENGTH
67-7171	Straight	4x10 mm	12 in 305 mm
67-7172	Straight	4x10 mm	14 in 356 mm
67-7173	Straight	6x10 mm	15 in 381 mm
67-7177	Angular Cup	4 mm	12 in 305 mm
67-7178	Angular Cup	4 mm	14 in 356 mm
67-7179	Angular Cup	6 mm	15 in 381 mm
67-7174	Down Pushing	4 mm	12 in 305 mm
67-7175	Down Pushing	4 mm	14 in 356 mm
67-7176	Down Pushing	6 mm	15 in 381 mm



677171

Curettes

Karlin™ Lumbar Microdiscectomy Instruments

Offset, Black Handles, Tip Configuration Marked On Handle

CODE	DESCRIPTION	LENGTH
46-3120	Set of 24 instruments with 2 cases Includes:	
46-3121	Curette, Forward Straight, 0	9½ in 241 mm
46-3122	Curette, Forward Straight, 1	9½ in 241 mm
46-3123	Curette, Forward Straight, 2	9½ in 241 mm
46-3124	Curette, Forward Angle, 0	9½ in 241 mm
46-3125	Curette, Forward Angle, 1	9½ in 241 mm
46-3126	Curette, Forward Angle, 2	9½ in 241 mm
46-3127	Curette, Forward Down, 0	9½ in 241 mm
46-3128	Curette, Forward Down, 1	9½ in 241 mm
46-3129	Curette, Forward Down, 2	9½ in 241 mm
46-3130	Curette, Backward Straight, 0	9½ in 241 mm
46-3131	Curette, Backward Straight, 1	9½ in 241 mm
46-3132	Curette, Backward Straight, 2	9½ in 241 mm
46-3133	Curette, Backward Angle, 0	9½ in 241 mm
46-3134	Curette, Backward Angle, 1	9½ in 241 mm
46-3135	Curette, Backward Angle, 2	9½ in 241 mm
46-3136	Curette, Backward Down, 0	9½ in 241 mm
46-3137	Curette, Backward Down, 1	9½ in 241 mm
46-3138	Curette, Backward Down, 2	9½ in 241 mm
46-3139	Penfield Dissector #1	9½ in 241 mm
46-3140	Penfield Dissector #2	9½ in 241 mm
46-3142	Penfield Dissector #4	9½ in 241 mm
46-3141	Nerve Hook	9½ in 241 mm
46-3143	Bone Waxer	9½ in 241 mm
46-3144	Spine Probe	9½ in 241 mm
46-3144	Storage/Sterilizing Case for 12 instruments	

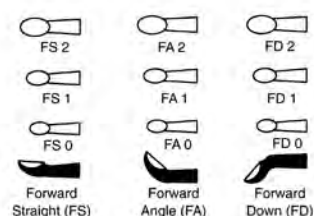
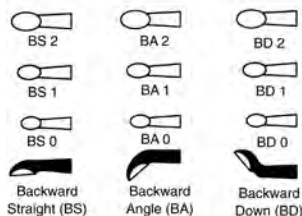

Curettes

Hardy™ Bayonet Curette

Offset, Black Handles, Tip Configuration Marked On Handle

CODE	DESCRIPTION	LENGTH
67-7139	2 mm Ring Angled Up	9½ in 241 mm
67-7140	2 mm Ring Angled Up	11 in 280 mm
67-7142	3 mm Ring Angled Up	11 in 280 mm
67-7144	5 mm Ring Angled Up	11 in 280 mm
67-7141	2 mm Ring Angled Up	13 in 330 mm
67-7143	3 mm Ring Angled Up	13 in 330 mm
67-7145	5 mm Ring Angled Up	13 in 330 mm
67-7147	2 mm Ring Angled Down	11 in 280 mm
67-7149	3 mm Ring Angled Down	11 in 280 mm
67-7151	5 mm Ring Angled Down	11 in 280 mm
67-7148	2 mm Ring Angled Down	13 in 330 mm
67-7150	3 mm Ring Angled Down	13 in 330 mm
67-7152	5 mm Ring Angled Down	13 in 330 mm
67-7153	2 mm Ring Angled 90° Left	9½ in 241 mm
67-7154	2 mm Ring Angled 90° Left	11 in 280 mm
67-7156	3 mm Ring Angled 90° Left	11 in 280 mm
67-7158	5 mm Ring Angled 90° Left	11 in 280 mm
67-7155	2 mm Ring Angled 90° Left	13 in 330 mm
67-7157	3 mm Ring Angled 90° Left	13 in 330 mm
67-7159	5 mm Ring Angled 90° Left	13 in 330 mm
67-7160	2 mm Ring Angled 45° Left	9½ in 241 mm
67-7161	2 mm Ring Angled 45° Left	11 in 280 mm
67-7163	3 mm Ring Angled 45° Left	11 in 280 mm
67-7165	5 mm Ring Angled 45° Left	11 in 280 mm
67-7162	2 mm Ring Angled 45° Left	13 in 330 mm
67-7164	3 mm Ring Angled 45° Left	13 in 330 mm
67-7166	5 mm Ring Angled 45° Left	13 in 330 mm
67-7167	5 mm Distal Tip Curved Right	11 in 280 mm
67-7168	5 mm Distal Tip Curved Right	13 in 330 mm
67-7169	5 mm Distal Tip Curved Left	11 in 280 mm
67-7170	5 mm Distal Tip Curved Left	13 in 330 mm



OBESE PATIENT

Curettes



46-3410

Karlin™ PG Magnum Cup Curette

Cup Curette, Forward

CODE	DESCRIPTION	WORKING DISTANCE	HANDLE DIAMETER	HANDLE LENGTH	TOTAL LENGTH
46-3410	46-3410 Karlin™ PG MAGNUM Cup Curettes Large capacity cup sizes permit rapid tissue removal Set of 12 Cup Curettes with Case includes:				
46-3411	Straight 7 mm	4 ⁷ / ₁₀ in 120 mm	1 ³ / ₂₅ in 30 mm	7 ⁴ / ₅ in 200 mm	12 ³ / ₅ in 320 mm
46-3412	Straight 9 mm	4 ⁷ / ₁₀ in 120 mm	1 ³ / ₂₅ in 30 mm	7 ⁴ / ₅ in 200 mm	12 ³ / ₅ in 320 mm
46-3413	Straight 11 mm	4 ⁷ / ₁₀ in 120 mm	1 ³ / ₂₅ in 30 mm	7 ⁴ / ₅ in 200 mm	12 ³ / ₅ in 320 mm
46-3414	Straight 13 mm	4 ⁷ / ₁₀ in 120 mm	1 ³ / ₂₅ in 30 mm	7 ⁴ / ₅ in 200 mm	12 ³ / ₅ in 320 mm
46-3415	Straight 15 mm	4 ⁷ / ₁₀ in 120 mm	1 ³ / ₂₅ in 30 mm	7 ⁴ / ₅ in 200 mm	12 ³ / ₅ in 320 mm
46-3416	Straight 17 mm	4 ⁷ / ₁₀ in 120 mm	1 ³ / ₂₅ in 30 mm	7 ⁴ / ₅ in 200 mm	12 ³ / ₅ in 320 mm
46-3417	Straight 19 mm	4 ⁷ / ₁₀ in 120 mm	1 ³ / ₂₅ in 30 mm	7 ⁴ / ₅ in 200 mm	12 ³ / ₅ in 320 mm
46-3418	Angle 7 mm	4 ⁷ / ₁₀ in 120 mm	1 ³ / ₂₅ in 30 mm	7 ⁴ / ₅ in 200 mm	12 ³ / ₅ in 320 mm
46-3419	Angle 9 mm	4 ⁷ / ₁₀ in 120 mm	1 ³ / ₂₅ in 30 mm	7 ⁴ / ₅ in 200 mm	12 ³ / ₅ in 320 mm
46-3420	Angle 11 mm	4 ⁷ / ₁₀ in 120 mm	1 ³ / ₂₅ in 30 mm	7 ⁴ / ₅ in 200 mm	12 ³ / ₅ in 320 mm
46-3421	Down Pushing 7 mm	4 ⁷ / ₁₀ in 120 mm	1 ³ / ₂₅ in 30 mm	7 ⁴ / ₅ in 200 mm	12 ³ / ₅ in 320 mm
46-3422	Down Pushing 9 mm	4 ⁷ / ₁₀ in 120 mm	1 ³ / ₂₅ in 30 mm	7 ⁴ / ₅ in 200 mm	12 ³ / ₅ in 320 mm

Curettes

Karlin™ Magnum PG Cup Curette

Forward Angle, PG Magnum Style Handle

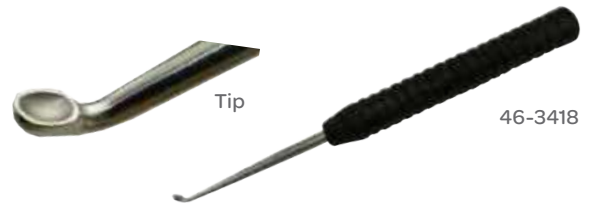

CODE	DESCRIPTION	WORKING DISTANCE	HANDLE DIAMETER	HANDLE LENGTH	TOTAL LENGTH
46-3418	PG 7 mm	4 ⁷ / ₁₀ in 120 mm	1 ³ / ₂₃ in 30 mm	7 ⁴ / ₅ in 200 mm	12 ³ / ₅ in 320 mm
46-3419	PG 9 mm	4 ⁷ / ₁₀ in 120 mm	1 ³ / ₂₃ in 30 mm	7 ⁴ / ₅ in 200 mm	12 ³ / ₅ in 320 mm
46-3420	PG 11 mm	4 ⁷ / ₁₀ in 120 mm	1 ³ / ₂₃ in 30 mm	7 ⁴ / ₅ in 200 mm	12 ³ / ₅ in 320 mm

Karlin™ Magnum PG Cup Curette

Forward Down Pushing, PG Magnum Style Handle



CODE	DESCRIPTION	WORKING DISTANCE	HANDLE DIAMETER	HANDLE LENGTH	TOTAL LENGTH
46-3421	PG 7 mm	4 ⁷ / ₁₀ in 120 mm	1 ³ / ₂₅ in 30 mm	7 ⁴ / ₅ in 200 mm	12 ³ / ₅ in 320 mm
46-3422	PG 9 mm	4 ⁷ / ₁₀ in 120 mm	1 ³ / ₂₅ in 30 mm	7 ⁴ / ₅ in 200 mm	12 ³ / ₅ in 320 mm

Karlin™ PG Magnum Cup Curette

Forward Straight, PG Magnum Style Handle



CODE	DESCRIPTION	WORKING DISTANCE	HANDLE DIAMETER	HANDLE LENGTH	TOTAL LENGTH
46-3411	PG 7 mm	4 ⁷ / ₁₀ in 120 mm	1 ³ / ₂₅ in 30 mm	7 ⁴ / ₅ in 200 mm	12 ³ / ₅ in 320 mm
46-3412	PG 9 mm	4 ⁷ / ₁₀ in 120 mm	1 ³ / ₂₅ in 30 mm	7 ⁴ / ₅ in 200 mm	12 ³ / ₅ in 320 mm
46-3413	PG 11 mm	4 ⁷ / ₁₀ in 120 mm	1 ³ / ₂₅ in 30 mm	7 ⁴ / ₅ in 200 mm	12 ³ / ₅ in 320 mm
46-3414	PG 13 mm	4 ⁷ / ₁₀ in 120 mm	1 ³ / ₂₅ in 30 mm	7 ⁴ / ₅ in 200 mm	12 ³ / ₅ in 320 mm
46-3415	PG 15 mm	4 ⁷ / ₁₀ in 120 mm	1 ³ / ₂₅ in 30 mm	7 ⁴ / ₅ in 200 mm	12 ³ / ₅ in 320 mm
46-3416	PG 17 mm	4 ⁷ / ₁₀ in 120 mm	1 ³ / ₂₅ in 30 mm	7 ⁴ / ₅ in 200 mm	12 ³ / ₅ in 320 mm
46-3417	PG 19 mm	4 ⁷ / ₁₀ in 120 mm	1 ³ / ₂₅ in 30 mm	7 ⁴ / ₅ in 200 mm	12 ³ / ₅ in 320 mm

Curettes

Spinal Disc Curette

Forward Angle, 30°

CODE	DESCRIPTION	LENGTH
677219	2.5 x 4 mm	11 in 280 mm
677218	3 x 5 mm	11 in 280 mm



677218

Karlin™ XL Magnum Cup Curette

Down Pushing, XL Magnum Style Handle

CODE	DESCRIPTION	LENGTH
46-3234	7 mm	13 ¼ in 337 mm
46-3235	9 mm	13 ¼ in 337 mm

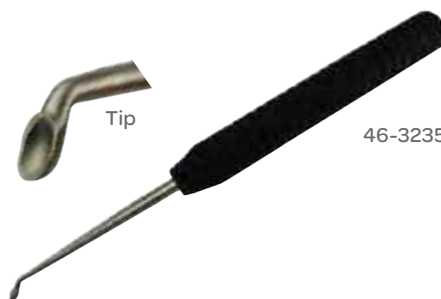

46-3235

Karlin™ XL Magnum Cup Curette

Extra Long Curettes, Black Handles, Lightweight, Set of 12

CODE		LENGTH	CUP
46-3225	Set Includes:	13 ¼ in	337 mm
46-3226	Forward Straight	13 ¼ in	7 mm
46-3227	Forward Straight	13 ¼ in	9 mm
46-3228	Forward Straight	13 ¼ in	11 mm
46-3229	Forward Straight	13 ¼ in	13 mm
46-3230	Forward Straight	13 ¼ in	15 mm
46-3236	Forward Straight	13 ¼ in	17 mm
46-3237	Forward Straight	13 ¼ in	19 mm
46-3231	Forward Angle	13 ¼ in	7 mm
46-3232	Forward Angle	13 ¼ in	9 mm
46-3233	Forward Angle	13 ¼ in	11 mm
46-3234	Down Pushing	13 ¼ in	7 mm
46-3235	Down Pushing	13 ¼ in	9 mm
46-3222	Storage/Sterilizing case for 12 XL Magnum instruments	13 ¼ in	



46-3325

Curettes



46-3400

Karlin™ PG Magnum Ring Curettes

Unique, broad-neck fulcrum provides atraumatic leverage on opposing vertebrae end plates. Dual-coned, precision sharpened rings facilitate rapid, efficient bone sculpting and removal. Each instrument engraved with depth indicator to minimize potential for deep penetration.

CODE		WORKING DISTANCE	HANDLE DIAMETER	HANDLE LENGTH	LENGTH
46-3400	Set of 6 Includes:				
46-3401	Ring Curette, Straight 6 mm	4 7/10 in 120 mm	1 3/25 in 30 mm	7 4/5 in 200 mm	12 3/5 in 320 mm
46-3402	Ring Curette, Straight 8 mm	4 7/10 in 120 mm	1 3/25 in 30 mm	7 4/5 in 200 mm	12 3/5 in 320 mm
46-3403	Ring Curette, Straight 10 mm	4 7/10 in 120 mm	1 3/25 in 30 mm	7 4/5 in 200 mm	12 3/5 in 320 mm
46-3404	Ring Curette, Angle 6 mm	4 7/10 in 120 mm	1 3/25 in 30 mm	7 4/5 in 200 mm	12 3/5 in 320 mm
46-3405	Ring Curette, Angle 8 mm	4 7/10 in 120 mm	1 3/25 in 30 mm	7 4/5 in 200 mm	12 3/5 in 320 mm
46-3406	Ring Curette, Angle 10 mm	4 7/10 in 120 mm	1 3/25 in 30 mm	7 4/5 in 200 mm	12 3/5 in 320 mm
46-3407	PG Magnum Sterilizing Case				

Karlin™ Magnum XL Magnum Cup Curette

Forward Straight, XL Magnum Style Handle

CODE	DESCRIPTION	LENGTH
46-3226	7 mm	13 1/4 in 337 mm
46-3227	9 mm	13 1/4 in 337 mm
46-3228	11 mm	13 1/4 in 337 mm
46-3229	13 mm	13 1/4 in 337 mm
46-3230	15 mm	13 1/4 in 337 mm
46-3236	17 mm	13 1/4 in 337 mm
46-3237	19 mm	13 1/4 in 337 mm



46-3227

Karlin™ XL Magnum Cup Curette

Forward Angle, XL Magnum Style Handle

CODE	DESCRIPTION	LENGTH
46-3231	7 mm	13 1/4 in 337 mm
46-3232	9 mm	13 1/4 in 337 mm
46-3233	11 mm	13 1/4 in 337 mm

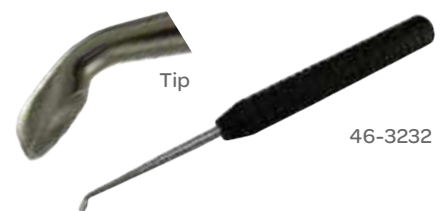

46-3232

Curettes



46-3401

Karlin™ PG Magnum Ring Curette

CODE	DESCRIPTION	WORKING DISTANCE	HANDLE DIAMETER	HANDLE LENGTH	TOTAL LENGTH
46-3401	Straight, PG 6 mm	4 ⁹ / ₁₀ in 120 mm	1 ³ / ₂₅ in 30 mm	7 ⁴ / ₅ in 200 mm	12 ³ / ₅ in 320 mm
46-3402	Straight, PG 8 mm	4 ⁹ / ₁₀ in 120 mm	1 ³ / ₂₅ in 30 mm	7 ⁴ / ₅ in 200 mm	12 ³ / ₅ in 320 mm
46-3403	Angle, PG 6 mm	4 ⁹ / ₁₀ in 120 mm	1 ³ / ₂₅ in 30 mm	7 ⁴ / ₅ in 200 mm	12 ³ / ₅ in 320 mm
46-3404	Angle, PG 6 mm	4 ⁹ / ₁₀ in 120 mm	1 ³ / ₂₅ in 30 mm	7 ⁴ / ₅ in 200 mm	12 ³ / ₅ in 320 mm
46-3405	Angle, PG 8 mm	4 ⁹ / ₁₀ in 120 mm	1 ³ / ₂₅ in 30 mm	7 ⁴ / ₅ in 200 mm	12 ³ / ₅ in 320 mm
46-3406	Angle, PG 10 mm	4 ⁹ / ₁₀ in 120 mm	1 ³ / ₂₅ in 30 mm	7 ⁴ / ₅ in 200 mm	12 ³ / ₅ in 320 mm

Karlin™ XL Magnum Ring Curette

Ring, XL Angled, XL Magnum Style Handle

CODE	DESCRIPTION	LENGTH
46-3219	6 mm	13 ¹ / ₄ in 337 mm
46-3220	8 mm	13 ¹ / ₄ in 337 mm
46-3221	10 mm	13 ¹ / ₄ in 337 mm



46-3220

Karlin™ XL Magnum Ring Curette

Ring, XL Straight, XL Magnum Style Handle

CODE	DESCRIPTION	LENGTH
46-3216	6 mm	13 ¹ / ₄ in 337 mm
46-3217	8 mm	13 ¹ / ₄ in 337 mm
46-3221	10 mm	13 ¹ / ₄ in 337 mm



46-3217

Karlin™ XL Magnum Ring Curette

Karlin™ XL Magnum Ring Curettes, Extra Long Curettes, Black Handles, Lightweight, Set of 6

CODE	DESCRIPTION	HANDLE LENGTH	HANDLE DIAMETER	LENGTH
46-3215	Set of six with case Includes:			
46-3216	Straight, 6 mm	13 ¹ / ₄ in 210 mm	1 ¹ / ₄ in 320 mm	13 ¹ / ₄ in 337 mm
46-3217	Straight, 8 mm	13 ¹ / ₄ in 210 mm	1 ¹ / ₄ in 320 mm	13 ¹ / ₄ in 337 mm
46-3218	Straight, 10 mm	13 ¹ / ₄ in 210 mm	1 ¹ / ₄ in 320 mm	13 ¹ / ₄ in 337 mm
46-3219	Angled, 6 mm	13 ¹ / ₄ in 210 mm	1 ¹ / ₄ in 320 mm	13 ¹ / ₄ in 337 mm
46-3220	Angled, 8 mm	13 ¹ / ₄ in 210 mm	1 ¹ / ₄ in 320 mm	13 ¹ / ₄ in 337 mm
46-3221	Angled, 10 mm	13 ¹ / ₄ in 210 mm	1 ¹ / ₄ in 320 mm	13 ¹ / ₄ in 337 mm
46-3222	Storage/Sterilizing Case for 12			



46-3215

Curettes

Spinal Curette

Straight

CODE	DESCRIPTION	LENGTH
23-1081	# 000	11 in 279 mm
23-1082	# 00	11 in 279 mm
23-1083	# 0	11 in 279 mm
23-1084	# 1	11 in 279 mm
23-1085	# 2	11 in 279 mm
23-1086	# 3	11 in 279 mm
23-1087	# 4	11 in 279 mm
23-1088	# 5	11 in 279 mm
23-1089	# 6	11 in 279 mm



OBESE PATIENT

Spinal Curette

Malleable Shaft

CODE	SHAFT	LENGTH
677390	1 mm	9 ½ in 241 mm
677391	1.5 mm	9 ½ in 241 mm
677392	2 mm	9 ½ in 241 mm
677393	2.5 mm	9 ½ in 241 mm
677394	3 mm	9 ½ in 241 mm
677395	3.5 mm	9 ½ in 241 mm
677396	4 mm	9 ½ in 241 mm
677397	4.5 mm	9 ½ in 241 mm
677398	5 mm	9 ½ in 241 mm

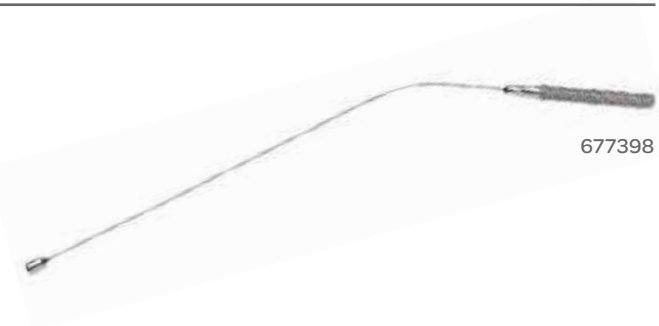

Dissectors

Penfield Dissector

Slightly Curved Blunt Dissector, Double-Ended

CODE	TIP	LENGTH
65-1019	#5	11 ½ in 272 mm



Dissectors

Garrett Vascular Dissector

Slightly Curved Blunt Dissector, Double-Ended

CODE	TIP	LENGTH
677410	#1	12½ in 318 mm
677412	#2	12½ in 318 mm
677414	#3	12½ in 318 mm
677416	#4	12½ in 318 mm
677418	#5	12½ in 318 mm
677411	#1	13½ in 343 mm
677413	#2	13½ in 343 mm
677415	#3	13½ in 343 mm
677417	#4	13½ in 343 mm
677419	#5	13½ in 343 mm



Elevators

Cushing Elevator

CODE	TIP	LENGTH
677034	Sharp Rounded Edge	9½ in 241 mm
677035	Sharp Rounded Edge	10½ in 266 mm
677036	Sharp Square Edge	9½ in 241 mm
677037	Sharp Square Edge	10½ in 266 mm



Cobb Elevator

CODE	WIDTH	LENGTH
26-5023	½ in	14 in 355 mm
26-5020	⅝ in	14 in 355 mm
26-5021	¾ in	14 in 355 mm
26-5022	1 in	14 in 355 mm



Cobb Elevator

CODE	SHARP ROUNDED EDGE	LENGTH
677028	⅜ in	12 in
677030	½ in	12 in
677032	¾ in	12 in
677029	⅜ in	13 in
677031	½ in	13 in
677033	¾ in	13 in



Elevators



46-3425

Karlin™ PG Magnum Cobb Elevator

CODE	TIP	HANDLE LENGTH	HANDLE DIAMETER	WORKING DISTANCE	LENGTH
46-3425	Set of 6 COBB Elevators with Case includes:				
46-3426	Straight 10 mm	4 ⁹ / ₁₀ in 200 mm	1 ³ / ₂₅ in 200 mm	4 ⁷ / ₁₀ in 120 mm	12 ³ / ₅ in 320 mm
46-3427	Straight 15 mm	4 ⁹ / ₁₀ in 200 mm	1 ³ / ₂₅ in 200 mm	4 ⁷ / ₁₀ in 120 mm	12 ³ / ₅ in 320 mm
46-3428	Straight 20 mm	4 ⁹ / ₁₀ in 200 mm	1 ³ / ₂₅ in 200 mm	4 ⁷ / ₁₀ in 120 mm	12 ³ / ₅ in 320 mm
46-3429	Straight 25 mm	4 ⁹ / ₁₀ in 200 mm	1 ³ / ₂₅ in 200 mm	4 ⁷ / ₁₀ in 120 mm	12 ³ / ₅ in 320 mm
46-3430	Straight 30 mm	4 ⁹ / ₁₀ in 200 mm	1 ³ / ₂₅ in 200 mm	4 ⁷ / ₁₀ in 120 mm	12 ³ / ₅ in 320 mm
46-3431	Straight 35 mm	4 ⁹ / ₁₀ in 200 mm	1 ³ / ₂₅ in 200 mm	4 ⁷ / ₁₀ in 120 mm	12 ³ / ₅ in 320 mm
46-3432	Sterilizing Case for any 12 PG MAGNUM Instruments				



46-3240

Karlin™ XL MAGNUM Cobb Elevators Extra Length (XL)

Black Handles, Allow Two-Handed Control. Sharp, Broad Instruments Designed To Facilitate Soft Tissue Elevation And Removal

CODE	TIP	HANDLE DIAMETER	LENGTH
46-3240	Set of 6 in case for twelve instruments includes:		
46-3241	10 mm	1 ¹ / ₄ in 32 mm	12 ³ / ₅ in 320 mm
46-3242	15 mm	1 ¹ / ₄ in 32 mm	12 ³ / ₅ in 320 mm
46-3243	20 mm	1 ¹ / ₄ in 32 mm	12 ³ / ₅ in 320 mm
46-3244	25 mm	1 ¹ / ₄ in 32 mm	12 ³ / ₅ in 320 mm
46-3245	30 mm	1 ¹ / ₄ in 32 mm	12 ³ / ₅ in 320 mm
46-3246	35 mm	1 ¹ / ₄ in 32 mm	12 ³ / ₅ in 320 mm
46-3222	Sterilizing Case for any 12 PG Magnum Instruments		

Elevators



Karlin™ PG Magnum Cobb Elevator

Straight, with PG Magnum Handle

CODE	DESCRIPTION	WORKING DISTANCE	HANDLE DIAMETER	HANDLE LENGTH	TOTAL LENGTH
46-3406	10 mm	4 ⁷ / ₁₀ in 120 mm	1 ³ / ₂₅ in 30 mm	7 ⁴ / ₅ in 200 mm	12 ³ / ₅ in 320 mm
46-3401	15 mm	4 ⁷ / ₁₀ in 120 mm	1 ³ / ₂₅ in 30 mm	7 ⁴ / ₅ in 200 mm	12 ³ / ₅ in 320 mm
46-3403	20 mm	4 ⁷ / ₁₀ in 120 mm	1 ³ / ₂₅ in 30 mm	7 ⁴ / ₅ in 200 mm	12 ³ / ₅ in 320 mm
46-3404	25 mm	4 ⁷ / ₁₀ in 120 mm	1 ³ / ₂₅ in 30 mm	7 ⁴ / ₅ in 200 mm	12 ³ / ₅ in 320 mm
46-3402	30 mm	4 ⁷ / ₁₀ in 120 mm	1 ³ / ₂₅ in 30 mm	7 ⁴ / ₅ in 200 mm	12 ³ / ₅ in 320 mm
46-3405	35 mm	4 ⁷ / ₁₀ in 120 mm	1 ³ / ₂₅ in 30 mm	7 ⁴ / ₅ in 200 mm	12 ³ / ₅ in 320 mm

Karlin™ XL Magnum Cobb Elevator

With XL Magnum Handle

CODE	DESCRIPTION	LENGTH
46-3241	10 mm	13 ¹ / ₄ in 337 mm
46-3242	15 mm	13 ¹ / ₄ in 337 mm
46-3243	20 mm	13 ¹ / ₄ in 337 mm
46-3244	25 mm	13 ¹ / ₄ in 337 mm
46-3245	30 mm	13 ¹ / ₄ in 337 mm
46-3246	35 mm	13 ¹ / ₄ in 337 mm



Woodson Elevator

CODE	DESCRIPTION	LENGTH
67-7039	3 mm and 4 mm Spatula 3 x 10 mm and 4 x 12 mm	12 in 305 mm
67-7038	3 mm and 4 mm Spatula 3 x 10 mm and 4 x 12 mm	12 in 305 mm



Forceps (General)

Schmidt Forceps

CODE	DESCRIPTION	LENGTH
17-2157	Closed Ring	10 in 254 mm

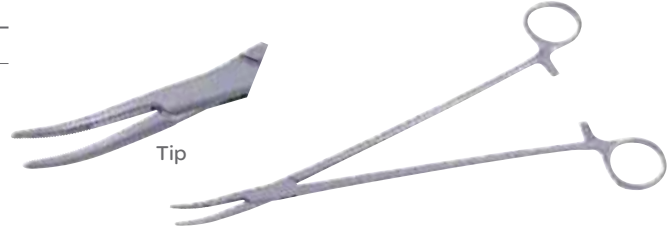

Forceps (Tissue)

Tissue Forceps

Right Angled

CODE	LENGTH
32-3551	12¼ in 311 mm
32-3552	14 in 355 mm



Forceps (Dressing)

Thumb Forceps

CODE	JAWS	LENGTH
32-3541	3.4 mm	14 in 356 mm



Forceps (Bone Cutting)

Horsley Bone Cutting Forceps

Double-Action, Curved Shaft

CODE	JAW	LENGTH
30-1298	Angular	10½ in 267 mm

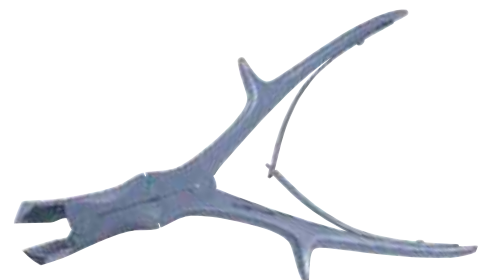

Forceps (Bone Cutting)

Stille-Liston Bone Forceps

Double-Action

CODE	DESCRIPTION	LENGTH
30-1295	Straight	10 ½ in 267 mm
30-1296	Curved	10 ½ in 267 mm



30-1295

Forceps (Intestine)

Bridge Deep Surgical Forceps

CODE	DESCRIPTION	LENGTH
30-4700	Curved	11 in 279 mm

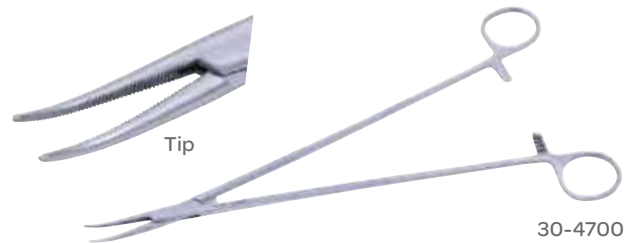

30-4700

Forceps (Dressing)

Dressing Forceps

CODE	DESCRIPTION	TIP WIDTH	LENGTH
91-5422	Insulated		10 in 250 mm
30-4138	Serrated	3 mm	10 in 254 mm
30-4139	Serrated	3.4 mm	12 in 305 mm



30-4138

Dressing Forceps

Standard Pattern, Fine Serrated Handle

CODE	LENGTH
06-0025	10 in 254 mm
06-0030	12 in 305 mm
06-0035	14 in 350 mm
06-0040	16 in 405 mm
06-0045	18 in 455 mm

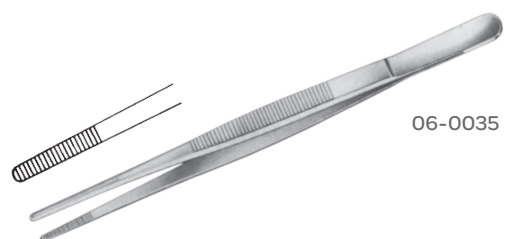

06-0035

Forceps (Dressing)

Dressing Forceps

Non-Magnetic, Titanium, Serrated, for Interventional MRI

CODE	TIP WIDTH	LENGTH
65-2407	3 mm	10 in 254 mm



Potts-Smith Dressing Forceps

CODE	DESCRIPTION	LENGTH
30-8022	Serrated	9 3/4 in 248 mm
30-8122	Serrated	12 in 305 mm
06-4638	Serrated	14 in 350 mm

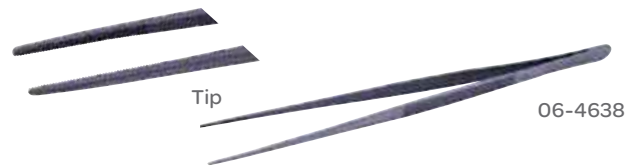

Forceps

General Surgery Opti-Length® Forceps

CODE	TIP WIDTH	LENGTH
67-7584	2 mm	10 in 254 mm
67-7585	3 mm	10 in 254 mm
67-7586	2 mm	12 in 305 mm
67-7587	2 mm	12 in 305 mm



Classic Plus® Opti-Length® Forceps

Fine Tungsten Carbide Inserts

CODE	TIP WIDTH	LENGTH
677582	2 mm	8 in 203 mm
677583	3 mm	8 in 203 mm
677584	2 mm	10 in 254 mm
677585	2 mm	10 in 254 mm
677587	2 mm	12 in 305 mm
677586	3 mm	12 in 305 mm



Meeker Forceps

CODE	TIP WIDTH	LENGTH
30-4701	Right Angle, 10 mm	14 in 356 mm

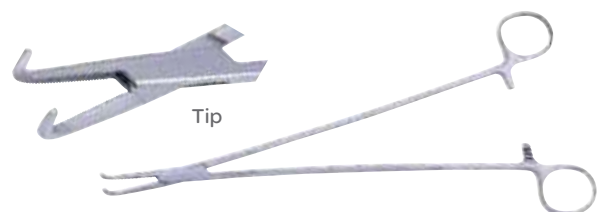

Forceps (Dressing)

Single Tuttle Intestinal Forceps

CODE	TIP	LENGTH
67-7601	Fenestrated 8 mm	12 in 305 mm



Forceps (Hemostatic)

Gemini Forceps

CODE	TIP	LENGTH
54-7266	Right Angle	16 in 405 mm



Gemini Hemostatic Forceps

Delicate 80° Curve

CODE	TIP	LENGTH
677615	1.5 mm	14 in 356 mm



Meeker Intestinal Forceps

CODE	TIP	LENGTH
677568	10 mm Right Angle	14 in 356 mm



Forceps (Dressing)

Rochester-Carmalt Hemostatic Forceps

Curved

CODE	TIP	LENGTH
30-8092	Longitudinal Serrations	12¼ in 312 mm



Rochester-Pean Hemostatic Forceps

CODE	TIP	LENGTH
32-3553	Curved	12 in 305 mm
32-3554	Curved	14 in 355 mm



32-3553

Rochester-Pean Thoracic Forceps

Cross-Serrations

CODE	DESCRIPTION	LENGTH
30-8093	Curved	12 in 305 mm

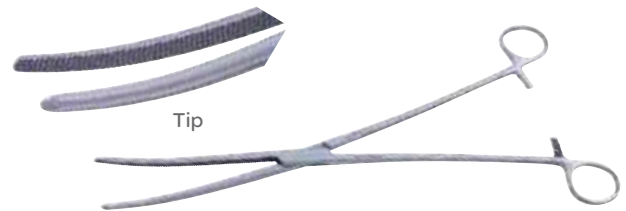

Tip

Rochester-Ochsner Forceps

1x2 Teeth

CODE	TIP	LENGTH
30-8090	Straight	10 in 254 mm
32-3539	Straight	14 in 354 mm
30-8091	Curved	10 in 254 mm
30-8093	Curved	12 in 305 mm



32-3539

Schmidt Hemostatic Forceps Curved

CODE	TIP	LENGTH
677612	Curved 2 mm	12¼ in 312 mm

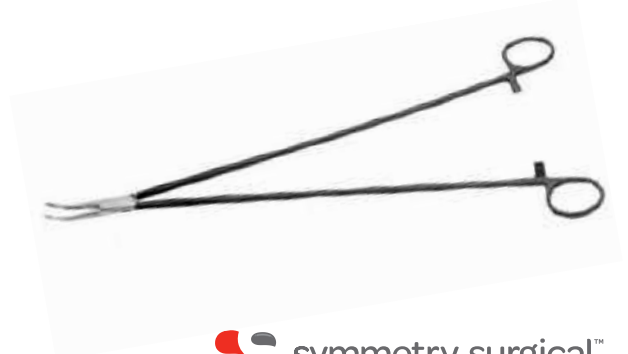

Forceps (Hysterectomy)

Hysterectomy Forceps

CODE	DESCRIPTION	LENGTH
67-7605	44 mm Straight, 1 x 2 Single Tooth Jaw, Off-Set Shank	12 in 305 mm
67-7602	Heavy Jaws, Double Tooth	12 in 305 mm



Kocher Intestinal Forceps

CODE	DESCRIPTION	LENGTH
30-4300	Straight, Longitudinal Serrations	11 in 279 mm



Forceps (Ligature Carrying)

DeBakey-Semb Ligature Carrying Forceps

CODE	TEETH	LENGTH OF SERRATIONS	JAW LENGTH	LENGTH
37-1132	1x2 Vascular	5/8 in 15 mm	2 1/4 in 57 mm	10 in 254 mm



Semb Ligature Carrying Forceps

CODE	DESCRIPTION	LENGTH
30-8056	Acute Curve	9 1/2 in 241 mm



Forceps (Lung & Tissue)

Duval Lung & Tissue Forceps

CODE	DESCRIPTION	LENGTH
17-3671	25 mm	12 in 305 mm

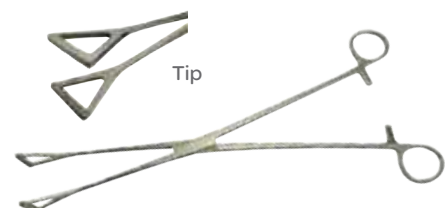

Forceps (Thoracic)

Thoarcic Clamp

CODE		LENGTH
677563	Curved, Cross Serrations	12 in 305 mm
677611	Curved, Cross Serrations	14 in 356 mm
17-0840		16 in 405 mm
17-0845		18 in 455 mm



Bariatric Sponge Forceps

CODE	DESCRIPTION	LENGTH
32-3540	Serrated Jaw, Straight	14 in 355 mm



Thoracic Forceps

Crossed Serrations

CODE	DESCRIPTION	LENGTH
671000	Straight	12 in 305 mm
671001	Straight	14 in 356 mm
30-4573	Curved	10 in 254 mm
677565	Curved	12 in 305 mm
677566	Curved	14 in 356 mm



Thoracic Forceps

CODE	DESCRIPTION	LENGTH
30-8082	Curved, Delicate	9 ½ in 241 mm



Forceps (Tissue)

Allis Tissue Forceps

Standard Pattern

CODE	DESCRIPTION	LENGTH
50-0224	5 x 6 Teeth	9¾ in 245 mm
50-0245		18 in 455 mm

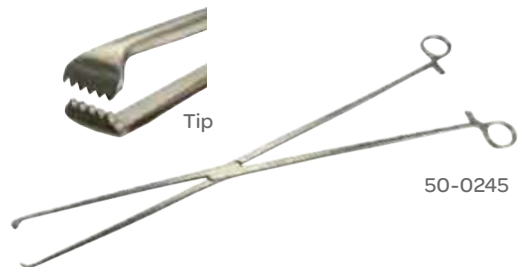

Babcock Tissue Forceps

Straight, Serrated

CODE	DESCRIPTION	LENGTH
32-3544		12 in 305 mm
32-3545		14 in 355 mm
67-7608	Fenestrated Tip, 9.5 mm	14 in 356 mm



Babcock Classic® Tissue Forceps

CODE	DESCRIPTION	LENGTH
32-7030	Standard Line	9½ in 242 mm

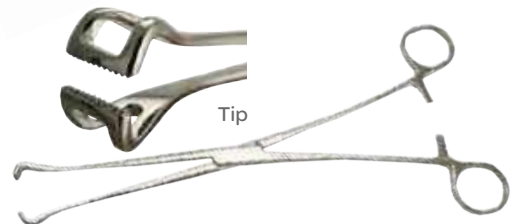

Babcock Tissue Forceps

Standard Pattern

CODE	LENGTH
50-1024	12 in 305 mm
50-1040	16 in 405 mm
50-1045	18 in 455 mm

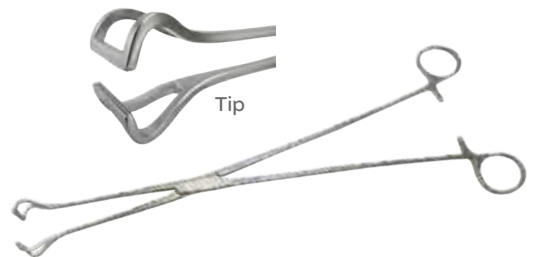

Tissue Forceps

CODE	DESCRIPTION	LENGTH
32-3542	1 x 2 Teeth	14 in 356 mm

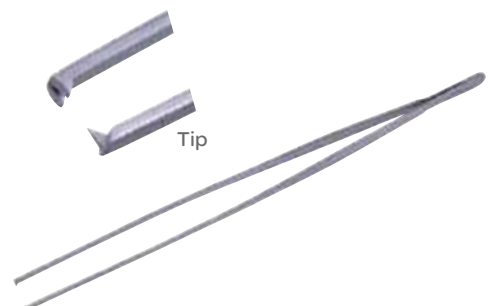

Forceps (Tissue)

Brown Tissue Forceps

Parallel Multi Teeth, Bonney Handle

CODE	DESCRIPTION	LENGTH
67-7579	3.4 mm	12 in 305 mm
67-7580	3.4 mm	14 in 355 mm
67-7581	3.4 mm	16 in 405 mm



67-7579

DeBakey Thoracic Tissue Forceps

CODE	LENGTH
32-3550	14 in 356 mm

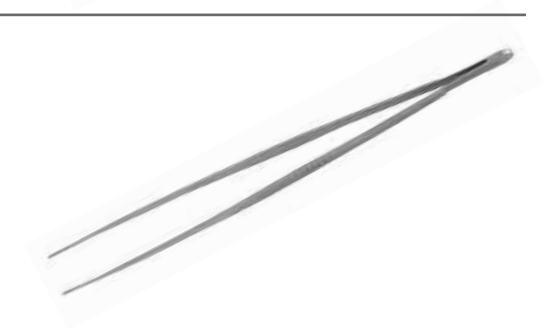

DeBakey Tissue Forceps

CODE	DESCRIPTION	LENGTH
37-1002		9½ in 241 mm
37-1003		12 in 305 mm
67-7800	Vascular Teeth, 1.5 mm, 1 x 2, Serrated Handle	12 in 305 mm
67-7801	Vascular Teeth, 2.0 mm, 1 x 2, Serrated Handle	12 in 305 mm
67-7802	Vascular Teeth, 1.5 mm, 1 x 2, Serrated Handle	14 in 355 mm
67-7803	Vascular Teeth, 2.0 mm, 1 x 2, Serrated Handle	14 in 355 mm



67-7801

DeBakey-Collier Tissue Forceps

CODE	DESCRIPTION	LENGTH
32-3549	Angled, Serrated	14 in 355 mm

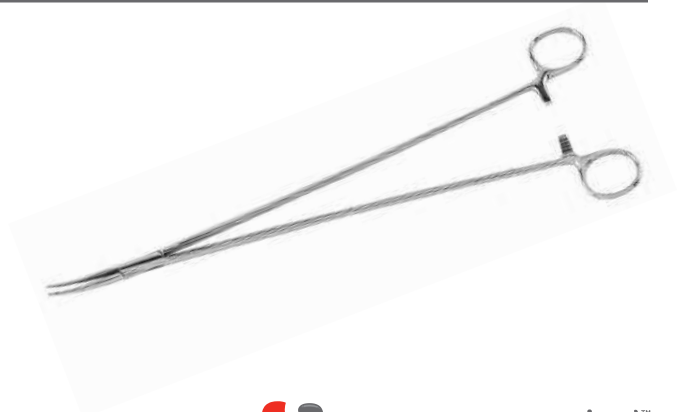

Forceps (Tissue)

Gemini Tissue Forceps

CODE	DESCRIPTION	LENGTH
32-3546	Serrated Tip	14 in 355 mm



Gerald Tissue Forceps

CODE	DESCRIPTION	LENGTH
32-3532	Fine Tungsten Carbide Inserts	10 in 254 mm
55-9006	Serrated	14 in 355 mm



32-3532

Opti-Length® Forceps

General Surgery

CODE	TIP WIDTH	LENGTH
67-7587	3 mm	12 in 305 mm



Tip

Potts-Smith Tissue Forceps

CODE	TEETH	TIP WIDTH	LENGTH
06-4835	1x2		12 in 305 mm
30-8123		1.8 mm	12 in 305 mm

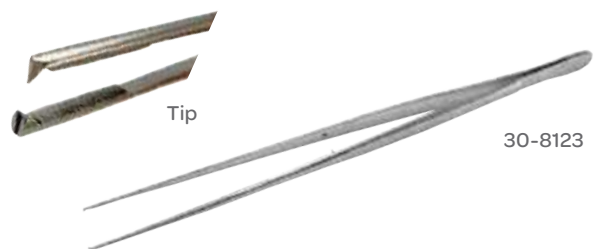

Tip

30-8123

Russian Tissue Forceps

CODE	LENGTH
32-3543	14 in 355 mm

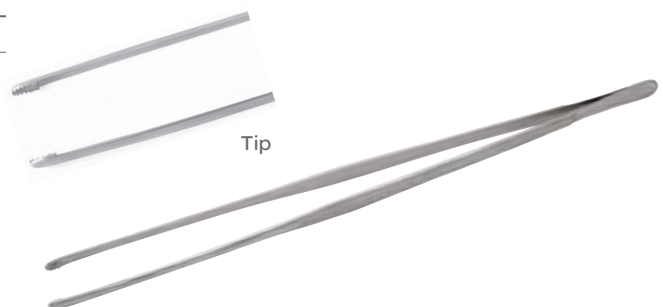

Tip

Forceps (Tissue)

Russian Tissue Forceps

CODE	DESCRIPTION	LENGTH
67-7606	Cup Tip, 7.2 mm	11 in 280 mm
67-7607	Cup Tip, 7.2 mm	12 in 305 mm



Russian Tissue Forceps

CODE	LENGTH
07-1530	14 in 355 mm

Tissue Forceps

1x2 Teeth

CODE	TIP	LENGTH
32-3557	Non-Slip, Round	10 in 254 mm
06-0525	Standard Pattern	10 in 250 mm
06-0530	Standard Pattern	12 in 305 mm
06-0535	Standard Pattern	14 in 355 mm
06-0545	Standard Pattern	18 in 455 mm
30-4156	Width 3.1 mm	10 in 254 mm
30-4157	Width 3.9 mm	12 in 305 mm



Tuttle (Singley) Tissue Forceps

CODE	LENGTH
07-1727-H	12 in 305 mm
07-1724	14 in 355 mm
07-1728	18 in 455 mm



Willauer-Allis Tissue Forceps

CODE	DESCRIPTION	LENGTH
30-8085	Curved	10 in 254 mm
32-3547	3x3 Teeth	14 in 355 mm
67-7614	5x6 Teeth, 8 mm	14 in 355 mm

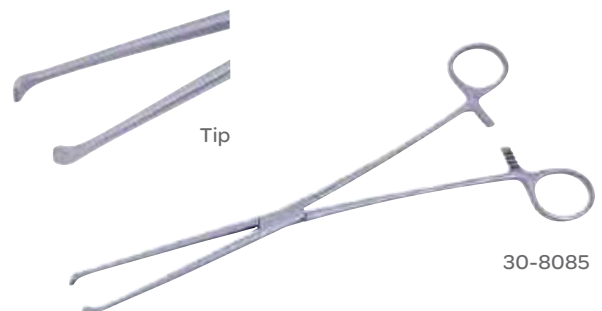

Forceps (Tissue)

Babcock Forceps

CODE	LENGTH
50-1024-H	12 in 305 mm



Forceps (Vascular)

DeBakey Vascular Forceps

Lighter Model

CODE	DESCRIPTION	LENGTH
37-1012		9½ in 241 mm
37-1013		12 in 305 mm
67-7609	Classic®, 1x2 Teeth	14 in 355 mm

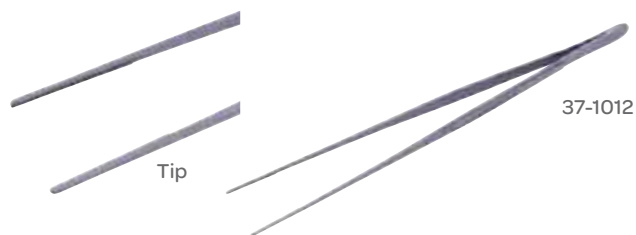

DeBakey-Diethrich Vascular Forceps

CODE	DESCRIPTION	LENGTH
30-8133	Lighter Model	9½ in 241 mm



Gouges (Bone)

Bone Gouge

Straight

CODE	TIP	LENGTH
32-2000	6 mm Wide	11 in 279 mm



Hooks (Bone)

Bone Hook

Heavy-Duty

CODE	DESCRIPTION	LENGTH
32-3423	Sharp, 19 mm	9 in 229 mm
32-3424	Blunt, 19 mm	9 in 229 mm



Hooks (Nerve)

Adson Dissecting Hook

Roughened Handle

CODE	DESCRIPTION	LENGTH
67-7428	5 mm, Sharp	10 in 254 mm
67-7429	5 mm, Blunt	10 in 254 mm



Cushing Gasserian Ganglion Hook

CODE	DESCRIPTION	LENGTH
67-7430	Right Angle Tip, Blunt, 5 mm	11 in 280 mm



Dandy Nerve Hook

CODE	DESCRIPTION	LENGTH
67-7431	Right Angle Tip, Blunt 3 mm	10 in 254 mm



Hoehn Nerve Hook

CODE	DESCRIPTION	LENGTH
67-7432	Right Angle Tip, Blunt, 7 mm	10 in 254 mm



Trachea Hook

CODE	DESCRIPTION	LENGTH
67-7440	Sharp, 5 mm	12 in 305 mm



Hooks (Nerve)

Karlin™ Lumbar Nerve Hook

CODE	DESCRIPTION	LENGTH
46-3141		9½ in 241 mm



Verity™ Nerve Hook

Titanium, Right Angle

CODE	DESCRIPTION	LENGTH
67-7433	Ball Tip, 3 mm	10 in 254 mm
67-7434	Blunt Tip, 2 mm	10 in 254 mm
67-7435	Blunt Tip, 3 mm	10 in 254 mm



67-7433

Rhoton® Nerve Hook

Titanium

CODE	DESCRIPTION	ANGLE	LENGTH
67-7436	#9, Semi-Sharp, 1 mm	90°	10 in 254 mm
67-7437	#10, Blunt, 1 mm	90°	10 in 254 mm
67-7438	#11, Semi-Sharp, 3 mm	40°	10 in 254 mm



67-7436

Smithwick Nerve Hook And Dissector

Double-Ended-Blunt

CODE	HOOK LENGTH	LENGTH
38-1088	⅞ in 11 mm	12 in 305 mm

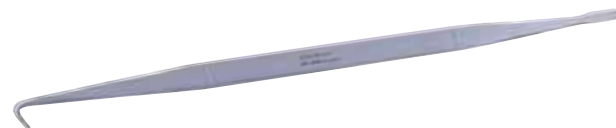

Knife Handles

Knife Handle

CODE	DESCRIPTION	LENGTH
01-2746	#3	16 in 406 mm

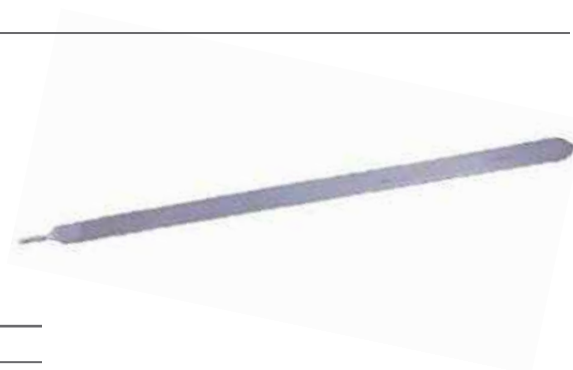

Laparoscopic

Laparoscopic

Symmetry Surgical has a broad portfolio of laparoscopic instruments designed specifically for large or obese patients. Our extended-length laparoscopic instruments are 45 cm long, giving surgeons additional reach to aid in completion of procedures.

Visit the laparoscopic section in this catalog to see our standard as well as extended-length laparoscopic instruments.



Laparoscopic (Bookwalter®)

Bookwalter®

CODE	DESCRIPTION
50-4685	Bookwalter® Telescopic Instrument Holder



Bookwalter® Universal Flex Arm System

CODE	DESCRIPTION
504805	Bookwalter® Universal Flex Arm System Kit Includes 1 each of 504805, 504806, 504807, 504808, 504809
504806	Ring Adapter for Bookwalter® Flex Arm
504807	Lap Instrument Adapter (Spring) for Bookwalter® Flex Arm
504808	Camera Lens Adapter for Bookwalter® Flex Arm
504809	Camera Housing Adapter for Bookwalter® Flex Arm

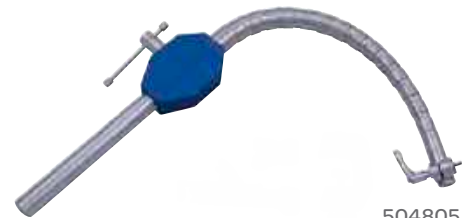

504805

Hasson "S" Retractor

CODE	DESCRIPTION	DIMENSIONS	
90-6003	2 ¼ in	6 in	152 mm
90-6004	Set of 2	6 ¼ in	160 mm
90-6002	Set of 2, 10 mm Wide		
90-6006			
90-6007		10 in	254 mm
90-6008		10 in	254 mm



90-6002

Needle Holders

Crile Wood Needle Holder

CODE	DESCRIPTION	LENGTH
32-310	Straight Serrated Jaw	11 $\frac{3}{4}$ in 300 mm
36-2004	Fine Tungsten Carbide Jaw Inserts	10 in 254 mm
36-2005	Fine Tungsten Carbide Jaw Inserts	12 in 305 mm



Tip



32-310

DeBakey Needle Holder

Fine Tungsten Carbide Inserts,

CODE	DESCRIPTION	TIP	LENGTH
32-040	Use with 3-0 And 4-0 Suture	2 mm	12 $\frac{1}{4}$ in



Tip

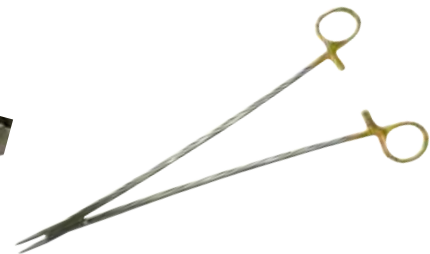

Heaney Needle Holder

Curved

CODE	DESCRIPTION	LENGTH
32-236	Fine Tungsten Carbide Inserts	12 in 305 mm
32-3687	Serrated	14 in 365 mm



32-3687

Masson Needle Holder

Fine Tungsten Carbide Inserts

CODE	DESCRIPTION	LENGTH
32-304		16 in 405 mm
32-305	Single-Action	18 in 455 mm



Tip

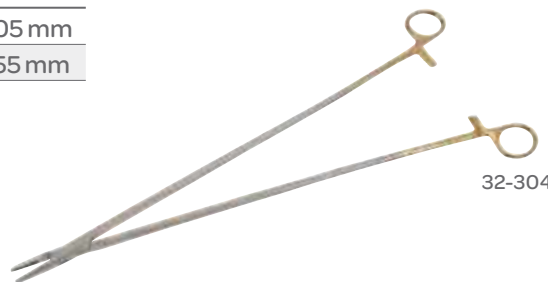

32-304

Needle Holders

Mayo-Hegar Needle Holder

Jaws Have Fine Tungsten Carbide Inserts

CODE	DESCRIPTION	LENGTH	
36-2019		10 in	254 mm
32-300	Use With 1-0, 2-0 Suture	11 7/8 in	301 mm
10-1828		14 in	355 mm
67-7624	2 mm	14 in	355 mm
67-7623	4 mm	14 in	355 mm

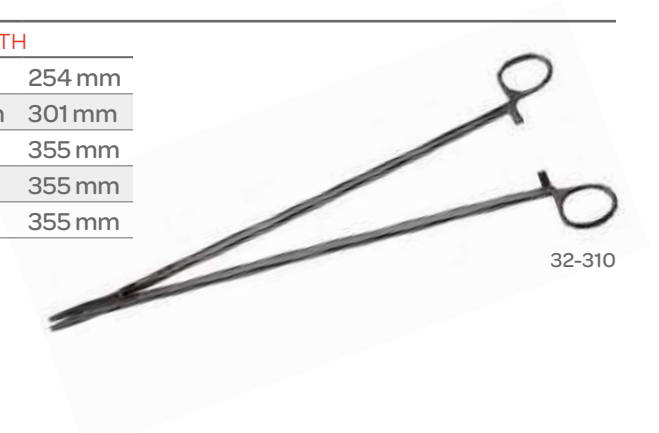

32-310

Needle Holder

Fine Tungsten Carbide Inserts

CODE	DESCRIPTION	LENGTH	
90-3038L	Curved 5 mm	17 3/4 in	450 mm

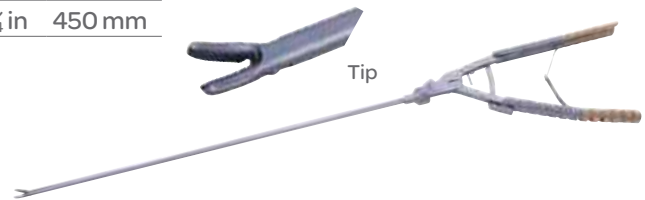

Ryder Classic Plus® Needle Holder

Fine Tungsten Carbide Inserts

CODE	DESCRIPTION	TIP	LENGTH	
36-3005	Serrated Jaw 2 mm	1.5 mm	10 in	254 mm

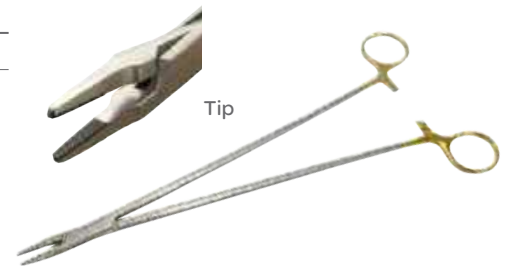

Wangensteen Classic Plus® Needle Holder

CODE	DESCRIPTION	LENGTH	
36-4020	Fine Tungsten Carbide Jaw Inserts	10 1/2 in	267 mm



Needle Holders

Crile-Wood Needle Holder

CODE	DESCRIPTION	LENGTH
32-3685	Fine Tungsten Carbide Insert	14 in 356 mm



Intracardiac Needle Holder

CODE	DESCRIPTION	LENGTH
32-368	Needle Holder	12 in 305 mm



Osteotomes



46-2001

Osteotome

CODE	DESCRIPTION	TIP WIDTH	LENGTH
46-2000	Straight	¼ in 6 mm	11 in 279 mm
46-2001	Straight	⅜ in 10 mm	11 in 279 mm
46-2002	Straight	½ in 13 mm	11 in 279 mm
46-2003	Straight	⅝ in 16 mm	11 in 279 mm
46-2004	Straight	¾ in 19 mm	11 in 279 mm
46-2005	Straight	1 in 25 mm	11 in 279 mm
46-2010	Curved	¼ in 6 mm	11 in 279 mm
46-2011	Curved	⅜ in 10 mm	11 in 279 mm
46-2012	Curved	½ in 13 mm	11 in 279 mm
46-2013	Curved	⅝ in 16 mm	11 in 279 mm
46-2014	Curved	¾ in 19 mm	11 in 279 mm
46-2015	Curved	1 in 25 mm	11 in 279 mm
46-2016	Curved	1¼ in 32 mm	11 in 279 mm



46-1019

Spinal Fusion Osteotome

CODE	DESCRIPTION	BLADE WIDTH	LENGTH
46-1025	Straight	6 mm	9½ in 241 mm
46-1019	Straight	10 mm	9½ in 241 mm
46-1024	Full Curved	6 mm	9½ in 241 mm

Pliers



Vice Grips

CODE	DESCRIPTION	LENGTH
37-4101	Vice Grips	7 in 180 mm

Probes (Spinal)



Probe With Eye

CODE	DESCRIPTION	LENGTH
49-4037	Probe	10 in 254 mm

Probes (Palpation)



Palpation Probe

CODE	DESCRIPTION	LENGTH
90-5053L	Probe	17 ³ / ₄ in 450 mm

Retractors

Balfour Abdominal Retractor

Standard Model: Fenestrated Blades 4 in Deep, with Center Blade 24-7073



CODE	MAX SPREAD
24-7017	10 in 254 mm

Balfour Abdominal Retractor



CODE	DESCRIPTION	DIMENSIONS
24-5200AA	Includes: Two Pairs Lateral Snap-On Wire Blades , Left Hand Assembly Provided Unless Specified Otherwise	8 ½ x 2 ½ x 3 ½ in 216 x 63 x 89 mm

Balfour Abdominal Retractor

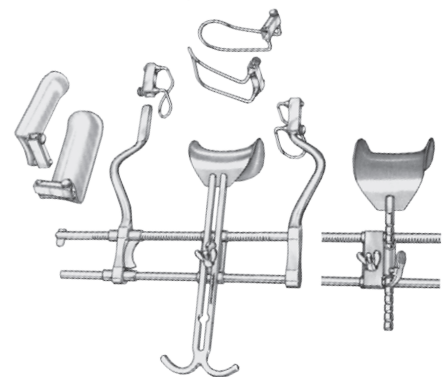

CODE	DESCRIPTION	DIMENSIONS
24-5200AAA	Includes: Two Pairs Lateral Snap-On Wire Blades, One Center Blade (Chosen From: 24-5012, 24-5014, 24-5022, 24-5024, 24-5026, 50-2428, 24-5030, 24-5032, 24-5034 or 24-5036) Left Hand Assembly Provided Unless Specified Otherwise.	8 ½ x 2 ½ x 3 ½ in 216 x 63 x 89 mm

OBESE PATIENT

Retractors (Bookwalter® Horizontal Bars)



Bookwalter® Lightweight Horizontal Bar

CODE	DESCRIPTION	QTY
50-4552	Table-Mounted	1



Bookwalter® Lightweight Horizontal Flex Bar

CODE	DESCRIPTION	QTY
50-4582	Table-Mounted	1

Retractors



Balfour Retractor Fourth Arm Retractor

CODE	DESCRIPTION	LENGTH
50-4526	Left	12 in 305 mm
50-4527	Right	12 in 305 mm
24-5062C	For Balfour Fourth Blade Attachment with Wing Nut	

Retractors



Balfour Supra-Pubic Retractor Blade

CODE	DESCRIPTION	BLADE
24-5024B	Deep	3 ³ / ₈ x 2 ³ / ₄ in 86 x 70 mm

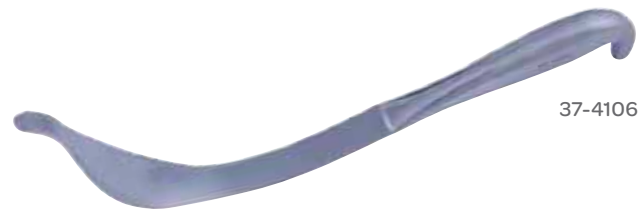

37-4106

Cobra Retractor

CODE	DESCRIPTION	TIP SIZE	LENGTH
37-4105	Sharp	1 ¹ / ₄ in	9 ³ / ₄ in 250 mm
37-4106	Blunt	1 ¹ / ₄ in	9 ³ / ₄ in 250 mm



32-3633

Cushing Retractor

CODE	JAW LENGTH	LENGTH
32-3633	10 mm	11 in 280 mm
32-3634	11 mm	14 in 355 mm

Retractors



50-4316

Deaver Retractor

CODE	DESCRIPTION	WIDTH		LENGTH	
50-4316	#1 Ring Grip Handle	1 in	25 mm	12 in	305 mm
50-4317	#4 Ring Grip Handle	1 in	25 mm	13 in	330 mm
50-4319	#3 Ring Grip Handle	1½	38mm	12 in	305 mm
50-4320	#4 Ring Grip Handle	2 in	51 mm	12 in	305 mm
50-4321	#5 Ring Grip Handle	3 in	76 mm	12 in	305 mm
50-4303	#1 Standard Handle	1 in	25 mm	12 in	305 mm
50-4304	#2 Standard Handle	1 in	25 mm	13 in	330 mm
50-4306	#3 Standard Handle	1½ in	38 mm	12 in	305 mm
50-4307	#4 Standard Handle	2 in	51 mm	12 in	305 mm
50-4308	#5 Standard Handle	3 in	76 mm	12 in	305 mm
50-4309	#6 Standard Handle	4 in	102 mm	14 in	356 mm
67-7498	# 4 Comfort Grip Handle	2 in	51 mm	12 in	305 mm

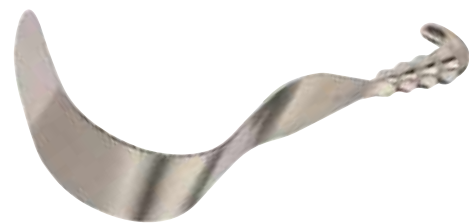

Deaver Obese Patient Retractor

CODE	DESCRIPTION	HANDLE LENGTH		BLADE		LENGTH	
32-3635	Grip Handle	14½ in	368 mm	2½ in	640 mm	14½ in	368 mm

Retractors

Gelpi Retractor

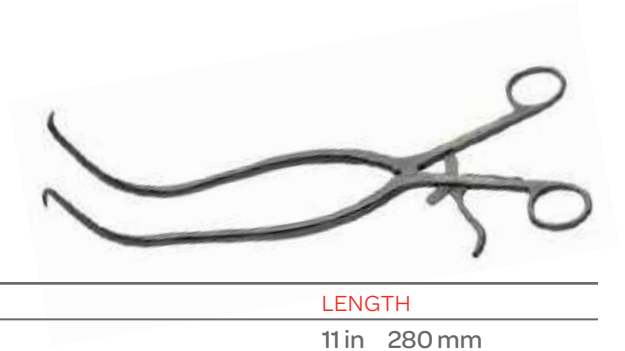

CODE	DESCRIPTION	WIDTH	LENGTH
67-7510	Sharp, Self-Retaining	15 mm	11 in 280 mm

Harrington Retractor

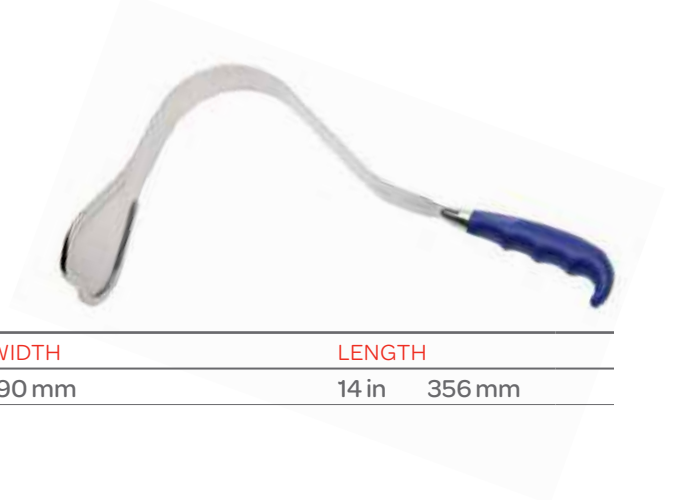

CODE	DESCRIPTION	BLADE WIDTH	LENGTH
67-7482	Comfort Grip Handle	3½ in 90 mm	14 in 356 mm

Harrington Retractor



CODE	DESCRIPTION	BLADE WIDTH	LENGTH
67-7505	Splanchnic, Lipped Distal Edge	2½ in 64 mm	20 in 508 mm

Retractors



Holsher Retractor

CODE	DESCRIPTION	BLADE WIDTH	LENGTH
50-1331	Nerve Root	$\frac{5}{16}$ in 7 mm	9 $\frac{3}{4}$ in 248 mm



50-4117

Kelly Retractor

CODE	DESCRIPTION	BLADE DIMENSION	LENGTH
50-4112	Large, Ring-Grip Handle	2 $\frac{1}{2}$ x 3 in 64 x 76 mm	10 in 254 mm
50-4117	Large, Grip Handle	2 $\frac{1}{2}$ x 3 in 64 x 76 mm	10 in 254 mm
67-7483	Grip Handle	3 x 3 in 76 x 76 mm	11 in 280 mm
67-7484	Grip Handle	3 x 4 in 76 x 102 mm	11 in 280 mm
67-7485	Grip Handle	3 x 5 in 76 x 127 mm	11 in 280 mm
67-7486	Grip Handle	3 x 3 in 76 x 76 mm	11 in 280 mm
67-7487	Grip Handle	3 x 4 in 76 x 102 mm	11 in 280 mm
67-7488	Grip Handle	3 x 5 in 76 x 127 mm	11 in 280 mm



677494

Kelly Retractor

Comfort Grip Handle

CODE	BLADE DIMENSION	LENGTH
677489	3 x 3 in 76 x 76 mm	11 in 280 mm
677490	3 x 4 in 76 x 102 mm	11 in 280 mm
677491	3 x 5 in 76 x 127 mm	11 in 280 mm
677492	3 x 3 in 76 x 76 mm	13 in 330 mm
677493	3 x 4 in 76 x 102 mm	13 in 330 mm
677494	3 x 5 in 76 x 127 mm	13 in 330 mm

Retractors



23-4701

Kelly Retractor

Ring Grip Handle

CODE	DESCRIPTION	BLADE DIMENSION		LENGTH	
50-4111	Standard Handle, Medium	2 x 2½ in	51 x 64 mm	9½ in	241 mm
50-4118	Grip Handle, XL	3 x 3½ in	76 x 89 mm	10 in	254 mm
23-4701	Standard Handle	1½ x 2 in		10¼ in	260 mm
23-4702	Standard Handle	2 x 2½ in		10¼ in	260 mm
23-4703	Standard Handle	2½ x 3 in		10¼ in	260 mm
23-4711	Lamb Handle	1¼ x 2 in		10¼ in	260 mm
23-4712	Lamb Handle	2 x 2½ in		10¼ in	260 mm
23-4713	Lamb Handle	2½ x 3 in		10¼ in	260 mm
23-4714	Lamb Handle	3 x 3½ in		10¼ in	260 mm
23-4715	Grip Handle	1½ x 2 in		10¼ in	260 mm
23-4716	Grip Handle	2 x 2½ in		10¼ in	260 mm
23-4717	Grip Handle	2½ x 3 in		10¼ in	260 mm
23-4718	Grip Handle	3 x 3½ in		10¼ in	260 mm



67-7470

Ollier Retractor

Blunt, Four Prongs

CODE	DESCRIPTION	WIDTH	LENGTH	
67-7470		2¼ in	11 in	280 mm
67-7471		2¼ in	13 in	330 mm

Retractors

Ribbon Retractor

22-0006

Malleable



CODE	DESCRIPTION	WIDTH		LENGTH	
22-0006	Malleable, Stainless Steel	¼ in	6 mm	8 in	203 mm
22-0012	Malleable, Stainless Steel	½ in	13 mm	8 in	203 mm
22-0017	Malleable, Stainless Steel	⅝ in	16 mm	8 in	204 mm
22-0027	Malleable, Stainless Steel	1 in	25 mm	10 in	254 mm
22-0252	Malleable, Stainless Steel	1 in	25 mm	13 in	330 mm
22-0253	Malleable, Stainless Steel	1¼ in	32 mm	13 in	330 mm
22-0254	Malleable, Stainless Steel	1½ in	38 mm	13 in	330 mm
22-0255	Malleable, Stainless Steel	2 in	51 mm	13 in	330 mm
22-0256	Malleable, Stainless Steel	2½ in	64 mm	13 in	330 mm
22-0257	Malleable, Stainless Steel	3 in	76 mm	13 in	330 mm
22-0258	Malleable, Stainless Steel	4 in	102 mm	13 in	330 mm
22-0259	Malleable, Stainless Steel	5 in	127 mm	13 in	330 mm



50-4212

Ribbon Malleable Retractor

CODE	DESCRIPTION	WIDTH		LENGTH	
50-5637	Malleable Retractor	½ in	13 mm	8 in	203 mm
50-5638	Malleable Retractor	⅝ in	16 mm	8 in	203 mm
50-5639	Malleable Retractor	¾ in	19 mm	8 in	203 mm
50-4210	Malleable Retractor	1 in	25 mm	13 in	330 mm
50-4212	Malleable Retractor	1½ in	38 mm	13 in	330 mm
50-4214	Malleable Retractor	2 in	51 mm	13 in	330 mm

Richardson Retractor

Standard Handle



50-4122

CODE	DESCRIPTION	WIDTH		LENGTH	
50-4122	Large	1½ x 1¾ in	38 x 44 mm	9½ in	241 mm
23-4550	Set of Two, Double-Ended				
23-4551	Small Only, Double-Ended				
23-4552	Large Only, Double-Ended				

Retractors



677462

Volkman Retractor

CODE	DESCRIPTION	BLADE WIDTH	LENGTH
677462	Sharp, Four Prong	25 mm	12 in 305 mm
677464	Sharp, Four Prong	25 mm	14 in 356 mm
677466	Sharp, Six Prong	40 mm	12 in 305 mm
677468	Sharp, Six Prong	40 mm	14 in 356 mm
677463	Blunt, Four Prong	25 mm	12 in 305 mm
677465	Blunt, Four Prong	25 mm	14 in 356 mm
677467	Blunt, Six Prong	40 mm	12 in 305 mm
677469	Blunt, Six Prong	40 mm	14 in 356 mm



677508

Weitlaner Retractor

Self-Retaining

CODE	DESCRIPTION	DIMENSIONS	LENGTH
677508	Sharp	2 x 1½ in 51 x 38 mm	14 in 356 mm
677509	Blunt	2 x 1½ in 51 x 38 mm	14 in 356 mm

Retractors (Abdominal)



Balfour Abdominal Retractor

Contains Two Pair of Lateral Snap on Wire Blades, One Center Blade (Other Blade Sizes Available)

CODE	CENTER BLADE	LATERAL SNAP ON BLADE DEPTH
24-5200A	2½ x 1¾ in	2½ in and 3½ in

Retractors (Blade)



24-7071

Balfour Retractor Blade

CODE	DESCRIPTION	LENGTH	
24-7071	Center Blade	2½ x 1½ in	64 x 38 mm
24-7072	Center Blade	3 x 2 in	76 x 51 mm
24-7073	Center Blade	3¾ x 2½ in	86 x 64 mm
24-7074	Center Blade	3⅛ x 2⅞ in	79 x 73 mm
24-5032B	Center Blade	2½ x 3½ in	64 x 89 mm
24-7075	Center Blade	2¾ x 4 in	70 x 102 mm



50-4524

Horgan Center Retractor Blade

CODE	DESCRIPTION	BLADE	LENGTH
50-4524	Malleable Center Blade	2 x 7 in 51 x 197 mm	14¾ in 375 mm
677507	Obese Blade, 2 in (51 mm), for Use With 504500		11 in 280 mm

Retractors (Bookwalter® Bars)

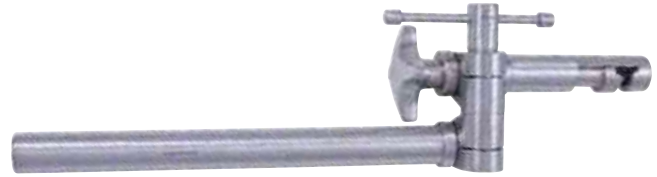

Bookwalter® Horizontal Bar

CODE	DESCRIPTION
50-4678	Horizontal Ring Holder



Bookwalter® Lightweight Horizontal Bar

CODE	DESCRIPTION
50-4618	Horizontal Bar, Lightweight Design that can be Back Fed into the Bookwalter® Coupler



50-4553

Bookwalter® Lightweight Extension Bar

50-4553 and 50-4797 Require the Use of a Second Bookwalter® Post Coupler 50-4554

CODE	DESCRIPTION	DIMENSION
50-4553	Lightweight Extension Bar	12 in 305 mm
50-4797	Lightweight Extension Bar	18 in 458 mm

Retractors (Bookwalter® Blades)



Bookwalter® Balfour Blade

CODE	DIMENSION
BW1271017	3½ x 2¾ in 89 x 70 mm

Retractors (Bookwalter® Blades)

Bookwalter® Harrington Blade

CODE	LENGTH
BW1045176	3½x10 in 89x254 mm



50-4571

Bookwalter® Kelly Blade

CODE	LENGTH
50-4571	2x6 in 51x152 mm
677496	2x7 in 51x178 mm
BW1045000	2x8 in 51x203 mm
677497	2x8 in 51x203 mm
677501	3x11 in 76x280 mm



67-7499

Bookwalter® OptiLength Malleable Blade

Malleable with Lip

CODE	WIDTH	LENGTH
677502	1½ in 38 mm	11 in 280 mm
677504	2 in 51 mm	11 in 279 mm
677499	3 in 76 mm	11 in 279 mm
677500	4 in 102 mm	11 in 279 mm
677506	2 in 51 mm	12 in 305 mm
677503	1 in 25 mm	13 in 330 mm

Retractors (Bookwalter® Blades)



Bookwalter® Radiolucent Titanium Retractor Blade

505584

CODE	WIDTH	LENGTH
505583	1 in 25 mm	7 in 178 mm
505584	1 in 25 mm	8 in 203 mm
505588	2 in 51 mm	7 in 178 mm
505589	2 in 51 mm	8 in 203 mm



50-4561

Bookwalter® Retractor Blade

Malleable

CODE	DIMENSIONS
50-4561	2x6 in 51x152 mm
BW1043016	2x10 in 51x254 mm
50-4567	3x6 in 76x152 mm
BW1043029	3x10 in 76x254 mm
BW1045069	4x8 in 102x203 mm



50-4672

Bookwalter® Retractor Blade

Malleable with Lip

CODE	DIMENSIONS
50-4673	2x6 in 51x152 mm
50-4672	1½x6 in 38x152 mm
50-4674	3x6 in 76x152 mm

Retractors (Bookwalter® Ratchets)

Bookwalter® Ratchet

CODE	DESCRIPTION
50-4579	Flat Ratchet



Bookwalter® Ratchet Extender

CODE	DESCRIPTION
BW0338014	A Bookwalter® Extender provides the surgeon with the extra length that is sometimes needed to get a blade positioned in 'just the right spot.' Can be used with any Bookwalter® Retractor.

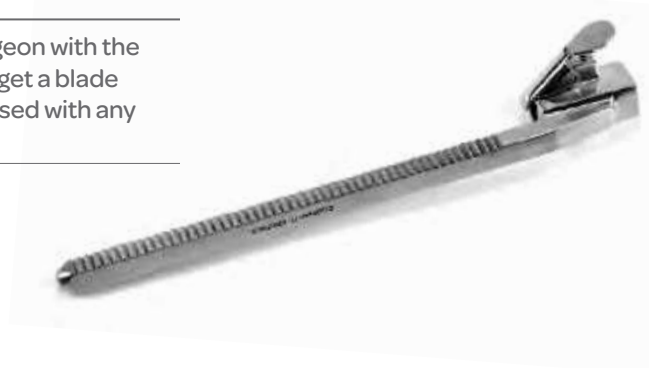

Bookwalter® Self-Retaining Low Profile Locking RoTilt

CODE	DESCRIPTION	QTY
50-4696	The Bookwalter® Self-Retaining Low Profile Locking RoTilt Ratchet brings all of the best features of all other ratchets into one mechanism. The low profile design, inclusive of the capacity to tilt, rotate and self-retention it is the one ratchet to build your Bookwalter® Set.	1/Each Sold Individually



Retractors (Bookwalter® Ratchets)

Bookwalter® Self-Retaining Tilt Ratchet

CODE	DESCRIPTION	QTY
50-4686	Like the 50-4580 this ratchet articulates the blade into the surgical site, it also has an additional self-retention latch that holds the ratchet onto the Bookwalter® Retractor Ring.	1/Each Sold Individually



OBESE PATIENT

Bookwalter® Tilt Ratchet Mechanism

CODE	DESCRIPTION	QTY.
50-4580	Tilt Ratchet Mechanisms	6



Bookwalter® Twister Ratchet

CODE	DESCRIPTION	QTY
BW0338015	The Bookwalter® Twister Ratchet is compatible with all Bookwalter® Ratchets and Retractor Blades. It allows controlled fine tuning of blade position with the simple turn of the key.	1/Each Sold Individually



Retractors (Bookwalter® Rings)

Bookwalter® Elliptical Ring

For Obese Patients



CODE	DESCRIPTION	LENGTH
50-4595	Segmented	14 ½ x 15 in 368 x 381 mm

Bookwalter® Oval Ring

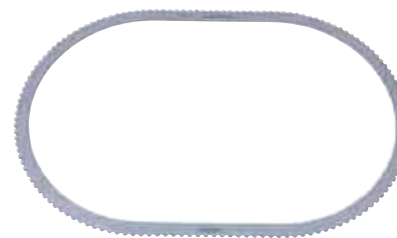

CODE	DESCRIPTION	DIMENSIONS
50-4556	Large	12 x 18 ½ in 305 x 470 mm

Bookwalter® Round Ring



CODE	DESCRIPTION	LENGTH
50-4633	Large, with Suture Slots	16 in 406 mm

Retractors (Bookwalter® Rings)



Bookwalter® Segmented Ring

CODE	DESCRIPTION	DIMENSIONS
50-4588	Large, Consists of One 12½ in Round Ring and Two 6 in Straight Segments	12½ x 19½ in 318 x 495 mm

OBESE PATIENT



50-4587

Bookwalter® Segmented Ring

Straight Ring Segment, Pair

CODE	LENGTH
50-4636	4 in 102 mm
50-4637	6 in 152 mm
50-4638	8 in 203 mm

Retractors (Bookwalter® Couplings)



Bookwalter® Lightweight Post Coupling

CODE	DESCRIPTION	WIDTH
50-4554	Coupler	1 x 4 in 25 x 102 mm

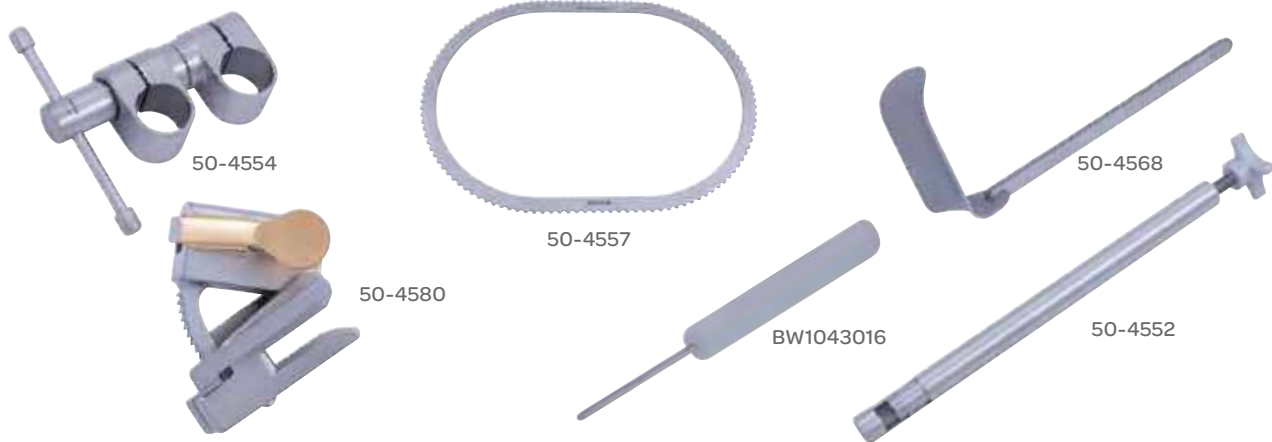

Bookwalter® Obese Patient Retractor System, 18 in (458 mm) Table Post

CODE	DESCRIPTION	LENGTH	QTY
BW1046BKIT	Includes Part Numbers Listed Below:		
BW0144005	18 in Table Post Obese Patients	1 x 1 in 25 x 25 mm	1
50-4554	Post Coupling		1
50-4552	Retractor Horizontal Bar		1
50-4557	Retractor, Oval Ring Medium		1
50-4580	Tilt Ratchets		6
BW0338014	Ratchet Extender		1
BW0338015	Twister Ratchet		1
BW1271017	Balfour Blade	3 ½ x 2 ¾ in 89 x 70 mm	1
BW1045176	Harrington Blade	3 ½ x 10 in 89 x 254 mm	1
50-4568	Kelly Retractor Blades	2 x 3 in 51 x 76 mm	1
50-4569	Kelly Retractor Blades	2 x 4 in 51 x 102 mm	1
BW1045000	Kelly Blade	2 x 8 in 51 x 203 mm	1
BW1043016	Malleable Blade	2 x 10 in 51 x 254 mm	1
BW1043029	Malleable Blade	3 x 10 in 76 x 254 mm	1
BW1045069	Malleable Blade	4 x 8 in 102 x 203 mm	1

Retractors (Bookwalter® Sets)



BW1046BRT

Bookwalter® Obese Patient Accessory Kit, 18 in (458 mm) Table Post

CODE	DESCRIPTION	LENGTH	QTY
BW1046BRT	Includes Part Numbers Listed Below:		
BW0144005	18 in Table Post Obese Patients		1
BW0338014	Ratchet Extender		1
BW0338015	Twister Ratchet		1
BW1271017	Balfour Blade	3½ x 2¾ in 89 x 70 mm	1
BW1045176	Harrington Blade	3½ x 10 in 89 x 254 mm	1
BW1045000	Kelly Blade	2 x 8 in 51 x 203 mm	1
BW1043016	Malleable Blade	2 x 10 in 51 x 254 mm	1
BW1043029	Malleable Blade	3 x 10 in 76 x 254 mm	1
BW1045069	Malleable Blade	4 x 8 in 102 x 203 mm	1



BW1045BRT

Bookwalter® Obese Patient Accessory Kit, 24 in (610 mm) Table Post

CODE	DESCRIPTION	LENGTH	QTY
BW1045BRT	Includes Part Numbers Listed Below:		
BW0144003	24 in Table Post		1
BW0338014	Ratchet Extender		1
BW0338015	Twister Ratchet		1
BW1271017	Balfour Blade	3½ x 2¾ in 89 x 70 mm	1
BW1045176	Harrington Blade	3½ x 10 in 89 x 254 mm	1
BW1045000	Kelly Blade	2 x 8 in 51 x 203 mm	1
BW1043016	Malleable Blade	2 x 10 in 51 x 254 mm	1
BW1043029	Malleable Blade	3 x 10 in 76 x 254 mm	1
BW1045069	Malleable Blade	4 x 10 in 102 x 203 mm	1

Retractors (Bookwalter® Sets)

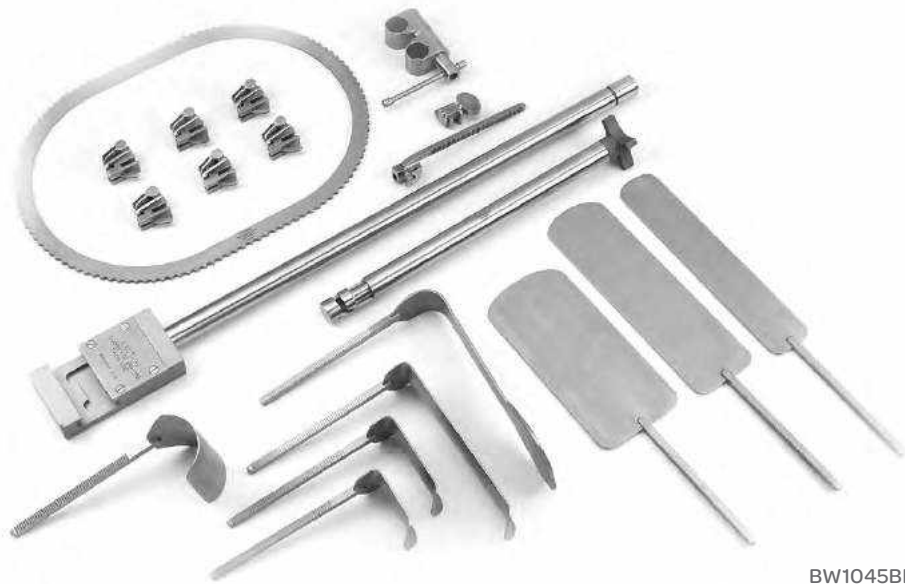

BW1045BKIT

Bookwalter® Obese Patient Retractor System, 24 in (610 mm) Table Post

CODE	DESCRIPTION	LENGTH	QTY
BW1045BKIT	Includes Part Numbers Listed Below:		
BW0144003	Table Post		1
BW1043016	Malleable Blade	2 x 10 in 51 x 254 mm	1
BW1043029	Malleable Blade	3 x 10 in 76 x 254 mm	1
BW1045069	Malleable Blade	4 x 8 in 102 x 203 mm	1
BW1271017	Balfour Blade	3½ x 2¾ in 89 x 70 mm	1
BW1045176	Harrington Blade	3½ x 10 in 89 x 254 mm	1
BW0338014	Ratchet Extender		1
BW0338015	Twister Ratchet		1
50-4552	Horizontal Bar		1
50-4554	Post Coupling	1 x 1 in 25 x 25 mm	1
50-4557	Medium Oval Ring		1
50-4568	Kelly Blade	2 x 3 in 51 x 76 mm	1
50-4569	Kelly Blade	2 x 4 in 51 x 102 mm	1
BW1045000	Kelly Blade	2 x 8 in 51 x 203 mm	1
50-4580	Tilt Rachets		6

Retractors (Bookwalter® Systems)



504810

Bookwalter® Adaptable Ring System

CODE	DESCRIPTION
50-4810	System includes the Horizontal Bar and dual ball joint hinge system as well as the Small Round, Medium Round, and Medium Oval Ring Segments
50-4811	Small, Round Ring Segments
50-4812	Medium, Round Ring Segments
50-4813	Medium, Oval Ring Segments



Bookwalter® Adaptable Ring System Bridge

CODE	DESCRIPTION
50-4687	For use with 50-4810

Retractors (Bookwalter® Table Posts)



BW014403

Bookwalter® Table Post

CODE	DESCRIPTION	LENGTH
BW0144005	18 in	18 in 460 mm
BW0144003	24 in	24 in 601 mm



504688

Bookwalter® Lightweight Table Post

CODE	DESCRIPTION	LENGTH
504688	Lightweight Table Post	12 in 305 mm
504697	Lightweight Table Post	16 in 406 mm

Retractors (Laminectomy)



50-1160

Beckman-Adson Laminectomy Retractor

Self-Retaining with Hinged Arms

CODE	DESCRIPTION	TOTAL OPENING		BLADE		LENGTH	
50-1160	Blunt, Four Prong	5 in	127 mm	1 x 1¼ in	25 x 32 mm	12 in	305 mm
50-1161	Sharp, Four Prong	5 in	127 mm	1 x 1 in	25 x 25 mm	12 in	305 mm
50-1162	X-Long, Four Prong,	5½ in	140 mm	1 x 1¾ in	25 x 44 mm	12 in	305 mm
50-1163	Seven Prong	5½ in	140 mm	1¾ x 1⅞	44 x 78 mm	12¾ in	324 mm



50-1066

Meyerding Laminectomy Retractor

CODE	DESCRIPTION	BLADE		LENGTH	
50-1066	Medium	1 x 3 in	25 x 76 mm	9½ in	241 mm
50-1067	Large	2 x 3½ in	51 x 89 mm	9½ in	241 mm

Retractors (Rectal)



Sawyer Rectal Retractor

CODE	BLADE
50-5671	1⅞ x 3⅞ in 29 x 79 mm

Retractors (Thyroid)



Beckman Retractor

Self-Retaining with Hinged Arms

CODE	DESCRIPTION	BLADE	TOTAL OPENING	LENGTH
50-1165	Sharp, Four Prong	¾ x 1 in	5½ in 140 mm	12 in 305 mm

Retractors (Abdominal)

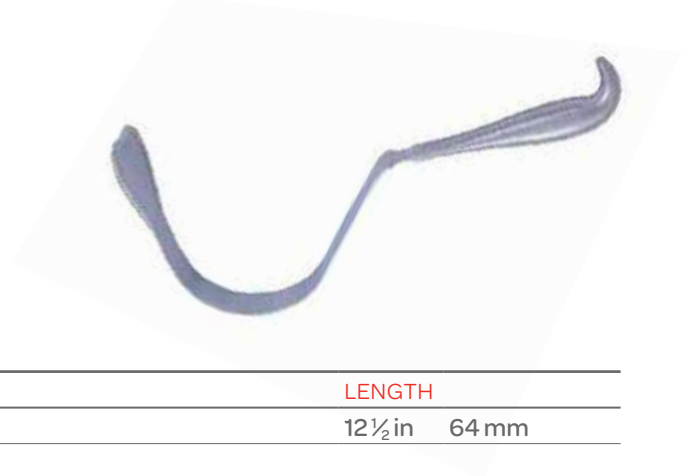

Harrington Splanchnic Retractor

CODE	BLADE	LENGTH
50-8102	2½ in 64 mm	12½ in 64 mm

Retractors (Obstetric)



Delee Universal Retractor

CODE	BLADE
50-5575	2¾ x 2 in 70 x 51 mm

Retractors (Vaginal)

Heaney-Simon Vaginal Retractor



CODE	BLADE	LENGTH
50-5570	1 x 4 1/2 in 25 x 114 mm	11 in 279 mm

Retractors (Vein)

Cushing Vein Retractor



CODE	DESCRIPTION	LENGTH
20-1728	8 mm Wide	9 1/2 in 240 mm

Rongeurs

Cloward Opti-Length® Rongeur

CODE	DESCRIPTION	LENGTH
67-7324	6 x 10 Cup	11 in 279 mm



Rongeurs

Stille-Luer Rongeur

Angular, 5 mm Bite

CODE	DESCRIPTION	LENGTH
53-1133		9½ in 241 mm
53-1118	Flat Lower Jaw	9½ in 241 mm

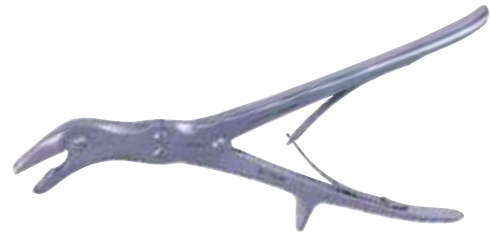

Rongeurs (Laminectomy)

Fulton Laminectomy Rongeur

15 x 16 Cup, Narrow Blade

CODE	DESCRIPTION	LENGTH
53-1066	Straight, Double-Action	9½ in 241 mm

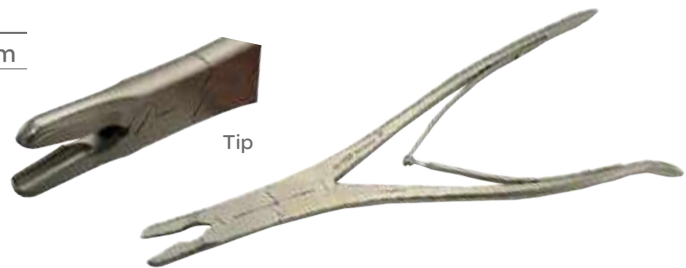

Rongeurs (IVD)

Love-Gruenwald Opti-Length® Rongeur, IVD

3 x 10 Cup

CODE	DESCRIPTION	LENGTH
67-7319	Straight	11 in 279 mm
67-7320	30° Up	11 in 279 mm

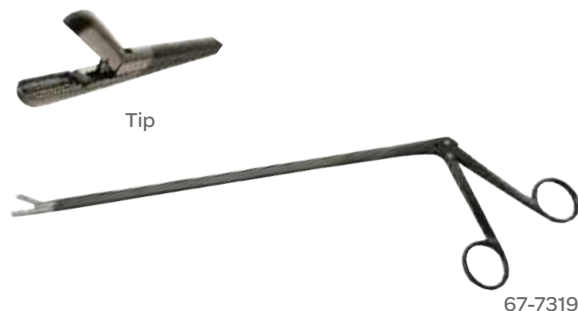

Rongeurs (IVD)

Spurling Opti-Length® Rongeur, LVD

4 x 10 Cup

CODE	DESCRIPTION	LENGTH
67-7321	Straight	11 in 279 mm
67-7322	Up Biting	11 in 279 mm



Rongeurs (Lumbar)

Kerrison Lumbar Rongeur

CODE	DESCRIPTION	BITE	LENGTH
53-1426	40° Angle Up, Hardy™ Style Handle with Ball Spring	3 mm	11 in 279 mm
53-1428	40° Angle Up, Hardy™ Style Handle with Ball Spring	5 mm	11 in 279 mm
53-1429	40° Angle Up, Hardy™ Style Handle with Ball Spring	6 mm	11 in 279 mm
67-7325	40° Angle Up	1 mm	15 in 380 mm
67-7326	40° Angle Up	2 mm	15 in 380 mm
67-7327	40° Angle Up	3 mm	15 in 380 mm
67-7328	40° Angle Up	4 mm	15 in 380 mm
67-7329	40° Angle Up	5 mm	15 in 380 mm
67-7330	90° Up	1 mm	15 in 380 mm
67-7331	90° Up	2 mm	15 in 380 mm
67-7332	90° Up	3 mm	15 in 380 mm
67-7333	90° Up	4 mm	15 in 380 mm
67-7334	90° Up	5 mm	15 in 380 mm
677282	40° Up, Hardy™ Style Handle	2 mm	12 in 305 mm
677285	40° Up, Hardy™ Style Handle	3 mm	12 in 305 mm
677288	40° Up, Hardy™ Style Handle	4 mm	12 in 305 mm

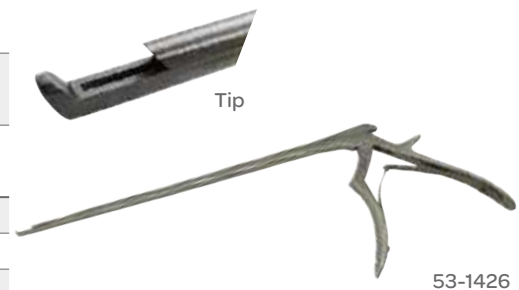

Rongeurs (Rib)

Dale First Rib Rongeur

Double-Action

CODE	BITE	LENGTH
56-8040	1/8 in 3 mm	14 1/2 in 368 mm



Ferris-Smith Rongeur

CODE	DESCRIPTION	JAW SIZE	LENGTH
677323	Straight	3 x 10 mm	11 x 280 mm
677324	Straight	6 x 10 mm	11 x 280 mm



Rongeurs (IVD)

IVD Rongeur

CODE	DESCRIPTION	JAW SIZE	LENGTH
67-7319	Straight	3 x 10 mm	11 in 280 mm
67-7321	Straight	4 x 10 mm	11 in 280 mm
67-7320	30° Up Bite	3 x 10 mm	11 in 280 mm
67-7322	30° Up Bite	4 x 10 mm	11 in 280 mm



Rongeurs (Kerrison)

Microsect® Shaver

45° Up Bite

CODE	TIP WIDTH	LENGTH	
677314	1.5 mm	12 in	305 mm
677315	2 mm	12 in	305 mm
677316	2.5 mm	12 in	305 mm
677317	3 mm	12 in	305 mm
677318	4 mm	12 in	305 mm



Stille-Luer

Double-Action

CODE	DESCRIPTION	LENGTH	
67-7240	Straight, 10 mm Jaw	11 in	280 mm
67-7242	Straight, 10 mm Jaw	13 in	330 mm
67-7239	Angled, 5 mm Jaw	11 in	280 mm
67-7241	Angled, 5 mm Jaw	13 in	330 mm



Scissors

DeBakey-Metzenbaum Scissors

Fine Tungsten Carbide Edges

CODE	DESCRIPTION	LENGTH
32-3576	Straight	12 ¼ in 311 mm



Scissors

Diethrich Valve Scissors

Classic Plus®, Stellite Inserts, Serrated Blade

CODE	DESCRIPTION	LENGTH
67-7665	Full Curved, 4 mm	12 in 305 mm



Doyen Scissors

Classic Plus®, Stellite Inserts, Beveled

CODE	DESCRIPTION	LENGTH
67-7663	Blunt	8 mm 280 mm
67-7664	Curved, Blunt	8 mm 280 mm



677663

Leksell Rongeur

Double-Action, Curved

CODE	DESCRIPTION	LENGTH
67-7900	1 mm	14 mm 356 mm
67-7901	2 mm	14 mm 356 mm
67-7902	3 mm	14 mm 356 mm
67-7903	4 mm	14 mm 356 mm
67-7904	5 mm	14 mm 356 mm
67-7905	6 mm	14 mm 356 mm



67-7905

Scissors

Leksell Rongeur

Double-Action, Full Curve

CODE	DESCRIPTION	LENGTH
67-7912	1 mm	14 in 356 mm
67-7913	2 mm	14 in 356 mm
67-7914	3 mm	14 in 356 mm
67-7915	4 mm	14 in 356 mm
67-7916	5 mm	14 in 356 mm
67-7917	6 mm	14 in 356 mm



Leksell Rongeur

Double-Action, Curve

CODE	DESCRIPTION	LENGTH
67-7906	1 mm	14 in 356 mm
67-7907	2 mm	14 in 356 mm
67-7908	3 mm	14 in 356 mm
67-7909	4 mm	14 in 356 mm
67-7910	5 mm	14 in 356 mm
67-7911	6 mm	14 in 356 mm



Leksell Rongeur

Double-Action, Full Curve

CODE	DESCRIPTION	LENGTH
67-7918	1 mm	14 in 356 mm
67-7919	2 mm	14 in 356 mm
67-7920	3 mm	14 in 356 mm
67-7921	4 mm	14 in 356 mm
67-7922	5 mm	14 in 356 mm
67-7923	6 mm	14 in 356 mm



OBESE PATIENT

Scissors

Mayo Scissors

Beveled Blades

CODE	DESCRIPTION	LENGTH
03-5131	Straight	12 in 305 mm
32-3592	Straight	14 in 356 mm
03-5040	Straight	16 in 405 mm
03-5045	Straight	18 in 455 mm
03-5132	Curved	12 in 305 mm
32-3593	Curved	14 in 356 mm
03-5130	Curved	14½ in 359 mm
03-5145	Curved	18 in 455 mm



32-3592

Mayo Scissors

Classic Plus®, Stellite Inserts, Beveled, Standard, Curved

CODE	DESCRIPTION	LENGTH
677637	Blunt, 4 mm	14 in 356 mm



Mayo-Harrington Scissors

CODE	DESCRIPTION	LENGTH
32-3592	Straight	14 in 356 mm
32-3593	Curved	14 in 356 mm



32-3593

Scissors

Metzenbaum Scissors

CODE	DESCRIPTION	LENGTH
32-794	Straight, Fine Tungsten Carbide	12 in 305 mm
32-793	Curved, Delicate	10 in 254 mm
32-3594	Curved	12¼ in 311 mm
32-3596	Curved, Super Cuts	13⅞ in 355 mm



32-3594

Metzenbaum Classic Plus® Dissecting Scissors

Stellite Inserts

CODE	DESCRIPTION	LENGTH
677643	Curved, Blunt/Blunt	11 in 279 mm
677644	Curved, Blunt/Blunt	13 in 330 mm
677645	Curved, Blunt/Blunt	15 in 381 mm
677648	Curved, Blunt/Blunt, Delicate	11 in 279 mm
677646	Curved, Blunt/Blunt, Delicate	14 in 356 mm
677647	Curved, Blunt/Blunt, Super Delicate	14 in 356 mm
677640	Curved, Sharp/Sharp	11 in 279 mm
677641	Curved, Sharp/Sharp	13 in 330 mm
677642	Curved, Sharp/Sharp	15 in 355 mm



677643

Nelson Classic Plus® Scissors

Stellite Edge Inserts

CODE	DESCRIPTION	LENGTH
36-5070	Curved, Standard	11 in 279 mm



Scissors

Nelson-Metzenbaum Scissors

Curved, Regular Tips, Fine Tungsten Carbide Inserts

CODE	DESCRIPTION	LENGTH
32-880		11 in 279 mm
32-881	Delicate Tip	11 in 279 mm
32-882		12 in 305 mm
32-799		14 in 356 mm
32-899		16 in 406 mm
32-999		18 in 457 mm



32-881

Zep Scissors

Fine Tungsten Carbide Blades

CODE	DESCRIPTION	LENGTH
32-892	Curved	10 ½ in 265 mm
32-895	Curved	12 in 305 mm
32-893	Full Curve	10 ½ in 265 mm
32-896	Full Curve	12 in 305 mm
32-898	Full Curve	14 in 356 mm
32-891	Slight Curve	10 ½ in 265 mm



32-892

Mayo-Harrington Dissecting Scissors

Slender Pattern

CODE	DESCRIPTION	LENGTH
03-5226	Straight	11 ¾ in 298 mm
03-5326	Curved	11 ½ in 290 mm
03-5330	Curved	14 in 350 mm



03-5330

Metzenbaum Dissecting Scissors

CODE	DESCRIPTION	LENGTH
54-1037	Curved	10 in 254 mm



Scissors (Dissecting)

Nelson-Metzenbaum Dissecting Scissors

Standard Pattern

CODE	DESCRIPTION	LENGTH
04-3226	Straight	10 ¼ in 260 mm
04-3230	Straight	11 ¾ in 300 mm
04-3232	Straight	14 ½ in 368 mm
04-3245	Straight	18 in 455 mm
04-3326	Curved	10 ¼ in 260 mm
04-3330	Curved	12 in 305 mm
04-3338	Curved	12 in 305 mm
04-3332	Curved	14 in 356 mm
04-3340	Curved	16 in 405 mm
04-3345	Curved	18 in 455 mm

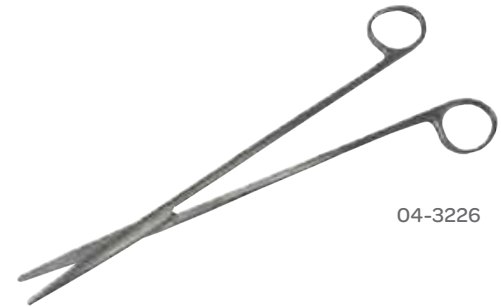

Scissors (Valve)

Litwak Mitral Valve Scissors

CODE	DESCRIPTION	LENGTH
54-8023	Angled on Side	11 in 279 mm



Shears (Rib)

Coryllos Rib Shears

CODE	DESCRIPTION	LENGTH
56-8055	Left	14 in 356 mm
56-8056	Right	14 in 356 mm



Shears (Rib)

Coryllos Rib Shears

CODE	DESCRIPTION	LENGTH
56-8055	Left	14 in 356 mm
56-8056	Right	14 in 356 mm



56-5055

Sauerbruch Rib Shears

CODE	DESCRIPTION	LENGTH
56-8051		10 ½ in 267 mm



Stille Giertz Rib Shears

CODE	DESCRIPTION	LENGTH
56-8044		10 in 254 mm



Spatulas (Elevator)



Woodson Elevator Spatula

CODE	DESCRIPTION	BLADE	LENGTH
59-1000	Double-Ended, Semi-Sharp	1/8 x 1 1/2 in 3 x 13 mm	1/8 x 1 1/2 x 10 in 3 x 13 x 254 mm

Spreaders (Lamina)



Lamina Spreader

CODE	DESCRIPTION	JAW OPENING	LENGTH
61-2525		2 in 51 mm	9½ in 241 mm

Suction Tubes



70-6560

Andrews-Pynchon Suction Tube

CODE	DESCRIPTION	LENGTH
70-6560	Stainless Steel	9½ in 241 mm
67-7675	Stainless Steel, 6 mm	11 in 280 mm



70-4002

Poole Suction Tube

Straight Tubing Connection

CODE	DESCRIPTION	LENGTH
70-4001		30 French x 9 5/8 in 30 French x 244 mm
70-4002	With Finger Cut-Off	30 French x 10 1/4 in 30 French x 260 mm

Suction Tubes



70-1161

Sachs Suction Tube

CODE	DESCRIPTION	SHAFT	LENGTH
70-1160	Small	9 ⁵ / ₈ in 241 mm	8 French x 4 in 8 French x 102 mm
70-1161	Large	9 ⁵ / ₈ in 241 mm	15 French x 4 1/2 in 15 French x 114 mm



32-3360

Suction Tube

CODE	DESCRIPTION	WORKING DISTANCE	LENGTH
32-3360		9 1/2 in 241 mm	12 in 305 mm
32-3361		13 1/8 in 323 mm	15 in 380 mm



32-3362

Yankauer Suction Tube

CODE	DESCRIPTION	WORKING DISTANCE	LENGTH
70-4026	Removable Tip, Standard		10 ³ / ₈ in 264 mm
70-4024	with Thumb Control		11 ¹ / ₄ in 254 mm
32-3362	with Thumb Control	5 ⁷ / ₈ x 12 ³ / ₄ in 148 x 325 mm	12 ³ / ₄ in 325 mm
09-8600			14 in 355 mm

Suction Tubes



Cooley Opti-Length® Left Ventricular Sump

CODE	DESCRIPTION	TIP WIDTH	LENGTH
67-7677	45°, Perforated	5/16 in	19 3/4 in 502 mm

Suction Tubes (Tube)



Andrews-Pynchon Opti-Length® Suction Tube

CODE	LENGTH
67-7675	11 in 279 mm

Suction Tubes (Vascular)



Methodist Vascular Suction Tube

CODE	LENGTH
70-8040	3/8 x 10 in 10 x 254 mm