



Scan the code above to learn more about our Ophthalmology portfolio.

Ophthalmology Portfolio



symmetry surgical™

Ophthalmology



Blades	OPH-2	Markers	OPH-39
Calipers	OPH-2	Needles	OPH-40
Cannulas	OPH-3	Needle Holders	OPH-41
Clamps	OPH-8	Plates	OPH-45
Curettes	OPH-8	Probes	OPH-45
Depressors	OPH-9	Retractors	OPH-46
Dilators	OPH-10	Rings	OPH-48
Forceps	OPH-11	Rotators	OPH-49
Gauges	OPH-27	Scissors	OPH-50
Hooks	OPH-27	Shields	OPH-67
Introducers	OPH-34	Spatulas	OPH-67
Intubation Sets	OPH-34	Speculums	OPH-69
Knives	OPH-35	Spoons	OPH-72
Lens Crackers	OPH-35	Spuds	OPH-73
Loops	OPH-36	Tonometers	OPH-73
Manipulators	OPH-37		

Questions? Contact us at customerservice@symmetrysurgical.com or learn more at symmetrysurgical.com



The Surgical Instrument Desk Reference

How to Use Our Catalog

The Symmetry Surgical catalog is designed with you in mind, to be your trusted resource for surgical instrumentation. We took great care in creating an easy-to-use, robust catalog and we think you'll be pleased with the design as you become more familiar with our broad portfolio.

Layout

The catalog is organized by surgical specialty *and* product function.

And we know that it is difficult to pick up an instrument and know what specialty it's listed in. To make your job easier, we've sorted the instruments in our portfolio by surgical function, too, including Energy, Laparoscopic, Retractors and Sterilization Solutions.

U.S. Customer Service

Your Symmetry Surgical Customer Service team wants to make ordering surgical instruments the easiest part of your day. We accept orders via phone, fax, email, our website, Global Healthcare Exchange (GHX) and through the mail.

PHONE

1.800.251.3000

(Available Monday through Friday, 8:30 AM–6:30 PM EST)

FAX

1.800.342.3272

EMAIL

customerservice@symmetrysurgical.com

ONLINE

symmetrysurgical.com

MAILING ADDRESS

Symmetry Surgical
Attn: Customer Service
3034 Owen Drive
Antioch, TN 37013

The Surgical Instrument Desk Reference

International Customer Service

PHONE

Symmetry Surgical Switzerland GmbH
+41 (0) 52 557 59 00
(Available Monday through Friday, 7:00-16:00 GMT)

Symmetry Surgical, Inc., USA
1.615.964.5672
(Available Monday through Friday, 8:30 AM-6:30 PM EST)

FAX

Symmetry Surgical Switzerland GmbH
+41 (0) 52 557 59 99

EMAIL

customerservice@symmetrysurgical.com
internationalorders@symmetrysurgical.com

ONLINE

symmetrysurgical.com

MAILING ADDRESS

Symmetry Surgical Switzerland GmbH
Bühlstrasse 27
CH-8200 Schaffhausen
Switzerland

Symmetry Surgical, Inc.
3034 Owen Drive
Antioch, TN 37013

INTERNATIONAL PAYMENT TERMS/RETURN GOODS POLICY/INSTRUMENT REPAIR & RESTORE PROGRAM/LITERATURE REQUESTS

Please contact your local distributor. Locate a local distributor contact, International Customer Service at +41 (0) 52 557 59 00 or 1.615.964.5672 (US).

Cardiovascular/Thoracic

Energy

Ear, Nose & Throat

General

Laparoscopic

Neurology

Obesity

OB/GYN

Ophthalmology

Orthopedics & Arthroscopy

Pediatrics

Rectal

Retractors

Spine

Urology

Sterilization Solutions

Alphabetical & Numeric Indexes

Blades

Corneal Trephine Blades

CODE	DESCRIPTION	DIAMETER
60-4080	Short	8.0 mm
60-4175	Long	7.5 mm
60-4177	Long	7.75 mm



60-4080

Calipers

Castroviejo Caliper

CODE	DESCRIPTION	LENGTH
60-1931	0–20 mm Scale	3½ in 9.0 cm
60-1932	Curved Shaft	3½ in 9.0 cm



60-1931

Jameson Caliper

CODE	DESCRIPTION	LENGTH
60-1934	Caliper	4 in 10 cm



Townley Calipers

CODE	DESCRIPTION	LENGTH
60-1936	Working Length	4 in 10 cm



Cannulas

Air Injection Cannula

CODE	DESCRIPTION	GAUGE
60-1148	5.0 mm	27 G
60-1149	5.0 mm	30 G

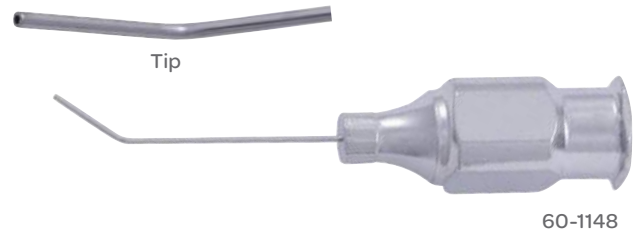

Atkinson Retrobulbar Needle

CODE	DESCRIPTION	GAUGE
60-1225	Sharp Rounded Point	23 G
60-1226	Sharp Rounded Point	25 G

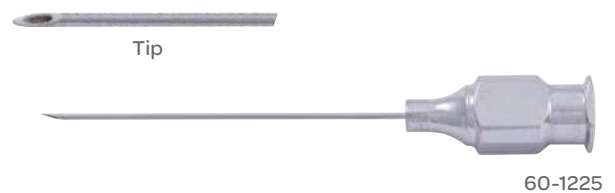

Binkhorst Irrigating Cannula

CODE	DESCRIPTION	GAUGE
60-1229	Straight, Smooth Blunt Tip, Front Opening	22 G



Bishop Harmon Irrigating Cannula

CODE	DESCRIPTION	GAUGE
60-1186	Silicone Bulb, Includes 60-1192, 60-1187 and 60-1193	
60-1187	Irrigating Cannula	19 G
60-1192	Adapter for Irrigator	19 G
60-1193	Silicone Bulb	19 G

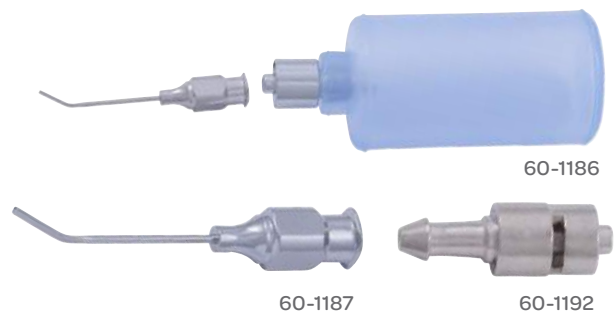

Cannulas

Bracken Anterior Chamber Cannula

CODE	DESCRIPTION	GAUGE	LENGTH
60-1189	Blunt	27 G	$\frac{3}{4}$ in 2.0 cm

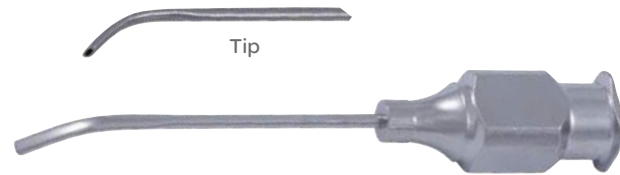

Gills-Welsh Irrigating Cannula

CODE	DESCRIPTION	GAUGE
60-1198	Angled, 5.0 mm	25 G
60-1201	Angled, 10 mm	25 G

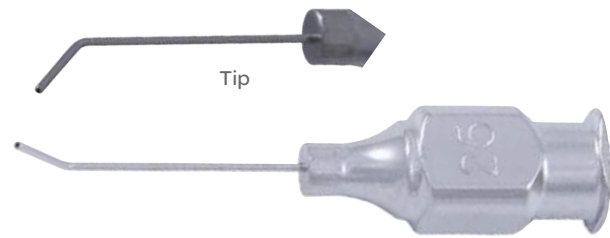

60-1198

Gills-Welsh Olive Tip Cannula

CODE	DESCRIPTION	GAUGE
60-1180	Angled 45°	25 G

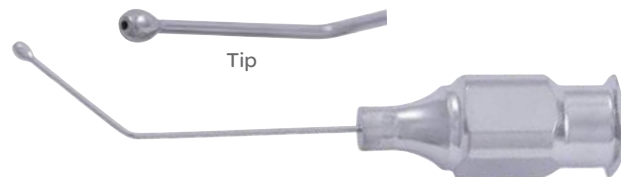

Gimbel Irrigating Cannula

CODE	DESCRIPTION
60-0226	26 French



Cannulas

Healon Injection Cannula

CODE	DESCRIPTION	GAUGE	LENGTH
60-1227	Flat Tip	21 G	1¼ in 3.0 cm



Jenson Capsule Polisher

CODE	DESCRIPTION	GAUGE
60-1147	Front Port, Diamond Dust Tip	27 G



Kelman Cyclodialysis Cannula

CODE	DESCRIPTION	GAUGE
60-1086	Port on Left Side	19 G



Kellan Hydrodissection Cannula

CODE	DESCRIPTION	GAUGE	LENGTH
60-1216	Curved, Vertical Flat Tip	25 G	¼ in 2.0 cm



Cannulas

Kratz Capsule Scraper

CODE	DESCRIPTION	GAUGE
60-1131	Sandblasted, Angled 30°, 1.0 mm Tip	22 G

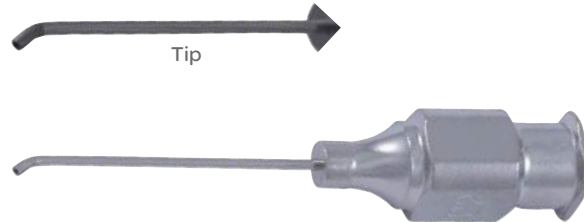

Kratz Lens Manipulator Cannula

CODE	DESCRIPTION	GAUGE
60-1130	Manipulator Cannula	30 G

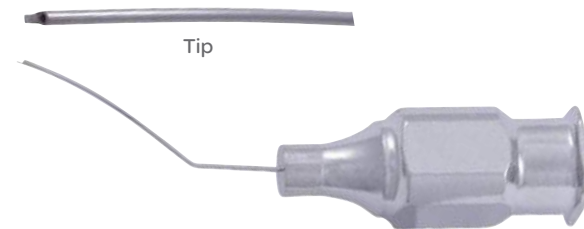

Lacrimal Cannula

CODE	DESCRIPTION	GAUGE	LENGTH
60-1211	Straight	23 G	1½ in 3.5 cm

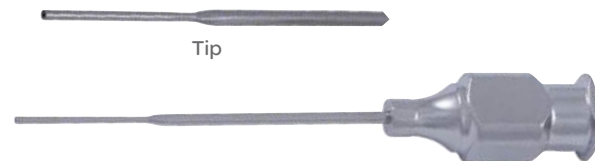

Cannulas

McIntyre Anterior Chamber Cannula

CODE	DESCRIPTION	GAUGE
60-1154	Straight	23 G
60-1156	Straight	26 G
60-1158	Straight	30 G
60-1157	Angled	26 G
60-1159	Angled	30 G



McIntyre-Binkhorst Irrigating Cannula

CODE	DESCRIPTION	GAUGE
60-1235	Right, Smooth Blunt Tip, Front Opening	26 G



Randolph Cyclodialysis Cannula

CODE	DESCRIPTION	GAUGE
60-1087	2.0 mm Tip	19 G



Scheie Anterior Chamber Cannula

CODE	DESCRIPTION	GAUGE	LENGTH
60-1188	Blunt	27 G	$\frac{3}{4}$ in 2.0 cm



Troutman Alpha-Chymotrypsin Cannula

CODE	DESCRIPTION	GAUGE
60-1179	Bulb Tip	25 G



Clamps

Serrefine

CODE	DESCRIPTION	LENGTH
60-2026	Straight	1½ in 3.5 cm
60-2027	Curved	1½ in 3.5 cm



60-2026

Curettes

Heath Chalazion Curette

CODE	DESCRIPTION	LENGTH
60-1428	#1 1.0 mm	5 in 12.5 cm
60-1429	#2 2.0 mm	5 in 12.5 cm
60-1430	#3 3.0 mm	5 in 12.5 cm



60-1428

Kraff Capsule Polishing Curette

CODE	DESCRIPTION	GAUGE
60-1260	1.75 mm Cup	25 G

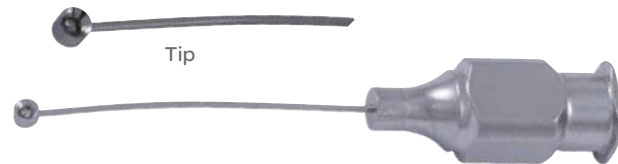

Meyerhoeffer Curette

CODE	DESCRIPTION	LENGTH
60-1421	#0 1.5 mm	5¼ in 13.5 cm
60-1422	#1 1.7 mm	5¼ in 13.5 cm
60-1423	#2 2.0 mm	5¼ in 13.5 cm
60-1424	#3 2.5 mm	5¼ in 13.5 cm
60-1425	#4 3.5 mm	5¼ in 13.5 cm



60-1421

Nightingale Capsule Polishing Curette

CODE	DESCRIPTION
60-1432	1.7 mm Diameter, Open Ring, Semi-Sharp



Depressors

Flynn Scleral Depressor

CODE	DESCRIPTION	LENGTH
60-2009	Lens Loop Style	3 1/8 in 8.0 cm



O'Connor Scleral Depressor-Marker

CODE	DESCRIPTION	LENGTH
60-2012	3.0 mm Teardrop on One End, 1.5 mm Gass Marker on Other End	5 1/8 in 13 cm



Schepens Scleral Depressor

CODE	DESCRIPTION
60-2000	Small, 16 mm Wide Bar



Shocket Scleral Depressor

Double-Ended, Teardrop-Shaped Tip

CODE	DESCRIPTION	LENGTH
60-2010	6.0mm Wide Bar, Pocket Clip, Small Thimble	5 1/8 in 13 cm



Urretts-Zavalía Depressor Pick

CODE	DESCRIPTION
60-2011	Triangular Tip



Dilators

Castroviejo Lacrimal Dilator

CODE	DESCRIPTION	LENGTH
60-1991	Double-Ended	5 in 12.5 cm



Ruedemann Lacrimal Dilator

CODE	DESCRIPTION
60-1996	Short



Wilder Lacrimal Dilator

CODE	DESCRIPTION	LENGTH
60-1993	Short	4 in 10 cm
60-1994	Medium	4 in 10 cm
60-1995	Long	4 in 10 cm

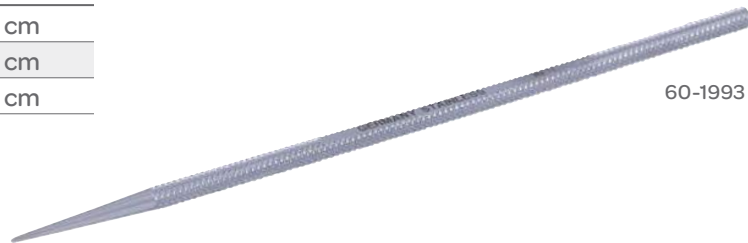

Simcoe Cortex Extractor

CODE	DESCRIPTION	GAUGE	LENGTH
60-1203	Extractor	23 G	½ in 1.27 cm



Forceps

Anis Lens Holding Forceps

CODE	DESCRIPTION	TIP SIZE
60-1730	45° Angle	0.5 mm

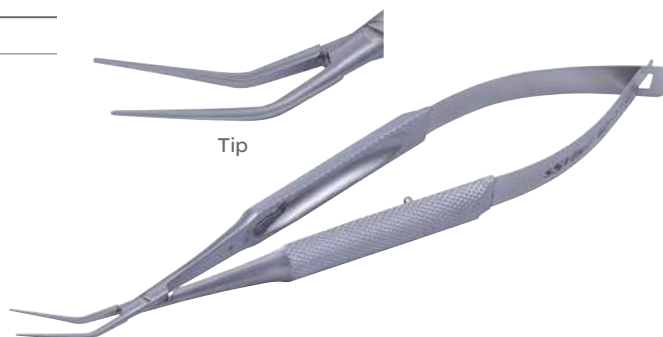

Baird Chalazion Forceps

Locking Thumb Screw

CODE	DESCRIPTION	LENGTH
60-1717	Open Blade 8.0 x 12 mm	3½ in 9.0 cm



Barraquer Cilia Forceps

CODE	DESCRIPTION	LENGTH
60-1699	Slightly Curved Jaws, with Platform	4¼ in 10.8 cm

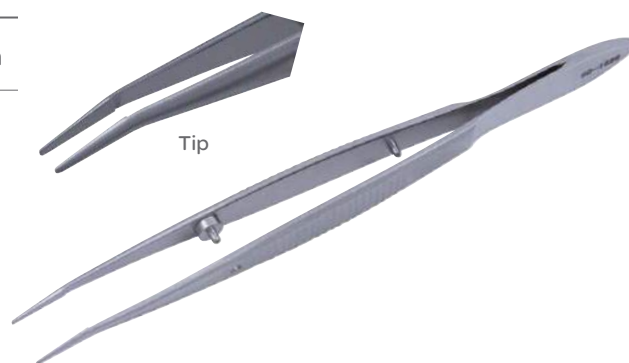

Bechert-McPherson Tying Forceps

10 mm, Tying Platform

CODE	DESCRIPTION	LENGTH
60-1578	Angled, Smooth Jaws	3⅞ in 8.0 cm



Forceps

Berke Ptosis Forceps

Serrated Blades, Slide Lock

CODE	DESCRIPTION	LENGTH	
60-1669	20 mm Blades	4 in	10 cm
60-1670	27 mm Blades	4 in	10 cm



60-1669

Binkhorst Lens Forceps

CODE	DESCRIPTION
60-1736	Cross Action



Bishop Harmon Tissue Forceps

CODE	DESCRIPTION	TEETH	LENGTH	
60-1522	Standard	1x2	3 3/8 in	8.57 cm
60-1523	Extra Delicate, Straight	1x2	3 3/8 in	8.57 cm
60-1524	Cross-Serrated Tips	None	3 3/8 in	8.57 cm



60-1522

Blaydes Lens Holding Forceps

Narrow, Smooth Jaws

CODE	DESCRIPTION	LENGTH	
60-1739	Angled 45°, Very Delicate	4 1/2 in	11.5 cm

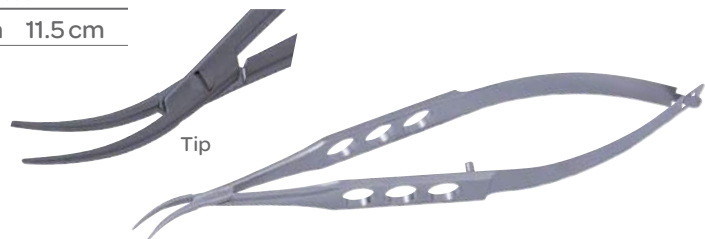

Forceps

Bonn Suture Forceps

Without Platform, Extra Delicate

CODE	TEETH	LENGTH
60-1641	0.12 mm	3 in 7.5 cm



Bonn Suture Forceps

With Platform, Extra Delicate

CODE	TEETH	LENGTH
60-1660	0.12 mm	3 3/4 in 9.5 cm



Bonaccolto Utility Forceps

Cross-Serrated Tip, Rear of Jaw Fluted

CODE	TIPS	LENGTH
60-1677	1.2 mm	4 1/8 in 10.5 cm



Botvin Iris Forceps

CODE	TEETH	LENGTH
60-1512	1x2	3 in 7.5 cm



Bracken Iris Forceps

Cross-Serrated Tips

CODE	DESCRIPTION	LENGTH
60-1506	Curved	3 9/10 in 9.90 cm



Forceps

Castroviejo Fixation Forceps

Wide Handle, without Platform, 1 x 2 Teeth

CODE	DESCRIPTION	LENGTH
60-1547	0.3 mm Teeth	4 ¼ in 10.8 cm
60-1548	0.5 mm Teeth	4 ¼ in 10.8 cm



60-1547

Castroviejo Titanium Suture Forceps

CODE	DESCRIPTION	LENGTH
60-1631T	Straight Jaw, 0.3 mm Teeth	4 ½ in 11.5 cm
60-1632T	Straight Jaw, 0.5 mm Teeth	4 ½ in 11.5 cm



60-1632T

Castroviejo Suture Forceps

Wide Handle with Platform

CODE	DESCRIPTION	TEETH	LENGTH
60-1629	Teeth on Straight Shaft	0.12 mm	4 ¼ in 10.8 cm
60-1631	Teeth on Straight Shaft	0.3 mm	4 ¼ in 10.8 cm
60-1632	Teeth on Straight Shaft	0.5 mm	4 ¼ in 10.8 cm
60-1637	Teeth on Straight Shaft	0.9 mm	4 ¼ in 10.8 cm
60-1634	Teeth on Straight Shaft	1.5 mm	4 ¼ in 10.8 cm
60-1630	Teeth on Angled Shaft	0.12 mm	4 ⅛ in 10.5 cm
60-1628	Teeth on Angled Shaft	0.3 mm	4 ⅛ in 10.5 cm
60-1627	Teeth on Angled Shaft	0.5 mm	4 ⅛ in 10.5 cm



60-1629

Castroviejo Suture Forceps

CODE	DESCRIPTION	LENGTH
60-1638	Castroviejo 0.12 mm 1 x 2 Teeth with Platform	4 ¼ in 10.8 cm
60-1639	Castroviejo 0.3 mm 1 x 2 Teeth with Platform	4 ¼ in 10.8 cm
60-1635	Castroviejo 0.5 mm 1 x 2 Teeth with Platform	4 ¼ in 10.8 cm



60-1638

Forceps

Colibri Titanium Forceps

CODE	DESCRIPTION	LENGTH
60-5315	Angled Tips	3½ in 8.5 cm

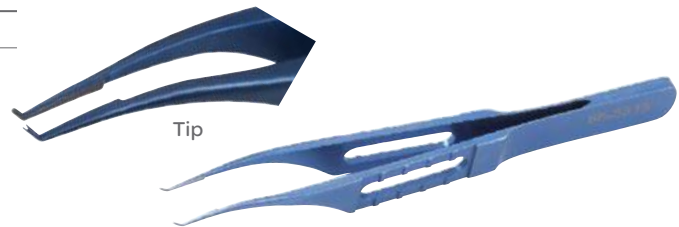

Colibri Tying Forceps

6.0 mm, Tying Platform

CODE	DESCRIPTION	LENGTH
60-1467	6.0 mm with Platform, 0.12 mm, Angled 45°	4⅛ in 10.5 cm

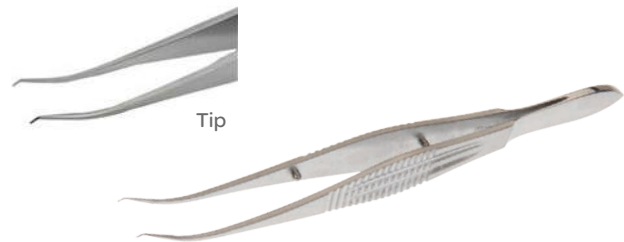

Desmarres Chalazion Forceps

Locking Thumb Screw, Smooth Blade

CODE	DESCRIPTION	LENGTH
60-1711	Small	3½ in 9.0 cm
60-1718	Medium	3½ in 9.0 cm

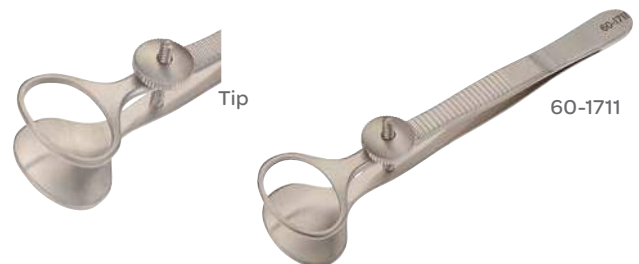

Dodick Nucleus Splitter

CODE	DESCRIPTION	LENGTH
60-1583	Serrated Paddle Jaws	4⅛ in 10.5 cm



Drews Cilia Forceps

CODE	DESCRIPTION	LENGTH
60-1701	4.0 mm Tips	4⅛ in 10.5 cm



Forceps

Ehrhardt Lid Forceps

Straight 9.0 mm Serrated Upper Jaw

CODE	DESCRIPTION	LENGTH
60-5530	14 mm Oval Lower Plate	4 in 10 cm

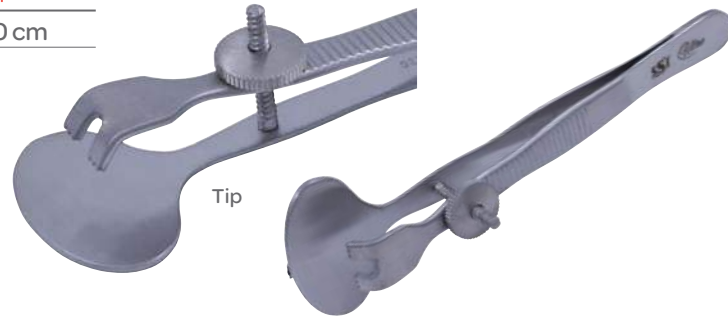

Elschnig Fixation Forceps

CODE	DESCRIPTION	LENGTH
60-1541	Heavy, 1 x 2 Angled Teeth	4 1/4 in 10.8 cm



Elschnig Fixation Forceps

CODE	DESCRIPTION	LENGTH
60-1542	1 x 2 Teeth with Catch	4 3/8 in 11.11 cm



Francis Chalazion Forceps

Inside Dimensions, 12 x 14 mm Long, Locking Thumb Screw

CODE	DESCRIPTION	LENGTH
60-1712	Smooth Blade	3 3/4 in 9.52 cm



Forceps

Gills Iris Forceps

Slightly Curved

CODE	DESCRIPTION	LENGTH
60-1510	1 x 2 Teeth	2¾ in 7.0 cm
60-1511	Cross-Serrated Tips	2¾ in 7.0 cm



60-1510

Gills-Welsh Capsule Forceps

CODE	DESCRIPTION	LENGTH
60-1496	Smooth Tips	2¾ in 7.0 cm

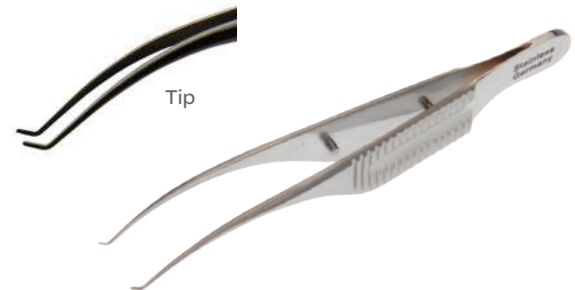

Girard Corneo-Scleral Forceps

Tying Platform

CODE	DESCRIPTION	LENGTH
60-1453	0.5 mm, Smooth Tips	4⅛ in 10.5 cm
60-1653	0.12 mm, 1 x 2 Teeth	4⅛ in 10.5 cm



60-1453

Girard Forceps

Round Handle

CODE	DESCRIPTION	LENGTH
60-1456	0.12 Left Hand	4¼ in 10.8 cm
60-1458	0.12 Right Hand	4¼ in 10.8 cm



60-1456

Graefe Fixation Forceps

CODE	DESCRIPTION	LENGTH
60-1530	4.5 mm Jaw with Lock	4⅛ in 10.5 cm



Forceps

Graefe Iris Forceps

CODE	DESCRIPTION	LENGTH
60-1515	1x2 Teeth	2½ in 6.5 cm
60-1517	Straight Cross-Serrated Tips	2½ in 6.5 cm
60-1516	Curved Cross-Serrated Tips	2½ in 6.5 cm

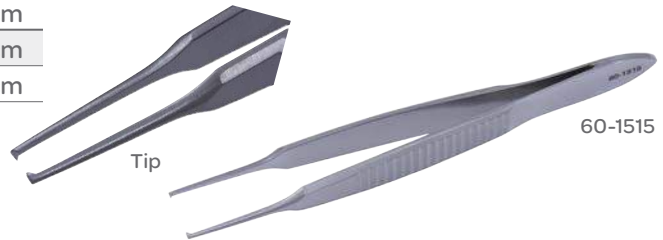

Harms-Tubingen Tying Forceps

CODE	DESCRIPTION	LENGTH
60-1612	Straight	4⅛ in 10.5 cm



Harms Utility Forceps

CODE	DESCRIPTION	LENGTH
60-1465	1x2 Teeth	3 in 7.5 cm

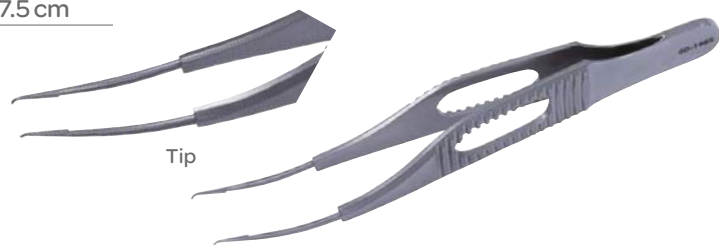

Hunt Chalazion Forceps

Open Smooth Blade, Locking Thumb Screw

CODE	DESCRIPTION
60-1714	12 mm Blade



Forceps

Jaffe-Castroviejo Suture Forceps

1 x 2 Teeth with Platform

CODE	DESCRIPTION	LENGTH
60-1621	0.12 mm	4 ¼ in 10.8 cm



Jaffe Tying Forceps

Very Delicate, Smooth Jaws, with Platform

CODE	DESCRIPTION	LENGTH
60-1608	Straight	4 in 10 cm
60-1609	Curved	4 in 10 cm



Jameson Muscle Forceps

12.0 mm Jaw, Slide Lock

CODE	DESCRIPTION	LENGTH
60-1664	Left	4 in 10 cm
60-1665	Right	4 in 10 cm

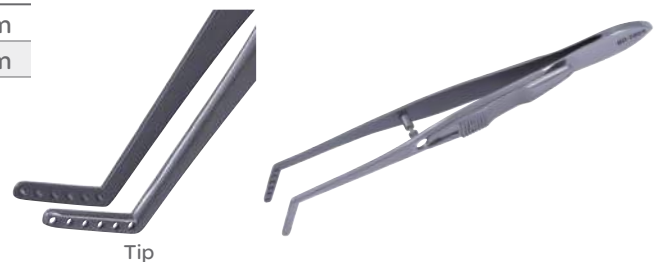

Jewelers Forceps

CODE	DESCRIPTION	STYLE	LENGTH
60-1683	With Tying Platform		4 ¾ in 12 cm
60-1689	Fine Point	Style 1	4 ¾ in 12 cm
60-1691	Straight, Extra Fine Point	Style 3	4 ¾ in 11.1 cm
60-1692	Straight, Extra Fine Point	Style 4	4 ¾ in 11.1 cm
60-1693	Straight, Extra Fine Point	Style 5	4 ¾ in 11.1 cm
60-1690	Straight, Extra Fine Point	Style 3	4 ½ in 11.5 cm
60-1695	Angled, Extra Fine Point	Style 5	4 ¾ in 11.1 cm
60-1694	Curved, Extra Fine Point	Style 7	4 ¾ in 11.1 cm



Forceps

Kelman-McPherson Tying Forceps

Smooth Jaws, 7.5 mm Tying Platform

CODE	DESCRIPTION	LENGTH
60-1579	Angled	3 1/8 in 8.0 cm
60-1580	Angled, Very Delicate	3 3/4 in 9.5 cm



Kraff Capsule Tag Forceps

1.5 mm Smooth Platform

CODE	DESCRIPTION	LENGTH
60-1490	11 mm Angled Jaws	4 in 10 cm



Kratz Lens Holding Forceps

Very Delicate Narrow Jaws, Smooth, Slightly Curved

CODE	DESCRIPTION	LENGTH
60-1727	Without Lock	4 1/2 in 11.5 cm



Kremer Fixation Forceps

CODE	DESCRIPTION
60-1552	Angled with Lock



Lambert Chalazion Forceps

CODE	DESCRIPTION	LENGTH
60-1716	Large, 12 mm Opening	3 1/2 in 9.0 cm



Forceps

Lehner-Utrata Capsulorhexis Forceps

CODE	DESCRIPTION	LENGTH
60-1494	Flat Handle, Vaulted Shafts	4 in 10 cm



Lester Fixation Forceps

CODE	TEETH	LENGTH
60-1534	1x2	3 3/4 in 9.5 cm
60-1535	2x3	3 3/4 in 9.5 cm



Maumenee Corneal Forceps

CODE	DESCRIPTION	LENGTH
60-1470	90° Angle	4 3/4 in 12 cm



McCullough Utility Forceps

CODE	DESCRIPTION	LENGTH
60-1680	Smooth Jaws	3 3/4 in 9.5 cm



Masket Capsulorhexis Forceps

CODE	JAWS	LENGTH
60-1553	11 mm	4 1/4 in 10.8 cm



Forceps

McPherson Tying Forceps

CODE	DESCRIPTION	LENGTH
60-1596	Straight	3 1/8 in 8.0 cm
60-1592	Angled	3 1/8 in 8.0 cm



60-1592

Nugent Utility Forceps

10 mm Jaws, Angled 45°

CODE	DESCRIPTION	LENGTH
60-1673	Smooth Jaws	4 1/8 in 10.5 cm
60-1674	Serrated Jaws	4 1/8 in 10.5 cm



60-1673

O'Gawa Tying Forceps

CODE	DESCRIPTION	LENGTH
60-1590	5.5 mm Platform	4 1/4 in 10.8 cm



Tip

O'Gawa Tying Forceps

Smooth, 0.5 mm Platform, 0.3 mm Gap at Heel of Platform

CODE	DESCRIPTION	LENGTH
60-1605	Straight	4 1/2 in 11.5 cm
60-1606	Curved	4 1/2 in 11.5 cm

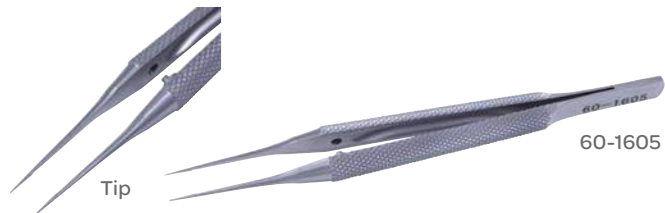

Tip

60-1605

Paufique Forceps

CODE	DESCRIPTION	LENGTH
60-1651	1 x 2 Strong Teeth, with Platform	3 1/2 in 9.0 cm



Tip

Forceps

Sauer Suture Forceps

CODE	DESCRIPTION	LENGTH
60-1650	1 x 2 Teeth at Oblique Angled To Shaft	3½ in 9.0 cm



Schaff Foreign Body Forceps

CODE	DESCRIPTION	LENGTH
60-1696	Grooved Jaw	4¼ in 10.5 cm



Sheets-McPherson Tying Forceps

CODE	DESCRIPTION	LENGTH
60-1577	Angled, 10 mm Tying Platform, Cross-Serrated Tips	3⅞ in 8.0 cm



Sinsky Tying Forceps

CODE	DESCRIPTION	LENGTH
60-1598	Straight, Micro Tip with 7.0 mm Tying Platform	4¼ in 10.8 cm



Stern-Castroviejo Forceps

With Lock

CODE	DESCRIPTION	LENGTH
60-1633	Straight, 0.5 mm Teeth with Platform	4¾ in 11.1 cm



Forceps

Suture Tying Forceps

Round Handle

CODE	DESCRIPTION	LENGTH
60-1352	Straight	4 ³ / ₄ in 12 cm
60-1353	Curved	4 ³ / ₄ in 12 cm



60-1352

Utrata Titanium Capsulorhexis Forceps

CODE	DESCRIPTION	LENGTH
60-5150	Flat Handle	4 in 10 cm

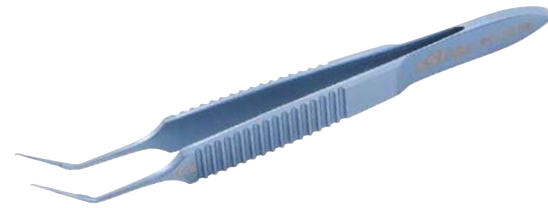

Titanium Nordan Tying Forceps

CODE	DESCRIPTION	LENGTH
60-5340	Straight	4 ¹ / ₂ in 11.5 cm
60-5342	Curved	4 ¹ / ₂ in 11.5 cm



60-5340

Titanium Tying Forceps

Flat Handle, Straight

CODE	DESCRIPTION	LENGTH
60-9201T	7.0 mm Platform	4 ¹ / ₂ in 11.5 cm



Tip

Thorpe Conjunctival Fixation Forceps

2 x 3 Teeth with Platform

CODE	TEETH	LENGTH
60-1544	0.6 mm	3 ³ / ₄ in 9.5 cm



Tip

Forceps

Titanium Capsulorhexis Utrata Forceps

CODE	DESCRIPTION
60-5149	Flat Handle

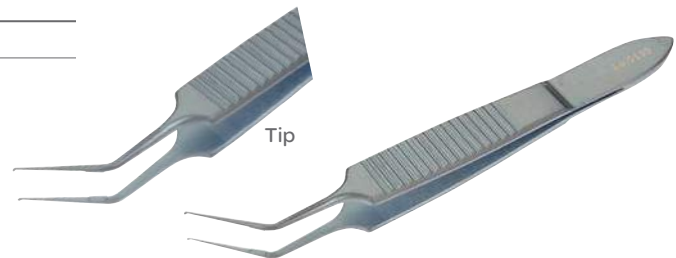

Tennant Tying Forceps

6.0 mm, Smooth Platform

CODE	DESCRIPTION	LENGTH
60-1619	Straight	4 in 10 cm
60-1618	Curved	4 in 10 cm



Titanium Tennant Tying Forceps

With Guide Pin and Platform

CODE	DESCRIPTION	LENGTH
60-5325	Straight	4 in 10 cm
60-5326	Curved	4 in 10 cm

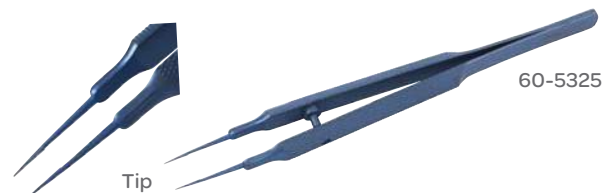

Troutman-Barraquer Corneal Utility Forceps

0.12 mm Teeth

CODE	DESCRIPTION	LENGTH
60-1462	With Platform, Very Delicate	3 in 7.5 cm
60-1463	Without Platform	3 in 7.5 cm



Watzke Sleeve Spreading Forceps

Angled 30°

CODE	DESCRIPTION	LENGTH
60-1732	Serrated 10 mm Tips	4 ½ in 11.5 cm



Forceps

Wills Hospital Utility Forceps

CODE	DESCRIPTION	LENGTH
60-1675	13 mm Platform With Cross-Serrations	4 1/8 in 10.5 cm



Ultra™ Titanium Tying Forceps

CODE	DESCRIPTION	LENGTH
60-5400	Straight, with Tying Platform	3 3/8 in 8.57 cm



University Of Kansas Corneal Forceps

Colibri Style 2 x 2 Teeth, 7.0 mm Tying Platform

CODE	DESCRIPTION	LENGTH
60-1471	0.12 mm Teeth, Angled 45°	4 1/8 in 10.5 cm



Utrata Capsulorhexis Forceps

12 mm, Long Angled Jaws with Iris Stop

CODE	DESCRIPTION	LENGTH
60-1499	Round Handle, Extra Delicate 0.5 mm Pad at Distal Tips	4 1/4 in 10.8 cm
60-1492	Flat Handle	4 1/4 in 10.8 cm



Utrata Capsulorhexis Forceps

CODE	DESCRIPTION	LENGTH
60-1492S	Forceps	3 1/2 in 9.0 cm



Gauges

Mendez Degree Gauge

CODE	DESCRIPTION
60-7086	12 mm Inner Diameter



Hooks

Bonn Iris Hook

CODE	DESCRIPTION	LENGTH
60-1324	Curved, 3.0 mm Hook	5 in 12.5 cm



Bechert Lens Nucleus Rotator

CODE	DESCRIPTION	LENGTH
60-1118	Fork on Front	5 in 12.5 cm



Committed to Customer Service

Symmetry Surgical's Customer Service team of professionals is dedicated to providing our customers with world-class support, service and expertise. We strive to meet and exceed all expectations – and we consider our customers to be part of our extended family. Each team member has multi-faceted roles and is trained to answer questions about each of our diverse product lines.

Hooks

Clayman Iris Hook

CODE	DESCRIPTION	LENGTH
60-1319	Angled 45°, 9.0 mm from Tip to Angle	4 1/8 in 10.5 cm



Clayman-Jaffe Lens Manipulating Hook

CODE	DESCRIPTION	LENGTH
60-1309	Angled 45°, 9.0 mm Shaft with 0.2 mm Hook	4 3/4 in 12 cm



Crawford (Benger) Retrieving Hook

CODE	DESCRIPTION
60-1988	Retrieving Hook



Connor Wand

CODE	DESCRIPTION	LENGTH
60-2328	Straight	4 1/2 in 11.5 cm
60-1328	Angled	4 1/2 in 11.5 cm

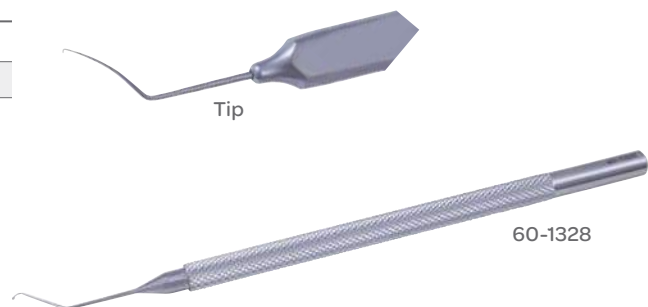

Hooks

Double Fixation Hook

CODE	DESCRIPTION	LENGTH
60-1298	1.5 mm Between Tips	5 1/8 in 13 cm
60-1299	2.0 mm Between Tips	5 1/8 in 13 cm

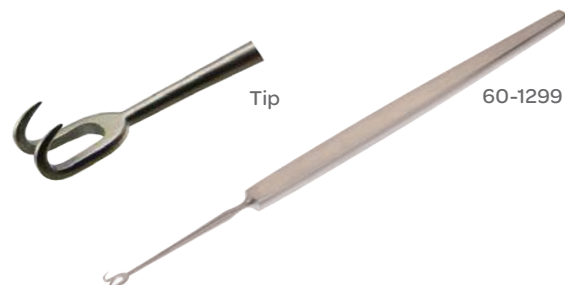

Galand Lens Manipulating Hook

CODE	DESCRIPTION
60-1123	Angled

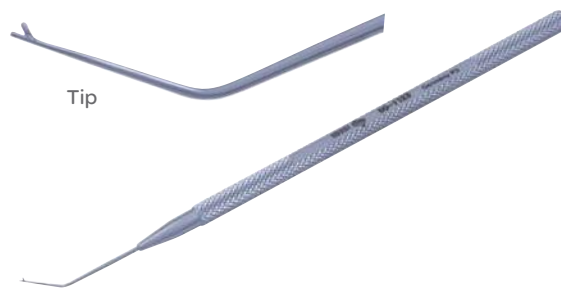

Gass Retinal Detachment Hook

CODE	DESCRIPTION	LENGTH
60-4991	Retinal Detachment Hook	5 3/4 in 14.5 cm

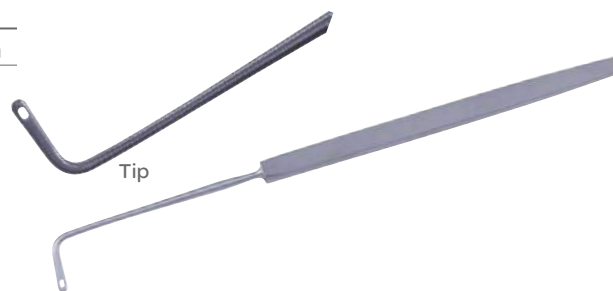

Hirschman Iris Hook

CODE	DESCRIPTION	LENGTH
60-1326	Angled, 0.75 mm Hook	4 3/4 in 12 cm



Hooks

Jameson Muscle Hook

CODE	DESCRIPTION	LENGTH
60-1340	Small	5 1/8 in 13 cm
60-1339	Large	5 1/8 in 13 cm

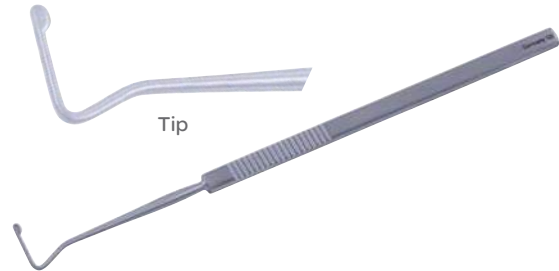

Leiske-Smith Lens Pusher

CODE	DESCRIPTION	LENGTH
60-1128	U-Shaped Tip	4 1/2 in 11.5 cm



Lester Hook

CODE	DESCRIPTION
60-1334	Modified

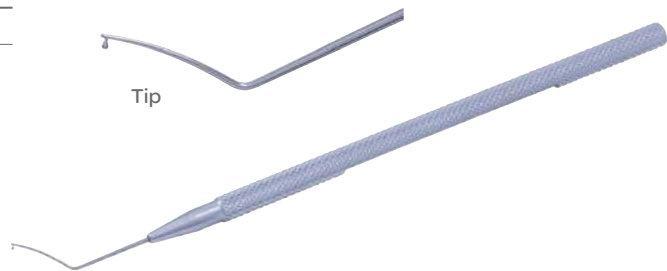

Lester Lens Pusher

0.25 mm Diameter, Hourglass Tip

CODE	DESCRIPTION	LENGTH
60-1126	Straight	4 1/2 in 11.5 cm
60-1127	Angled	4 1/2 in 11.5 cm



Hooks

Lewicky Lens Manipulating Hook

CODE	DESCRIPTION	LENGTH
60-1306	Curved, 9.0 mm Shaft, 90° Angled, 2.0 mm Tip	4½ in 11.5 cm



Maltzman-Fenzl Lens Manipulating Hook

CODE	DESCRIPTION	LENGTH
60-1311	Angled, 0.15 mm V-Shaped Tip	4¾ in 12 cm

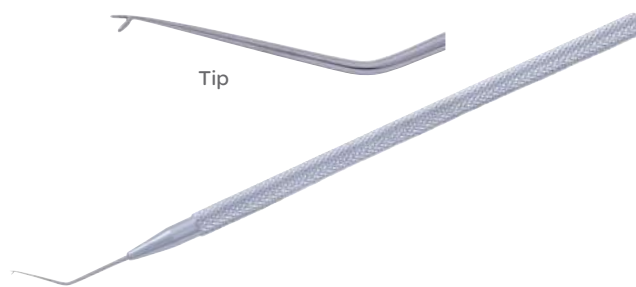

Manson Double Hook

CODE	DESCRIPTION
60-1349	Double Hook

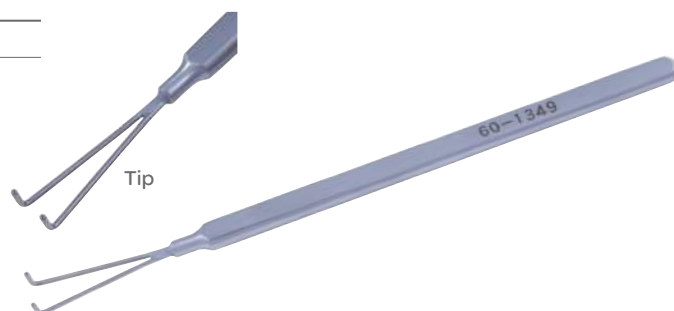

Nagahara Nucleus Chopper

CODE	DESCRIPTION	LENGTH
60-1114	Left	4½ in 11.5 cm
60-1115	Right	4½ in 11.5 cm

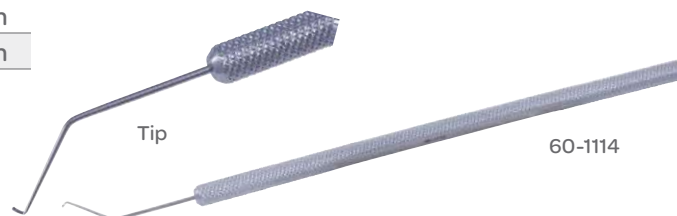

Hooks

Osher "Y" Hook

CODE	DESCRIPTION	LENGTH
60-1307	"Y" Hook	4 ³ / ₄ in 12 cm



Sinskey II Lens Manipulating Hook

0.25 mm Blunt Tip, Round Handle

CODE	DESCRIPTION	LENGTH
60-1363	Straight	4 ¹ / ₂ in 11.5 cm



Sinskey II Lens Manipulating Hook

0.2 mm Blunt Tip, Round Handle

CODE	DESCRIPTION	LENGTH
60-1366	Straight	4 ¹ / ₂ in 11.5 cm
60-1367	Angled	4 ¹ / ₂ in 11.5 cm



Sinskey Iris Lens Manipulating Hook

Blunt Tip, 2.0 mm Diameter

CODE	DESCRIPTION
60-1310	Straight
60-1310A	Angled

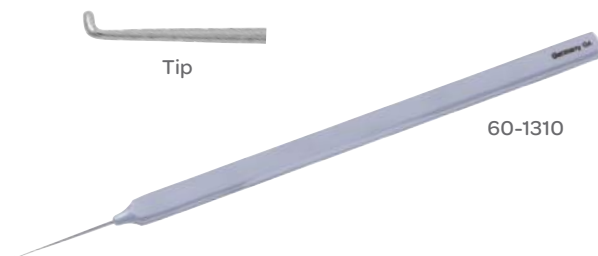

Hooks

Stevens Tenotomy Hook

CODE	DESCRIPTION	LENGTH
60-1348	6.0 mm Curved Hook	4 $\frac{3}{4}$ in 12 cm



Twist Fixation Hook

CODE	DESCRIPTION	LENGTH
60-1300	Right, 0.5 mm	4 $\frac{1}{4}$ in 10.8 cm

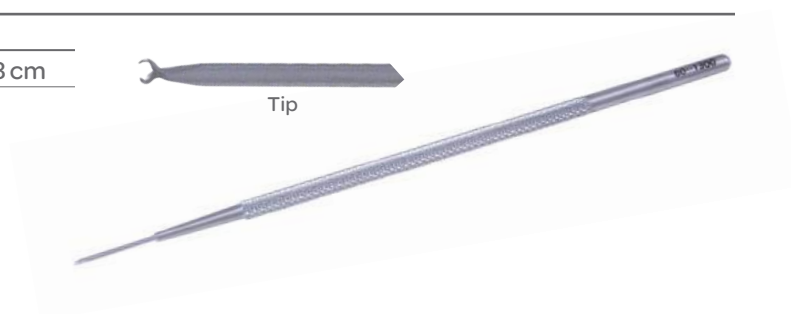

Sheets Iris Hook

CODE	DESCRIPTION	LENGTH
60-1327	3.0 mm Hook with Guard	5 $\frac{1}{8}$ in 13 cm

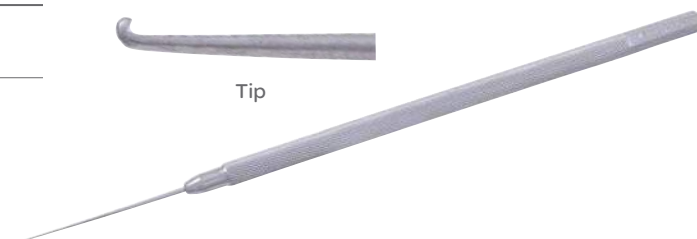

Titanium Kuglen Push/Pull Hook

CODE	DESCRIPTION
60-9516T	Push/Pull Hook



Von Graefe Strabismus Hook

CODE	DESCRIPTION	LENGTH
60-1344	#1, 1.0 x 5.0 mm	5 $\frac{1}{4}$ in 13.5 cm
60-1346	#3, 2.0 x 11 mm	5 $\frac{3}{4}$ in 14.5 cm



60-1344

Introducers

Fox Sphere Introducer

CODE	DESCRIPTION	LENGTH
60-3023	Sphere Introducer	4 ⁷ / ₈ in 12.4 cm



Intubation Sets

Catalano Intubation Set

CODE	DESCRIPTION
60-1992	Intubation Set

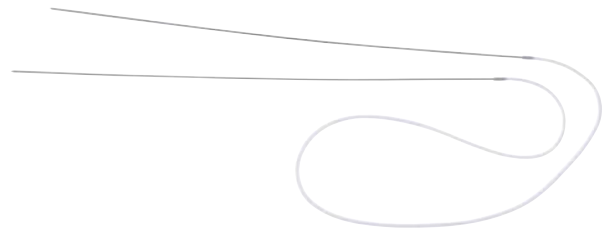

Crawford Lacrimal Intubation Set

CODE	DESCRIPTION
60-2014	Intubation Set

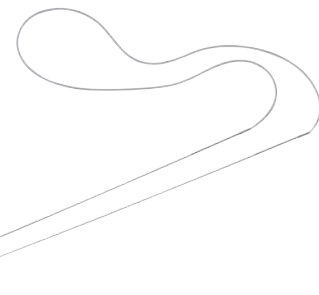

Jackson Lacrimal Intubation Set

CODE	DESCRIPTION
60-1990	Two 20-Gauge Thin Wall Probes (15.24) with 29.8 cm of Silicone Tubing Attached



Knives

Tooke Corneal Knife

CODE	DESCRIPTION	LENGTH
60-1045	Smooth, 3.0 x 18 mm Blade	4 ³ / ₄ in 12 cm



Lens Crackers

Titanium Salz Lens Cracker

CODE	DESCRIPTION
60-9155T	Splitter



Simplifying Global Business

Symmetry Surgical understands the global marketplace and has a dedicated international team, including international customer service representatives, international business specialists, and international sales specialists. We have local representation through a network of authorized distributors or direct sales representatives in practically every nation.

If you would like more information on authorized sales agents in your country, please send your inquiry to InternationalOrders@symmetrysurgical.com.

Our international team is dedicated to supporting and managing the business efforts of our global customers and distributors—providing service that exceeds expectations.



Loops

Gills-Welsh Lens Loop

CODE	DESCRIPTION
60-1278	Lens Loop



Kirby Intra-Capsular Lens Loop

CODE	DESCRIPTION	LENGTH
60-1285	Long, Slender Loop	5½ in 14 cm

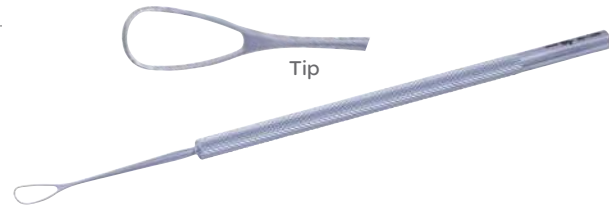

New Orleans Eye & Ear Lens Loop

CODE	DESCRIPTION	LENGTH
60-1281	Double-ended, 4.0 x 20 mm	5½ in 14 cm



Simcoe Lens Loop

CODE	DESCRIPTION	LENGTH
60-1280	Double-ended, Serrated Loops 4.0 x 15 x 20 mm	5½ in 14 cm



Wilder Lens Loop

CODE	DESCRIPTION	LENGTH
60-1275	Serrated, 4.0 x 15 mm Loop on Flat Handle	5½ in 14 cm



Manipulators

Drysdale Nucleus Manipulator

CODE	DESCRIPTION	LENGTH	
60-1119	Flattened Paddle Tip	4 in	10 cm

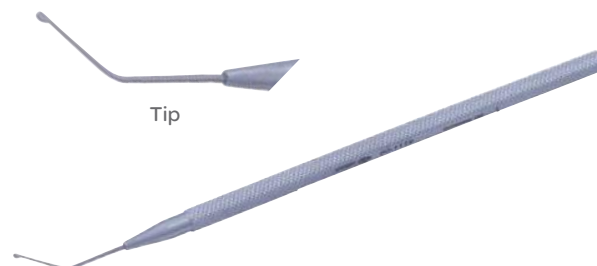

Bechert Lens Nucleus Rotator

CODE	DESCRIPTION	LENGTH	
60-1117	Angled, Blunt Forked Tip, 9.0 mm From Tip	4 ½ in	11.5 cm
60-1118	Fork on Front	5 in	12.5 cm

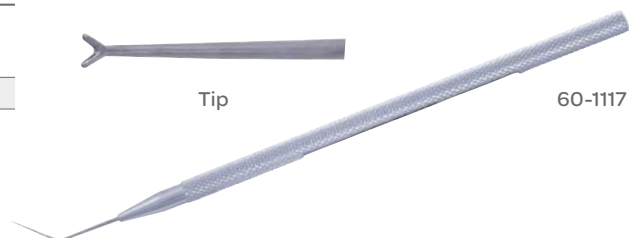

Jaffe-Maltzman Lens Manipulating Hook

CODE	DESCRIPTION	LENGTH	
60-1317	0.15 mm V-Shaped Angled Tip, Flat Handle	4 ¾ in	12 cm



Maloney No Hole IOL Manipulator

CODE	DESCRIPTION	LENGTH	
60-1333	Teardrop Shape Tip with Post	4 ¾ in	12 cm

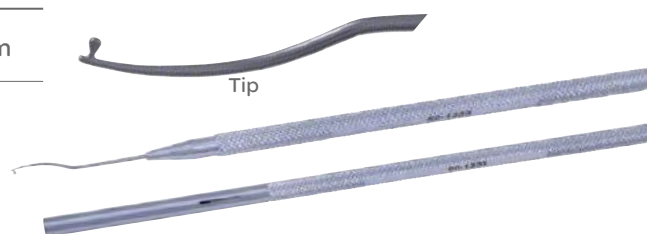

Manipulators

Harris-Sinskey Lens Manipulating Hook

CODE	DESCRIPTION	LENGTH
60-1369	Angled, 0.25 mm Diameter Blunt Tip	4 1/8 in 10.5 cm

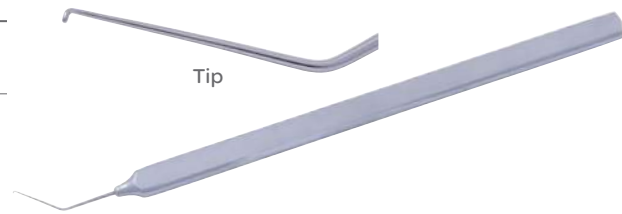

Osher Nucleus Manipulator

CODE	DESCRIPTION	LENGTH
60-1314	Blunt, Smaller than 60-1313, 0.5 mm, Two-Prong Tip	4 3/4 in 12 cm

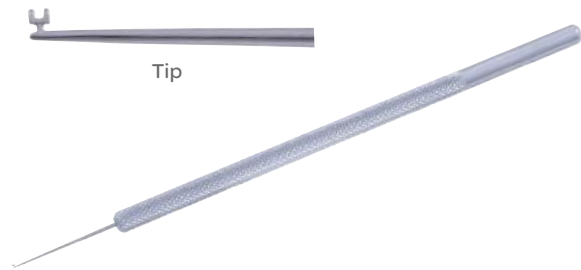

Tennant Nucleus Manipulator

CODE	DESCRIPTION	LENGTH
60-1125	Manipulator	4 3/4 in 12 cm

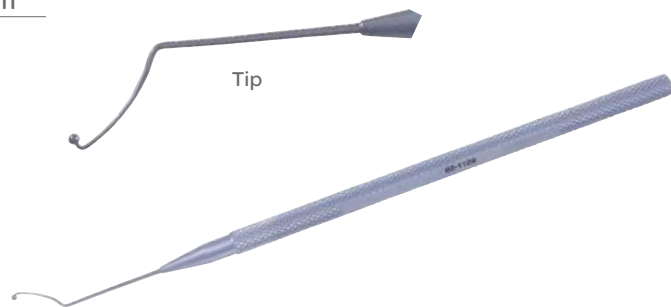

Markers

Bores Optic Zone Marker

CODE	DESCRIPTION	LENGTH	
60-7002	2.75 mm	3 ³ / ₄ in	9.5 cm
60-7010	4.75 mm	3 ³ / ₄ in	9.5 cm
60-7014	8.0 mm	3 ³ / ₄ in	9.5 cm



Bores Radial Marker

4.0 mm Center Opening, 9.5 mm Outer Diameter

CODE	DESCRIPTION
60-7051	6 Blades
60-7052	8 Blades



Osher-Neumann Corneal Marker

4 Blades

CODE	INNER DIAMETER	LENGTH	
60-8036	4.5 mm	4 ¹ / ₄ in	10.8 cm

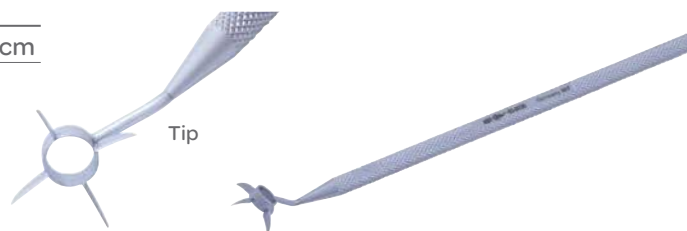

Thornton Optical Zone Marker

CODE	DESCRIPTION
60-7026	4 ³ / ₄ in 12 cm

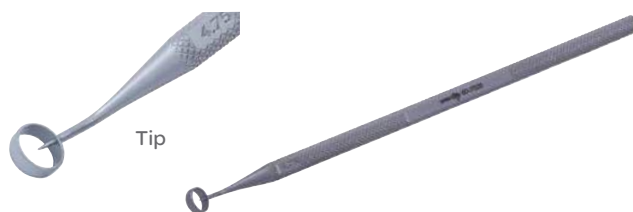

Needles

Dix Needle & Gouge

Complete Set

CODE	DESCRIPTION
60-1434	Reversible Screw Handle

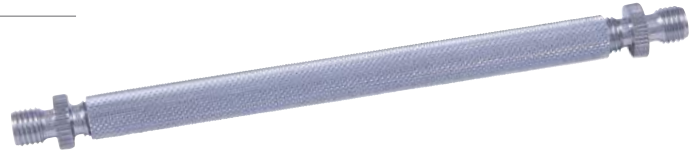

Maumenee Vitreous Aspirating Needle

CODE	DESCRIPTION
60-1151	Blunt Tip with Markings at 5.0 mm, 10 mm and 15 mm



Scheie Aspirating Cataract Needle

CODE	DESCRIPTION	GAUGE
60-1150	Sharp, Beveled Point	19 G

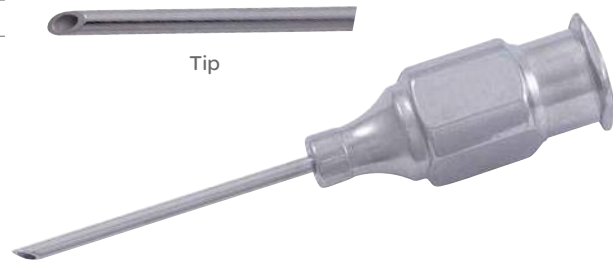

Wright Fascia Needle

CODE	DESCRIPTION
60-1018	Fascia Needle

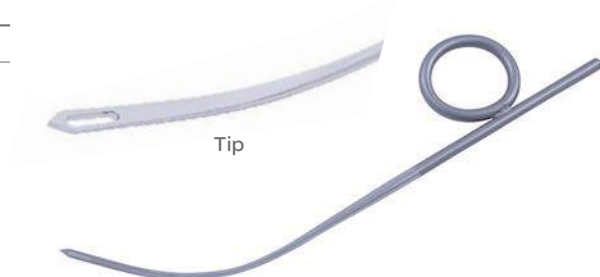

Needle Holders

Anis Needle Holder

Extra Delicate, 8.0 mm Jaws

CODE	DESCRIPTION	LENGTH
60-2801	Straight with Lock	5 in 12.5 cm
60-2803	Curved with Lock	5 in 12.5 cm



60-2801

Barraquer Needle Holder

Delicate Smooth Jaws, Round Handle

CODE	DESCRIPTION	LENGTH
60-1887	Straight with Lock	5 ¼ in 13.5 cm
60-1888	Straight without Lock	5 ¼ in 13.5 cm
60-1905	Straight with Lock, Delicate 8.0 mm Jaws	5 ¼ in 13.5 cm
60-1886	Curved without Lock	5 ¼ in 13.5 cm
60-1903	Curved without Lock, Delicate 8.0 mm Jaws	5 ¼ in 13.5 cm
60-1904	Curved with Lock, Delicate 8.0 mm Jaws	5 ¼ in 13.5 cm
60-1896	Curved without Lock, Delicate 10 mm Jaws	5 ¼ in 13.5 cm
60-1897	Curved with Lock, Delicate 10 mm Jaws	5 ¼ in 13.5 cm



Tip

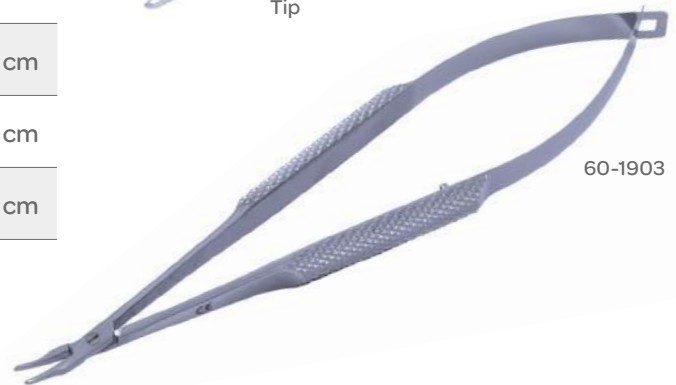

60-1903

Castroviejo Needle Holder

8.0 mm Wide Flat Handle, 10 mm Tips

CODE	DESCRIPTION	LENGTH
60-1910	Curved without Lock	5 ½ in 14 cm
60-1921	Straight without Lock	5 ½ in 14 cm



60-1910

Needle Holders

Castroviejo Needle Holder

CODE	DESCRIPTION	JAWS	LENGTH
60-1874	Straight with Lock, Round Handle	9.0 mm	4 ³ / ₄ in 12.0 cm
60-1918	Straight with Lock, Flat Wide Handle	Very Delicate 9.0 mm	5 ¹ / ₄ in 13.5 cm
60-1917	Straight with Lock, Flat Handle	Delicate 10 mm	5 ¹ / ₂ in 14 cm
60-1922	Straight with Lock, Flat Handle	14 mm	5 ⁷ / ₈ in 14.92 cm
60-1923	Straight without Lock, Flat Wide Handle	Very Delicate 9.0 mm	5 ¹ / ₄ in 13.5 cm
60-1921	Straight without Lock, Flat Handle	Delicate 10 mm	5 ¹ / ₂ in 14 cm
60-1919	Curved with Lock, Flat Wide Handle	Very Delicate 9.0 mm	5 ¹ / ₄ in 13.5 cm
60-1909	Curved with Lock, Flat Handle	Delicate 10 mm	5 ¹ / ₂ in 14 cm
60-1920	Curved without Lock, Flat Wide Handle	Very Delicate 9.0 mm	5 ¹ / ₄ in 13.5 cm
60-1910	Curved without Lock, Flat Handle	Delicate 10 mm	5 ¹ / ₂ in 14 cm



60-1917

Castroviejo Needle Holder

12 mm Jaws, Flat Handle, Standard Pattern

CODE	DESCRIPTION	LENGTH
60-1924	Straight with Lock	5 ³ / ₄ in 14.5 cm
60-1925	Curved with Lock	5 ³ / ₄ in 14.5 cm



60-1924

Needle Holders

Cohan Needle Holder

7.0 mm Jaws, Round Handles

CODE	DESCRIPTION	LENGTH
60-1895	Curved with Lock	4 in 10 cm
60-1894	Curved without Lock	4 in 10 cm



McPherson Needle Holder

Smooth 10 mm Tapered Jaw, Extra Delicate

CODE	DESCRIPTION	LENGTH
60-1892	Curved with Lock	4 7/8 in 10.5 cm



Titanium Barraquer Needle Holder

Medium Jaws

CODE	DESCRIPTION	LENGTH
60-5504	Straight with Lock	4 1/4 in 11 cm
60-5503	Straight without Lock	4 1/4 in 11 cm
60-5505	Curved with Lock	4 1/4 in 11 cm
60-5502	Curved without Lock	4 1/4 in 11 cm

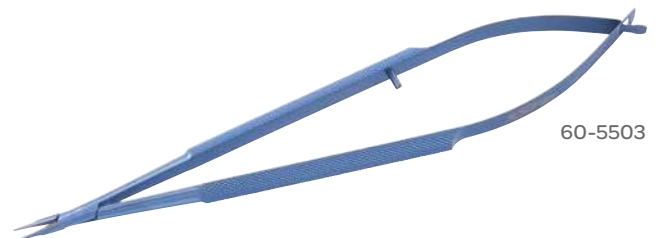

Titanium Micro Needle Holder

Smooth Jaws, Round Handles

CODE	DESCRIPTION	LENGTH
60-5510	Straight with Lock	5 in 12.5 cm
60-5509	Straight without Lock	5 in 12.5 cm
60-5511	Curved without Lock	5 in 12.5 cm

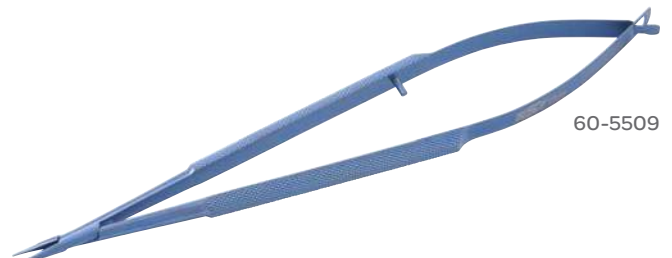

Needle Holders

Titanium Micro Needle Holder

Smooth Jaws, Round Handles

CODE	DESCRIPTION	LENGTH
60-5520	Straight without Lock	5 $\frac{3}{8}$ in 13.6 cm
60-5524	Curved with Lock	5 $\frac{3}{8}$ in 13.6 cm
60-5526	Curved without Lock	5 $\frac{3}{8}$ in 13.6 cm

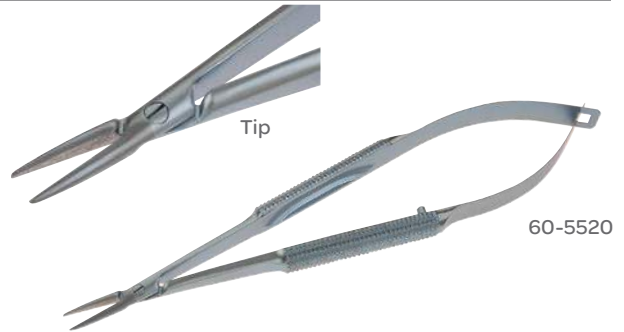

60-5520

Troutman-Barraquer Needle Holder

Smooth Jaws, Round Handles

CODE	DESCRIPTION	LENGTH
60-1901	Angled with Lock	4 $\frac{1}{2}$ in 11.5 cm
60-1902	Angled without Lock	4 $\frac{1}{2}$ in 11.5 cm



60-1902

Troutman Needle Holder

Round Handles, 9.0 mm Jaws

CODE	DESCRIPTION	LENGTH
60-1900	Curved with Lock	4 $\frac{3}{4}$ in 12 cm
60-1899	Curved without Lock	4 $\frac{3}{4}$ in 12 cm



60-1899

Ultra™ Needle Holder

Conical 9.0 mm Jaws, Wide Handle

CODE	DESCRIPTION	LENGTH
60-1876	Straight without Lock	5 $\frac{3}{8}$ in 13.6 cm



60-1876

Plates

Berke-Jaeger Lid Plate

Sterling

CODE	DESCRIPTION	LENGTH
60-1070	$\frac{3}{8}$ in 10 mm	4 $\frac{1}{2}$ in 10.8 cm



Probes

Bowman Lacrimal Probe

Sterling

CODE	DESCRIPTION
60-1976	Size 0000-000
60-1977	Size 00-0
60-1978	Size 1-2
60-1979	Size 3-4
60-1980	Size 5-6
60-1981	Size 7-8

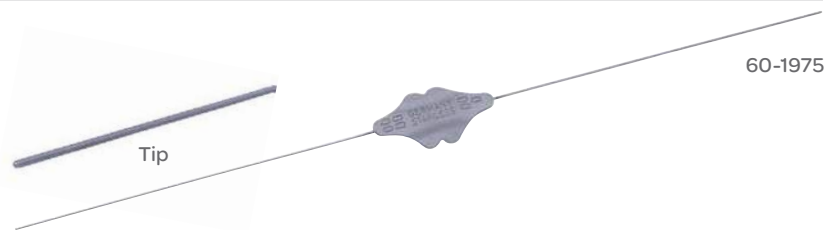

Pigtail Probe

With Suture Eyes Just Behind Blunt Ends

CODE	LENGTH
60-1989	6 in 15 cm



Quickert Lacrimal Intubation Probe

CODE	DESCRIPTION
60-2100	#00
60-2110	#0
60-2111	#1
60-2112	#2
60-2113	#3
60-2114	#4

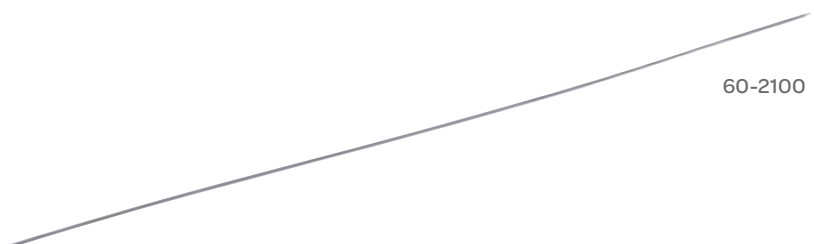

Probes

Williams Lacrimal Probe

Ball Tip, Sterling

CODE	DESCRIPTION
60-1982	Size 00-0
60-1983	Size 1-2
60-1984	Size 3-4
60-1985	Size 5-6
60-1986	Size 7-8



Retractors

Desmarres Lid Retractor

CODE	SIZE	WIDTH	LENGTH
60-1404	Size 0	11 mm	5½ in 14 cm
60-1405	Size 1	13 mm	5½ in 14 cm
60-1406	Size 2	15 mm	5½ in 14 cm
60-1407	Size 3	16 mm	5½ in 14 cm
60-1403	Size 4	18 mm	5½ in 14 cm



Graether Collar Button

CODE	DESCRIPTION	LENGTH
60-1388	Angled, 23 Gauge	1 in 2.54 cm



Graether Collar Button on Handle

CODE	DESCRIPTION	LENGTH
60-1389	Straight	4¾ in 12 cm
60-1390	Angled	4¾ in 12 cm

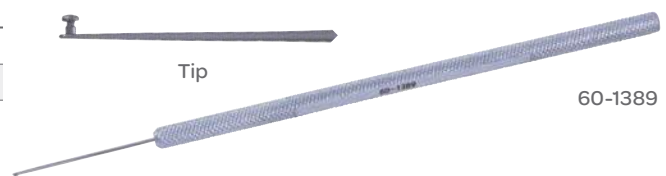

Retractors

Jaffe Lid Retractor

Set of Two

CODE	DESCRIPTION
60-1408	9.0 mm Wide

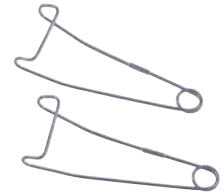

Rizzuti Expressor & Iris Retractor

CODE	DESCRIPTION
60-1394	3.0 mm



Rollet Lacrimal Sac Retractor

CODE	DESCRIPTION	LENGTH
50-6536	Four Prong, Sharp	5¼ in 13.3 cm



Schepens Orbital Retractor

CODE	DESCRIPTION	LENGTH
60-5008	Smooth 14 x 57 mm Blade with Notched End, 4.5 mm Wide Notch	6 in 15 cm



Stevenson Lacrimal Sac Retractor

CODE	DESCRIPTION	LENGTH
60-1413	Curved Teeth, 1.0 x 5.0 mm, Spread 20 mm	3½ in 9.0 cm



Rings

Fine-Thornton Swivel Ring

CODE	DESCRIPTION
60-7065	13 mm

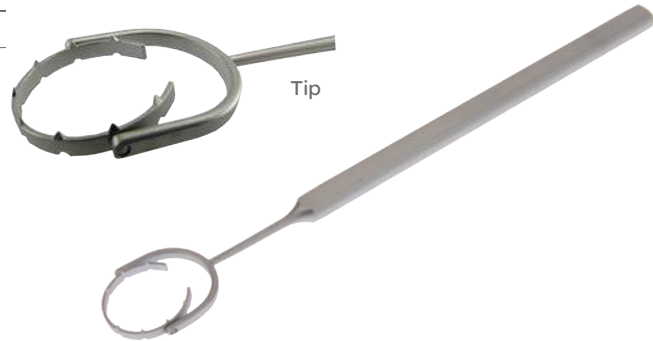

Flieringa Fixation Ring

CODE	DESCRIPTION
60-3015	15 mm Diameter
60-3017	17 mm Diameter
60-3022	22 mm Diameter

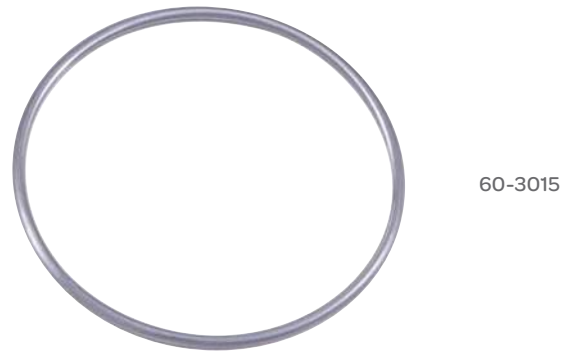

Thornton Fixation Ring

16 mm Ring with Multiple Teeth

CODE	DESCRIPTION	LENGTH
60-7000		4 3/4 in 12 cm
60-7001	Swivel Handle	4 3/4 in 12 cm

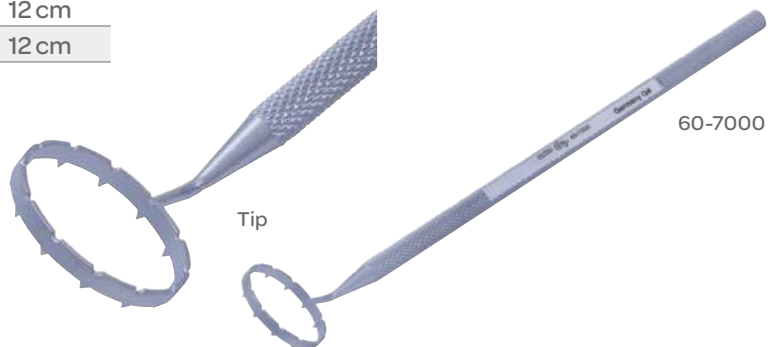

Rotators

Pisacano Nucleus Rotator

CODE	DESCRIPTION
60-1013	Horizontal Flat Disc Shaped Tip

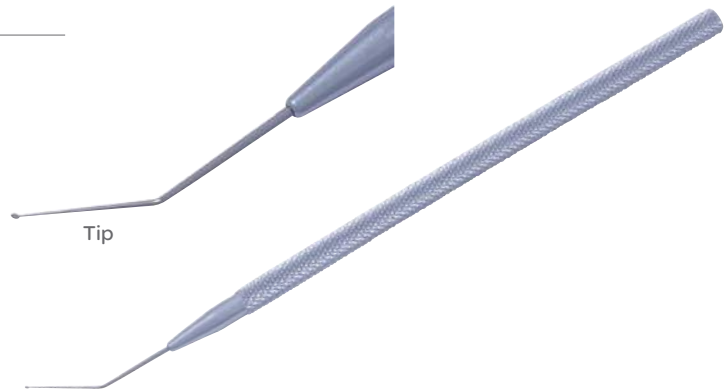

Bechert-Hoffer Nucleus Rotator

CODE	DESCRIPTION
60-1116	$\frac{3}{8}$ in 10 mm

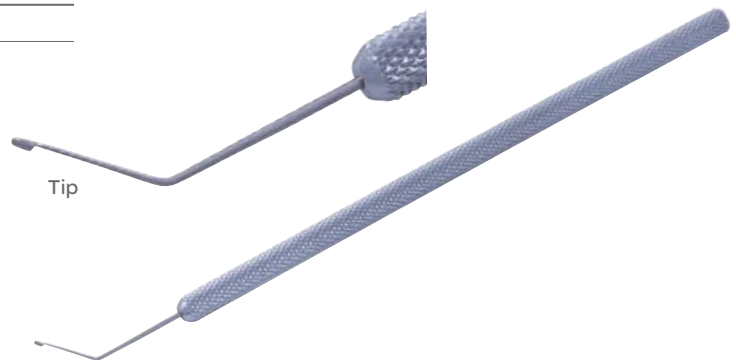

Scissors

Aebli Corneal Scissors

Delicate, Blunt Tips

CODE	DESCRIPTION	LENGTH
60-1773	Angled Right	4½ in 11.5 cm
60-1774	Angled Left	4½ in 11.5 cm



Barraquer Iris Scissors

Delicate, Blunt Blades

CODE	BLADES	LENGTH
60-1821	7.0 mm	2 in 5.0 cm
60-1831	10 mm	2 in 5.0 cm



Castroviejo Corneal Scissors

Miniature, Blunt Tips

CODE	DESCRIPTION	LENGTH
60-1752	Angled Left	4⅛ in 10.5 cm
60-1753	Angled Right	4⅛ in 10.5 cm

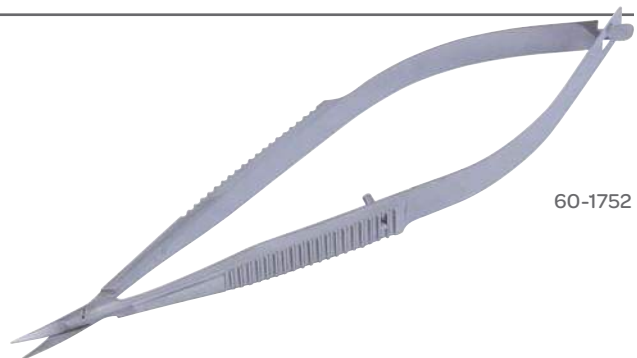

Castroviejo Corneal Scissors

Medium Pattern, Blunt Tips

CODE	DESCRIPTION	LENGTH
60-1754	Strongly Curved	4½ in 11.5 cm



Scissors

Castroviejo Corneal Scissors

Delicate, Blunt Tips

CODE	DESCRIPTION	LENGTH
60-1756	Angled	4 $\frac{1}{8}$ in 10.5 cm



Castroviejo Corneal Section Scissors

Micro Pattern, Lower Blade 6.0 mm, Upper Blade 5.5 mm, Blunt Tips

CODE	DESCRIPTION	LENGTH
60-1786	Curved Right	4 $\frac{1}{4}$ in 10.8 cm
60-1787	Curved Left	4 $\frac{1}{4}$ in 10.8 cm

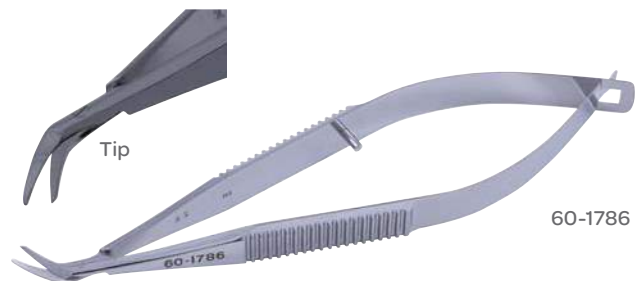

Castroviejo Corneal Section Scissors

Lower Blade 14 mm, Upper Blade 13 mm

CODE	DESCRIPTION	LENGTH
60-1776	Curved Right	4 $\frac{1}{4}$ in 10.8 cm
60-1779	Curved Left	4 $\frac{1}{4}$ in 10.8 cm



Castroviejo Corneal Scissors

Curved Blunt Tips

CODE	BLADES	LENGTH
60-1768	12 mm	4 in 10 cm
60-1770	7.0 mm	4 in 10 cm

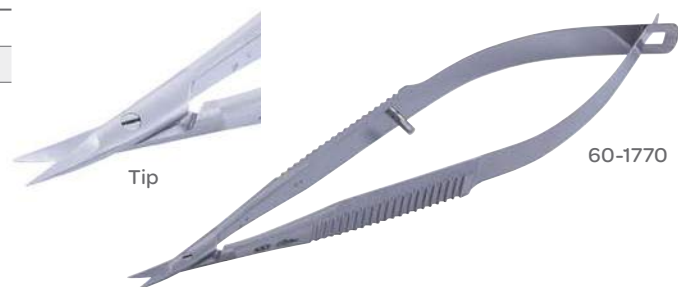

Scissors

Castroviejo Keratoplasty Scissors

Lower Blade 1.0 mm, Longer Than Upper Blade

CODE	DESCRIPTION	LENGTH
60-1855	Blunt Angled Blades, Probe Tip	4 ¼ in 10.8 cm



Castroviejo Keratoplasty Scissors

Miniature Pattern, Blunt Tips, Wide Handle

CODE	DESCRIPTION	LENGTH
60-1755	Slightly Curved	5 ¼ in 13.5 cm



Castroviejo Micro Scissors

Round Handle, Sharp Delicate Blades

CODE	DESCRIPTION	LENGTH
55-8049	Angled 25°	4 ½ in 11.5 cm
55-8050	Angled 45°	4 ½ in 11.5 cm
55-8051	Angled 60°	4 ½ in 11.5 cm
55-8053	Angled 125°	4 ½ in 11.5 cm

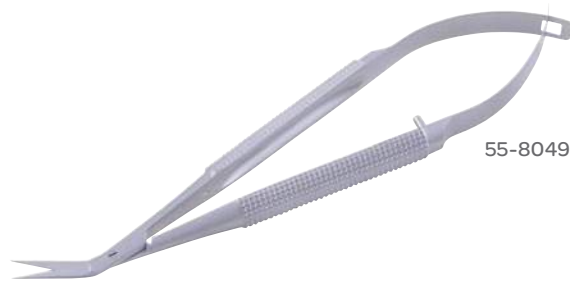

Castroviejo Corneal Section Scissors

Medium Pattern, Wide Handle

CODE	DESCRIPTION	LENGTH
60-1784	Right	4 ⅞ in 10.5 cm
60-1783	Left	4 ⅞ in 10.5 cm



Scissors

Dissecting Scissors

With Ball Tip

CODE	DESCRIPTION	LENGTH
02-5063	Curved	4 1/8 in 10.5 cm
02-5065	Angled	4 1/8 in 10.5 cm



Dissecting Scissors

With Probe

CODE	DESCRIPTION	LENGTH
02-5062	Straight	4 in 10 cm



Enucleation Scissors

CODE	DESCRIPTION	LENGTH
60-1749	Light Curve	5 1/2 in 14 cm
60-1750	Medium Curve	5 1/2 in 14 cm
60-1751	Strong Curve	5 1/2 in 14 cm



Gills-Vannas Capsulotomy Scissors

Extra Thin Long Blades, Sharp Tips

CODE	DESCRIPTION	LENGTH
60-1862	Straight	3 3/8 in 8.5 cm
60-1863	Curved	3 3/8 in 8.5 cm
60-1864	Angled forward	3 3/8 in 8.5 cm



Scissors

Iris Classic Plus® Scissors

Stellite Edge Inserts, Sharp/Sharp

CODE	DESCRIPTION	LENGTH
34-6500	Straight	4 ³ / ₈ in 11.1 cm
34-6503	Curved	4 ³ / ₈ in 11.1 cm



34-6500

Iris Classic® Scissors

Sharp/Sharp

CODE	DESCRIPTION	LENGTH
36-5000	Straight	4 ¹ / ₂ in 11.4 cm
36-5001	Curved	4 ¹ / ₂ in 11.4 cm



36-5000

Iris Scissors

Standard Pattern

CODE	DESCRIPTION	LENGTH
02-2009	Straight	3 ⁵ / ₈ in 9.2 cm
02-2010	Straight	4 ⁵ / ₈ in 11.7 cm
02-2011	Straight	4 ¹ / ₂ in 11.5 cm
02-2012	Straight	5 in 12.5 cm
02-2109	Curved	3 ¹ / ₂ in 9.0 cm
02-2110	Curved	4 ¹ / ₈ in 10.5 cm
02-2111	Curved	4 ¹ / ₂ in 11.5 cm
02-2112	Curved	5 in 12.5 cm



02-2009

Iris Scissors

Tungsten Carbide Inserts

CODE	DESCRIPTION	LENGTH
32-706	Straight	4 ¹ / ₂ in 11.5 cm
32-676	Straight, One Serrated Blade	4 ¹ / ₂ in 11.5 cm
32-705	Curved	4 ¹ / ₂ in 11.5 cm
32-675	Curved, One Serrated Blade	4 ¹ / ₂ in 11.5 cm



32-705

Scissors

Iris Scissors

Sharp Tips

CODE	DESCRIPTION	LENGTH
60-1814	Straight	4½ in 11.5 cm
60-1815	Curved	4½ in 11.5 cm



60-1814

Iris Scissors

Large Ribbon Ring Handles with Flat Shanks, Heavy Pattern, Blunt Tips

CODE	DESCRIPTION	LENGTH
60-1823	Straight	4 in 10 cm
60-1824	Curved	4 in 10 cm



60-1823

Iris Scissors

Large Ribbon Handles with Flat Shanks

CODE	DESCRIPTION	LENGTH
60-1825	Straight	4 in 10 cm
60-1826	Curved	4½ in 10.5 cm



60-1825

Iris Scissors

Delicate, Large Ring Handles

CODE	DESCRIPTION	LENGTH
60-1827	Straight	4 in 10 cm
60-1828	Curved	4 in 10 cm



60-1827

Iris Scissors

Standard Pattern

CODE	DESCRIPTION	LENGTH
60-1829	Straight	4 in 10 cm
60-1830	Curved	4 in 10 cm



60-1829

Scissors

Iris Scissors

Large Ribbon Handles with Flat Shanks

CODE	DESCRIPTION	LENGTH
60-1843	Straight, Sharp Tips	4 in 10 cm
60-1845	Straight, Blunt Tips	4 in 10 cm
60-1844	Curved, Sharp Tips	4 in 10 cm
60-1846	Curved, Blunt Tips	4 in 10 cm



60-1843

Iris Scissors

Standard Pattern

CODE	DESCRIPTION	LENGTH
60-1847	Straight	4 1/8 in 10.5 cm
60-1848	Curved	4 1/8 in 10.5 cm



60-1847

Iris Scissors

Micro-Miniature Pattern, 8.0 mm Blades

CODE	DESCRIPTION	LENGTH
60-1852	Straight	4 in 10 cm
60-1854	Curved	4 in 10 cm



60-1852

Jaffe Stitch Scissors

Very Sharp Tips, Medium Blades

CODE	DESCRIPTION	LENGTH
60-1817	Curved	4 1/8 in 10.5 cm



Katzin Corneal Transplant Scissors

Miniature Pattern, Upper Blade Shorter than Lower Blade

CODE	DESCRIPTION	LENGTH
60-1759	Strongly Curved Left	4 1/8 in 10.5 cm
60-1760	Strongly Curved Right	4 1/8 in 10.5 cm



60-1759

Scissors

Knapp Dissecting Scissors

CODE	DESCRIPTION	LENGTH
02-4010	Straight	4 $\frac{1}{16}$ in 10.3 cm
02-4110	Curved	4 $\frac{1}{16}$ in 10.3 cm



02-4010

Knapp Iris Scissors

CODE	DESCRIPTION	LENGTH
54-6524	Straight, Sharp/Blunt	4 in 10 cm
54-6526	Straight, Blunt/Blunt	4 in 10 cm
54-6525	Curved, Sharp/Blunt	4 in 10 cm
54-6527	Curved, Blunt/Blunt	4 in 10 cm



54-6524

Knapp Scissors

CODE	DESCRIPTION	LENGTH
02-2042	Straight, Sharp/Sharp	4 $\frac{3}{4}$ in 12 cm
02-2043	Straight, Blunt/Blunt	4 $\frac{3}{4}$ in 12 cm
02-2142	Curved, Sharp/Sharp	4 $\frac{3}{4}$ in 12 cm
02-2143	Curved, Blunt/Blunt	4 $\frac{3}{4}$ in 12 cm



02-2042

Knapp Strabismus Scissors

Rounded Blades

CODE	DESCRIPTION	LENGTH
60-1865	Straight, Blunt/Blunt	4 $\frac{1}{8}$ in 10.5 cm
60-1866	Curved, Blunt/Blunt	4 $\frac{1}{8}$ in 10.5 cm



60-1865

Ceramic Coated Iris Scissors

Ceramic Coated, Razor Edges and Micro Serrations

CODE	DESCRIPTION	LENGTH
222.20.61	Straight	4 $\frac{1}{2}$ in 11.5 cm
222.21.61	Curved	4 $\frac{1}{2}$ in 11.5 cm



222.20.61

Scissors

Ceramic Coated Stevens Tenotomy Scissors

Ceramic Coated, Razor Edges and Micro Serrations

CODE	DESCRIPTION	LENGTH
222.50.62	Straight	4 1/8 in 10.5 cm
222.50.63	Curved	4 1/8 in 10.5 cm
224.67.63	Curved	5 1/8 in 13 cm



McPherson-Vannas Iris Scissors

Miniature Pattern, Sharp Tips

CODE	DESCRIPTION	LENGTH
60-1816	Curved	3 1/3 in 8.5 cm



Micro Scissors

Wide Handle

CODE	DESCRIPTION	LENGTH
05-1220	Straight	5 in 12.5 cm
05-1230	Straight, Vannas-Type Cutting Blades 5.0 mm Blades	5 in 12.5 cm
05-1221	Curved	5 in 12.5 cm
05-1231	Curved, Vannas-Type Cutting Blades 5.0 mm Blades	5 in 12.5 cm



Razor Edge Iris Scissors

Black Handle without Serrations

CODE	DESCRIPTION	LENGTH
80-2010	Straight	4 1/2 in 11.5 cm
80-2011	Curved	4 1/2 in 11.5 cm



Scissors

Razor Edge Stevens Tenotomy Scissors

Black Handle without Serrations

CODE	DESCRIPTION	LENGTH	
80-5012	Straight	5 in	12.5 cm
80-5009	Curved	4½ in	11.5 cm
80-5013	Curved	5 in	12.5 cm



80-5012

Reynolds Dissecting Scissors

Tenotomy Tip, Delicate Pattern

CODE	DESCRIPTION	LENGTH	
04-6712	Curved	5 in	12.5 cm
04-6714	Curved	5⅝ in	14.3 cm



Stevens Serrated Tenotomy Scissors

With Black Handles

CODE	DESCRIPTION	LENGTH	
86-5012	Straight	4½ in	11.5 cm
86-5013	Curved	4½ in	11.5 cm



86-5012

Serrated Iris Scissors

With Black Handles

CODE	DESCRIPTION	LENGTH	
86-2011	Straight	4½ in	11.5 cm
86-2111	Curved	4½ in	11.5 cm



86-2011

Scissors

Shepherd-Westcott Tenotomy Scissors

20 mm from Screw to Tip, Blunt Tips

CODE	DESCRIPTION	LENGTH
60-1822	Curved	4 $\frac{7}{8}$ in 12.4 cm



Stern-Gills Scissors

CODE	DESCRIPTION
60-1869	10 mm Angled Forward

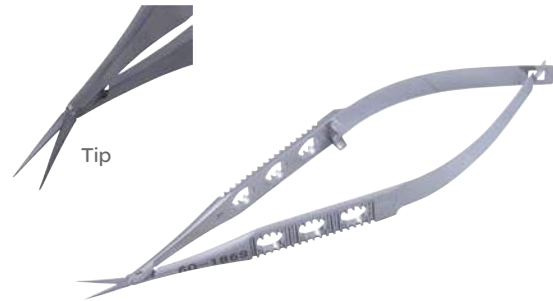

Stevens Tenotomy Scissors

Sharp Tips

CODE	DESCRIPTION	LENGTH
02-5002	Straight	4 in 10 cm
02-5003	Curved	4 in 10 cm



02-5002

Stevens Tenotomy Scissors

Tungsten Carbide Inserts

CODE	DESCRIPTION	LENGTH
32-708	Straight	4 $\frac{1}{2}$ in 11.5 cm
32-709	Curved	4 $\frac{1}{2}$ in 11.5 cm



32-708

Scissors

Stevens Tenotomy Scissors

Blunt Tips

CODE	DESCRIPTION	LENGTH
02-5012	Straight	4 in 10 cm
60-1805	Straight	4½ in 11.5 cm
02-5013	Curved	4 in 10 cm
60-1806	Curved	4½ in 11.5 cm



02-5012

Stevens Tenotomy Scissors

Curved Heavy Pattern Blunt Tips

CODE	DESCRIPTION	LENGTH
60-1803	Large Ribbon Ring Handles with Flat Shanks	4 in 10 cm

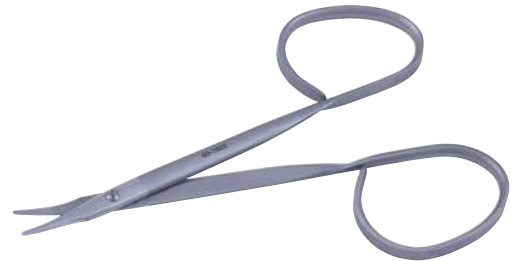

Stevens Tenotomy Scissors

Large Ribbon Ring Handles with Flat Shanks, Light Pattern

CODE	DESCRIPTION	LENGTH
60-1804	Straight, Blunt	4 in 10 cm
60-1807	Curved, Blunt	3¾ in 9.8 cm



60-1804

Stitch Scissors

Large Ribbon Ring Handles with Flat Shanks, Curved

CODE	DESCRIPTION	LENGTH
60-1813	Sharp, Delicate	3¾ in 9.5 cm
60-1812	Sharp, Extra Delicate	3¾ in 9.5 cm



60-1813

Scissors

Stitch Scissors

Sharp Tips, Fine Delicate Blades

CODE	DESCRIPTION	LENGTH
60-1810	Straight	4 ½ in 11.5 cm



Strabismus Scissors

Blunt Tips, Tungsten Carbide Inserts

CODE	DESCRIPTION	LENGTH
32-700	Curved	4 ½ in 11.5 cm
32-701	Straight	4 ½ in 11.5 cm



32-700

Strabismus Scissors

Ribbon Handles

CODE	DESCRIPTION	LENGTH
60-1856	Straight	4 ¼ in 10.8 cm
60-1857	Curved	4 ¼ in 10.8 cm



60-1856

Razor Edge Iris Scissors

Black Handle, Gold Screw, One Cutting Edge with Micro Serrations

CODE	DESCRIPTION	LENGTH
212.20.11	Straight	4 ½ in 11.5 cm
212.21.11	Curved	4 ½ in 11.5 cm



212.20.11

Scissors

Razor Edge Stevens Tenotomy Scissors

Black Handle, Gold Screw, One Cutting Edge with Micro Serrations

CODE	DESCRIPTION	LENGTH
212.50.12	Straight	4½ in 11.5 cm
212.50.13	Curved	4½ in 11.5 cm



212.50.13

Serrated Iris Scissors

CODE	DESCRIPTION	LENGTH
85-2010	Straight	4⅞ in 10.5 cm
85-2013	Straight	4½ in 11.5 cm
85-2015	Curved	4½ in 11.5 cm



85-2010

Razor Edge Serrated Iris Scissors

Gold Screw, One Cutting Edge with Micro Serrations

CODE	DESCRIPTION	LENGTH
202.20.10	Straight	4⅞ in 10.5 cm
202.21.10	Curved	4⅞ in 10.5 cm



202.20.10

Razor Edge Serrated Stevens Tenotomy Scissors

Gold Screw, One Cutting Edge with Micro Serrations

CODE	DESCRIPTION	LENGTH
202.50.12	Straight	5⅞ in 13 cm
202.50.13	Curved	5⅞ in 13 cm



202.50.13

Scissors

Razor Edge Serrated Stevens Tenotomy Scissors

Gold Screw, One Cutting Edge with Micro Serrations

CODE	DESCRIPTION	LENGTH
204.67.13	Curved	5½ in 13 cm

Troutman-Castroviejo Corneoscleral Scissors

Micro Pattern, 6.0 mm Equal Length Blades

CODE	DESCRIPTION	LENGTH
60-1792	Curved Right	4½ in 10.5 cm
60-1793	Curved Left	4½ in 10.5 cm



60-1792

Troutman-Katzin Corneal Scissors

With Lock, Medium Blades, Blunt Tips

CODE	DESCRIPTION	LENGTH
60-1762	Curved Left	4½ in 10.5 cm



Troutman-Katzin Corneal Scissors

Without Lock, Small Blades, Blunt Tips

CODE	DESCRIPTION	LENGTH
60-1763	Curved Right	4½ in 10.5 cm
60-1764	Curved Left	4½ in 10.5 cm



60-1763

Scissors

Utility Scissors

Large Ribbon Ring Handles with Flat Shanks, Blunt

CODE	DESCRIPTION	LENGTH
60-1853	Lightly Curved	4 in 10 cm



Vannas Capsulotomy Scissors

Very Delicate 6.0 mm Blades

CODE	DESCRIPTION	LENGTH
60-1833	Curved, Wide Handle	4 ½ in 11.5 cm



Vannas Capsulotomy Scissors

Very Delicate 6.0 mm Blades

CODE	DESCRIPTION	LENGTH
60-1834	Straight Blades	3 ¾ in 8.5 cm
60-1835	Curved Blades	3 ¾ in 8.5 cm
60-1836	Up-Angled Blades	3 ¾ in 8.5 cm
60-1839	Side-Angled Blades	3 ¾ in 8.5 cm



60-1835

Westcott Conjunctival Scissors

Wide Handle, Blunt Tips

CODE	DESCRIPTION	LENGTH
60-1859	Slightly Curved	5 in 12.5 cm



Scissors

Westcott Stitch Scissors

Curved, Sharp Tips

CODE	DESCRIPTION	LENGTH
60-1808	21 mm from Screw to Tip	4 ½ in 11.5 cm



Westcott Tenotomy Scissors

Curved Blunt Tips

CODE	DESCRIPTION	LENGTH
60-1796	Left-Handed	4 ½ in 11.5 cm
60-1797	Right-Handed	4 ½ in 11.5 cm
60-1799	Wide Handle, Right-Handed	5 ½ in 14 cm
60-1800	Micro Pattern, Curved Right	5 ½ in 14 cm



60-1796

Westcott Utility Scissors

CODE	DESCRIPTION	LENGTH
60-1842	Curved, Round Tips	5 in 12.5 cm



Wilmer Angled Scissors

CODE	DESCRIPTION	LENGTH
60-1850	Angled on Flat	4 in 10 cm



Shields

Fox Eye Shield

CODE	DESCRIPTION
60-3006	Aluminum

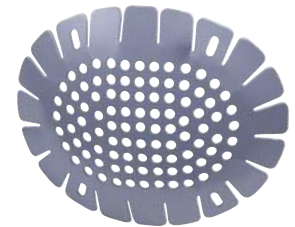

Spatulas

Barraquer Cyclodialysis Spatula

CODE	TIP	LENGTH
60-1068	0.5 mm	4 ³ / ₄ in 12 cm



Barraquer Iris Spatula

Hexagonal Handle

CODE	TIP	LENGTH
60-1067	0.25 mm	3 ¹ / ₂ in 9 cm



Castroviejo Cyclodialysis Spatula

Double-Ended

CODE	SIZE	LENGTH
60-1074	0.5 x 15 x 0.5 mm	5 ¹ / ₄ in 13.5 cm
60-1076	0.25 x 15 x 0.25 mm	5 ¹ / ₄ in 13.5 cm
60-1077	1.0 x 16 x 0.75 mm	5 ¹ / ₄ in 13.5 cm



60-1074

Castroviejo Synechia Spatula

CODE	DESCRIPTION	LENGTH
60-1066	Double-Ended	5 ¹ / ₂ in 14 cm



Spatulas

Culler Iris Spatula

CODE	DESCRIPTION	LENGTH
60-1090	2.0 x 33 mm	5 in 12.5 cm
60-1091	1.0 x 28 mm	5 in 12.5 cm



Hirschman Lens Spatula

CODE	DESCRIPTION
60-1097	Lens Spatula

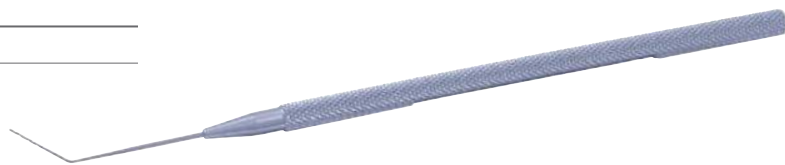

Iris Spatula

CODE	DESCRIPTION	LENGTH
60-1092	Malleable	5 in 12.5 cm



Jaffe Lens Spatula

Flat, Smooth

CODE	DESCRIPTION	LENGTH
60-1109	5 mm Wide	4 3/4 in 12 cm



Johnson Spatula

CODE	DESCRIPTION
60-1095	Spatula



Wheeler Cyclodialysis Spatula

CODE	DESCRIPTION
60-1099	Double-Ended



Speculums

Alfonso Eye Speculum, Newborn

CODE	BLADE WIDTH	SPREAD
60-1974	5 mm	1 in 2.5 cm



Barraquer Eye Speculum

CODE	DESCRIPTION	BLADE WIDTH
60-1963	Adult	14 mm
60-1964	Heavy Wire, Adult	14 mm
60-1966	Solid Blades, Adult	14 mm
60-1962	Fenestrated, Pediatric	5.0 mm
60-1967	Fenestrated, Child	10 mm
60-1969	Solid Blades, Child	11 mm

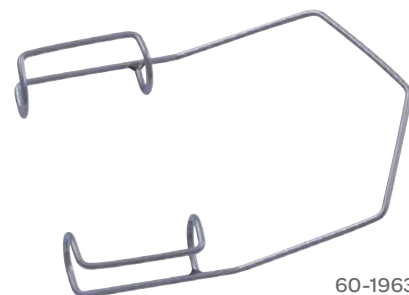

60-1963

Castroviejo Speculum

Medium Curved Arms

CODE	WIDTH	SPREAD
60-1948	17 mm	40 mm

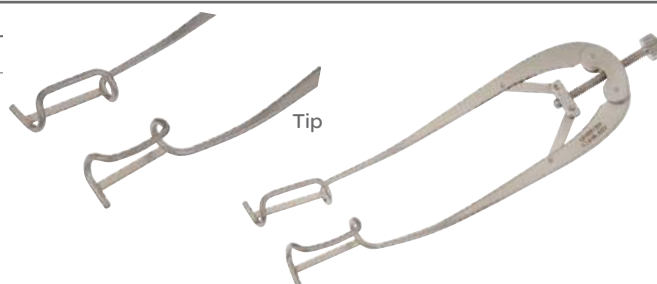

Speculums

Cook Eye Speculum

CODE	SIZE	BLADE WIDTH	LENGTH
60-1958	Child	11 mm	1 $\frac{3}{4}$ in 4.5 cm
60-1959	Adult	15 mm	1 $\frac{3}{4}$ in 4.5 cm



60-1958

Guyton-Park Speculum

Horizontal Suture Posts, Fenestrated Blades

CODE	BLADE WIDTH	LENGTH
60-1937	14 mm	3 $\frac{3}{8}$ in 7.5 cm



Kratz-Barraquer Speculum

CODE	DESCRIPTION
60-1960	Child

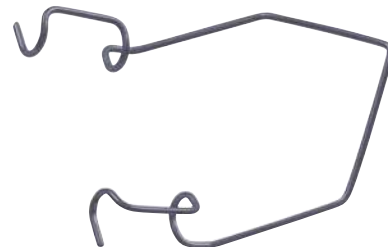

Lancaster Eye Speculum

CODE	BLADE WIDTH	SPREAD	LENGTH
60-1951	15 mm	35 mm	3 $\frac{1}{4}$ in 8.3 cm



Speculums

Lester-Burch Speculum

CODE	DESCRIPTION	LENGTH
60-1953	21 mm Wide Blades, Spread 32 mm	3¼ in 8.3 cm



Lieberman Speculum

17 mm Blades

CODE	DESCRIPTION
60-2003	K-Wire, Open Blades
60-2004	V-Wire, Open Blades
60-2005	Closed Blades



Knapp Eye Speculum

CODE	BLADE WIDTH	SPREAD	LENGTH
60-1954	14 mm	60 mm	3⅜ in 8.5 cm



Kratz-Barraquer Speculum

CODE	DESCRIPTION	LENGTH
60-1968	Open Blades, 14 mm Wide	
60-1970	15 mm Wide with Wings	1½ in 3.8 cm

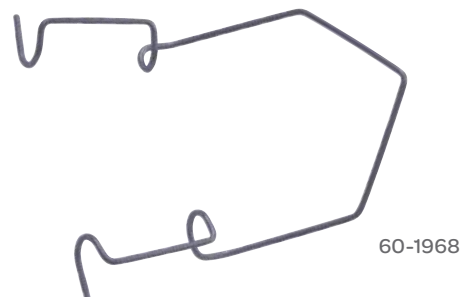

Speculums

Maumenee-Park Speculum

Fenestrated Blades

CODE	BLADE SPREAD	BLADE WIDTH	LENGTH
60-1941	43 mm	14 mm	3¼ in 8.3 cm



Pierce Eye Speculum

CODE	BLADE WIDTH	SPREAD
60-1961	11 mm	20 mm



Sauer Speculum

CODE	BLADE WIDTH	SPREAD
60-1971	4.0 mm	14 mm
60-1972	8.0 mm	25 mm



Temporal Wire Speculum

Closed Wire

CODE	BLADE WIDTH	SPREAD	LENGTH
60-1412	14 mm	43 mm	

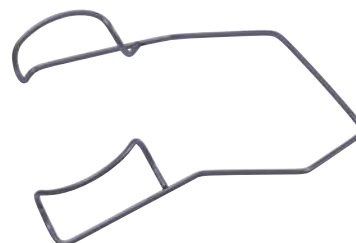

Spoons

Bunge Evisceration Spoon

CODE	DESCRIPTION	LENGTH
60-1295	Large	5½ in 14 cm



Spuds

Ellis Foreign Body Spud

CODE	DESCRIPTION	LENGTH
60-1443	Curved 1.0 mm Wide Blade	4 ¾ in 12 cm



Francis Spud

CODE	DESCRIPTION	LENGTH
60-1439	Flag-Shaped, Sharp	4 ¾ in 12 cm

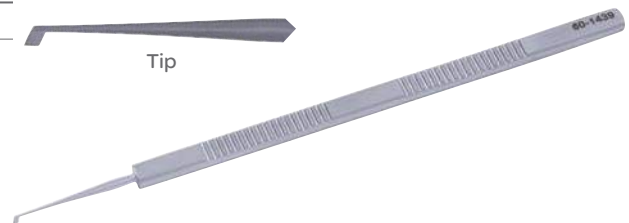

Foreign Body Spud

CODE	DESCRIPTION	LENGTH
60-1441	Arrow-Shaped Head with Guard	4 ¾ in 12 cm



Golf Club Foreign Body Spud

CODE	DESCRIPTION
60-1438	Small, Sharp



Tonometers



Tonometer

CODE	DESCRIPTION	CODE	DESCRIPTION
60-6030	Schiötz Tonometer, Complete in Fitted Case	60-6031	Allen-Schiötz Tonometer