



Scan the code above to learn more about our Cardiovascular/Thoracic portfolio.

Cardiovascular/ Thoracic Portfolio



symmetry surgical™

Cardiovascular/Thoracic



Approximators	CVT-2	Punches	CVT-136
Cannulas	CVT-3	Raspatory	CVT-137
Clamps	CVT-3	Retractors	CVT-138
Containers	CVT-55	Rib Spreader	CVT-186
Cords	CVT-63	Rongeurs	CVT-187
Cups	CVT-63	Saws	CVT-188
Dilators	CVT-64	Scissors	CVT-188
Dissectors	CVT-68	Shears	CVT-216
Elevators	CVT-70	Spatulas	CVT-218
Forceps	CVT-71	Spreaders	CVT-218
Hooks	CVT-121	Stringers	CVT-220
Knife Handles	CVT-121	Strippers	CVT-222
Knives	CVT-122	Suction Tubes	CVT-223
Loops	CVT-122	Sump Suction	CVT-225
Markers	CVT-122	Tourniquets	CVT-225
Needle Holders	CVT-123	Trocars	CVT-225
Needles	CVT-135	Tunnelers	CVT-226
Obturator	CVT-135	Valvulotomes	CVT-227
Pliers	CVT-135	Wire & Pin Cutters	CVT-227

Questions? Contact us at customerservice@symmetrysurgical.com or learn more at symmetrysurgical.com



The Surgical Instrument Desk Reference

How to Use Our Catalog

The Symmetry Surgical catalog is designed with you in mind, to be your trusted resource for surgical instrumentation. We took great care in creating an easy-to-use, robust catalog and we think you'll be pleased with the design as you become more familiar with our broad portfolio.

Layout

The catalog is organized by surgical specialty *and* product function.

And we know that it is difficult to pick up an instrument and know what specialty it's listed in. To make your job easier, we've sorted the instruments in our portfolio by surgical function, too, including Energy, Laparoscopic, Retractors and Sterilization Solutions.

U.S. Customer Service

Your Symmetry Surgical Customer Service team wants to make ordering surgical instruments the easiest part of your day. We accept orders via phone, fax, email, our website, Global Healthcare Exchange (GHX) and through the mail.

PHONE

1.800.251.3000

(Available Monday through Friday, 8:30 AM–6:30 PM EST)

FAX

1.800.342.3272

EMAIL

customerservice@symmetrysurgical.com

ONLINE

symmetrysurgical.com

MAILING ADDRESS

Symmetry Surgical
Attn: Customer Service
3034 Owen Drive
Antioch, TN 37013

The Surgical Instrument Desk Reference

International Customer Service

PHONE

Symmetry Surgical Switzerland GmbH
+41 (0) 52 557 59 00
(Available Monday through Friday, 7:00-16:00 GMT)

Symmetry Surgical, Inc., USA
1.615.964.5672
(Available Monday through Friday, 8:30 AM-6:30 PM EST)

FAX

Symmetry Surgical Switzerland GmbH
+41 (0) 52 557 59 99

EMAIL

customerservice@symmetrysurgical.com
internationalorders@symmetrysurgical.com

ONLINE

symmetrysurgical.com

MAILING ADDRESS

Symmetry Surgical Switzerland GmbH
Bühlstrasse 27
CH-8200 Schaffhausen
Switzerland

Symmetry Surgical, Inc.
3034 Owen Drive
Antioch, TN 37013

INTERNATIONAL PAYMENT TERMS/RETURN GOODS POLICY/INSTRUMENT REPAIR & RESTORE PROGRAM/LITERATURE REQUESTS

Please contact your local distributor. Locate a local distributor contact, International Customer Service at +41 (0) 52 557 59 00 or 1.615.964.5672 (US).

Cardiovascular/Thoracic

Energy

Ear, Nose & Throat

General

Laparoscopic

Neurology

Obesity

OB/GYN

Ophthalmology

Orthopedics & Arthroscopy

Pediatrics

Rectal

Retractors

Spine

Urology

Sterilization Solutions

Alphabetical & Numeric Indexes

Approximators (Rib)



Bailey Rib Approximator

Sharp Teeth

CODE	DESCRIPTION	LENGTH	CODE	DESCRIPTION	LENGTH
54-2530	Pediatric	5 $\frac{3}{4}$ in 146 mm	54-2540	Adult	6 $\frac{3}{4}$ in 171 mm



Bailey-Gibbon Rib Approximator

Sharp Teeth

CODE	DESCRIPTION	LENGTH
54-2550S	With Extended 3-Prong Blades	6 $\frac{3}{4}$ in 171 mm



Bailey-Gibbon Rib Approximator

Ratchet Action, Extended Blades, Blunt

CODE	BLADE LENGTH	TOTAL OPENING	LENGTH
50-8055	1 $\frac{3}{4}$ in 44 mm	4 $\frac{5}{8}$ in 117 mm	7 $\frac{1}{8}$ in 181 mm

Questions? Contact us at customerservice@symmetryurgical.com
or learn more at symmetryurgical.com

Cannulas (I.M.A.)

Heparin I.M.A. Cannula

CODE	DESCRIPTION	LENGTH
54-5998	1.5 mm	2 1/8 in 54 mm



Clamps (Abdominal Aorta)

DeBakey Abdominal Aorta Clamp

DeBakey Teeth

CODE	TEETH	JAWS	LENGTH
55-6059	2x3	55 mm	10 1/2 in 267 mm
55-6060	1x2	50 mm	9 in 229 mm

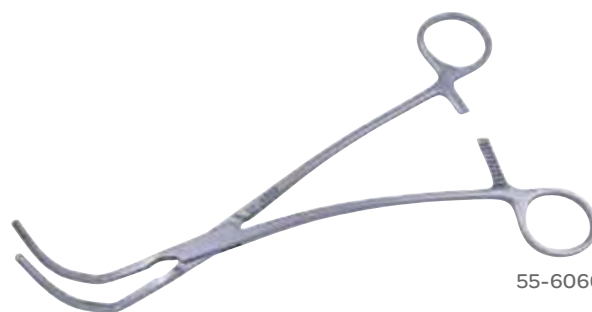

Zanger Abdominal Aorta Clamp

DeBakey Teeth

CODE	DESCRIPTION	LENGTH
55-6114	Curved Shanks	9 in 229 mm
55-6115	Curved Shanks	9 1/2 in 241 mm
55-6116	Curved Shanks	12 1/4 in 311 mm
55-6129	Shanks Angled 90°	9 1/2 in 241 mm
55-6128	Shanks Angled 90°	12 1/4 in 311 mm

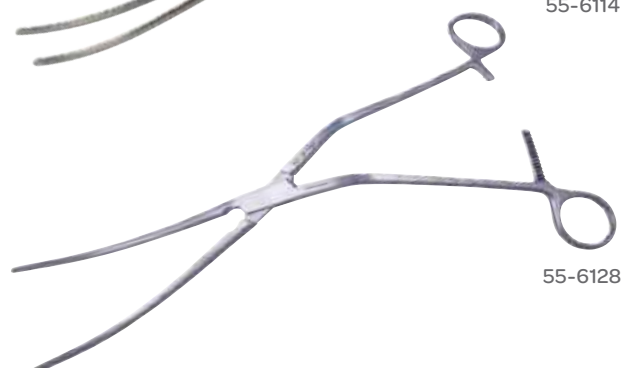

Clamps (Abdominal Aortic Aneurysm)

Grant Abdominal Aortic Aneurysm Clamp

2 x 3 DeBakey Jaws

CODE	JAW LENGTH	LENGTH
55-6139	45 mm	9½ in 241 mm
55-6124	65 mm	10½ in 267 mm

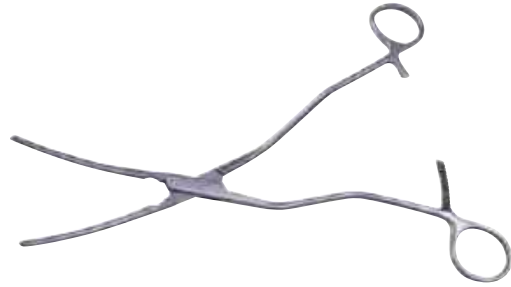

55-6139

Clamps (Acutely)

Cooley Classic® Acutely Curved Clamp

Curved Blades Calibrated at 5.0 mm Intervals, 2 x 2 Vascular Teeth

CODE	DESCRIPTION	JAW LENGTH	JAW DEPTH	LENGTH
37-1310	Medium	1¼ in 38 mm	⅝ in 15 mm	6½ in 165 mm
37-1311	Large	1¾ in 45 mm	¾ in 20 mm	6⅞ in 174 mm



37-1310

Clamps (Acutely Angled Aortic Aneurysm)

Howard Acutely Angled Aortic Aneurysm Clamp

Shanks Angled 90°, DeBakey Jaw

CODE	TEETH	JAW	LENGTH
55-6061	1 x 2 Teeth	105 mm	11¾ in 298 mm
55-6062	2 x 3 Teeth	105 mm	11¾ in 298 mm



55-6061

Questions? Contact us at customerservice@symmetrysurgical.com
or learn more at symmetrysurgical.com

Clamps (Acutely Curved)

Cooley Acutely Curved Clamp

Angled Shanks, Jaws Calibrated at 5.0 mm Intervals

CODE	DESCRIPTION	LENGTH
55-5023	Small Jaws	6½ in 165 mm

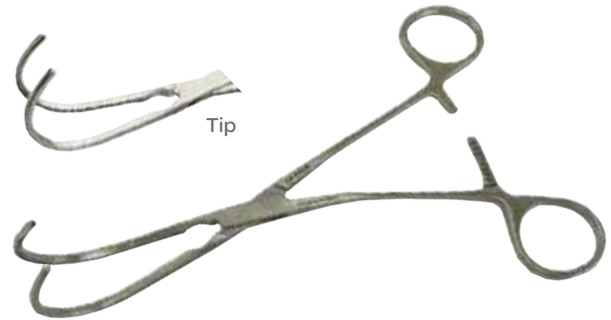

DeBakey Acutely Curved Clamp

CODE	DESCRIPTION	LENGTH
55-6031	Small Jaw	9⅝ in 244 mm
55-6032	Large Jaw	10 in 254 mm



55-6031

Clamps (Anastomosis)

Anastomosis Clamp

Titanium, Angled Shanks

CODE	DESCRIPTION	LENGTH
55-5020T	Angled Jaws	6¼ in 159 mm



Clamps (Anastomosis)

Anastomosis Classic® Clamp

Blades Calibrated at 5.0 mm Intervals, 2 x 2 Vascular Teeth

CODE	JAW LENGTH	JAW DEPTH	LENGTH
37-1225	1 $\frac{5}{8}$ in 41 mm	$\frac{3}{4}$ in 19 mm	6 $\frac{1}{2}$ in 165 mm



Bartley Classic® Anastomosis Clamp

Blades Calibrated at 5.0 mm Intervals, 2 x 2 Vascular Teeth

CODE	JAW LENGTH	JAW DEPTH	LENGTH
37-1305	1 in 25 mm	$\frac{1}{2}$ in 13 mm	5 $\frac{1}{2}$ in 140 mm



Castaneda Anastomosis Clamp

CODE	JAW LENGTH	JAW DEPTH	LENGTH
30-9003	$\frac{5}{8}$ in 16 mm	$\frac{1}{5}$ in 5.0 mm	6 in 152 mm
30-9004	$\frac{3}{4}$ in 19 mm	$\frac{1}{4}$ in 6.0 mm	6 in 152 mm
30-9005	$\frac{7}{8}$ in 22 mm	$\frac{1}{3}$ in 8.0 mm	6 in 152 mm



30-9003

Questions? Contact us at customerservice@symmetrysurgical.com
or learn more at symmetrysurgical.com

Clamps (Anastomosis)

Cooley Anastomosis Clamp

Jaws Calibrated at 5.0 mm Intervals

CODE	DESCRIPTION	LENGTH
55-6009	Standard Jaw	6 ½ in 165 mm
55-6011	Slender Jaw	6 ½ in 165 mm



55-6011

Cooley Classic® Anastomosis Clamp

Modified, 30° Side Angle, Blades Calibrated at 5.0 mm Intervals, 2 x 2 Vascular Teeth

CODE	JAW LENGTH	JAW DEPTH	LENGTH
37-1230	¾ in 19 mm	¼ in 6.0 mm	6 ½ in 165 mm



Cooley Opti-Length® Anastomosis Clamp

CODE	DESCRIPTION	LENGTH
67-7564	Anastomosis Clamp	12 in 305 mm

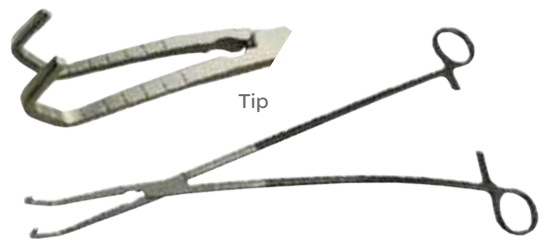

Tip

Cooley-Derra Anastomosis Clamp

CODE	DESCRIPTION	LENGTH
55-6001	Small Jaws	6 ½ in 165 mm
55-6002	Medium Jaws	6 ½ in 165 mm



55-6002

Clamps (Vascular)

Cooley-Derra Classic® Anastomosis Clamp

Blades Calibrated at 5.0 mm Intervals, Slightly Curved Shafts, 2 x 2 Vascular Teeth

CODE	JAW LENGTH	JAW DEPTH	LENGTH
37-1302	1 ³ / ₄ in 44 mm	½ in 13 mm	7 in 178 mm

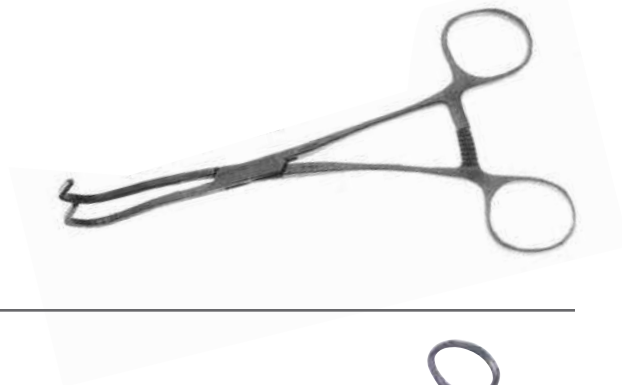

DeBakey-Derra Anastomosis Clamp

CODE	DESCRIPTION	LENGTH
55-6004	Small Jaws	6½ in 165 mm



Derra Anastomosis Clamp

1 x 2 Vascular Teeth

CODE	JAW LENGTH	JAW DEPTH	LENGTH
37-1221	1 in 25 mm	½ in 13 mm	6½ in 165 mm
37-1222	1 in 25 mm	½ in 13 mm	6¾ in 171 mm



37-1221

DeBakey Aneurysm Clamp

1 x 2 Vascular Teeth

CODE	JAW LENGTH	LENGTH
37-1141	3 ³ / ₈ in 86 mm	10½ in 267 mm
37-1142	4 in 102 mm	12 in 305 mm
37-1143	4¾ in 121 mm	12½ in 318 mm



37-1141

Questions? Contact us at customerservice@symmetrysurgical.com
or learn more at symmetrysurgical.com

Clamps (Aorta)

DeBakey-Bahnson Aorta Clamp

CODE	DESCRIPTION	LENGTH
55-6122	Slight Curve	10 in 254 mm



Beck Aorta Clamp

CODE	DESCRIPTION	JAW
55-5998	Aorta Clamp	1 1/8 in 29 mm



Cooley Aorta Clamp

CODE	DESCRIPTION	LENGTH
55-6064T	Titanium, Jaws 72 mm, 18 mm Deep	10 3/4 in 273 mm
37-1400	1 x 2 Vascular Teeth, Jaw Length 2 2/7 in (73 mm), Jaw Depth 1 1/16 in (27 mm)	10 1/2 in 267 mm



Cooley Aorta Aneurysm Clamp

CODE	DESCRIPTION	LENGTH
55-6008	Slightly Curved Jaws	10 3/4 in 273 mm



Clamps (Aorta)

DeBakey Aorta Exclusion Clamp

Acute S-Shape, 1 x 2 Vascular Teeth

CODE	JAW LENGTH		LENGTH	
37-1120	3 in	76 mm	7½ in	191 mm



DeBakey Aorta Aneurysm Clamp

CODE	TEETH	JAW LENGTH		LENGTH	
37-1140	1x2 Vascular Teeth	3 in	76 mm	9 in	229 mm
55-6055	2x3 DeBakey Teeth	4 in	102 mm	12 in	305 mm



37-1140

DeBakey-Bahnon Aorta Clamp

CODE	DESCRIPTION	LENGTH	
55-6121	Medium Curve	9½ in	241 mm



Diethrich Aorta Clamp

CODE	JAW LENGTH		JAW DEPTH	LENGTH
37-1015	1¾ in	44 mm	5⁄8 in 16 mm	8¾ in 213 mm



Clamps (Aorta)

Howard Aorta Aneurysm Clamp

Reverse Curve Shanks, 1 x 2 Teeth, DeBakey Jaw

CODE	TEETH	JAW	LENGTH
55-6057	1 x 2 Teeth	105 mm	11 ³ / ₄ in 298 mm



Kay Aorta Anastomosis Clamp

CODE	TEETH	JAW (W X D)	LENGTH
55-6065	DeBakey Teeth	45 x 32 mm	8 in 203 mm



Lambert-Kay Aorta Clamp

1 x 2 Vascular Teeth

CODE	JAW LENGTH	JAW DEPTH	LENGTH
37-1025	2 in 51 mm	³ / ₄ in 19 mm	7 ³ / ₄ in 197 mm



Mattox Aorta Clamp

1 x 2 Vascular Teeth, Angled Handles

CODE	JAW LENGTH	LENGTH
37-1021	3 in 76 mm	8 ³ / ₄ in 222 mm



Clamps (Aorta)

Mitchell Aorta Clamp

CODE	JAW	LENGTH
55-6113	25 mm	8 in 203 mm



Morris Aorta Clamp

2x3 Vascular Teeth

CODE	JAW LENGTH	LENGTH
37-1700	3 in 76 mm	7 ³ / ₄ in 197 mm
37-1701	3 in 76 mm	10 ³ / ₈ in 264 mm



Ochsner Aorta Clamp

1x2 Vascular Teeth

CODE	JAW LENGTH	JAW DEPTH	LENGTH
37-1026	2 ¹ / ₈ in 54 mm	³ / ₄ in 19 mm	10 ³ / ₈ in 264 mm



Parsonnet Aorta Clamp

CODE	JAW LENGTH	LENGTH
55-6145	1 ¹ / ₄ in 32 mm	10 ¹ / ₄ in 260 mm

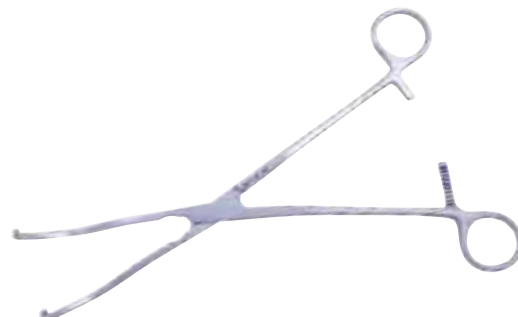

Clamps (Aorta)

Reul Aorta Clamp

2 x 3 Vascular Teeth

CODE	JAW LENGTH	JAW DEPTH	LENGTH
37-1024	2 1/8 in 54 mm	5/8 in 16 mm	10 in 254 mm



Strong Aortic Clamp

DeBakey Teeth

CODE	DESCRIPTION	JAWS (W X D)	LENGTH
55-6110	Angled	41 x 16 mm	8 in 203 mm
55-6108	Straight	41 x 16 mm	8 in 203 mm



55-6110

Beck Miniature Aorta Clamp

Straight Shanks

CODE	DESCRIPTION	LENGTH
55-5038	DeBakey Jaws	6 3/4 in 171 mm



Subramanian Mini Aorta Clamp

CODE	DESCRIPTION	LENGTH
55-5035	Mini Aorta Clamp	5 1/2 in 140 mm



Clamps (Approximator)



B-2AB

Approximator Clamp

For Thick Walled Arteries (Sold In Pairs Only)

CODE	DESCRIPTION	VESSEL DIAMETER	CODE	DESCRIPTION	VESSEL DIAMETER
B-1A	Single Clamp	0.4–1.0 mm	B-1AB	Black Single Clamp	0.4–1.0 mm
B-2A	Single Clamp	0.6–1.5 mm	B-2AB	Black Single Clamp	0.6–1.5 mm
B-3A	Single Clamp	1.0–2.25 mm	B-3AB	Black Single Clamp	1.0–2.25 mm



BB-1A

Approximator Clamp

With Frames, For Thick Walled Arteries

CODE	DESCRIPTION	VESSEL DIAMETER	CODE	DESCRIPTION	VESSEL DIAMETER
BB-1A	Double Clamp	0.4–1.0 mm	BB-1AB	Black Double Clamp	0.4–1.0 mm
BB-2A	Double Clamp	0.6–1.5 mm	BB-2AB	Black Double Clamp	0.6–1.5 mm
BB-3A	Double Clamp	1.0–2.25 mm	BB-3AB	Black Double Clamp	1.0–2.25 mm



ABB-11A

Approximator Clamp

Without Frames, for Thick Walled Arteries

CODE	DESCRIPTION	VESSEL DIAMETER	CODE	DESCRIPTION	VESSEL DIAMETER
ABB-11A	Double Clamp	0.4–1.0 mm	ABB-11AB	Black Double Clamp	0.4–1.0 mm
ABB-22A	Double Clamp	0.6–1.5 mm	ABB-22AB	Black Double Clamp	0.6–1.5 mm
ABB-33A	Double Clamp	1.0–2.25 mm	ABB-33AB	Black Double Clamp	1.0–2.25 mm

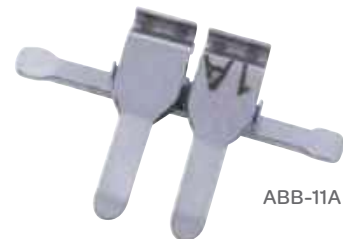
Clamps (Approximator)

Clamp Applying Forceps

Without Lock, 5 ½ in (140 mm)

CODE	DESCRIPTION	CODE	DESCRIPTION
78-0095	For Clamp Sizes B-1,B-2	78-0096	For Clamp Sizes B-3



Approximator Clamp

With Frames, for Thick Walled Arteries

CODE	DESCRIPTION	VESSEL DIAMETER	CODE	DESCRIPTION	VESSEL DIAMETER
ABB-1A	Double Clamp	0.4–1.0 mm	ABB-1AB	Black Double Clamp	0.4–1.0 mm
ABB-2A	Double Clamp	0.6–1.5 mm	ABB-2AB	Black Double Clamp	0.6–1.5 mm
ABB-3A	Double Clamp	1.0–2.25 mm	ABB-3AB	Black Double Clamp	1.0–2.25 mm



General Purpose Clamp, for Arteries & Veins

Sold In Pairs Only

Sold as Each

CODE	DESCRIPTION	VESSEL DIAMETER	CODE	DESCRIPTION	VESSEL DIAMETER
DC-1	Angled Clamps, Single Clamp	0.4–1.0 mm	BB-1V	Stationary, with Frame, Double Clamp	0.4–1.0 mm
DC-2	Angled Clamps, Single Clamp	0.6–1.5 mm	BB-2V	Stationary, with Frame, Double Clamp	0.6–1.5 mm
DC-3	Angled Clamps, Single Clamp	1.0–2.25 mm	BB-3V	Stationary, with Frame, Double Clamp	1.0–2.25 mm
B-1V	Single Clamps	0.4–1.0 mm			
B-2V	Single Clamps	0.6–1.5 mm			
B-3V	Single Clamps	1.0–2.25 mm			
B-1VB	Black Single Clamp	0.4–1.0 mm			
B-2VB	Black Single Clamp	0.6–1.5 mm			
B-3VB	Black Single Clamp	1.0–2.25 mm			

Clamps (Approximator)



ABB-3VB

Approximator Clamp

Stationary, with Frames

CODE	DESCRIPTION	VESSEL DIAMETER	CODE	DESCRIPTION	VESSEL DIAMETER
ABB-1V	Clamp	0.4–1.0 mm	ABB-1VB	Black Double Clamp	0.4–1.0 mm
ABB-2V	Clamp	0.6–1.5 mm	ABB-2VB	Black Double Clamp	0.6–1.5 mm
ABB-3V	Clamp	1.0–2.25 mm	ABB-3VB	Black Double Clamp	1.0–2.25 mm

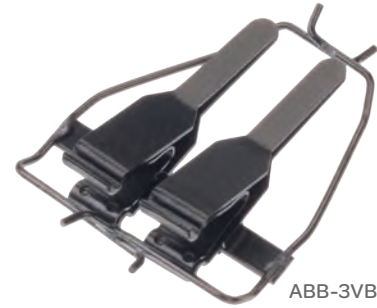

ABB-11VB

Approximator Clamp

Without Frames

CODE	DESCRIPTION	VESSEL DIAMETER	CODE	DESCRIPTION	VESSEL DIAMETER
ABB-11V	Double Clamp	0.4–1.0 mm	ABB-11VB	Black Double Clamp	0.4–1.0 mm
ABB-22V	Double Clamp	0.6–1.5 mm	ABB-22VB	Black Double Clamp	0.6–1.5 mm
ABB-33B	Double Clamp	1.0–2.25 mm	ABB-33VB	Black Double Clamp	1.0–2.25 mm



HD-S

Hand-Applied Approximator Clamp

With Flat Jaws

CODE	DESCRIPTION	VESSEL DIAMETER	CODE	DESCRIPTION	VESSEL DIAMETER
HD-S	Single	1.4–3.5 mm	HD-D	Double	1.4–3.5 mm
RD-S	Single	2.0–5.0 mm	RD-D	Double	2.0–5.0 mm
HD-SB	Black, Single	1.4–3.5 mm	HD-DB	Black, Double	1.4–3.5 mm
RD-SB	Black, Single	2.0–5.0 mm	RD-DB	Black, Double	2.0–5.0 mm

Clamps (Artery)

Dardick Artery Clamp

CODE	JAW LENGTH	LENGTH
55-8690	90°	5¼ in 133 mm



Clamps (Auricle)

Glover Classic® Auricle Appendage Clamp

1x2 Vascular Teeth

CODE	JAW LENGTH		JAW DEPTH		LENGTH
37-1105	2 in	51 mm	¼ in	6.0 mm	9¾ in 248 mm



Clamps (A-V Fistula)

Noon Classic® A-V Fistula Clamp

1x2 Vascular Teeth

CODE	JAW LENGTH		LENGTH
37-1335	1 in	25 mm	4½ in 114 mm



Clamps (Breast)

Adair Breast Clamp

CODE	DESCRIPTION	LENGTH
19-4004	Breast Clamp	7¾ in 197 mm



Clamps (Bronchus)

Lees Bronchus Clamp

CODE	DESCRIPTION	LENGTH
37-1035	1 x 2 Vascular Teeth, Jaw Length 1⅝ in (41 mm)	9½ in 241 mm
55-6600	Right Angle	8½ in 216 mm

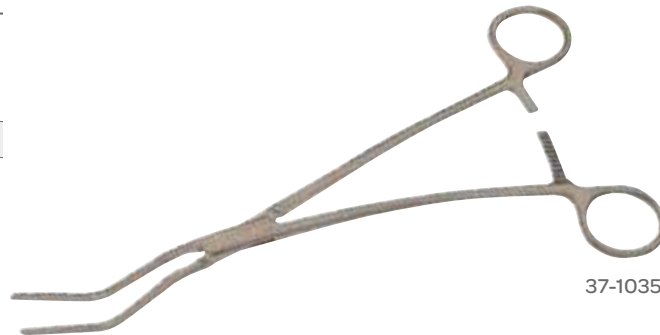

37-1035

Sarot Bronchus Clamp

Toothed Jaw, Left

CODE	JAW LENGTH	LENGTH
19-8167	1½ in 38 mm	9 in 229 mm



Clamps (Bulldog)

DeBakey Classic® Bulldog Clamp

1 x 2 Vascular Teeth, Ring Handle

CODE	ANGLE	JAW LENGTH		LENGTH	
37-1070	Straight	1 in	25 mm	5 3/8 in	137 mm
37-1071	Curved	1 1/2 in	38 mm	5 in	127 mm
37-1072	45°	1 5/8 in	41 mm	5 in	127 mm
37-1073	90°	1 5/8 in	41 mm	3 3/4 in	95 mm



37-1070

Glover Classic® Bulldog Clamp

Curved, 1 x 2 Vascular Teeth

CODE	JAW LENGTH		LENGTH	
37-1054	1 1/16 in	27 mm	2 1/2 in	64 mm
37-1055	1 in	25 mm	3 in	76 mm



37-1054

Gregory Classic® Bulldog Clamp

Straight, 1 x 2 Vascular Teeth, Tension 3.5 lbs, Short

CODE	JAW LENGTH		LENGTH	
37-1060	1 3/16 in	30 mm	3 1/2 in	89 mm



Cooley Bulldog Clamp

CODE	DESCRIPTION	JAW	LENGTH	
37-4024	Straight	20 mm	2 in	51 mm
55-4145	Straight	20 mm	2 in	51 mm
55-4146	Straight	30 mm	2 5/8 in	67 mm
55-4147	Straight	47 mm	3 3/8 in	86 mm
37-4025	Curved	18 mm	1 3/4 in	44 mm
55-4149	Curved	18 mm	1 3/4 in	44 mm
55-4150	Curved	24 mm	2 1/2 in	64 mm
55-4151	Curved	40 mm	3 1/8 in	79 mm



55-4145

Clamps (Bulldog)

DeBakey Bulldog Clamp

Cross-Action, 1 x 2 Vascular Teeth, Tension 6 lbs

CODE	DESCRIPTION	JAW LENGTH		LENGTH	
37-1040	Straight	$\frac{3}{4}$ in	19 mm	$3\frac{1}{8}$ in	79 mm
37-1044	Curved	$\frac{3}{4}$ in	19 mm	3 in	76 mm
37-1045	Curved	$1\frac{3}{16}$ in	30 mm	$3\frac{3}{8}$ in	86 mm
37-1046	Curved	$1\frac{3}{4}$ in	44 mm	$4\frac{1}{8}$ in	105 mm



37-1044

Diethrich Bulldog Clamp, Angled

Tension 55 gms

CODE	JAW LENGTH		LENGTH	
19-8090	$\frac{1}{2}$ in	13 mm	$1\frac{3}{4}$ in	44 mm
19-8091	$\frac{1}{2}$ in	13 mm	$1\frac{7}{8}$ in	48 mm
19-8095	$\frac{3}{4}$ in	19 mm	2 in	51 mm



19-8090

Diethrich Bulldog Clamp, Straight

Tension 55 gms

CODE	JAW LENGTH		LENGTH	
19-8092	$\frac{5}{8}$ in	15 mm	2 in	51 mm
19-8093	$\frac{3}{4}$ in	20 mm	$2\frac{1}{16}$ in	52 mm
19-8094	$\frac{3}{4}$ in	20 mm	$2\frac{1}{16}$ in	52 mm



19-8092

Diethrich Micro-Coronary Bulldog Clamp

CODE	ANGLE	JAW
55-4038	Angled	8.0 mm
55-4039	Angled	12 mm
55-4040	Angled	20 mm



55-4038

Clamps (Bulldog)

Diethrich Modified Tension Bulldog Clamp

Tension 180 gms

CODE	ANGLE	JAW LENGTH	LENGTH
19-8097	Angled	½ in 13 mm	1⅞ in 48 mm
19-8099	Straight	¾ in 19 mm	2⅞ in 54 mm



19-8097

Glover Bulldog Clamp

CODE	DESCRIPTION	LENGTH
55-6082	Angled	
37-1053	Straight, 1 x 2 Vascular Teeth, Jaw Length 2⅜ in (60 mm)	4½ in 114 mm



55-6082

Glover Bulldog Clamp

CODE	DESCRIPTION	JAW	LENGTH
55-4011	Straight	20 mm	2 in 51 mm
55-4012	Straight	30 mm	2½ in 64 mm
55-4013	Straight	40 mm	3½ in 89 mm
55-4015	Curved	20 mm	2 in 51 mm
55-4017	Curved	40 mm	3½ in 89 mm
55-4018	Curved	60 mm	4¾ in 121 mm



55-4015

Gregory Bulldog Clamp

CODE	DESCRIPTION	JAW	LENGTH
55-6191	Straight, Long	45 mm	4¼ in 108 mm
55-6149	Angled, Straight		4⅝ in 117 mm
55-6192	Angled, Short	30 mm	3½ in 89 mm
55-6149L	Curved Left		4¾ in 121 mm
55-6149R	Curved Right		4⅝ in 117 mm



55-6149

Clamps (Bulldog)

Gregory Internal Carotid Bulldog Clamp

CODE	JAW	LENGTH
55-6148	Long, 2 $\frac{3}{4}$ in (70 mm)	4 $\frac{3}{4}$ in 121 mm



Jacobson Bulldog Clamp

CODE	DESCRIPTION	SERRATED JAW	LENGTH
37-4022	Straight	13 mm	1 $\frac{3}{8}$ in 35 mm
37-4023	Straight	21 mm	1 $\frac{3}{4}$ in 44 mm
37-4026	Curved	13 mm	1 $\frac{1}{4}$ in 32 mm
37-4021	Curved	21 mm	1 $\frac{3}{4}$ in 44 mm



37-4022

Johns Hopkins Bulldog Clamp

CODE	DESCRIPTION	JAW LENGTH	LENGTH
55-4026	Straight		2 $\frac{1}{4}$ in 57 mm
55-4029	Straight		3 in 76 mm
55-4030	Straight		3 $\frac{1}{2}$ in 89 mm
55-4031	Curved		1 $\frac{1}{2}$ in 38 mm
55-4033	Curved		2 $\frac{1}{4}$ in 57 mm
19-8071	Straight, Serrated, Closing Pressure 6 lbs	$\frac{3}{4}$ in 19 mm	2 $\frac{1}{4}$ in 57 mm
19-8080	Curved, Serrated, Closing Pressure 6 lbs	$\frac{3}{8}$ in 10 mm	1 $\frac{1}{2}$ in 38 mm



19-8071

Senning Bulldog Clamp

CODE	DESCRIPTION
55-4054	Very Light, Adjustable Tension Cooley Jaws



Clamps (Bulldog)

Ultra™ Titanium Bulldog Vein Clamp

Lightweight, Corrosion Resistant Atraumatic Teeth, Slight Closing Pressure for Veins

CODE	DESCRIPTION	JAW LENGTH
15-0430	Straight	30 mm
15-0435	Straight	35 mm
15-0440	Straight	40 mm
15-0450	Straight	50 mm
15-0530	Light Curve	30 mm
15-0535	Light Curve	35 mm
15-0540	Light Curve	40 mm
15-0550	Light Curve	50 mm
15-0730	Strong Curve	30 mm
15-0735	Strong Curve	35 mm
15-0740	Strong Curve	40 mm
15-0750	Strong Curve	50 mm



15-0435

Ultra™ Titanium Bulldog Artery Clamp

Lightweight, Corrosion Resistant Atraumatic Teeth, Strong Closing Pressure for Arteries

CODE	DESCRIPTION	JAW LENGTH
15-0431	Straight	30 mm
15-0436	Straight	35 mm
15-0441	Straight	40 mm
15-0451	Straight	50 mm
15-0531	Light Curve	30 mm
15-0536	Light Curve	35 mm
15-0541	Light Curve	40 mm
15-0551	Light Curve	50 mm
15-0731	Strong Curve	30 mm
15-0736	Strong Curve	35 mm
15-0741	Strong Curve	40 mm
15-0751	Strong Curve	50 mm



15-0436

Ultra™ Light Bulldog Clamp

CODE	DESCRIPTION	JAW
55-9510	Angled	10 mm
55-9511	Angled	14 mm



55-9510

Clamps (Carotid)

Kartchner Carotid Clamp

Curved Shanks

CODE	DESCRIPTION	LENGTH	
55-5064	Long Thin Jaw	6 in	152 mm



Thompson Carotid Clamp

CODE	DESCRIPTION	LENGTH	
55-5063	Curved Shanks	6 in	152 mm

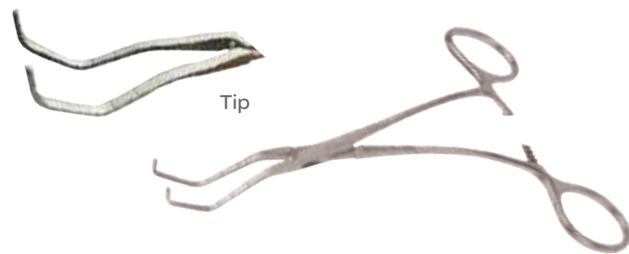

Clamps (Carotid Artery)

Javid Carotid Artery Clamp

CODE	DESCRIPTION	LENGTH	
55-7050	Large, Jaws Close to 6.0 mm Ring	7 1/8 in	181 mm
55-7051	Small, Jaws Close to a 4.0 mm Ring	6 3/4 in	171 mm



Clamps (Caval Occlusion)

Cooley Caval Occlusion Clamps

CODE	DESCRIPTION	LENGTH	
55-7028	24 French	8 1/4 in	210 mm
55-7029	26 French	8 1/4 in	210 mm
55-7033	34 French	8 1/4 in	210 mm

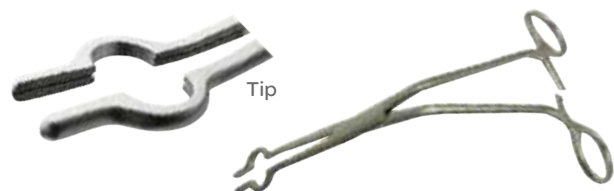

55-7033

Questions? Contact us at customerservice@symmetrysurgical.com
or learn more at symmetrysurgical.com

Clamps (Chest Tube Puller/Passer)

Chest Tube Puller/Passer

CODE	DESCRIPTION	LENGTH	
55-6926	With Ratchet	9 3/4 in	248 mm
55-6928	With Ratchet	14 in	356 mm
55-6925	Without Ratchet	9 3/4 in	248 mm
55-6927	Without Ratchet	14 in	356 mm



55-6925

Clamps (Coarctation)

Cooley Classic® Coarctation Clamp

2 x 2 Vascular Teeth, Calibrated

CODE	DESCRIPTION	SHAFT	JAW LENGTH		LENGTH	
37-1260	Straight Jaw	Straight Shaft	1 5/8 in	41 mm	6 3/4 in	171 mm
37-1262	Curved Jaw	Straight Shaft	1 5/8 in	41 mm	6 3/4 in	171 mm
37-1261	Straight Jaw	Angled Shaft	1 5/8 in	41 mm	6 3/4 in	171 mm



37-1260

Cooley Coarctation Clamp

CODE	DESCRIPTION	JAW LENGTH	LENGTH	
55-5011	Straight Shanks, Spoon Jaws	Jaws Calibrated at 5.0 mm Intervals	6 3/4 in	171 mm
55-6133	Straight	55 mm	8 3/4 in	222 mm
55-6134	Angled	55 mm	8 3/4 in	222 mm

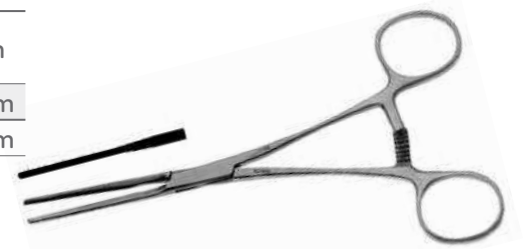

Crafoord Coarctation Clamp

1 x 2 Vascular Teeth

CODE	JAW LENGTH	LENGTH
19-8104	2 1/2 in 64 mm	9 1/2 in 241 mm



Clamps (Coarctation)

DeBakey Classic® Coarctation & Peripheral Vascular Clamp

Straight, 1 x 2 Vascular Teeth

CODE	JAW LENGTH	LENGTH
37-1150	2 1/8 in 54 mm	8 1/2 in 216 mm



DeBakey Coarctation Clamp

CODE	ANGLE	JAWS	LENGTH
55-6021	Angled	55 mm	9 in 229 mm

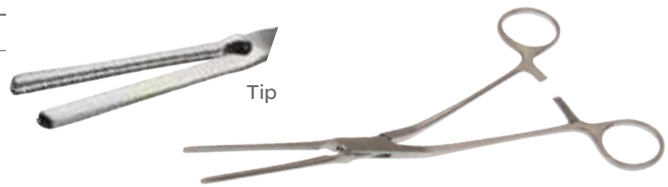

Glover Classic® Coarctation Clamp

Angular, 1 x 2 Vascular Teeth

CODE	JAW LENGTH	LENGTH
37-1091	2 1/8 in 54 mm	8 1/2 in 216 mm



Glover Coarctation Clamp

CODE	DESCRIPTION	LENGTH
55-6016	Straight, DeBakey Jaws	8 3/4 in 222 mm
55-6126	Straight	10 1/2 in 267 mm
55-6127	Angled, Straight Jaw	11 1/2 in 292 mm



55-6016

Questions? Contact us at customerservice@symmetrysurgical.com
or learn more at symmetrysurgical.com

Clamps (Coarctation)

Glover Opti-Length® Coarctation Clamp

CODE	DESCRIPTION	LENGTH	
67-7525	Straight	10 in	254 mm
67-7526	Curved	10 in	254 mm



67-7525

DeBakey Miniature Coarctation Clamp

CODE	DESCRIPTION	LENGTH	
55-5068	Straight Jaws	6 in	152 mm

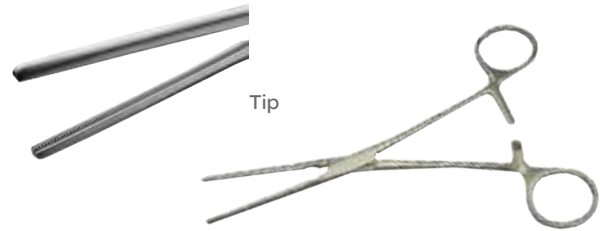

Tip

Clamps (Cross-Action Bulldog)

Cooley Cross-Action Bulldog Clamp

CODE	ANGLE	JAW	LENGTH	
55-4047	Straight	49 mm	4 ¼ in	108 mm
55-4048	Straight	68 mm	5 in	127 mm

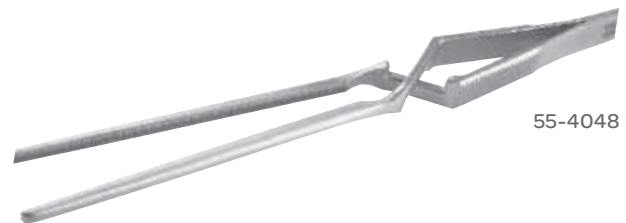

55-4048

DeBakey Cross-Action Bulldog Clamp

CODE	ANGLE	JAW	LENGTH	
55-4002	Straight	30 mm	3 ½ in	89 mm
55-4004	Straight	45 mm	4 in	102 mm
55-4006	Straight	60 mm	4 ¾ in	121 mm
55-4010	Curved	60 mm	4 ½ in	114 mm



55-4004

Clamps (Tangential)

DeBakey Tangential Clamp

CODE	JAW LENGTH	JAW DEPTH	LENGTH
37-1190	1 $\frac{5}{8}$ in 41mm	$\frac{1}{2}$ in 13mm	7 $\frac{1}{2}$ in 191mm



Clamps (Delicate)

Classic® Delicate Clamp

CODE	DESCRIPTION	LENGTH
30-4493	Right Angle	5 $\frac{1}{2}$ in 140mm
30-4494	Right Angle	7in 178mm



30-4493

Gemini Classic® Delicate Clamp

CODE	DESCRIPTION	LENGTH
19-5579	Curved	5 $\frac{1}{2}$ in 140mm



Bozeman Dressing Forceps

CODE	DESCRIPTION	LENGTH
19-8026	Straight	10 $\frac{3}{4}$ in 273mm



Questions? Contact us at customerservice@symmetrysurgical.com
or learn more at symmetrysurgical.com

Clamps (Ductus)

Glover Ductus Clamp

CODE	DESCRIPTION	LENGTH	
37-1086	Angled	8 in	203 mm



Clamps (Femoral Popliteal)

Dale Femoral Popliteal Clamp

CODE	DESCRIPTION	LENGTH	
55-6099	Small	6 3/4 in	171 mm
55-6101	Large	7 1/4 in	184 mm



55-6099

Clamps (Hemagrip)

"Fogarty® Style" Hemagrip Clamp

CODE	DESCRIPTION	JAW	LENGTH	
55-7525	Angled	33 mm	4 5/8 in	117 mm
55-7545	Angled	61 mm	8 1/2 in	216 mm
55-7540	Angled	61 mm	8 3/4 in	222 mm
55-7550	Angled	86 mm	9 1/4 in	235 mm



55-7525

Clamps (Hemagrip)

"Fogarty® Style" Hemagrip Clamp

CODE	ANGLE	JAW	LENGTH
55-7520	Straight	33 mm	6½ in 165 mm
55-7530	Straight	61 mm	11½ in 292 mm
55-7555	Straight	86 mm	10¼ in 260 mm



55-7520

Clamps (Hemostatic)

Gemini Forceps

Delicate Jaws

CODE	ANGLE	LENGTH
54-7255	Full Curve	5½ in 140 mm
54-7256	Full Curve	7¼ in 184 mm
54-7257	Full Curve	8¼ in 210 mm
54-7258	Full Curve	9 in 229 mm
54-7259	Full Curve	11¼ in 286 mm



54-7255

Gemini Classic® Delicate Clamp

CODE	DESCRIPTION	LENGTH
30-4492	80° Angle	7¼ in 184 mm



Questions? Contact us at customerservice@symmetrysurgical.com
or learn more at symmetrysurgical.com

Clamps (Hemostatic)

Gemini Hemostatic Clamp

CODE	DESCRIPTION	LENGTH	
19-5580	Curved	7 in	178 mm
19-5581	Curved	8 in	203 mm
19-5582	Curved	9 in	229 mm
19-5583	Curved	10 in	254 mm



19-5580

Wylie "J" Clamp

CODE	JAWS (W X D)	LENGTH	
55-6072	33 x 25 mm	8 ½ in	216 mm
55-6272	Acutely Curved	9 ⅝ in	244 mm



55-6072

Clamps (Hinge)

Verity™ Hinge Clamp

CODE	DESCRIPTION
50-1453	Hinge Clamp



Clamps (Hypogastric)

Wylie Hypogastric Clamp

Angled Shanks

CODE	DESCRIPTION	LENGTH	
55-6102	Curved Jaws	9 ½ in	241 mm



Clamps (Iliac)

Cooley Classic® Iliac Clamp

Angled Shaft, 2 x 2 Vascular Teeth

CODE	JAW LENGTH	LENGTH
37-1402	2 ³ / ₈ in 60 mm	8 ¹ / ₂ in 216 mm



Cooley Iliac Clamp

CODE	JAW LENGTH	LENGTH
37-1401	2 ³ / ₈ in 60 mm	10 in 254 mm



Opti-Length® Iliac Clamp

Angle, 2 x 2 Vascular Teeth

CODE	JAW LENGTH	LENGTH
67-7533	2 ³ / ₈ in 60 mm	12 in 305 mm



Clamps (Femoral Popliteal Anastomosis)

Dale Femoral Popliteal Anastomosis Clamp

CODE	DESCRIPTION	LENGTH
55-6098	DeBakey Jaws	7 ¹ / ₄ in 184 mm



Clamps (Instrument Kit)



Castaneda Instrument Kit

Width 7 in (178 mm), Depth 2 in (51 mm)

CODE	DESCRIPTION	LENGTH	
30-9025	Kit Includes the Following:	11 in	279 mm
30-9000	Multi-Purpose Clamp, Angled 30°		
30-9001	Multi-Purpose Clamp, Angled 50°		
30-9002	Partial Occlusion Clamp, Spoon Shape		
30-9003	Anastomosis Clamp, Small		
30-9004	Anastomosis Clamp, Medium		
30-9005	Anastomosis Clamp, Large, Castaneda Retractors	4 5/16 in	110 mm
50-8060	Sternal Retractor, Small		
50-8061	Sternal Retractor, Large		
30-8500	Vascular Forceps, Titanium, 2/Each	6 in	152 mm
19-8150	Mixer Clamp, Smooth Jaw	5 1/4 in	133 mm

Clamps (Intestinal)

Doyen Vascular Intestinal Clamp

2 x 3 Vascular Teeth

CODE	TEETH	JAW LENGTH		LENGTH	
37-1600	Straight	3 3/4 in	95 mm	9 in	229 mm
37-1601	Curved	3 3/4 in	95 mm	9 in	229 mm



37-1600

Clamps (Ligature Carrier)

Favaloro-Semb Ligature Carrier

CODE	DESCRIPTION	LENGTH
55-6040FC	Full Curved	11 in 279 mm



DeBakey-Semb Classic® Ligature Carrying Forceps

Length of Serrations $\frac{5}{8}$ in (16 mm), 1 x 2 Vascular Teeth

CODE	JAW LENGTH	LENGTH
37-1132	2¼ in 57 mm	10 in 254 mm



DeBakey-Semb Opti-Length® Ligature Carrying Forceps

CODE	DESCRIPTION	LENGTH
67-7534	Carrying Forceps	11 in 279 mm
67-7535	Carrying Forceps	12 in 305 mm



65-7534

Clamps (Liver)

Masters-Schwartz Liver Clamp

CODE	JAW WIDTH	LENGTH
19-4063	½ in 13 mm	7½ in 191 mm



Clamps (Micro-Coronary Bulldog)

Jacobson Micro-Coronary Bulldog Clamp

Adjustable Tension

CODE	ANGLE	JAW	LENGTH
55-4060	Straight	21 mm	1 7/8 in 48 mm



Clamps (Vascular)

Gregory Miniature Vascular Clamp

CODE	DESCRIPTION	LENGTH
55-5047	Straight	4 1/2 in 114 mm
55-5048	Curved	4 1/2 in 114 mm



55-5047

Clamps (Thoracic)

Modified Collier Clamp

CODE	DESCRIPTION	LENGTH
30-8065	Curved	10 1/2 in 267 mm



Henly Classic® Modified Vascular Clamp

1 x 2 Vascular Teeth

CODE	JAW LENGTH	LENGTH
37-1275	3/4 in 19 mm	7 1/2 in 191 mm



Clamps (Neonatal)

Cooley Neonatal Clamp

1 x 2 Vascular Teeth

CODE	DESCRIPTION	LENGTH	
55-5065	Straight	5 in	127 mm
55-5066	Angled Shanks, Straight Jaw	5 in	127 mm
55-5067	Curved Shanks, Straight Jaw	5 in	127 mm
55-6140	Spoon Jaw	5 in	127 mm



55-6140

Cooley Neonatal Antastomosis Clamp

CODE	DESCRIPTION	LENGTH	
55-6142	Satinsky	5 in	127 mm



55-6142

Cooley Neonatal Carotid Clamp

CODE	LENGTH	
55-6143	5 in	127 mm

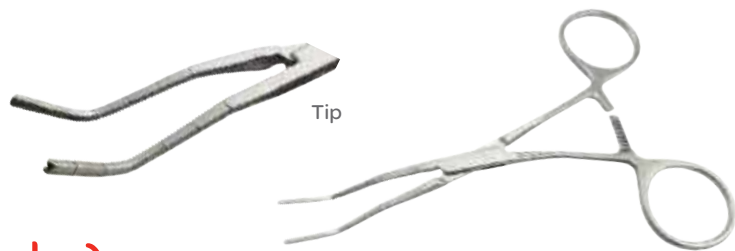

Clamps (Neonatal Vascular)

Neonatal Vascular Clamp

Calibrated Jaws 1.0 mm Wide, Horizontal Serrations

CODE	DESCRIPTION	LENGTH	
55-5040	Angled Jaws 30°	5 in	127 mm
55-5041	Angled Jaws 50°	5 in	127 mm
55-5042	Angled Jaws 90°	5 in	127 mm



55-5042

Questions? Contact us at customerservice@symmetrysurgical.com
or learn more at symmetrysurgical.com

Clamps (Occluding)

Cooley Atraumatic Clamp

CODE	DESCRIPTION	LENGTH
55-3925	Clamp	4 ¾ in 121 mm



Cooley Occlusion Clamp

Right Angle Jaw

CODE	SIZE	JAW	LENGTH
55-5075	Small	17 mm	5 ½ in 140 mm
55-5077	Large	35 mm	6 ½ in 165 mm



55-5077

Cooley Occlusion Clamp

Jaws 36 mm Long

CODE	DESCRIPTION	LENGTH
55-6138	Curved	8 ¼ in 210 mm

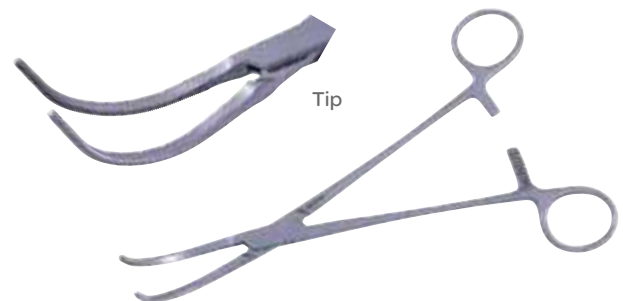

Clamps (Vascular)

Castaneda Partial Occlusion Clamp

Spoon Type

CODE	JAW LENGTH	JAW DEPTH	LENGTH
30-9002	1 $\frac{5}{16}$ in 33 mm	$\frac{5}{16}$ in 8.0 mm	4 $\frac{3}{4}$ in 121 mm



Cooley Partial Occlusion Clamp

CODE	WIDTH	DEPTH	LENGTH
55-6135	7.0 mm	23 mm	7 $\frac{3}{4}$ in 197 mm
55-6136	8.0 mm	35 mm	8 $\frac{1}{2}$ in 216 mm
55-6137	12 mm	52 mm	8 $\frac{1}{2}$ in 216 mm
55-6155	12 mm	60 mm	8 $\frac{1}{2}$ in 216 mm



55-6136

Clamps (Patent Ductus)

Cooley Classic® Patent Ductus Clamp

2 x 2 Vascular Teeth

CODE	SHAFT	JAW LENGTH	LENGTH
37-1250	Straight Shaft	1 $\frac{3}{16}$ in 30 mm	6 $\frac{1}{4}$ in 159 mm
37-1251	Angular Shaft	1 $\frac{3}{16}$ in 30 mm	6 $\frac{1}{4}$ in 159 mm



37-1250

Questions? Contact us at customerservice@symmetrysurgical.com
or learn more at symmetrysurgical.com

Clamps (Patent Ductus)

DeBakey Classic® Patent Ductus & Peripheral Vascular Clamp

1x2 Vascular Teeth

CODE	SHAFT	JAW LENGTH	LENGTH
37-1160	Straight Shaft	1 ³ / ₁₆ in 30 mm	7 ¹ / ₂ in 191 mm
37-1161	Angular Shaft	1 ³ / ₁₆ in 30 mm	7 ¹ / ₂ in 191 mm



37-1160

Cooley Patent Ductus Clamp

CODE	DESCRIPTION	JAW LENGTH	LENGTH
55-6132	Angled Shanks	30 mm	8 in 203 mm



Clamps (Pediatric)

Cooley Pediatric Clamp

CODE	DESCRIPTION	LENGTH
55-5002	Straight, Angled Jaw	5 ¹ / ₂ in 140 mm
55-5004	Straight, Spoon Jaw	5 ¹ / ₂ in 140 mm
55-5005	Angled, Straight Jaw	5 ¹ / ₂ in 140 mm



55-5002

DeBakey Pediatric Patent Ductus Clamp

CODE	DESCRIPTION	LENGTH
55-5051	Straight	6 ³ / ₄ in 171 mm
55-5052	Angled	6 ³ / ₄ in 171 mm
55-5053	Spoon Jaw	7 in 178 mm



55-5051

Clamps (Peripheral Blood Vessel)

Selman Peripheral Blood Vessel Clamp

CODE	DESCRIPTION	JAWS	LENGTH
55-6152	Straight	25 mm	5½ in 140 mm



Clamps (Peripheral Vascular)

DeBakey Classic® Peripheral Vascular Clamp

1 x 2 Vascular Teeth

CODE	DESCRIPTION	JAWS (L X D)	LENGTH
37-1110	Angled	2½ x 5/16 in 64 x 8.0 mm	7 in 178 mm
37-1125	Curved	1 5/8 x 5/16 in 41 x 8.0 mm	6½ in 165 mm
37-1115	S-Shaped	3 x 5/16 in 76 x 8.0 mm	8 in 203 mm



37-1110

Leland-Jones Classic® Peripheral Vascular Clamp

1 x 2 Vascular Teeth

CODE	ANGLE	JAW LENGTH	LENGTH
37-1080	15°	2 5/8 in 67 mm	7½ in 191 mm
37-1081	30°	2 5/8 in 67 mm	7½ in 191 mm



37-1080

Cooley Peripheral Vascular Clamp

CODE	JAWS	LENGTH
55-6580	Curved	6½ in 165 mm



55-6580

Clamps (Peripheral Vascular)

Cooley Peripheral Vascular Clamp

CODE	ANGLE	JAWS	LENGTH
55-6171	55°	35 mm	6½ in 165 mm
55-6172	55°	44 mm	6¾ in 171 mm
55-6174	55°	70 mm	7 in 178 mm
55-6173	55°	70 mm	7 in 178 mm

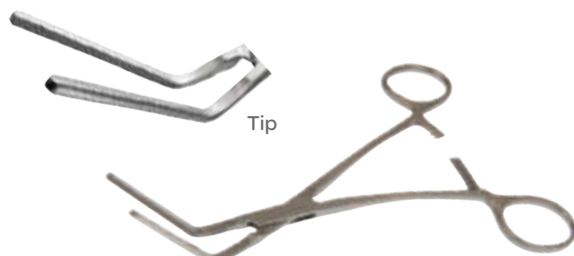

55-6172

Leland-Jones Peripheral Vascular Clamp

Straight Shanks

CODE	DESCRIPTION	LENGTH
55-6025	Straight	7½ in 191 mm
55-6026	15° Angle	7½ in 191 mm
55-6027	30° Angle	7½ in 191 mm



55-6027

Selman-Cooley Peripheral Vascular Clamp

CODE	ANGLE	JAW	LENGTH
55-6170	Curved	15 x 8.5 mm	5 in 127 mm



Clamps (Profunda)

Gregory Profunda Clamp

CODE	DESCRIPTION	LENGTH
55-6090	Extra Small Jaws	4⅞ in 124 mm
55-6091	Medium Jaws	7¼ in 184 mm
55-6092	Large Jaws	7¾ in 197 mm



55-3533

Clamps (Renal)

Cleveland Clinic Renal Clamp

CODE	DESCRIPTION	LENGTH	
55-3533	Small Jaw, Angled Left, Baby Clamp	5 ½ in	140 mm
55-3534	Small Jaw, Angled Right, Baby Clamp	6 ½ in	165 mm
55-3531	Large Jaw, Angled Left	9 ⅝ in	244 mm
55-3532	Large Jaw, Angled Right	9 ⅝ in	244 mm



Classic® Renal Artery Clamp

Blades Calibrated at 5.0 mm Intervals, Curved Shafts, 2 x 2 Vascular Teeth

CODE	JAW LENGTH		LENGTH	
37-1241	1 in	25 mm	7 ¼ in	195 mm



Cooley Renal Artery Clamp

CODE	LENGTH	
55-5057	7 ½ in	191 mm

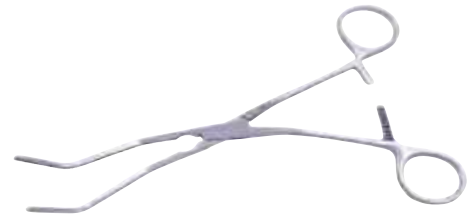

Renal Artery Clamp

2 x 2 Vascular Teeth

CODE	JAW LENGTH		LENGTH	
37-1242	1 in	25 mm	10 ⅝ in	270 mm



Questions? Contact us at customerservice@symmetrysurgical.com
or learn more at symmetrysurgical.com

Clamps (Ring Handle Bulldog)

DeBakey Ring Handle Bulldog Clamp

CODE	DESCRIPTION	JAW	LENGTH
55-4022	Straight Shanks, 90° Jaw	40 mm	4 ¾ in 121 mm
55-4019	Straight Shanks, Straight Jaw	45 mm	5 ⅛ in 130 mm
55-4020	Straight Shanks, Curved Jaw	45 mm	5 in 127 mm
55-4021	"S" Curved	45 mm	5 in 127 mm
55-4023	Curved Shanks, 45° Jaw		4 ¾ in 121 mm



55-4023

Stoney Spleno-Reno Shunt Clamp

CODE	DESCRIPTION	LENGTH
55-6095	Small	8 ¼ in 210 mm
55-6096	Medium	9 in 249 mm
55-6097	Large	9 ⅝ in 244 mm



55-6097

Clamps (Spoon-Shaped)

Glover Classic® Spoon-Shaped Clamp

1 x 2 Vascular Teeth

CODE	DESCRIPTION	JAW (L X D)	LENGTH
37-1101	Extra Long	2 ⅜ x ⅝ in 60 x 7.0 mm	10 in 254 mm
37-1100	Standard	1 ¾ x ⅝ in 44 x 8.0 mm	8 ½ in 216 mm



37-1101

Clamps (Wire Holding)

Rubio Classic Plus® Wire Holding Clamp

CODE	DESCRIPTION	LENGTH
36-2023	Tungsten Carbide Jaw Inserts	5 in 127 mm



Clamps (Stay Suture)

Gregory Stay Suture Clamp

Gold Band

CODE	DESCRIPTION	LENGTH	
19-8027	Large #2, Smooth Jaws	$\frac{3}{4}$ in	19 mm
19-8029	Large #4	$1\frac{5}{8}$ in	41 mm



19-8027

Clamps (Supraceliac)

Cherry Supraceliac Clamp

Shanks Curved 60°

CODE	DESCRIPTION	LENGTH	
55-6117	Curved Jaws	$12\frac{1}{2}$ in	318 mm



Clamps (Tangential Occlusion)

DeBakey Classic® Tangential Occlusion Clamp

1 x 2 Vascular Teeth

CODE	JAW LENGTH		JAW DEPTH		LENGTH	
37-1192	$2\frac{3}{8}$ in	60 mm	$\frac{5}{8}$ in	16 mm	10 in	254 mm
37-1193	$2\frac{3}{8}$ in	60 mm	$\frac{5}{8}$ in	16 mm	$10\frac{1}{4}$ in	260 mm



37-1192

Questions? Contact us at customerservice@symmetrysurgical.com
or learn more at symmetrysurgical.com

Clamps (Tangential Occlusion)

Cooley Tangential Occlusion Clamp

Double Angled Jaws Calibrated at 5.0 mm Intervals

CODE	DEPTH	WIDTH	LENGTH	
55-6570	6.0 mm	20 mm	7 ³ / ₄ in	197 mm
55-6572	7.0 mm	26 mm	8 ³ / ₄ in	222 mm
55-6574	10 mm	34 mm	9 ³ / ₄ in	248 mm



DeBakey Tangential Occlusion Clamp

CODE	LENGTH	DEPTH	LENGTH	
55-6044	48 mm	16 mm	9 ³ / ₄ in	248 mm
55-6047	75 mm	17 mm	11 in	279 mm

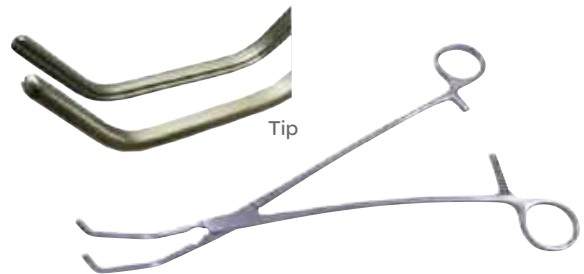

Clamps (Thoracic)

Castaneda-Mixer Thoracic Clamp

CODE	DESCRIPTION	LENGTH	
19-8150	Smooth Jaws	5 ¹ / ₄ in	133 mm



Harrington-Mixer Thoracic Clamp

Longitudinal Serrations with Cross-Serrated Tips

CODE	DESCRIPTION	LENGTH	
30-8051	Right Angled	12 ¹ / ₄ in	311 mm



Clamps (Thoracic)

Jones Thoracic Clamp

CODE	DESCRIPTION	LENGTH
19-8152	Curved	11¼ in 286 mm

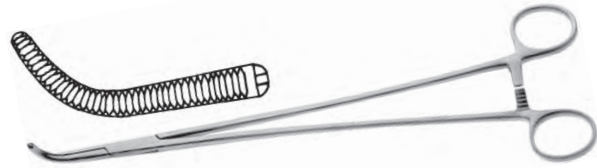

Mixer Thoracic Clamp

CODE	DESCRIPTION	LENGTH
19-8146	Angular, Soft Jaw, Cross-Serrated Tips	11 in 279 mm
19-8147	Angular, Standard Jaw	11 in 279 mm
19-8145	Curved, Cross-Serrations	9 in 229 mm



19-8145

DeBakey Thoracic Dissecting Forceps

CODE	DESCRIPTION	LENGTH
55-5070	"C" Curve	7½ in 191 mm
55-5072	"C" Curve	9 in 229 mm
55-5071	"D" Curve	7½ in 191 mm

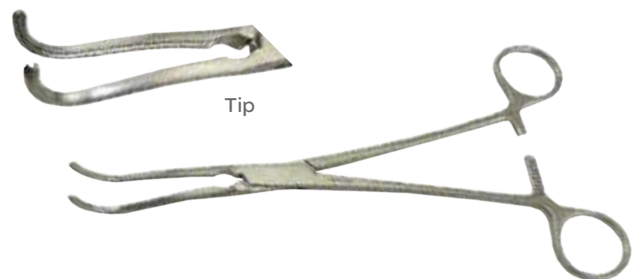

55-5070

Clamps (Tibial Artery)

Demos Tibial Artery Clamp

CODE	JAWS	LENGTH
55-6107	40 mm	8¼ in 210 mm

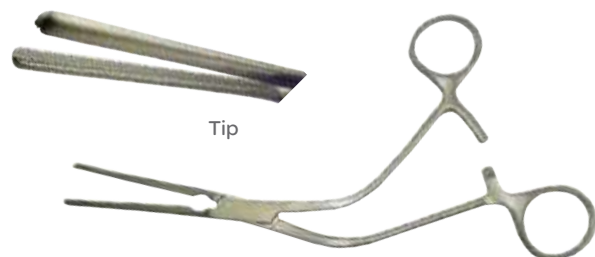

Questions? Contact us at customerservice@symmetrysurgical.com
or learn more at symmetrysurgical.com

Clamps (Tubing)

Tube Clamp Forceps

Cross-Hatched Jaws, Tubing Jaw Opening with Closed Ratchets $\frac{1}{8}$ in (3.0 mm)

CODE	DESCRIPTION	JAW LENGTH		LENGTH	
32-3514	Clamp Forceps	1 in	25 mm	6 $\frac{1}{2}$ in	165 mm



Tubing Clamp

Should Be Used with Tubing No Larger Than $\frac{1}{4}$ in (6.0 mm) Diameter

CODE	DESCRIPTION	JAW LENGTH		LENGTH	
19-8010		1 $\frac{5}{16}$ in	33 mm	7 $\frac{1}{2}$ in	191 mm
32-3514	With Guard, Tubing 22 mm			8 in	203 mm



19-8010

Clamps (Vascular)

Beck-Cooley Vascular Clamp

Jaws Calibrated at 5.0 mm Intervals, Cooley Jaws

CODE	DESCRIPTION	LENGTH	
55-5037	Medium Curve	6 in	152 mm



Clamps (Vascular)

Cooley Classic® Vascular Clamp

Blades Calibrated at 5.0 mm Intervals, 2 x 2 Vascular Teeth

CODE	ANGLE	JAWS (L X D)	LENGTH
37-1282	60°	1 x $\frac{5}{16}$ in 25 x 8.0 mm	6 $\frac{3}{4}$ in 171 mm
37-1280	90°	1 x $\frac{5}{16}$ in 25 x 8.0 mm	6 $\frac{1}{2}$ in 165 mm



37-1280

Cooley Vascular Clamp

Angled Shanks, Blades Calibrated at 5.0 mm Intervals

CODE	DESCRIPTION	LENGTH
55-5030	60°	6 $\frac{1}{2}$ in 165 mm
55-5027T	90°, Titanium	6 in 152 mm
55-5028	90°	6 $\frac{1}{2}$ in 165 mm



55-5028

DeBakey Opti-Length® Vascular Clamp

CODE	DESCRIPTION	LENGTH
67-7523	Vascular Clamp	9 in 229 mm
67-7524	Vascular Clamp	10 in 254 mm



67-7523

DeBakey Vascular Clamp

1 x 2 Vascular Teeth

CODE	DESCRIPTION	JAW	LENGTH
37-1130	Acutely Curved	2 x $\frac{3}{8}$ in 51 x 10 mm	9 $\frac{1}{2}$ in 241 mm

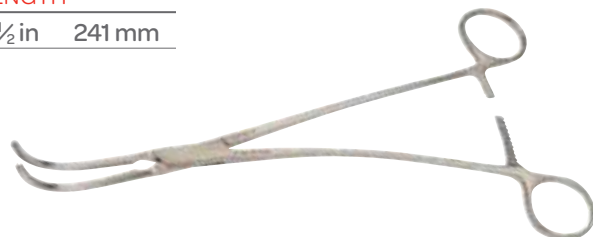

Clamps (Vascular)

Reynolds Classic® Vascular Clamp

1 x 2 Vascular Teeth

CODE	SIZE	JAW (L X D)		LENGTH	
37-1323	50° Angle	1 x $\frac{3}{16}$ in	25 x 5.0 mm	7 in	178 mm
37-1324	50° Angle	1 $\frac{3}{16}$ x $\frac{3}{16}$ in	30 x 5.0 mm	7 in	178 mm
37-1326	85° Angle	1 $\frac{3}{16}$ x $\frac{3}{16}$ in	30 x 5.0 mm	6 $\frac{1}{2}$ in	165 mm



37-1323

Reynolds Vascular Clamp

CODE	DESCRIPTION	JAWS	LENGTH
55-5033	DeBakey Teeth	85° Small	6 $\frac{3}{4}$ in 171 mm



Clamps (Vena Cava)

Satinsky Classic® Vena Cava Clamp

1 x 2 Vascular Teeth

CODE	SIZE	JAW (L X D)		LENGTH	
37-1202	Small	2 $\frac{1}{4}$ x $\frac{1}{4}$ in	57 x 6.0 mm	9 $\frac{1}{2}$ in	241 mm
37-1201	Medium	2 $\frac{1}{2}$ x $\frac{3}{8}$ in	64 x 10 mm	9 $\frac{1}{2}$ in	241 mm
37-1200	Large	2 $\frac{3}{4}$ x $\frac{1}{2}$ in	70 x 13 mm	9 $\frac{1}{2}$ in	241 mm

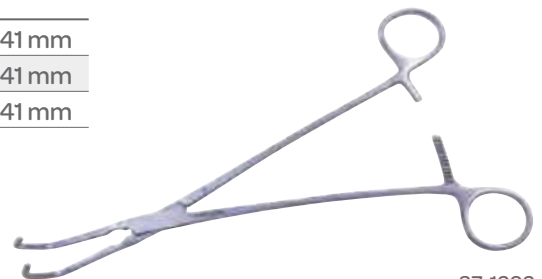

37-1202

Clamps (Vena Cava)

Satinsky Vena Cava Clamp

CODE	TEETH	JAWS (L X D)	LENGTH
55-6050	DeBakey Teeth	4.0 x 9.0 mm	10 in 254 mm



Clamps

Castaneda Clamp

CODE	DESCRIPTION	LENGTH
55-5841T	30° Angle, Titanium	4 ¼ in 108 mm
55-5842T	70° Angle, Titanium	4 ¼ in 108 mm
55-5843T	90° Angle, Titanium	4 ¼ in 108 mm
55-5085	Horizontal Serrations, Long Thin Calibrated, Spoon Jaw	5 in 127 mm



55-5841T

Castaneda Multi Purpose Clamp

CODE	ANGLE	JAW LENGTH	LENGTH
30-9000	30°	1 ⅜ in 35 mm	5 in 127 mm
30-9001	50°	1 ⅜ in 35 mm	5 in 127 mm
30-9006	90°	1 ⅜ in 35 mm	5 in 127 mm



30-9000

Clamps

Cooley Miniature Multi-Purpose Clamp

Jaws Calibrated at 5.0 mm Intervals

CODE	DESCRIPTION	LENGTH	
55-5019	30° Angle	6½ in	165 mm
55-5018	60° Angle	6 in	152 mm
55-5017	90° Angle	5½ in	140 mm



55-5019

Cooley Multi Purpose Clamp

CODE	ANGLE	JAW LENGTH		LENGTH	
37-1290	30°, 2x2 Vascular Teeth, Calibrated Jaws	1⅜ in	30 mm	6½ in	165 mm
37-1291	60°, 2x2 Vascular Teeth, Calibrated Jaws	1⅜ in	30 mm	6 in	152 mm
37-1292	90°, 2x2 Vascular Teeth, Calibrated Jaws	1⅜ in	30 mm	5½ in	140 mm
55-6161	Angled 60°	2⅛ in	54 mm	9 in	229 mm
55-6162	Angled 60°	2¾ in	70 mm	9½ in	241 mm



37-1291

Crile-Type Clamp

CODE	DESCRIPTION	JAW	LENGTH	
37-4037	Serrated Curved	1½ in 38 mm	7½ in	191 mm



Clamps (Multi-Purpose)



37-1321

DeBakey Multi Purpose Clamp

CODE	ANGLE	TEETH	JAW LENGTH		LENGTH	
37-1321	60°	1 x 2 Vascular Teeth	1 ³ / ₈ in	35 mm	6 in	152 mm
55-6038	60°	1 x 2 DeBakey Teeth	1 ¹ / ₂ in	38 mm	9 ¹ / ₄ in	235 mm
37-1171	60°	1 x 2 Vascular Teeth	2 in	51 mm	8 in	203 mm
37-1172	60°	1 x 2 Vascular Teeth	2 ³ / ₄ in	70 mm	9 ¹ / ₂ in	241 mm
55-6042	60°	1 x 2 DeBakey Teeth	4 in	102 mm	12 in	305 mm
37-1183	90°	1 x 2 Vascular Teeth	4 in	102 mm	10 ¹ / ₂ in	267 mm
55-6035	90°	1 x 2 DeBakey Teeth	2 in	51 mm	8 in	203 mm
55-6036	90°	1 x 2 DeBakey Teeth	3 in	76 mm	8 ¹ / ₂ in	216 mm
55-6034	90°	1 x 2 DeBakey Teeth	1 ¹ / ₂ in	38 mm	8 ³ / ₄ in	222 mm

DeBakey Castaneda Clamp

Long Serrated with Cross Serrated Tips

CODE	DESCRIPTION	LENGTH
55-4926	Anastomosis Jaws. #1	4 ¹ / ₄ in 108 mm
55-4929	Carotid Jaws	4 ¹ / ₄ in 108 mm
55-4932	"S" Curved	4 ¹ / ₄ in 108 mm



55-4929

DeBakey Multi-Purpose Peripheral Vascular Clamp

CODE	JAWS	LENGTH
55-6022	65 mm	7 in 178 mm



Questions? Contact us at customerservice@symmetrysurgical.com
or learn more at symmetrysurgical.com

Clamps

DeBakey-Cooley Clamp

Long Serrated with Cross Serrated Tips

CODE	DESCRIPTION	LENGTH	
55-6189	Slightly Curved Jaws	10 in	254 mm



37-1096



55-6077

Glover Clamp

CODE	DESCRIPTION	JAW (L X D)		LENGTH	
55-6077	Curved Right Angle, Long, DeBakey Teeth			8 in	203 mm
37-1096	Extra Long, Curved, 1 x 2 Vascular Teeth	2½ x ¾ in	64 x 10 mm	9½ in	241 mm
37-1097	Right Angle, Curved, 1 x 2 Vascular Teeth	1¾ x 1¾ in	44 x 44 mm	7⅛ in	181 mm
37-1095	Standard, Curved, 1 x 2 Vascular Teeth	2 x ¾ in	51 x 10 mm	8⅛ in	206 mm

Harken Auricle Clamp

CODE	DESCRIPTION	LENGTH	
55-5107	#1 Curve, Cross-Serrated Jaws	9¼ in	235 mm
55-6069	#2 Curve, DeBakey Teeth	10 in	254 mm
55-5108	#2 Curve, Cross-Serrated Jaws	9¼ in	235 mm
55-6071	#4 Curve, DeBakey Teeth	10 in	254 mm



55-6071

Hendren Clamp

Jaws Calibrated at 5.0 mm Intervals, Very Delicate Cooley Teeth

CODE	DESCRIPTION	LENGTH	
55-6540	6.0 mm Jaw Base	8¼ in	210 mm
55-6546	24 mm Jaw Base	8¼ in	210 mm



55-6546

Clamps

Pennington Clamp

CODE	JAWS	TIP WIDTH	LENGTH
19-4000	Triangular Jaws	$\frac{7}{16}$ in 11 mm	6 in 152 mm
19-4001	Triangular Jaws	$\frac{7}{16}$ in 11 mm	8 in 203 mm



19-4001

Vanderbilt Clamp

CODE	DESCRIPTION	LENGTH
54-5001	Curved, Horizontal Serrations	$8\frac{5}{8}$ in 219 mm



Containers

Bookwalter® I.M.A. Retractor Case

CODE	DESCRIPTION
50-4604	Storage



Bookwalter® Table Fixation & Ring Case

CODE	DESCRIPTION	LENGTH
50-4507	Table Fixation and Ring Case	2 3/4 in x 13 1/8 in x 22 1/8 in 95 x 333 x 562 mm



Cardiac Retractor Case

CODE	DESCRIPTION
87-0628	Retractor Case



Containers

Castaneda Instrument Case

CODE	WIDTH X DEPTH	LENGTH
21-8010	7x2in 178x51mm	11in 279mm



Diethrich Instrument Case

CODE	WIDTH X DEPTH	LENGTH
21-8000	6 ³ / ₄ x2in 171x51mm	10 ¹ / ₂ in 267mm



Dilator Case

CODE	DESCRIPTION	LENGTH
21-8005	Stainless Steel	9in 229mm



Questions? Contact us at customerservice@symmetrysurgical.com
or learn more at symmetrysurgical.com

Containers

I.M.A. Instrument Case

CODE	DESCRIPTION
80-1865	Two Level Storage

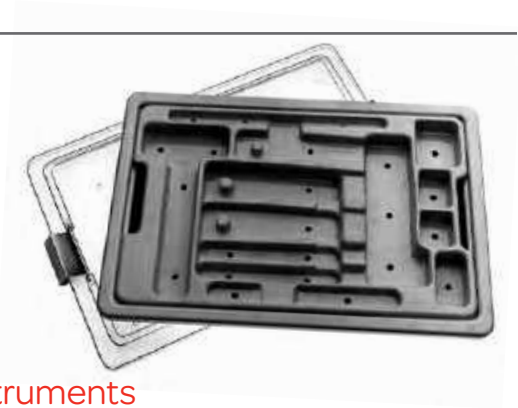

Instrument Case for Anterior Cervical Fusion Instruments

CODE	DESCRIPTION	LENGTH
21-1001	Instrument Case	9 in 229 mm



Microcare® Bayonet Case

Removable Lid

CODE	DESCRIPTION	LENGTH
80-1565	Large	15 in 381 mm
80-1564	Small	10 ½ in 267 mm



80-1565

Containers

Microcare® Case

CODE	DESCRIPTION	LENGTH	
80-1598	Small	11 in	279 mm
80-1599	Large	21 in	533 mm
80-1597	Medium	15 ½ in	394 mm



80-1597

Microcare® Combo Instrument Case

CODE	DESCRIPTION	LENGTH	
80-1567	Instrument Case	15 in	381 mm



Microcare® Flex Mat

CODE	DESCRIPTION	LENGTH	
80-1830	10 x 18 in 254 x 458 mm	18 in	458 mm

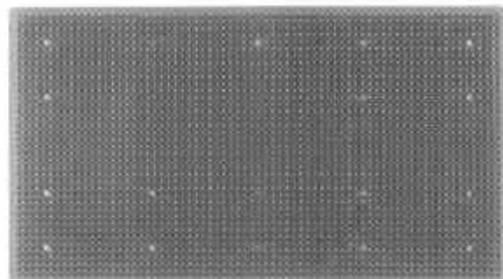

Questions? Contact us at customerservice@symmetrysurgical.com
or learn more at symmetrysurgical.com

Containers

Microcare® Instrument Case

CODE	DESCRIPTION	LENGTH
80-1563	Small	10 ½ in 267 mm
80-1562	Large	15 in 381 mm



Micropak Classic Series II

CODE	DESCRIPTION
0217	Base, Lid, Insert Tray and Mat

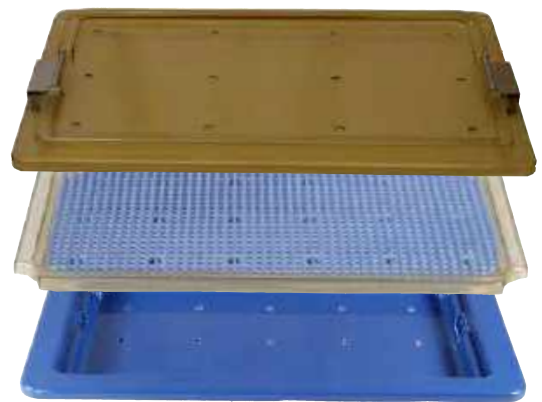

80-1563

Noon A-V Fistula Case

CODE	WIDTH X DEPTH	LENGTH
21-8015	9 ¾ x 2 in 248 x 51 mm	12 in 305 mm



Containers

Sterilizing Tray

Depth 3 in

CODE	DESCRIPTION	LENGTH
21-3000	Small	11 ¼ in 286 mm
21-3001	Medium	16 in 406 mm
21-3002	Large, Depth 3 in (76 mm)	21 ¾ in 552 mm



21-3000

Open End Instrument Stringers

Instrument Stringer, Open End, Special Sizes Available Upon Request

CODE	WIDTH	LENGTH
52-0006	2 ½ in 64 mm	6 in 152 mm
52-0006-3	3 in 76 mm	6 in 152 mm
52-0006-4	4 in 102 mm	6 in 152 mm
52-0006-6	6 in 152 mm	6 in 152 mm
52-0007	2 ½ in 64 mm	7 in 178 mm
52-0007-3	3 in 76 mm	7 in 178 mm
52-0008	2 ½ in 64 mm	8 in 203 mm
52-0008-3	3 in 76 mm	8 in 203 mm
52-0008-4	4 in 102 mm	8 in 203 mm
52-0008-5	5 in 127 mm	8 in 203 mm
52-0010	2 ½ in 64 mm	10 in 254 mm
52-0010-4	4 in 102 mm	10 in 254 mm
52-0010-5	5 in 127 mm	10 in 254 mm
52-0010-6	6 in 152 mm	10 in 254 mm
52-0012	2 ½ in 64 mm	12 in 305 mm
52-0012-3	3 in 76 mm	12 in 305 mm
52-0012-4	4 in 102 mm	12 in 305 mm
52-0012-6	6 in 152 mm	12 in 305 mm
52-0014	2 ½ in 64 mm	14 in 356 mm
52-0014-4	4 in 102 mm	14 in 356 mm
52-0014-6	6 in 152 mm	14 in 356 mm
52-0016	2 ½ in 64 mm	16 in 406 mm
52-0016-5	5 in 127 mm	16 in 406 mm
52-0018	2 ½ in 64 mm	18 in 458 mm
52-0018-3	3 in 76 mm	18 in 458 mm
52-0018-4	4 in 102 mm	18 in 458 mm



52-0008

Questions? Contact us at customerservice@symmetrysurgical.com
or learn more at symmetrysurgical.com

Containers

Weinstein Instrument Stringers

CODE	LENGTH	
51-0006W	6 in	152 mm
51-0008W	8 in	203 mm
51-0010W	10 in	254 mm
51-0012W	12 in	305 mm
51-0014W	14 in	356 mm



51-0006W

Instrument Stringers with Round Bar

CODE	DESCRIPTION	LENGTH	
51-0006	Stringers with Round Bar	6 in	152 mm
51-0008	Stringers with Round Bar	8 in	203 mm
51-0010	Stringers with Round Bar	10 in	254 mm
51-0012	Stringers with Round Bar	12 in	305 mm
51-0014	Stringers with Round Bar	14 in	356 mm
51-0016	Stringers with Round Bar	16 in	406 mm



51-0006

Instrument Stringer with Ball Closure

CODE	DESCRIPTION	LENGTH	
51-0006B	Stringer with Ball Closure	6 in	152 mm
51-0008B	Stringer with Ball Closure	8 in	203 mm
51-0010B	Stringer with Ball Closure	10 in	254 mm
51-0012B	Stringer with Ball Closure	12 in	305 mm



51-0006B

Mayo Bunt Instrument Holder

CODE	DESCRIPTION	LENGTH	
46-2810	Instrument Holder	5½ in	140 mm



Containers

Saunders Instrument Holder

CODE	DESCRIPTION
46-1780	Instrument Holder

*instrument not included



Instrument Stringer with Middle Lock

CODE	WIDTH	LENGTH
50-0006	2½ in 64 mm	6 in 152 mm
50-0008	2½ in 64 mm	8 in 203 mm
50-0010	2½ in 64 mm	10 in 254 mm
50-0012	2½ in 64 mm	12 in 305 mm
50-0014	2½ in 64 mm	14 in 356 mm
50-0016	2½ in 64 mm	16 in 406 mm
50-0018	2½ in 64 mm	18 in 458 mm

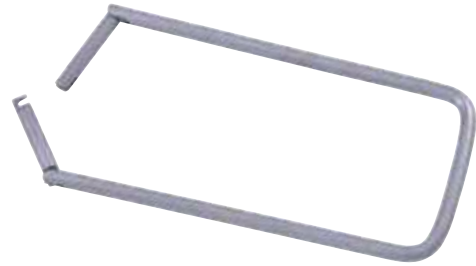

50-0006

Wire Instrument Rack

CODE	HEIGHT	LENGTH
21-4002	3¼ in 83 mm	4¼ in 108 mm



Wire Mesh Bur Holder

CODE	DESCRIPTION	LENGTH
79-0003	Small	1⅜ in 35 mm
79-0004	Large	2⅜ in 54 mm



79-0004

Containers

Clamp Box

Perforated with Sliding Lide

CODE	DESCRIPTION	
46-3746	2 x 1 x $\frac{3}{16}$ in	51 x 25 x 5.0 mm
46-3747	2 $\frac{1}{2}$ x 1 $\frac{5}{8}$ x $\frac{1}{4}$ in	64 x 41 x 6.0 mm
46-3748	3 x 1 x $\frac{3}{16}$ in	76 x 25 x 5.0 mm



46-3746

Cords

Air Hose

For use with 26-7006, 26-5000 and 26-5001.

CODE	DESCRIPTION	LENGTH
26-5007	Air Hose	10 ft 3 m



Cups

Iodine Cup

CODE	DESCRIPTION	LENGTH
32-3311	6 oz 177ml	3 x 2 in 76 x 51 mm



Cups

Medicine Cup

CODE	DESCRIPTION	LENGTH
32-3310	2 oz 59 ml	2 x 2 in 51 x 51 mm



Dilators (Myocardial)

Myocardial Dilator

CODE	DESCRIPTION	TIP WIDTH	LENGTH
25-8009	Graduated to 17.5 mm	2.0 mm	5 3/4 in 146 mm



25-8019

Dilators (Vascular)

Garrett Dilator

Malleable Shaft

CODE	DESCRIPTION	LENGTH
25-8015	Complete Set of All Sizes	
25-8016	1.0 mm	8 1/4 in 210 mm
25-8017	1.5 mm	8 1/4 in 210 mm
25-8018	2.0 mm	8 1/4 in 210 mm
25-8019	2.5 mm	8 1/4 in 210 mm
25-8020	3.0 mm	8 1/4 in 210 mm
25-8021	3.5 mm	8 1/4 in 210 mm
25-8022	4.0 mm	8 1/4 in 210 mm
25-8023	4.5 mm	8 1/4 in 210 mm
25-8024	5.0 mm	8 1/4 in 210 mm



Questions? Contact us at customerservice@symmetrysurgical.com
or learn more at symmetrysurgical.com

Dilators (Vascular)

Garrett Dilator Set

CODE	DESCRIPTION
55-7060	Dilator Set



DeBakey Vascular Dilator

Malleable Shaft

CODE	TIP SIZE	LENGTH
55-7200	Complete Set of All Sizes (includes the following)	
55-7205	0.5 mm	7½ in 191 mm
55-7015	2.0 mm	8¼ in 210 mm
55-7225	2.5 mm	7½ in 191 mm
55-7230	3.0 mm	7½ in 191 mm
55-7235	3.5 mm	7½ in 191 mm
55-7240	4.0 mm	7½ in 191 mm
55-7019	4.0 mm	8¼ in 210 mm
55-7245	4.5 mm	7½ in 191 mm
55-7020	4.5 mm	8¼ in 210 mm
55-7250	5.0 mm	7½ in 191 mm
55-7270	7.0 mm	7½ in 191 mm
55-7290	9.0 mm	7½ in 191 mm

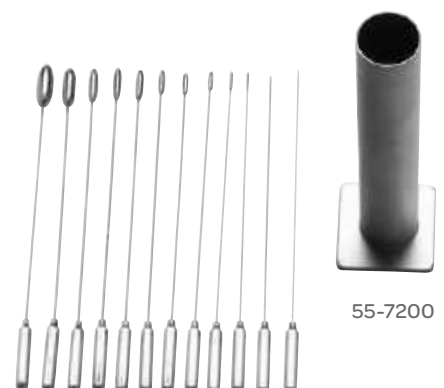

Dilators (Vascular)



Garrett Vascular Dilator

Malleable Shaft

25-8035

CODE	TIP SIZE	LENGTH
25-8035	Set of nine in 21-8005 case	
25-8036	1.0 mm	5½ in 140 mm
25-8037	1.0 mm	5½ in 140 mm
25-8038	2.0 mm	5½ in 140 mm
25-8039	2.0 mm	5½ in 140 mm
25-8040	3.0 mm	5½ in 140 mm
25-8041	3.5 mm	5½ in 140 mm
25-8042	4.0 mm	5½ in 140 mm
25-8043	4.5 mm	5½ in 140 mm
25-8044	5.0 mm	5½ in 140 mm

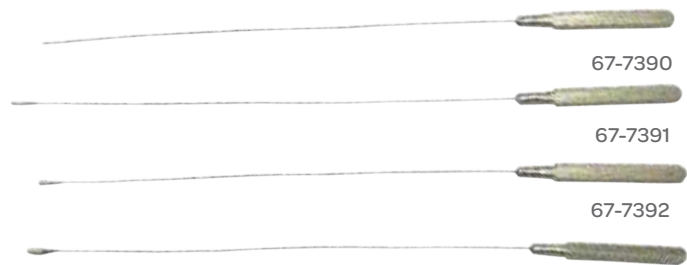

67-7390

67-7391

67-7392

67-7393

Vascular Dilator

Malleable Shaft

CODE	TIP SIZE	LENGTH
67-7390	1.0 mm	9½ in 241 mm
67-7391	1.5 mm	9½ in 241 mm
67-7392	2.0 mm	9½ in 241 mm
67-7393	2.5 mm	9½ in 241 mm
67-7394	3.0 mm	9½ in 241 mm
67-7395	3.5 mm	9½ in 241 mm
67-7396	4.0 mm	9½ in 241 mm
67-7397	4.5 mm	9½ in 241 mm
67-7398	5.0 mm	9½ in 241 mm

Dilators (Vascular)



Garrett Vascular Dilator

Malleable Shaft

55-7002

CODE	TIP SIZE	LENGTH
55-7002	Set of nine sizes with holder	
55-7003	1.0 mm	5½ in 140 mm
55-7004	1.5 mm	5½ in 140 mm
55-7005	2.0 mm	5½ in 140 mm
55-7006	2.5 mm	5½ in 140 mm
55-7007	3.0 mm	5½ in 140 mm
55-7008	3.5 mm	5½ in 140 mm
55-7009	4.0 mm	5½ in 140 mm
55-7010	4.5 mm	5½ in 140 mm
55-7011	5.0 mm	5½ in 140 mm

Dilators (Vascular Dilator)



Garrett Vascular Dilator

Malleable Shaft

55-7012

CODE	TIP SIZE	LENGTH
55-7012	Set of nine sizes with holder	
55-7013	1.0 mm	8¼ in 210 mm
55-7014	1.5 mm	8¼ in 210 mm
55-7015	2.0 mm	8¼ in 210 mm
55-7016	2.5 mm	8¼ in 210 mm
55-7017	3.0 mm	8¼ in 210 mm
55-7018	3.5 mm	8¼ in 210 mm
55-7019	4.0 mm	8¼ in 210 mm
55-7020	4.5 mm	8¼ in 210 mm
55-7020	5.0 mm	8¼ in 210 mm

Dilators (Vascular Dilator)

DeBakey Vascular Dilator

CODE	TIP SIZE	LENGTH
55-7210	1.0 mm	7½ in 191 mm
55-7215	1.5 mm	7½ in 191 mm
55-7220	2.0 mm	7½ in 191 mm

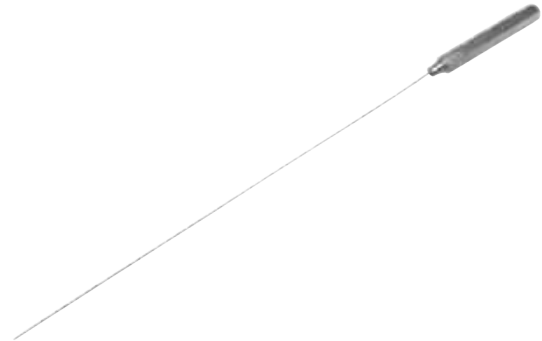

Cooley Coronary Dilator

Aluminum, Malleable Shaft, 5 in (127 mm)

CODE	DESCRIPTION
55-7001	Complete Set of Six Sizes
55-7105	0.5 mm Shaft
55-7110	1.0 mm Shaft
55-7115	1.5 mm Shaft
55-7120	2.0 mm Shaft
55-7125	2.5 mm Shaft
55-7130	3.0 mm Shaft



55-7125

Dissectors



63-8011

Lemmon Intima Dissector

CODE	DESCRIPTION	LENGTH
55-7042	Full Curve	6⅜ in 162 mm
55-7041	Medium Curve	6⅜ in 162 mm
63-8011	Slight Curve, Tip Width 4.0 mm	6½ in 165 mm
65-2405	Slightly Curved Dissector, Light Length	8¼ in 210 mm

Questions? Contact us at customerservice@symmetrysurgical.com
or learn more at symmetrysurgical.com

Dissectors

MagnaFree® Penfield Dissector

Titanium



CODE	DESCRIPTION	LENGTH	65-2405
65-2402	Broad Curved Dissector and Sharp Round Spoon, Double-Ended	7 in	178 mm
65-2403	Slightly Curved Dissector and Wax Packer, Double-Ended	7¾ in	197 mm
65-2404	Fully Curved Dissector and Wax Packer, Double-Ended	7¾ in	197 mm
65-2405	Slightly Curved Dissector, Light Length	8¼ in	210 mm

Milligan Dissector

Double-Ended

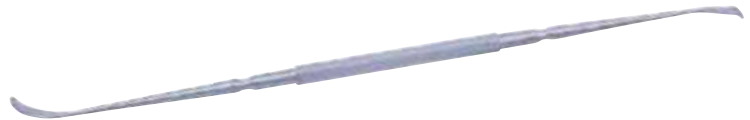

CODE	TIP SIZE	LENGTH
65-1038	14 mm and 16 mm	8½ in 216 mm

Penfield Dissector



65-1015

CODE	DESCRIPTION	LENGTH
65-1015	Broad Curved Dissector and Sharp Round Spoon, Double-Ended	7 in 178 mm
65-1016	Slightly Curved Dissector and Wax Packer, Double-Ended	7¾ in 197 mm
65-1017	Full Curved Dissector and Wax Packer, Double-Ended	7¾ in 197 mm
65-1018	Slightly Curved Dissector, Light	8¼ in 210 mm
65-1019	Slightly Curved Blunt Dissector, Double-Ended	11½ in 272 mm

Dissectors

Smithwick Neck Hook-Dissector

Double-Ended-Blunt



CODE	HOOK LENGTH	TIP DIAMETER	LENGTH
38-1088	7/16 in 11 mm	0.2 mm	12 in 305 mm

Elevators

Cushing Elevator

Slightly Curved, Rounded Edge, Sharp

CODE	DESCRIPTION	LENGTH
26-6201	15 mm Wide	7 1/8 in 181 mm

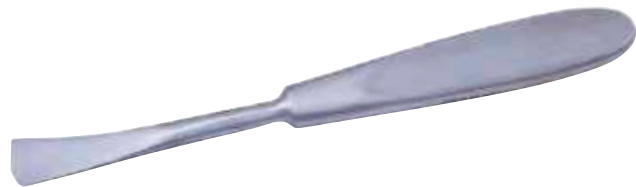

Elevators (Periosteal)

Freer Periosteal Elevator

One End Sharp and One End Blunt, Double-Ended

CODE	TIP	LENGTH
55-7026	6.5 mm	7 1/2 in 181 mm
55-7027	4.5 mm	7 1/2 in 181 mm



55-7026

Questions? Contact us at customerservice@symmetrysurgical.com
or learn more at symmetrysurgical.com

Forceps (Alligator)

Hoen Alligator Forceps

1x2

CODE	TIP WIDTH	LENGTH
30-1230	2.2 mm	5½ in 140 mm

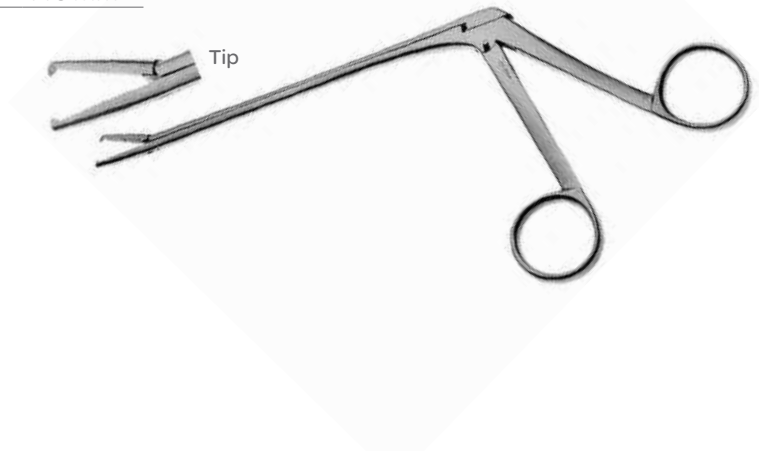

Forceps (Artery)

Artery Forceps

CODE	DESCRIPTION	LENGTH
32-3548	Serrated, Curved	14 in 356 mm



Heiss Artery Forceps

CODE	DESCRIPTION	LENGTH
30-8016	Curved	7¼ in 184 mm

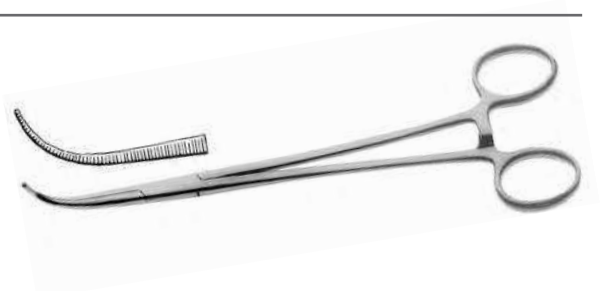

Forceps (Artery)

Nissen Artery Forceps

CODE	DESCRIPTION	LENGTH
16-4025	Curved	7¼ in 184 mm



Sarot Artery Forceps

Slightly Curved

CODE	JAW LENGTH	LENGTH
30-8059	2¼ in 57 mm	9 in 229 mm



Adson Artery Forceps

CODE	JAW LENGTH	LENGTH
16-4019	Straight, Standard Pattern	7⅞ in 181 mm
16-4021	Straight, Standard Pattern	8¼ in 210 mm
16-4118	Curved, Delicate Pattern	7⅞ in 181 mm
16-4119	Curved, Standard Pattern	7¼ in 184 mm
16-4121	Curved, Standard Pattern	8¼ in 210 mm



16-4019

Questions? Contact us at customerservice@symmetrysurgical.com
or learn more at symmetrysurgical.com

Forceps (Artery)

Carmalt Artery Forceps

Jaws with Longitudinal Serrations and Cross-Serrated Tips

CODE	DESCRIPTION	LENGTH
16-3616	Straight	6 ½ in 165 mm
16-3716	Curved	8 7/8 in 225 mm
16-3720	Curved	9 in 229 mm
16-3723	Curved	6 ½ in 165 mm



16-3616

Coller-Crile Artery Forceps

CODE	DESCRIPTION	LENGTH
15-7384	Curved	5 ½ in 140 mm



Crafoord Coller Artery Forceps

CODE	DESCRIPTION	LENGTH
16-1524	Curved, Delicate Pattern	9 in 229 mm



Forceps (Artery)

Crile Artery Forceps

CODE	DESCRIPTION	LENGTH
15-7316	Curved	6¼ in 159 mm



Harrington Artery Forceps

CODE	DESCRIPTION	LENGTH
16-3727	Curved	10¾ in 273 mm

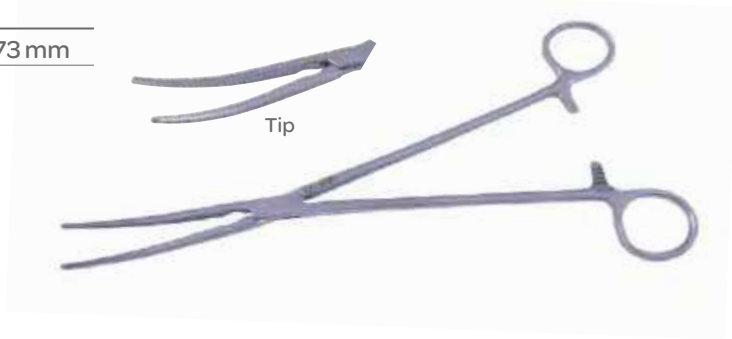

Heiss Artery Forceps

Delicate Pattern

CODE	DESCRIPTION	LENGTH
16-5024	Straight	9½ in 241 mm
16-5124	Curved	9¼ in 235 mm
16-5190	90°, Right Angle	8 in 203 mm
16-5194	90°, Right Angle	9½ in 241 mm



16-5190

Phaneuf Artery Forceps

CODE	DESCRIPTION	LENGTH
16-8021	Straight, 1 x 2 Teeth	8½ in 216 mm



Questions? Contact us at customerservice@symmetrysurgical.com
or learn more at symmetrysurgical.com

Forceps (Artery)

Rochester-Mixer Artery Forceps

CODE	JAWS	LENGTH
17-0736	Angled 80°	6 ¼ in 159 mm
17-0740	Angled 80°	8 in 203 mm



17-0736

Sarot Artery Forceps

CODE	DESCRIPTION	LENGTH
54-5002	Horizontal Serrations	9 ½ in 241 mm
54-4900	Horizontal Serrations	11 in 279 mm
54-4905	Horizontal Serrations	13 in 330 mm



54-5002

Wikstroem Artery Forceps

CODE	DESCRIPTION	LENGTH
17-0770	Right Angled	8 ¼ in 210 mm



Forceps (Bariatric)

Bariatric Forceps

CODE	DESCRIPTION	LENGTH
32-3551	Right Angled	12 ¼ in 311 mm
32-3552	Right Angled	14 in 355 mm



32-3551

Rochester-Ochsner Bariatric Forceps

1 x 2 Teeth, Serrated

CODE	DESCRIPTION	LENGTH
32-3539	Straight	14 in 356 mm



Forceps (Clip Applier)

Spring Clip Applier

CODE	DESCRIPTION	LENGTH
37-4016	Used with Edward Parallel Jaw Spring Clips (Sold Separately)	7 ¼ in 184 mm

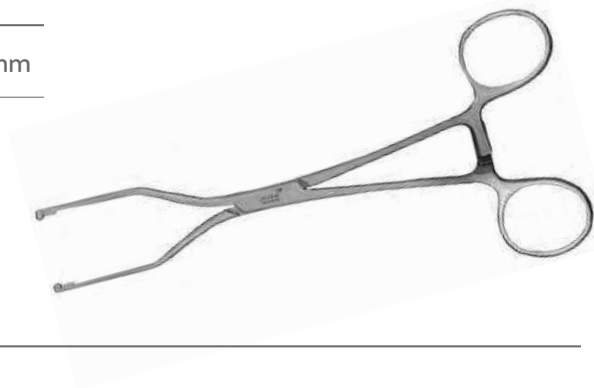

Forceps (Coarctation)

Crafoord Coarctation Forceps

CODE	DESCRIPTION	LENGTH
54-4709	Curved Jaw	9 ½ in 241 mm



Questions? Contact us at customerservice@symmetrysurgical.com
or learn more at symmetrysurgical.com

Forceps (Cooley Caval Occlusion)

Cooley Caval Occlusion Forceps

CODE	DESCRIPTION	LENGTH
55-7034	36 French	8 ¼ in 210 mm
55-7035	40 French	8 ¼ in 210 mm



55-7035

Forceps (Coronary)

Reul Coronary Forceps

Fine Serrations, Tungsten Carbide Inserts

CODE	TIP WIDTH	LENGTH
30-8014	1.8 mm	7 ¾ in 197 mm



Forceps (Deep Surgical)

Bridge Deep Surgical Forceps

CODE	DESCRIPTION	LENGTH
30-4700	Curved	11 in 279 mm

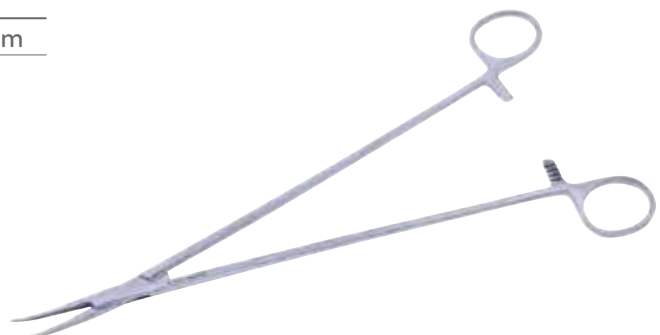

Forceps (Dissecting)

Meeker Deep Surgery Forceps

CODE	DESCRIPTION	LENGTH
30-4701	Right Angle	10 ³ / ₄ in 273 mm

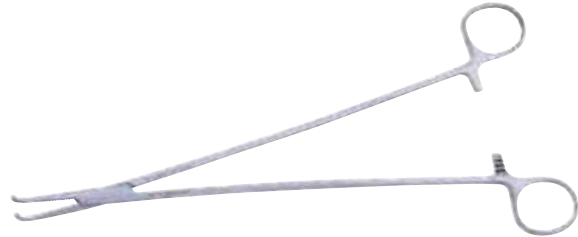

Thoracoscopy Meeker Dissecting Forceps

CODE	ANGLE	DIAMETER	LENGTH
54-0008	90° Curved	10 mm	8 ¹ / ₄ in 210 mm



Forceps (Dissecting Artery)

Rumel Dissecting Artery Forceps

CODE	DESCRIPTION	LENGTH
16-6761	Curved	9 in 229 mm



Forceps (Dressing)

Adson Bayonet Dressing Forceps

CODE	WORKING DISTANCE	LENGTH
30-1191	3 ⁵ / ₈ in 92 mm	7 ¹ / ₂ in 191 mm



Forceps (Dressing)

Adson Delicate Dressing Forceps

CODE	DESCRIPTION	TIP WIDTH	LENGTH
30-4214	Delicate	0.8 mm	5 in 127 mm



Adson Dressing Forceps

CODE	DESCRIPTION	TIP WIDTH	LENGTH
30-1185	Standard	1.2 mm	5 in 127 mm
30-1190	Standard	2.0 mm	7 in 178 mm



30-1190

Children's Hospital Classic® Delicate Dressing Forceps

CODE	DESCRIPTION	LENGTH
30-4208	Narrow Serrated Tips, Dissecting End	5 3/4 in 146 mm



Classic Plus® Dressing Forceps

Tungsten Carbide Tip

CODE	TIP WIDTH	LENGTH
36-6010	1.8 mm	6 in 152 mm



Forceps (Dressing)

Cushing Bayonet Dressing Forceps

Serrated, Bayonet Shape, Dissecting End

CODE	TIP WIDTH	LENGTH
30-1156	1.4 mm	7 ³ / ₄ in 197 mm
30-1155	1.8 mm	7 ¹ / ₄ in 184 mm



30-1155

Cushing Dressing Forceps

CODE	DESCRIPTION	TIP WIDTH	LENGTH
30-1152	Extra-Fine, Serrated Handle, Fine Tip	1.3 mm	7 in 178 mm
30-1150	Serrated Handle	1.5 mm	7 in 178 mm
30-1151	Gutsch Handle	1.7 mm	7 in 178 mm
30-1154	8, Serrated	1.8 mm	7 ³ / ₄ in 197 mm



30-1154

Dressing Forceps

Serrated

CODE	TIP WIDTH	LENGTH
30-4133	2.2 mm	5 in 127 mm
30-4134	2.2 mm	5 ¹ / ₂ in 140 mm
30-4135	2.3 mm	6 in 152 mm
30-4137	3.0 mm	8 in 203 mm
30-4138	3.0 mm	10 in 254 mm
30-4139	3.4 mm	12 in 305 mm



30-4138

Ewald-Hudson Dressing Forceps

CODE	TIP WIDTH	LENGTH
30-4215	1.7 mm	5 in 127 mm

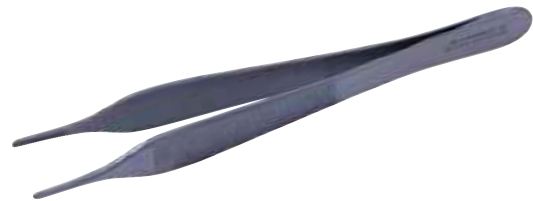

Forceps (Dressing)

Gerald Bayonet Dressing Forceps

Serrated, Bayonet Shape

CODE	WORKING DISTANCE	LENGTH
30-1216	3½ in 89 mm	7½ in 191 mm



Gerald Dressing Forceps

CODE	DESCRIPTION	TIP WIDTH	LENGTH
30-1214	Serrated, Straight	1.1 mm	7 in 178 mm



Hardy™ Dressing Forceps

Bayonet

CODE	WORKING DISTANCE	LENGTH
30-1205	4½ in 114 mm	8¼ in 210 mm



Hoehn Bayonet Dressing Forceps

Serrated, Bayonet Shape, Gutsch Handle

CODE	WORKING DISTANCE	LENGTH
30-1165	3 in 76 mm	7¾ in 197 mm



Forceps (Dressing)

Jansen Bayonet Dressing Forceps

Serrated, Bayonet Shape

CODE	WORKING DISTANCE	TIP WIDTH	LENGTH
30-6995	3 $\frac{1}{8}$ in 79 mm	2.0 mm	6 $\frac{1}{2}$ in 165 mm
30-1160	4 $\frac{3}{8}$ in 111 mm	1.8 mm	8 $\frac{1}{2}$ in 216 mm

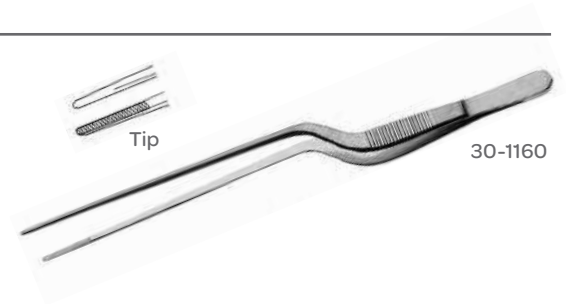

MagnaFree® Dressing Forceps

CODE	DESCRIPTION	LENGTH
65-2407	Serrated, Non-Magnetic (Titanium) for Interventional MRI	10 in 254 mm



Potts-Smith Dressing Forceps

CODE	DESCRIPTION	TIP WIDTH	LENGTH
30-8020	Serrated	1.4 mm	7 $\frac{1}{4}$ in 184 mm
30-8022	Serrated	1.5 mm	9 $\frac{3}{4}$ in 248 mm
30-8122	Serrated	1.6 mm	12 in 305 mm

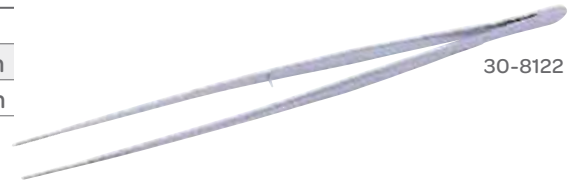

Rhoton® Dressing Forceps

CODE	DESCRIPTION	TIP WIDTH	LENGTH
80-1732	Titanium, Serrated Tips	1.8 mm	7 in 178 mm

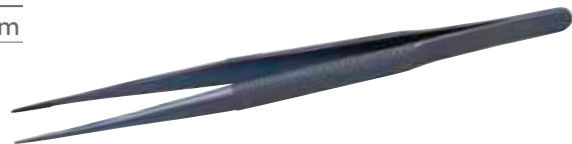

Semkin Dressing Forceps

CODE	DESCRIPTION	TIP WIDTH	LENGTH
30-1180	Serrated	1.3 mm	5 in 127 mm



Questions? Contact us at customerservice@symmetrysurgical.com
or learn more at symmetrysurgical.com

Forceps (Straight)

Forceps

Extra Fine Utility Forceps, Titanium

CODE	DESCRIPTION	TIP WIDTH	LENGTH
80-6631	Straight	0.3 mm	6 in 152 mm



80-6631

Forceps

Straight, Titanium, Closing Pressure (Appx) 50 gms

CODE	DESCRIPTION	TIP WIDTH	LENGTH
80-6001	Ring Tip	1.0 mm	6 in 152 mm
80-6002	Ring Tip, Serrated	1.0 mm	6 in 152 mm



80-6002

Forceps (Gallbladder)

Mixer Gallbladder Forceps

CODE	DESCRIPTION	LENGTH
30-4080	Curved	6¼ in 159 mm
30-4081	Curved	7¼ in 184 mm



30-4080

Forceps (Grasping)

Thoracoscopy DeBakey Grasping Forceps

CODE	DESCRIPTION	DIAMETER	LENGTH
54-0006	Straight	10 mm	8¼ in 210 mm

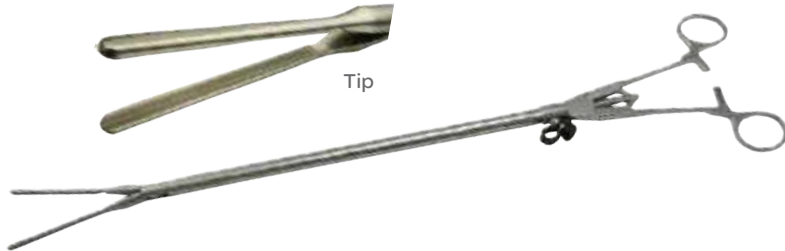

Thoracoscopy Masher Grasping Forceps

CODE	DESCRIPTION	DIAMETER	LENGTH
54-0003	Straight	10 mm	8¼ in 210 mm
54-0004	Curved	10 mm	8¼ in 210 mm
54-0005	Round	10 mm	8¼ in 210 mm



Thoracoscopy Pennington Grasping Forceps

CODE	DIAMETER	LENGTH
54-0002	10 mm	5½ in 130 mm



Forceps (Hemostatic)

Adson Hemostatic Forceps

CODE	DESCRIPTION	LENGTH
16-4218	Straight, Delicate Pattern, 1x2 Teeth	7⅞ in 181 mm
16-4318	Curved, Delicate Pattern, 1x2 Teeth	7⅞ in 181 mm



16-4218

Questions? Contact us at customerservice@symmetrysurgical.com
or learn more at symmetrysurgical.com

Forceps (Hemostatic)

Crile Classic® Delicate Hemostatic Forceps

CODE	DESCRIPTION	LENGTH
30-4467	Straight	5½ in 140 mm
30-4468	Curved	5½ in 140 mm



30-4467

Crile Classic® Hemostatic Forceps

CODE	DESCRIPTION	LENGTH
32-4030	Straight, Standard Line	5½ in 140 mm
32-4040	Straight, Standard Line	6¼ in 159 mm



32-4030

Crile Classic® Hemostatic Forceps

CODE	DESCRIPTION	LENGTH
33-4030	Straight, Bright Finish	5½ in 140 mm
33-4040	Straight, Bright Finish	6¼ in 159 mm
34-4030	Straight, Low-Glare Finish	5½ in 140 mm
34-4040	Straight, Low-Glare Finish	6¼ in 159 mm



34-4030

Crile Hemostatic Forceps

CODE	DESCRIPTION	LENGTH
32-4031	Curved, Standard Line	5½ in 140 mm
32-4041	Curved, Standard Line	6¼ in 159 mm

Forceps (Hemostatic)

Crile Classic® Hemostatic Forceps

CODE	DESCRIPTION	LENGTH
33-4031	Curved, Bright Finish	5½ in 140 mm
33-4041	Curved, Bright Finish	6¼ in 159 mm
34-4031	Curved, Low Glare Finish	5½ in 140 mm
34-4041	Curved, Low Glare Finish	6¼ in 159 mm



33-4031

Halsted Classic® Mosquito Forceps

CODE	DESCRIPTION	LENGTH
33-3900	Straight, Bright Finish	3½ in 89 mm
33-3901	Curved, Bright Finish	3½ in 89 mm
34-3900	Straight, Low-Glare Finish	3½ in 89 mm
34-4000	Straight, Low-Glare Finish	5 in 127 mm
34-3901	Curved, Low-Glare Finish	3½ in 89 mm
34-4001	Curved, Low-Glare Finish	5 in 127 mm



33-3900

Halsted Mosquito Forceps

CODE	DESCRIPTION	LENGTH
32-3900	Straight, Standard Line	3½ in 89 mm
32-3901	Curved, Standard Line	3½ in 89 mm



32-3900

Halsted Mosquito Forceps

CODE	DESCRIPTION	LENGTH
32-4000	Straight, Standard Line	5 in 127 mm
32-4001	Curved, Standard Line	5 in 127 mm

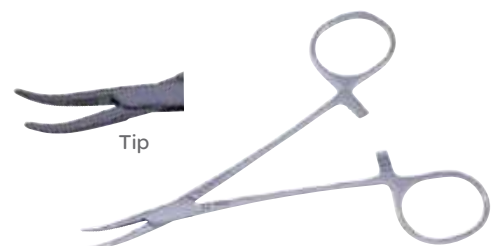

32-4001

Forceps (Hemostatic)

Halsted Classic® Mosquito Forceps

CODE	DESCRIPTION	LENGTH
33-4000	Straight, Bright Finish	5 in 127 mm
33-4001	Curved, Bright Finish	5 in 127 mm



33-4000

Halsted Hemostatic Forceps

CODE	DESCRIPTION	LENGTH
30-4039	Curved	7 in 178 mm



Hoehn Scalp Hemostat

CODE	DESCRIPTION	LENGTH
30-1115	Serrated, Curved on Side	5 3/8 in 137 mm



Kelly Classic® Hemostatic Forceps

CODE	DESCRIPTION	LENGTH
32-4020	Straight, Standard Line	5 1/2 in 140 mm
32-4021	Curved, Standard Line	5 1/2 in 140 mm



32-4020

Kelly Classic® Hemostatic Forceps

CODE	DESCRIPTION	LENGTH
33-4020	Straight, Bright Finish	5 1/2 in 140 mm
33-4021	Curved, Bright Finish	5 1/2 in 140 mm
34-4020	Straight, Low-Glare	5 1/2 in 140 mm
34-4021	Curved, Low-Glare	5 1/2 in 140 mm



33-4020

Forceps (Hemostatic)

Kocher Hemostatic Forceps

CODE	DESCRIPTION	LENGTH
32-4100	Straight, Bright Finish, 1x2 Teeth	5½ in 140 mm



Mixter-Pediatric Hemostatic Forceps

CODE	DESCRIPTION	LENGTH
17-0614	Very Delicate	5¾ in 137 mm
17-0619	Very Delicate	7½ in 191 mm



17-0614

Providence Hospital Hemostatic Forceps

CODE	DESCRIPTION	LENGTH
32-4011	Curved, Bright Finish	5½ in 140 mm



Forceps (Hemostatic)

Rankin Hemostatic Forceps

CODE	DESCRIPTION	LENGTH
32-4050	Straight, Bright Finish	6¼ in 159 mm
32-4051	Curved, Bright Finish	6¼ in 159 mm



32-4050

Rochester-Pean Forceps Hemostatic

CODE	DESCRIPTION	LENGTH
32-3553	Curved	12 in 305 mm
32-3554	Curved	14 in 356 mm



32-3553

Rochester-Ochsner Hemostatic Forceps

CODE	DESCRIPTION	LENGTH
30-4066	Straight	9 in 229 mm



Forceps (I.M.A.)

Jones I.M.A. Forceps

Titanium

CODE	DESCRIPTION	TOOTH SIZE		LENGTH	
80-1851	Straight	0.003 in	0.07 mm	7 in	178 mm
80-1853	Straight	0.004 in	0.01 mm	7 in	178 mm
80-1858	Straight	0.003 in	0.07 mm	8½ in	216 mm
80-1859	Straight	0.004 in	0.01 mm	8½ in	216 mm
80-1852	Bayonet	0.004 in	0.01 mm	8½ in	216 mm
80-1857	Bayonet	0.003 in	0.07 mm	8½ in	216 mm



80-1852

Forceps (Intestinal Forceps)

Single Intestinal Forceps

CODE	DESCRIPTION	LENGTH	
30-4517	Intestinal Forceps, Serrated Fenestrated Jaws	9 in	229 mm

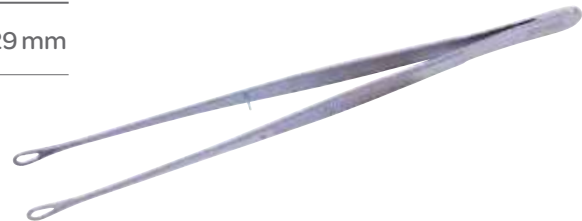

Forceps (Ligature Carrying)

Semb Ligature Carrying Forceps

CODE	DESCRIPTION	LENGTH	
30-8056	Acute Curve	9½ in	241 mm



Forceps (Lung)

Duval Lung Forceps

CODE	JAW WIDTH	LENGTH
30-8095	1 in 25 mm	7 ³ / ₄ in 197 mm



Lovelace Lung Grasping Forceps

CODE	ANGLE	JAW WIDTH	LENGTH
54-5019	One Side	1 in 25 mm	8 in 203 mm



Forceps (Micro)

DeBakey Micro Forceps

Tungsten Carbide Dusted Tip

CODE	DESCRIPTION	JAW WIDTH	LENGTH
55-9019	Counter Balanced Handle	1.0 mm	7 in 178 mm

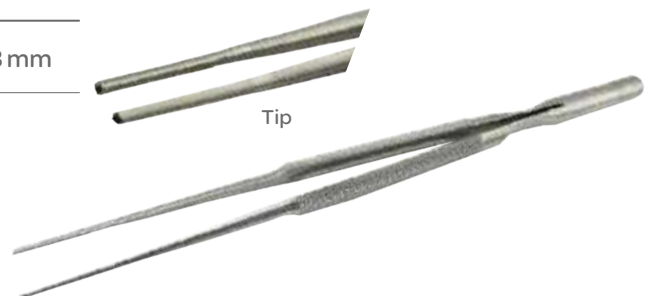

Dennis Micro Forceps

DeBakey Teeth, Counter Balanced Handle

CODE	DESCRIPTION	LENGTH
55-9088	Straight, 1.0 mm Tip	8 in 203 mm



Forceps (Micro)

Titanium Micro Forceps

CODE	DESCRIPTION	LENGTH
55-9086T	Straight, Round Handle	10 in 254 mm



Titanium Micro Ring Forceps

Fine Tungsten Carbide Dust Tips, with Platform, Lightweight Round Handle

CODE	TIP WIDTH	LENGTH
55-9066T	1.0 mm Ring Tip	6 in 152 mm
55-9055T	1.0 mm Ring Tip	7 in 178 mm
55-9056T	1.0 mm Ring Tip	8 ¼ in 210 mm

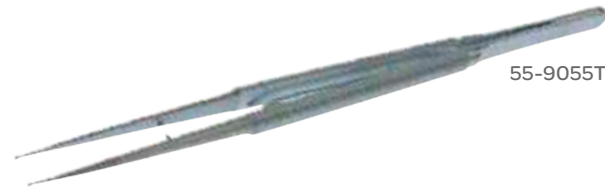

55-9055T

Titanium Micro Tissue Forceps

Fine Tungsten Carbide Dust Tips, Straight, without Platform

CODE	TIP WIDTH	LENGTH
55-9060T	1.0 mm	7 ½ in 191 mm
55-9062T	1.0 mm	9 in 229 mm



55-9060T

Titanium Ultra™ Micro Ring Tip Forceps

Fine Tungsten Carbide Dust Tips, Counter Balanced Handle

CODE	TIP WIDTH	LENGTH
55-9067T	1.0 mm	7 ¼ in 184 mm
55-9068T	1.0 mm	8 ¼ in 210 mm

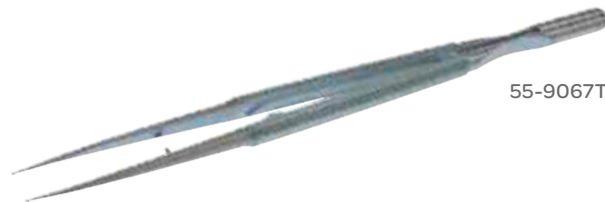

55-9067T

Ultra™ Micro Ring Tip Forceps

Fine Tungsten Carbide Dust Tips, Counter Balanced Handle

CODE	DESCRIPTION	TIP WIDTH	LENGTH
55-9067	Straight	1.0 mm	6 in 152 mm
55-9068	Straight	1.0 mm	7 ¼ in 184 mm
55-9069	Straight	1.0 mm	8 ¼ in 210 mm
55-9071	Straight	1.0 mm	9 in 229 mm

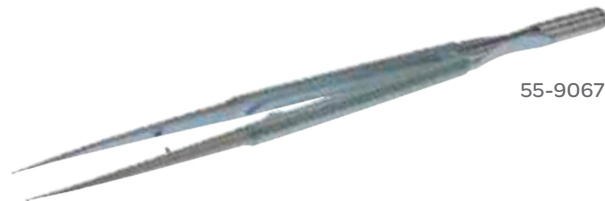

55-9067

Questions? Contact us at customerservice@symmetrysurgical.com
or learn more at symmetrysurgical.com

Forceps (Micro)

Jacobson Micro Artery Forceps

CODE	DESCRIPTION	LENGTH	
16-4088	Straight	7 in	178 mm
16-4189	Full Curve	7 in	178 mm
16-4188	Slight Curve	7 in	178 mm



16-4189

Forceps

Gemini Mixer Forceps

CODE	DESCRIPTION	LENGTH	
54-7262	Curved	14 in	356 mm



Forceps (Hemostatic)

Hemostatic Mosquito Classic®

CODE	DESCRIPTION	LENGTH	
30-4471	Straight, Delicate	4 in	102 mm
30-4473	Straight, Delicate	5 in	127 mm
30-4472	Curved, Delicate	4 in	102 mm
30-4474	Curved, Delicate	5 in	127 mm
30-4470	Curved, Delicate	6 in	152 mm



30-4470

Forceps (Multi-Purpose)

Castaneda Multi-Purpose Clamp

CODE	ANGLE	JAW LENGTH	LENGTH
30-9011	Straight	1 $\frac{3}{8}$ in 35mm	5 in 127mm



Forceps

DeBakey Opti-Length® Forceps

CODE	TIP WIDTH	LENGTH
67-7800	1.5 mm	12 in 305 mm
67-7802	1.5 mm	14 in 356 mm
67-7801	2.0 mm	12 in 305 mm
67-7803	2.0 mm	14 in 356 mm



57-7800

Satinsky Opti-Length® Forceps

General Surgery

CODE	TIP WIDTH	LENGTH
67-7584	2.0 mm	10 in 254 mm
67-7586	2.0 mm	12 in 305 mm
67-7585	3.0 mm	10 in 254 mm
67-7587	3.0 mm	12 in 305 mm



67-7584

Forceps (Plaque Forceps)

Plaque Remover

CODE	DESCRIPTION	LENGTH
55-9223	Gentle Curve, Mini	6 in 152 mm
55-9221	Right Angle, Long	7 $\frac{1}{4}$ in 184 mm



55-9223

Questions? Contact us at customerservice@symmetrysurgical.com
or learn more at symmetrysurgical.com

Forceps (Plaque Forceps)

Wheeler Plaque Forceps

CODE	DESCRIPTION	LENGTH
55-8910	Forceps	5½ in 140 mm
55-8915	Forceps	7¾ in 197 mm



Forceps (Right Angle)

Delicate Right Angle Forceps

CODE	DESCRIPTION	LENGTH
54-7275	Full Curved Jaws	5¼ in 133 mm
54-7277	Full Curved Jaws	7¼ in 184 mm

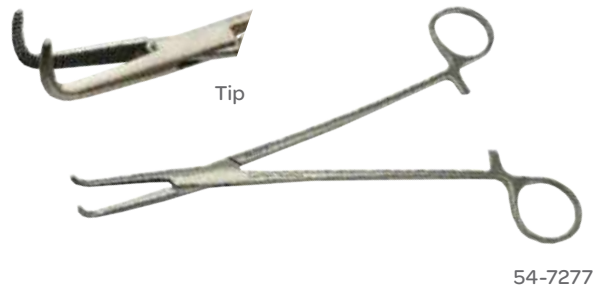

Gemini Right Angle Forceps

CODE	DESCRIPTION	LENGTH
54-7266	Right Angle Forceps	16 in 406 mm



Heiss Right Angle Forceps

CODE	DESCRIPTION	LENGTH
54-7249	Right Angle Forceps	8 in 203 mm



Forceps (Ring Tip Forceps)

Titanium Gerald Ring Tip Forceps

Fine Tungsten Carbide Dust Tips, Flat Handle

CODE	TIP WIDTH	LENGTH
55-9036T	1.0 mm	7 in 178 mm

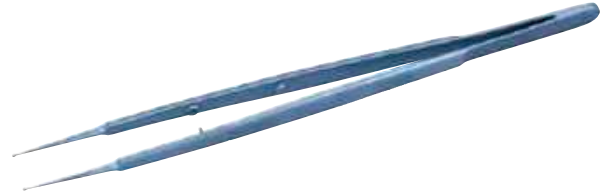

Ultra™ Micro Ring Tip Forceps

Fine Tungsten Carbide Dust Tips, Round Lightweight Handle, with Platform

CODE	DESCRIPTION	LENGTH
55-9041	1.0 mm Tips	7½ in 191 mm
55-9042	1.0 mm Tips	8¼ in 210 mm

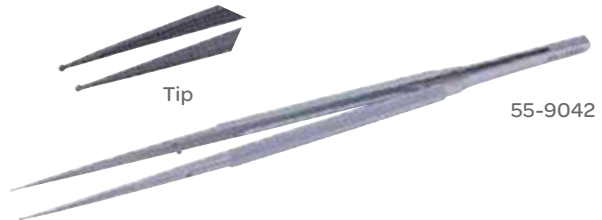

Ultra™ Micro Ring Tip Forceps

Fine Tungsten Carbide Dust Tips, Round Lightweight Handle, without Platform

CODE	DESCRIPTION	LENGTH
55-9055	1.0 mm Tips	7½ in 191 mm
55-9056	1.0 mm Tips	8¼ in 210 mm
55-9057	1.0 mm Tips	9 in 229 mm

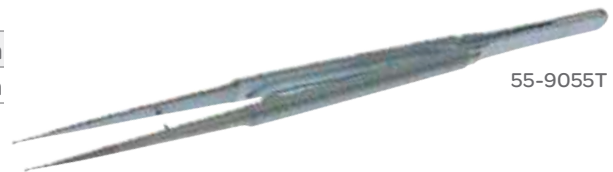

Forceps (Sponge)

Bariatric Sponge Forceps

CODE	DESCRIPTION	LENGTH
32-3540	Serrated Jaw, Straight	14 in 356 mm



Questions? Contact us at customerservice@symmetrysurgical.com
or learn more at symmetrysurgical.com

Forceps (Sponge)

Classic® Sponge Holding Forceps

Serrated Jaws, Bright Finish

CODE	DESCRIPTION	LENGTH
33-6030	Straight	9 in 229 mm
33-6031	Curved	9 in 229 mm



33-6030

Sponge Holding Forceps

Serrated Jaws, Bright Finish

CODE	DESCRIPTION	LENGTH
32-6010	Straight	7 in 178 mm
32-6030	Straight	9 in 229 mm
32-6011	Curved	7 in 178 mm
32-6031	Curved	9 in 229 mm
32-3542	1x2 Teeth	14 in 356 mm

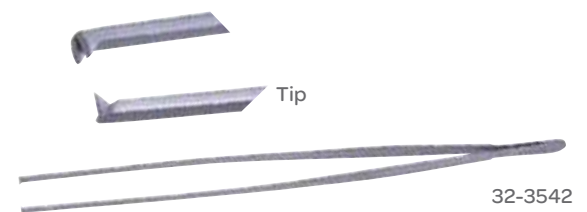

32-3542

Forceps (Stay Suture Clamp)

Gregory Stay Suture Clamp

CODE	DESCRIPTION	LENGTH
19-8026	#1, Gold Band	5/8 in 16 mm



Forceps (Suture Tag)

Castaneda Suture Tag Forceps

Smooth Jaws

CODE	DESCRIPTION	LENGTH
30-9007	#1	3 1/2 in 89 mm
30-9008	#2	3 1/2 in 89 mm
30-9009	#3	3 1/2 in 89 mm
30-9010	#4	3 1/2 in 89 mm



30-9007

Forceps (Thoracic)

Rochester-Pean Thoracic Forceps

CODE	DESCRIPTION	LENGTH
30-8093	Curved, Cross Serrations	12 in 305 mm



Rumel Thoracic Forceps

CODE	DESCRIPTION	LENGTH
30-8070	Slight Curve	9 in 229 mm
30-8072	Full Curve	9 in 229 mm
30-8073	Right Angle	9 in 229 mm



30-8070

Thoracic Forceps

CODE	DESCRIPTION	LENGTH
30-8082	Delicately Curved	9½ in 241 mm



Julian Thoracic Artery Forceps

Slightly Curved

CODE	JAW LENGTH	LENGTH
37-4034	24 mm	9¼ in 235 mm



Forceps (Thoracic Clamp)

Harrington Thoracic Clamp

Longitudinal Serrations with Cross-Serrated Tips

CODE	DESCRIPTION	LENGTH
30-8049	Right Angled	12 in 305 mm

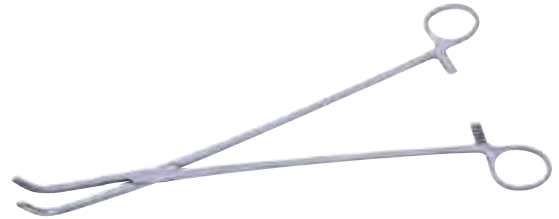

Forceps (Tissue)

Adson Hemostatic Forceps

CODE	DESCRIPTION	LENGTH
30-1010	Straight	7 1/4 in 184 mm
30-1011	Curved	7 1/4 in 184 mm

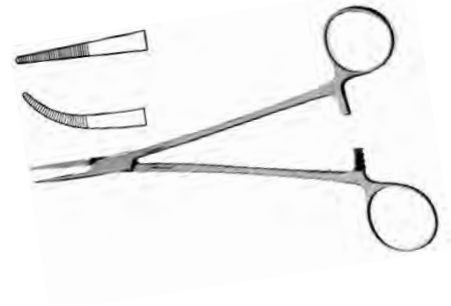

Adson Tissue Forceps

CODE	DESCRIPTION	TIP WIDTH	LENGTH
30-1186	1x2 Teeth	1.2 mm	5 in 127 mm
30-1187	2x3 Teeth	1.8 mm	5 in 127 mm
30-1188	2x3 Teeth	3.0 mm	7 in 178 mm



Adson Classic Plus® Tissue Forceps

CODE	DESCRIPTION	TIP WIDTH	LENGTH
36-6000	Tungsten Carbide Tip Inserts	2.0 mm	4 3/4 in 121 mm



Forceps (Tissue)

Adson-Brown Tissue Forceps

CODE	TIP WIDTH	LENGTH
30-1189	1.7 mm	5 in 127 mm



Allis Classic® Tissue Forceps

CODE	DESCRIPTION	TEETH	LENGTH
32-7000	Standard Line	4 x 5	6 in 152 mm
32-7001	Standard Line	5 x 6	6 in 152 mm
32-7010	Standard Line	5 x 6	7 ¼ in 184 mm



32-7001

Allis Classic® Tissue Forceps

CODE	DESCRIPTION	TEETH	LENGTH
33-7000	Bright Finish	4 x 5	6 in 152 mm
33-7001	Bright Finish	5 x 6	6 in 152 mm
33-7010	Bright Finish	5 x 6	7 ¼ in 184 mm
34-7000	Low-Glare Finish	4 x 5	6 in 152 mm
34-7001	Low-Glare Finish	5 x 6	6 in 152 mm
34-7010	Low-Glare Finish	5 x 6	7 ¼ in 184 mm



34-7001

Allis Classic® Delicate Tissue Forceps

CODE	DESCRIPTION	TEETH	LENGTH
30-4466	Tissue Forceps	5 x 6	5 in 127 mm



Allis-Adair Tissue Forceps

CODE	DESCRIPTION	LENGTH
30-4542	9 x 10 Teeth	6 in 152 mm



Forceps (Tissue)

Bonney Tissue Forceps

CODE	TEETH	TIP WIDTH	LENGTH
30-1129	1x2	3.0 mm	6 ³ / ₄ in 171 mm

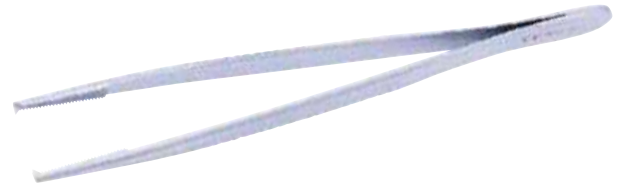

Brigham Tissue Forceps

Dissecting End

CODE	TEETH	TIP WIDTH	LENGTH
30-4239	1x2	2.2 mm	5 ¹ / ₂ in 140 mm



Brown Tissue Forceps

Parallel Multiple Teeth

CODE	TIP WIDTH	LENGTH
30-4200	2.2 mm	6 ¹ / ₄ in 159 mm
30-4201	3.1 mm	8 in 203 mm
30-4202	3.4 mm	10 in 254 mm



30-4201

Cushing Bayonet Tissue Forceps

Fine Tungsten Carbide Inserts, Bayonet Shape, Dissecting End

CODE	DESCRIPTION	TIP WIDTH	WORKING DISTANCE	LENGTH
30-1146	1x2 Teeth	1.6 mm	3 ³ / ₈ in	7 ¹ / ₄ in 184 mm
30-1147	1x2 Teeth	1.6 mm	3 in	7 ³ / ₄ in 197 mm



30-1146

Cushing Classic Plus® Bayonet Tissue Forceps

Bayonet Shape, Dissecting End, Fine Tungsten Carbide Inserts

CODE	DESCRIPTION	TIP WIDTH	WORKING DISTANCE	LENGTH
36-6007	7 ³ / ₄ in	1.4 mm	3 in 76 mm	7 ³ / ₄ in 197 mm



Forceps (Tissue)

Cushing Tissue Forceps

1 x 2 Teeth, Dissecting End

CODE	DESCRIPTION	TIP WIDTH	LENGTH
32-520	Straight		7 $\frac{1}{16}$ in 179 mm
30-1140	Serrated Handle	1.5 mm	7 in 178 mm
30-1142	Gutsch Handle	1.7 mm	7 in 178 mm
30-1143	Gutsch Handle, Fine Tip	1.3 mm	7 in 178 mm

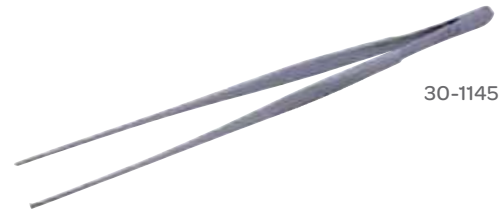

30-1145

Cushing Tissue Forceps

1 x 2 Teeth

CODE	DESCRIPTION	TIP WIDTH	LENGTH
30-1145		1.6 mm	7 $\frac{3}{4}$ in 197 mm



Classic Plus® Cushing Tissue Forceps

Tungsten Carbide Inserts

CODE	DESCRIPTION	TIP WIDTH	LENGTH
32-520	Straight		7 $\frac{1}{16}$ in 179 mm
36-6005	Straight	1.4 mm	7 in 178 mm



36-6005

DeBakey Classic® Vascular Forceps

Tips Taper from 1.5–1.3 mm for the Distal 20 mm

CODE	DESCRIPTION	LENGTH
37-1010	DeBakey Teeth	6 in 152 mm
37-1011	DeBakey Teeth	7 $\frac{3}{4}$ in 197 mm
37-1012	DeBakey Teeth	9 $\frac{1}{2}$ in 241 mm
37-1013	DeBakey Teeth	12 in 305 mm



37-1010

DeBakey-Collier Tissue Forceps

CODE	DESCRIPTION	LENGTH
32-3549	Angled, Serrated	14 in 356 mm

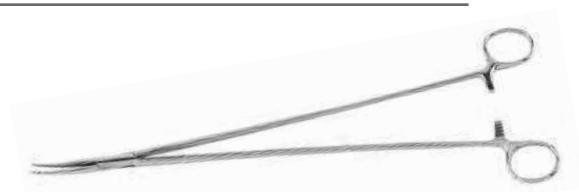

Questions? Contact us at customerservice@symmetrysurgical.com
or learn more at symmetrysurgical.com

Forceps (Tissue)

DeBakey Needle Pulling Tissue Forceps

CODE	DESCRIPTION	LENGTH
32-559	1.5 mm Tips with	7 ³ / ₈ in 187 mm



DeBakey Thoracic Tissue Forceps

CODE	DESCRIPTION	LENGTH
32-3550	Tissue Forceps	14 in 356 mm



DeBakey Tissue Forceps

Fine Tungsten Carbide Inserts

CODE	DESCRIPTION	LENGTH
32-564	1.5 mm Tips	6 in 152 mm
32-565	1.5 mm Tips	8 ¹ / ₄ in 210 mm
32-566	1.5 mm Tips	9 ⁵ / ₈ in 244 mm
32-561	2.0 mm Tips	7 ⁷ / ₈ in 200 mm
32-562	2.0 mm Tips	9 ¹ / ₂ in 241 mm
32-563	2.0 mm Tips	12 in 305 mm



32-561

DeBakey Tissue Forceps

Tips Taper 2.5–2.0 mm for the Distal 20 mm

CODE	DESCRIPTION	LENGTH
37-1000	DeBakey Teeth	6 in 152 mm
37-1001	DeBakey Teeth	7 ³ / ₄ in 197 mm
37-1002	DeBakey Teeth	9 ¹ / ₂ in 241 mm
37-1003	DeBakey Teeth	12 in 305 mm



37-1001

Forceps (Tissue)

Delicate Adson Tissue Forceps

CODE	TEETH	TIP WIDTH	LENGTH
30-4218	1x2	0.7 mm	5 in 127 mm



D'Errico Bayonet Tissue Forceps

Bayonet Shape

CODE	TEETH	TIP WIDTH	WORKING DISTANCE	LENGTH
30-1201	1x2	2.4 mm	3 3/8 in 86 mm	8 3/4 in 222 mm
30-1203	1x2	2.1 mm	3 1/4 in 83 mm	8 3/4 in 222 mm

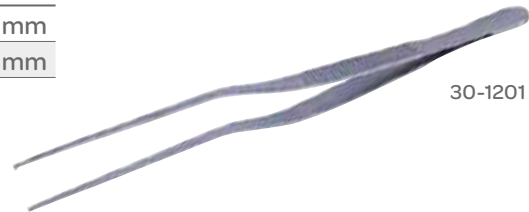

30-1201

Duval Tissue Forceps

Triangular Jaws, Tungsten Carbide Inserts

CODE	JAW WIDTH	LENGTH
36-6055	3/8 in 10 mm	8 1/4 in 210 mm

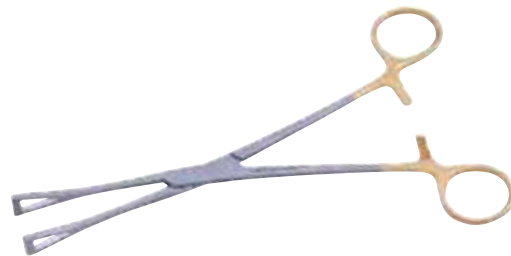

Ewald-Hudson Tissue Forceps

CODE	TEETH	TIP WIDTH	LENGTH
30-4216	1x2	1.6 mm	5 in 127 mm

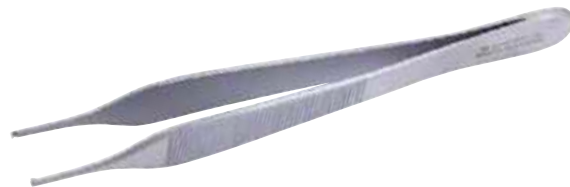

Ferris Smith Tissue Forceps

CODE	TEETH	TIP WIDTH	LENGTH
30-1132	2x3	3.9 mm	6 3/4 in 171 mm



Questions? Contact us at customerservice@symmetrysurgical.com
or learn more at symmetrysurgical.com

Forceps (Tissue)

Gemini Tissue Forceps

CODE	DESCRIPTION	LENGTH
32-3546	Serrated Tip	14 in 356 mm



Gerald Tissue Forceps

Bayonet Shape

CODE	TEETH	WORKING DISTANCE	TIP WIDTH	LENGTH
30-1213	1x2	3 1/2 in 89 mm	1.3 mm	7 1/2 in 191 mm



Gerald Tissue Forceps

CODE	DESCRIPTION	LENGTH
55-9092	DeBakey Teeth	9 1/2 in 241 mm



Gerald Tissue Forceps

CODE	TEETH	ANGLE	TIP WIDTH	LENGTH
30-1210	1x2	Straight	1.3 mm	7 in 178 mm



Gerald Tissue Forceps

CODE	DESCRIPTION	LENGTH
55-9002T	Titanium	8 in 203 mm

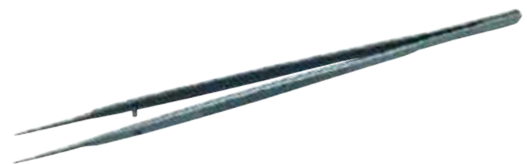

Forceps (Tissue)

Gerald Tissue Forceps

Tungsten Carbide Insert

CODE	TIP WIDTH	LENGTH
32-3531	1.0 mm	7 in 178 mm
32-3532	1.0 mm	10 in 254 mm



32-3531

Gerald Tissue Forceps

Titanium, with Platform

CODE	TIP WIDTH	LENGTH
55-9017T	1.0 mm	7 in 178 mm



Gerald Tissue Forceps

CODE	DESCRIPTION	LENGTH
55-9000	Serrated	7 in 178 mm
55-9004	Serrated	9½ in 241 mm
55-9005	Serrated	12 in 305 mm
55-9006	Serrated	14 in 356 mm



55-9000

Gerald Tissue Forceps

CODE	DESCRIPTION	LENGTH
55-9001	1x2 Teeth	7 in 178 mm
55-9012	1x2 Teeth	9¼ in 235 mm
55-9013	1x2 Teeth	14 in 356 mm



55-9001

Gerald Tissue Forceps

CODE	DESCRIPTION	LENGTH
55-9048	Cross Serrated Tips	7¾ in 197 mm
55-9044	Cross Serrated Tips	9⅝ in 244 mm



55-9048

Gerald Tissue Forceps

Fine Tungsten Carbide Dust Tips

CODE	DESCRIPTION	LENGTH
55-9043	1.0 mm Tip	8 in 203 mm
55-9049	1.0 mm Tip	7 in 178 mm
55-9017	1.0 mm Tip, with Platform	7 in 178 mm

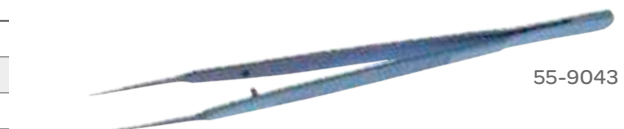

55-9043

Forceps (Tissue)

Titanium Gerald Tissue Forceps

CODE	DESCRIPTION	LENGTH	
55-9000T	Titanium, Serrated	7 in	178 mm



Gerald-DeDakey Ring Tip Forceps

CODE	TIP SIZE	LENGTH	
55-9036	1.0 mm	7 in	178 mm
55-9037	1.0 mm	8 in	203 mm



55-9036

Gerald-DeBakey Tissue Forceps

DeBakey Teeth

CODE	TIP SIZE	LENGTH	
55-9046	1.0 mm	7 in	178 mm
55-9039	1.0 mm	8 in	203 mm
55-9038	Angled	7 in	178 mm



55-9046

Titanium DeBakey-Gerald Tissue Forceps

Lightweight Round Handle

CODE	TIP SIZE	LENGTH	
55-9046T	1.0 mm	7 ¼ in	184 mm

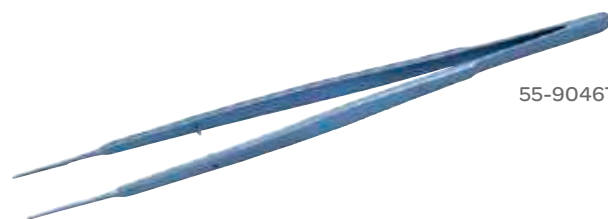

55-9046T

Gerald-DeBakey Tissue Forceps

With DeBakey Teeth, Light Weight Round Handle

CODE	TIP SIZE	LENGTH	
55-9045	1.0 mm	7 ¼ in	184 mm
55-9045T	1.0 mm, Titanium	7 ¼ in	184mm
55-9035	1.0 mm	8 ¼ in	210 mm
55-9035T	1.0 mm, Titanium	8 ¼ in	210 mm



55-9045

Forceps (Tissue)

Hoen Bayonet Tissue Forceps

1 x 2 Teeth, Bayonet Shape, Gutsch Handle, Working Distance: 3 in (76 mm)

CODE	TIP WIDTH	LENGTH
30-1166	2.1 mm	7 ³ / ₄ in 197 mm



Lockwood-Allis Tissue Forceps

5 x 6 Teeth

CODE	TIP WIDTH	LENGTH
30-4535	³ / ₁₆ in 5.0 mm	6 in 152 mm



MagnaFree® Adson Tissue Forceps

Non-Magnetic, Titanium

CODE	DESCRIPTION	LENGTH
65-2413	1 x 2 Teeth	5 in 127 mm



MagnaFree® Tissue Forceps

Non-Magnetic, Titanium

CODE	TIP WIDTH	LENGTH
65-2420	3.9 mm	5 ¹ / ₂ in 140 mm



Martin Tissue Forceps

CODE	TIP WIDTH	LENGTH
30-4230	6.0 mm	6 in 152 mm
30-4231	6.0 mm	7 in 178 mm



30-4231

Forceps (Tissue)

Mayo-Russian Tissue Forceps

Fenestrated Jaws

CODE	TIP WIDTH	LENGTH
30-8112	6.0 mm	9 in 229 mm

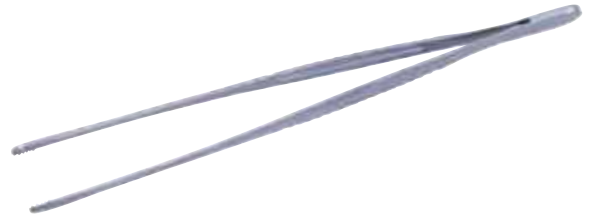

Micro Tissue Forceps, Straight

Fine Tungsten Carbine Dust Tips, 1.0 mm Tips

CODE	DESCRIPTION	LENGTH
55-9058	With Platform, Counter Balanced Handle	7 in 178 mm
55-9061	With Platform, Counter Balanced Handle	8 ¼ in 210 mm
55-9086	With Platform, Counter Balanced Handle	10 in 254 mm
55-9065	With Platform, Lightweight Pattern Round Handle	8 ⅝ in 213 mm
55-9082	With Platform, Lightweight Pattern Round Handle	9 in 229 mm
55-9060	Without Platform, Lightweight Pattern Round Handle	7 ⅞ in 181 mm
55-9062	Without Platform, Counter Balanced Handle	8 ½ in 216 mm



Micro Tissue Forceps, Curved

Fine Tungsten Carbine Dust Tips with Platform, 1.0 mm Tips

CODE	DESCRIPTION	LENGTH
55-9059	Counter Balanced Handle	7 in 178 mm
55-9083	Lightweight Pattern Round Handle	7 ⅞ in 181 mm



Potts-Smith Tissue Forceps

Fine Tungsten Carbide Inserts

CODE	DESCRIPTION	TIP WIDTH	LENGTH
36-6015	Tissue Forceps	1.5 mm	9 in 229 mm

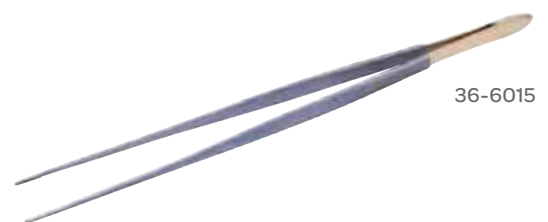

Forceps (Tissue)

Potts-Smith Tissue Forceps

CODE	DESCRIPTION	TIP WIDTH	LENGTH
30-8023	1x2 Teeth	1.7 mm	7¼ in 184 mm
30-8024	1x2 Teeth	1.7 mm	8¼ in 210 mm
30-8123	1x2 Teeth	1.8 mm	12 in 305 mm

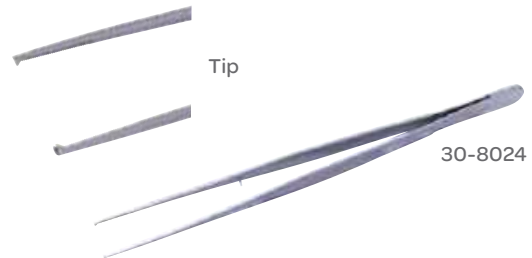

Russian Tissue Forceps

CODE	TIP WIDTH	LENGTH
30-4220	6.0 mm	6 in 152 mm
30-4221	7.0 mm	8 in 203 mm
30-4222	7.2 mm	10 in 254 mm



Bariatric Russian Tissue Forceps

CODE	DESCRIPTION	LENGTH
32-3542	1x2 Teeth	14 in 356 mm
32-3543		14 in 356 mm



Thoms-Allis Tissue Forceps

CODE	TIP WIDTH	LENGTH
30-4554	¼ in 6.0 mm	8½ in 216 mm



Thumb Tissue Forceps

Fine Tungsten Carbide Dust Tips

CODE	TIP WIDTH	LENGTH
55-9020	1.0 mm	6¼ in 159 mm
55-9028	1.0 mm	7½ in 191 mm
55-9026	2.0 mm	7½ in 191 mm
55-9034	2.0 mm	9¾ in 248 mm



Questions? Contact us at customerservice@symmetrysurgical.com
or learn more at symmetrysurgical.com

Forceps (Tissue)

Bariatric Thumb Forceps

CODE	JAW WIDTH	LENGTH
32-3541	3.4 mm	14 in 356 mm

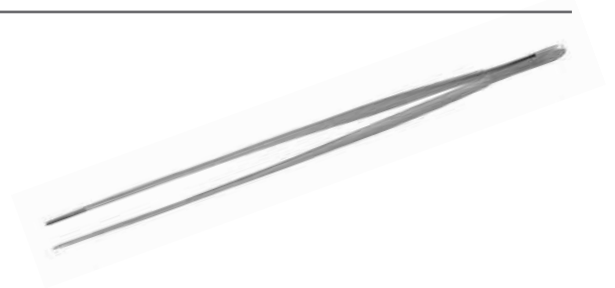

Tickner Forceps

Fine Tungsten Carbide Inserts

CODE	TIP WIDTH	LENGTH
36-6030	1.8 mm	6 in 152 mm



Tissue Forceps

CODE	DESCRIPTION	TIP WIDTH	LENGTH
30-4151	1x2 Teeth	2.3 mm	5 in 127 mm
30-4152	1x2 Teeth	2.3 mm	5½ in 140 mm
30-4153	1x2 Teeth	2.3 mm	6 in 152 mm
30-4155	1x2 Teeth	3.0 mm	8 in 203 mm
30-4156	1x2 Teeth	3.1 mm	10 in 254 mm
30-4157	1x2 Teeth	3.9 mm	12 in 305 mm
30-4161	2x3 Teeth	3.9 mm	5½ in 140 mm
32-3557	Non-Slip, Round Tip		10 in 254 mm



30-4161

Willauer-Allis Tissue Forceps

CODE	DESCRIPTION	LENGTH
30-8085	Curved	10 in 254 mm



Willauer-Allis Forceps

CODE	TEETH	LENGTH
32-3547	3x3	14 in 356 mm

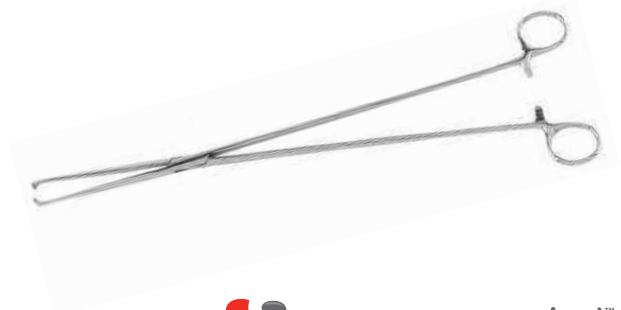

Forceps (Tube Holding)

Lore Suction Tube Holding Forceps

CODE	DESCRIPTION	LENGTH
30-1280	Tube Holding Forceps	7 in 178 mm



Forceps (Vascular)

Castaneda Vascular Forceps

Titanium, Vascular 1 x 2 Teeth, Grooved with Cross Serrations

CODE	TIP WIDTH	LENGTH
30-8500	1.7 mm	6 in 152 mm



Cooley Vascular Tissue Forceps

CODE	DESCRIPTION	TIP WIDTH	LENGTH
55-2022			6 in 152 mm
55-2023			8 in 203 mm
55-2024			9½ in 241 mm
37-4028	Fine, Cross-Serrated Jaws	1.0 mm	8 in 203 mm
55-2026	Cross Serrated Tip	1.0 mm	8 in 203 mm
55-2027	Cross Serrated Tip	1.0 mm	12 in 305 mm

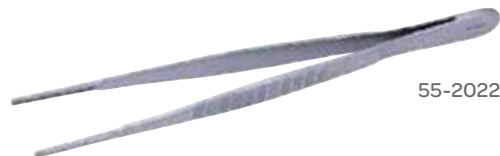

55-2022

DeBakey-Diethrich Vascular Forceps

Tips Taper from 1.5–1.3 mm for the Distal 20 mm

CODE	DESCRIPTION	LENGTH
30-8131	Vascular Forceps	6 in 152 mm
30-8132	Vascular Forceps	7¾ in 197 mm
30-8133	Vascular Forceps	9½ in 241 mm



30-8132

DeBakey-Diethrich Vascular Tissue Forceps

CODE	TIP WIDTH	LENGTH
55-2004	1.0 mm	6 in 152 mm
55-2005	1.0 mm	7¾ in 197 mm
55-2006	1.0 mm	9½ in 241 mm

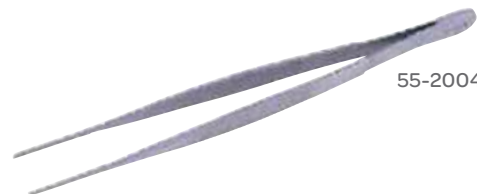

55-2004

Forceps (Vascular)

DeBakey-Liddicoat Vascular Forceps

Straight, Titanium, 1 x 2 Vascular Teeth

CODE	DESCRIPTION	TIP WIDTH	LENGTH
30-8400	Fine	1.8 mm	6 in 152 mm
30-8402	Fine	1.8 mm	7 ³ / ₄ in 197 mm
30-8404	Fine	1.8 mm	9 ¹ / ₂ in 241 mm



30-8400

DeBakey-Liddicoat Vascular Forceps

Straight, Titanium, 1 x 2 Vascular Teeth, Regular

CODE	TIP WIDTH	LENGTH
30-8401	2.25 mm	6 in 152 mm
30-8403	2.25 mm	7 ³ / ₄ in 197 mm



DeBakey Vascular Tissue Forceps

Bayonet

CODE	DESCRIPTION	TIP WIDTH	LENGTH
55-2000	Straight Tips	2.0 mm	7 in 178 mm



DeBakey Vascular Tissue Forceps

CODE	DESCRIPTION	TIP WIDTH	LENGTH
55-2007	Straight Tips	2.0 mm	6 in 152 mm
55-2008	Straight Tips	2.0 mm	7 ³ / ₄ in 197 mm
55-2009	Straight Tips	2.0 mm	9 ¹ / ₂ in 241 mm
55-2010	Straight Tips	2.0 mm	12 in 305 mm
55-2030	Straight Tips	2.0 mm	14 in 356 mm
55-2040	Straight Tips	2.0 mm	16 in 406 mm
55-2018	Straight Tips	3.0 mm	6 in 152 mm
55-2019	Straight Tips	3.0 mm	7 ³ / ₄ in 197 mm
55-2020	Straight Tips	3.0 mm	9 ¹ / ₂ in 241 mm
55-2021	Straight Tips	3.0 mm	12 in 305 mm
55-2065	Straight Tips	3.0 mm	14 in 356 mm
55-2075	Straight Tips	3.0 mm	16 in 406 mm
55-2015	Angled Tips	2.0 mm	7 ³ / ₄ in 197 mm
55-2016	Angled Tips	2.0 mm	9 ¹ / ₂ in 241 mm
55-2017	Angled Tips	2.0 mm	11 ³ / ₄ in 298 mm



55-2007

Forceps (Vascular)

DeBakey Vascular Forceps

CODE	DESCRIPTION	TIP WIDTH	LENGTH
55-2008I	Insulated	2.0 mm	7 ³ / ₄ in 197 mm
55-2009E	Ebonized	2.0 mm	9 ¹ / ₂ in 241 mm

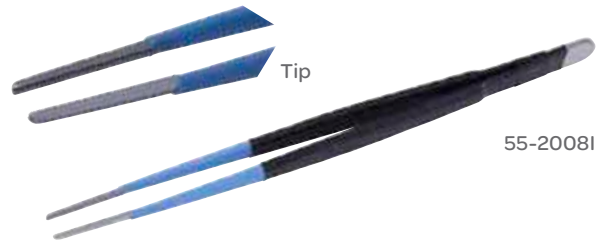

Titanium DeBakey Vascular Tissue Forceps

CODE	TIP WIDTH	LENGTH
55-2004T	1.0 mm	6 in 152 mm
55-2005T	1.0 mm	7 ³ / ₄ in 197 mm
55-2006T	1.0 mm	9 ¹ / ₂ in 241 mm
55-2007T	2.0 mm	6 in 152 mm
55-2008T	2.0 mm	7 ³ / ₄ in 197 mm
55-2009T	2.0 mm	9 ¹ / ₂ in 241 mm



Forceps (Vessel)

Vanderbilt University Vessel Forceps

CODE	DESCRIPTION	LENGTH
30-8018		8 ¹ / ₂ in 216 mm



Forceps

Barnes-Crile Classic® Forceps

CODE	DESCRIPTION	LENGTH
32-4043	Curved, Bright Finish	6 ¹ / ₄ in 159 mm



Questions? Contact us at customerservice@symmetrysurgical.com
or learn more at symmetrysurgical.com

Forceps

Bridge Forceps

CODE	DESCRIPTION	LENGTH
54-5010	Straight	11 in 279 mm
54-5009	Curved	7½ in 191 mm
54-5011	Curved	11 in 279 mm
54-5021	Curved	14 in 356 mm



54-5009

Coller Forceps

CODE	DESCRIPTION	LENGTH
30-4035	Curved	6¼ in 159 mm
16-5123	90°	9½ in 241 mm



30-4035

Cushing Forceps

Dissector End

CODE	DESCRIPTION	HANDLE	LENGTH
06-6017	Serrated	Flat Serrated	6¾ in 171 mm
06-6018	Serrated	Gutsch	7 in 178 mm
06-6087	1x2 Teeth	Flat Serrated	6¾ in 171 mm
06-6088	1x2 Teeth	Gutsch	7 in 178 mm



06-6087

Delicate Adson Classic® Hemostatic Forceps

CODE	DESCRIPTION	LENGTH
30-4464	Curved	7¼ in 184 mm



Forceps

Delicate Kocher Classic® Forceps

1x2 Teeth

CODE	DESCRIPTION	LENGTH
30-4490	Straight	5½ in 140 mm
30-4491	Curved	5½ in 140 mm



30-4490

Forceps

Extra Fine Tying Tip, Titanium, Straight

CODE	TIP WIDTH	LENGTH
80-6630	0.7 mm	6 in 152 mm

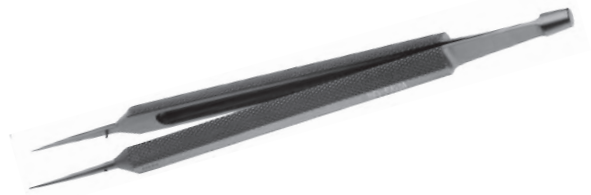

Forceps

CODE	DESCRIPTION	LENGTH
84-9067	Ceramic Coated, Ring Tip, Round Handle, Straight	7 in 178 mm



Gillies Forceps

Tips with Fine Tungsten Carbide Dust

CODE	TIP WIDTH	LENGTH
55-9016	2.0 mm	8 in 203 mm



Forceps

Harrington Forceps

CODE	DESCRIPTION	LENGTH
54-5014	Curved	12 in 305 mm



Kantrowitz Forceps

CODE	DESCRIPTION	LENGTH
54-5000	Delicate Right Angle	6½ in 165 mm
54-5003	Delicate Right Angle	7¼ in 184 mm
54-5004	Delicate Right Angle	9¾ in 248 mm
54-5012	Delicate Right Angle	10¾ in 273 mm

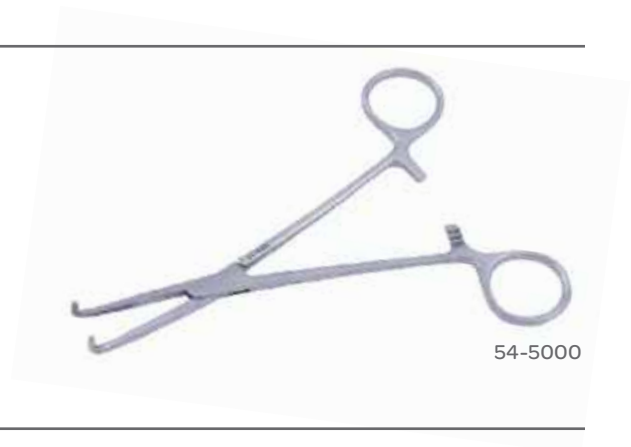

54-5000

Lahey Forceps

With Full Serrations

CODE	DESCRIPTION	LENGTH
30-4020	Straight	5½ in 140 mm
30-4021	Curved	5¾ in 146 mm



30-4020

Lawrence Forceps

CODE	DESCRIPTION	LENGTH
54-5006	Jaws Strongly Curved	7¼ in 184 mm
54-5007	Jaws Strongly Curved	11 in 279 mm



54-5006

Forceps

MagnaFree® Crile Forceps

Non-Magnetic, Titanium

CODE	DESCRIPTION	LENGTH
65-2418	Straight	5½ in 140 mm
65-2419	Curved	5½ in 140 mm



65-2418

MagnaFree® Sponge Forceps

Non Magnetic, Titanium

CODE	DESCRIPTION	LENGTH
65-2415	Straight, Serrated Jaws	9½ in 241 mm

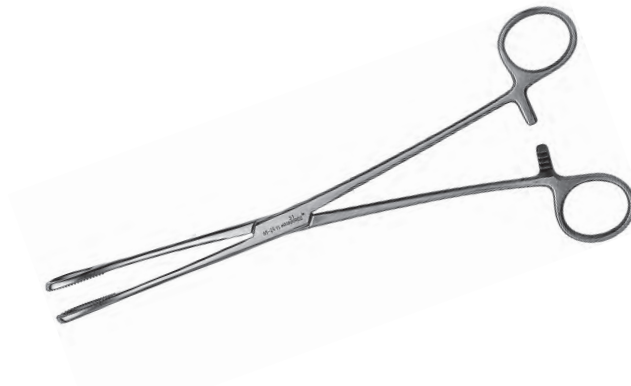

Meeker Forceps

CODE	DESCRIPTION	LENGTH
54-5005	Jaws Angled at 90°	7 in 178 mm
54-7260	Jaws Angled at 90°	10¾ in 273 mm



54-5005

Micro Forceps

Round Handle

CODE	DESCRIPTION	LENGTH
55-9040	1x2 Teeth	7¾ in 187 mm

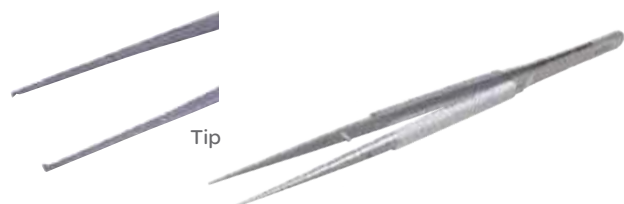

Tip

Questions? Contact us at customerservice@symmetrysurgical.com
or learn more at symmetrysurgical.com

Forceps

CVT

Mixer Forceps

CODE	DESCRIPTION	LENGTH
17-0723	Delicate	9½ in 241 mm



Pean Classic® Delicate Hemostatic Forceps

CODE	DESCRIPTION	LENGTH
30-4462	Curved	5½ in 140 mm



"Resano-Type" Forceps

CODE	DESCRIPTION	LENGTH
55-2050T	Titanium, Atraumatic Jaws	9 in 229 mm

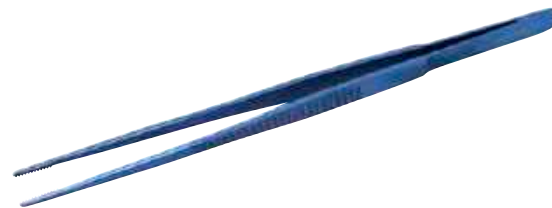

Rochester-Carmalt Forceps

CODE	DESCRIPTION	LENGTH
32-4141	Curved	6½ in 165 mm
32-4151	Curved	8 in 203 mm



Forceps

Rochester-Ochsner Forceps

CODE	DESCRIPTION	TEETH	LENGTH
32-4110	Straight	1x2	6¼ in 159 mm
32-4120	Straight	1x2	7¼ in 184 mm
32-4130	Straight	1x2	8 in 203 mm
30-8090	Straight	1x2	10 in 254 mm
32-4111	Curved	1x2	6¼ in 159 mm
32-4121	Curved	1x2	7¼ in 184 mm
32-4131	Curved	1x2	8 in 203 mm
30-8091	Curved	1x2	10 in 254 mm



30-8090

Rochester-Ochsner Classic® Forceps

CODE	DESCRIPTION	TEETH	LENGTH
33-4110	Straight, Bright Finish	1x2	6¼ in 159 mm
33-4120	Straight, Bright Finish	1x2	7¼ in 184 mm
33-4130	Straight, Bright Finish	1x2	8 in 203 mm
34-4110	Straight, Low-Glare Finish	1x2	6¼ in 159 mm
34-4120	Straight, Low-Glare Finish	1x2	7¼ in 184 mm
34-4130	Straight, Low-Glare Finish	1x2	8 in 203 mm

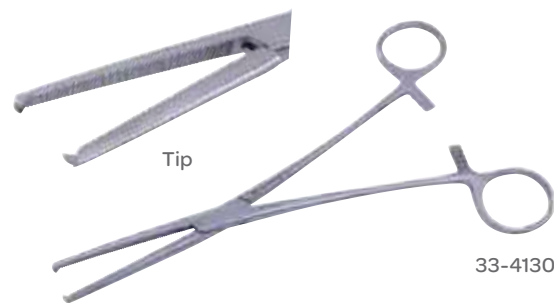

33-4130

Rochester-Pean Forceps

Cross-Serrations

CODE	DESCRIPTION	LENGTH
30-4563	Straight	9 in 229 mm
30-4565	Curved	9 in 229 mm
30-4573	Curved	10 in 254 mm



30-4563

Schmidt Forceps

CODE	DESCRIPTION	LENGTH
17-2150	One Open Ring	7½ in 191 mm



Hooks (In-Situ Bypass)

In-Situ Bypass Hook

Angled

CODE	TIP	LENGTH	
55-9072	2.0 mm Rounded	7 in	178 mm
55-9073	3.0 mm Ball	7 in	178 mm



55-9073

Hooks (Varicose Vein)

Varicose Vein Hook

CODE	DESCRIPTION	LENGTH	
13-0004	#4, 7.0 mm	5 in	127 mm



Knife Handles

Knife Handle

CODE	DESCRIPTION	LENGTH	
11-5530	No. 3	4 7/8 in	124 mm
11-5535	No. 3L	8 3/8 in	213 mm
11-5531	No. 4	5 1/4 in	133 mm
11-5534	No. 7	6 1/4 in	159 mm



11-5531

Knives (Sternum)

Lebsche Sternum Knife

CODE	BLADE LENGTH	LENGTH
40-8025	1¼ in 32 mm	9¾ in 248 mm

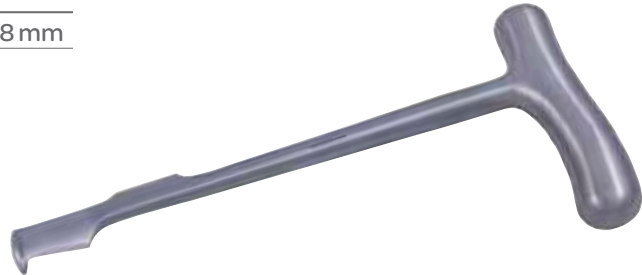

Loops (Endarterectomy)

Endarterectomy Loops

CODE	DESCRIPTION	LENGTH
55-9215	Set of 6 with Gauges Of: 20, 22, 24, 26, 28 and 30	5⅞ in 130 mm



Markers (Surgical Marker)

Surgical Marker

Gentian Violet Dye, Sterile, Disposable, Packaged with 6 inch Ruler

CODE	DESCRIPTION	QTY
43-1030	Regular Tip	36/Box
43-1032	Micro Tip	36/Box



43-1030

Questions? Contact us at customerservice@symmetrysurgical.com
or learn more at symmetrysurgical.com

Needle Holders

Jacobson Needle Holders

Straight, Titanium, Smooth Jaws

CODE	DESCRIPTION	LENGTH
80-1866		7 in 178 mm
80-1868		8½ in 216 mm
80-1867	Without Catch	7 in 178 mm
80-1869	Without Catch	8½ in 216 mm



80-1867

Jacobson Needle Holders

CODE	DESCRIPTION	LENGTH
55-2300	Heavy, Round Handle	9 in 229 mm



Slim Line Jacobson Needle Holders

Fine Tungsten Carbide Jaw Inserts, Delicate, Round Handle with Short Knurling

CODE	DESCRIPTION	LENGTH
55-2727	Straight	8¼ in 210 mm
55-2728	Straight, without Lock	8¼ in 210 mm



55-2727

Needle Holders (Micro)

Castroviejo Needle Holders

Fine Tungsten Carbide Dust Tips, Use with 5-0 and 6-0 Suture, Round Handle

CODE	DESCRIPTION	LENGTH
55-2533	Straight, with Lock	5¾ in 146 mm
55-2534	Straight, without Lock	5¾ in 146 mm



55-2533

Needle Holders (Micro)

Jacobson Micro Needle Holders

CODE	DESCRIPTION	TIP WIDTH	LENGTH
80-2002	Straight	0.5 mm	5½ in 140 mm
80-2003	Curved	0.5 mm	5½ in 140 mm



80-2002

Jacobson Micro Needle Holders

Fine Tungsten Carbide Dust Tips, Flat Knurled Handle

CODE	DESCRIPTION	LENGTH
55-2547	Straight	8 in 203 mm



Jacobson Micro Needle Holders

Fine Tungsten Carbide Dust Tips, Round Handle

CODE	DESCRIPTION	LENGTH
55-2549	Curved	9 in 229 mm



55-2549

Jacobson Micro Needle Holders

Fine Tungsten Carbide Dust Tips

CODE	DESCRIPTION	LENGTH
55-2550	Straight, Flat Handle	7 in 178 mm
55-2555	Straight, Flat Handle	7¼ in 184 mm
55-2560	Straight, Flat Handle	8¼ in 210 mm
55-2565	Straight, Flat Handle	9⅜ in 238 mm
55-2566	Straight, Flat Handle without Lock	9½ in 241 mm



Questions? Contact us at customerservice@symmetrysurgical.com
or learn more at symmetrysurgical.com

Needle Holders (Micro)

Jacobson Micro Needle Holders

Smooth, Jaws, Use with 4-0, 5-0 and 6-0 Suture, with Lock

CODE	DESCRIPTION	LENGTH	
55-2500	Straight	7 in	178 mm
55-2510	Straight	9 in	229 mm



55-2500

Jacobson Micro Needle Holders

Fine Tungsten Carbide Dust Tips, Titanium, Flat Handle

CODE	DESCRIPTION	LENGTH	
55-2555T	Straight	7¼ in	184 mm
55-2556T	Straight, Without Lock	7¼ in	184 mm
55-2565T	Straight	9 in	229 mm
55-2557T	Curved	7¼ in	184 mm
55-2558T	Curved, Without Lock	7¼ in	184 mm
55-2560T	Curved	8½ in	216 mm



55-2560T

Jacobson Micro Needle Holders

Slim Line

CODE	DESCRIPTION	LENGTH	
55-2555T-F	Straight	7¼ in	184 mm
55-2560T-F	Curved	8½ in	216 mm



55-2555T-F

Jacobson Double-Action Micro Needle Holders

Fine Tungsten Carbide Dust Tips, Use with 5-0, 6-0 and 7-0 Suture, Round Handle

CODE	DESCRIPTION	LENGTH	
55-2610	Straight	9 in	229 mm
55-2604	Straight, without Lock	7¼ in	184 mm
55-2612	Straight, without Lock	9 in	229 mm
55-2608	Curved, without Lock	7¼ in	184 mm

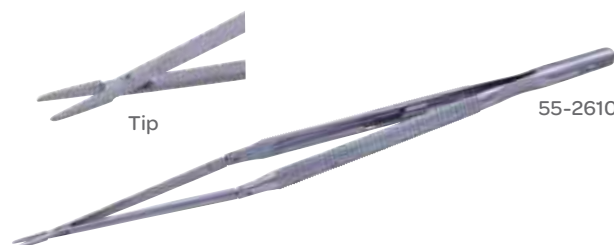

Tip

55-2610

Needle Holders (Micro)

Jacobson Micro Needle Holders

Fine Tungsten Carbide Dust Tips, Delicate, Round Handle with Short Knurling

CODE	DESCRIPTION	LENGTH
55-2527	Straight	8¼ in 210 mm
55-2531	Straight	9 in 229 mm
55-2528	Straight, without Lock	8¼ in 210 mm
55-2532	Straight, without Lock	9 in 229 mm



55-2531

Jacobson Micro Needle Holders

Titanium, Straight

CODE	DESCRIPTION	LENGTH
55-2531T	Delicate	9 in 229 mm
55-2531T-F	Slim Line	9 in 229 mm



55-2531T

Jacobson Micro Needle Holders

Fine Tungsten Carbide Dust Tips, Use with 5-0, 6-0, and 7-0 Suture, Round Handle

CODE	DESCRIPTION	LENGTH
55-2523	Straight, with Lock	7¼ in 184 mm
55-2525	Straight, with Lock	8 in 203 mm
55-2536	Straight, with Lock	9¼ in 235 mm



55-2523

Jacobson Micro Needle Holders

Fine Tungsten Carbide Dust Tips, Use with 5-0 and 6-0 Suture, Round Handle

CODE	DESCRIPTION	LENGTH
55-2524	Straight, without Lock	7¼ in 184 mm
55-2526	Straight, without Lock	8½ in 216 mm
55-2535	Straight, without Lock	9¼ in 235 mm
55-2530	Curved, without Lock	8¼ in 210 mm



55-2526

Jacobson Micro Needle Holders

Fine Tungsten Carbide Dust Tips, Use with 5-0, 6-0 and 7-0 Suture, Round Handle with Lock

CODE	DESCRIPTION	LENGTH
55-2423	Curved	7¼ in 184 mm



Questions? Contact us at customerservice@symmetrysurgical.com
or learn more at symmetrysurgical.com

Needle Holders

Baumgartner Classic Plus® Needle Holders

CODE	DESCRIPTION	LENGTH
36-2010	Tungsten Carbide Jaw Inserts	5 in 127 mm



Castroviejo Classic Plus® Needle Holders

Fine Tungsten Carbide Jaw Inserts

CODE	DESCRIPTION	LENGTH
36-1000	With Catch	5½ in 140 mm
36-1002	With Catch	7 in 178 mm
36-1001	With Catch	8½ in 216 mm



36-1000

Classic Plus® Microsurgical Needle Holders with Catch

Smooth Tungsten Carbide Jaw Inserts

CODE	DESCRIPTION	LENGTH
36-1007	With Lock	7 in 178 mm
36-1008	With Lock	8½ in 216 mm



36-1006

Combination Needle Holders & Forceps

CODE	DESCRIPTION	LENGTH
30-8002	Needle Holders and Forceps	5½ in 140 mm



Needle Holders

Crile-Wood Needle Holders

CODE	DESCRIPTION	LENGTH	
64-2509		6 in	152 mm



Crile-Wood Classic Plus® Needle Holders

CODE	DESCRIPTION	LENGTH	
36-2000	Tungsten Carbide Jaw Inserts	6 in	152 mm
36-2001	Tungsten Carbide Jaw Inserts	7 in	178 mm
36-2002	Tungsten Carbide Jaw Inserts	8 in	203 mm
36-2003	Tungsten Carbide Jaw Inserts	9 in	229 mm
36-2004	Tungsten Carbide Jaw Inserts	10 in	254 mm
36-2005	Tungsten Carbide Jaw Inserts	12 in	305 mm
32-3685	Tungsten Carbide Jaw Inserts	14 in	356 mm



36-2000

Derf Classic Plus® Needle Holders

CODE	DESCRIPTION	LENGTH	
36-1010	Tungsten Carbide Jaw Inserts	5 in	127 mm



Derf Classic Plus® Needle Holders

CODE	DESCRIPTION	LENGTH	
64-2570	Stainless Steel	5 in	127 mm



64-2570

Diethrich Needle Holders

Fine Tungsten Carbide Dust, Ring Handle, Jaw Surfaces, Use with 6-0, 7-0 and 8-0 Suture

CODE	JAW	LENGTH	
55-2570	1.0 mm	5 ¾ in	146 mm



Needle Holders

Extra Fine Needle Holders

Curved, Titanium

CODE	DESCRIPTION	TIP WIDTH	LENGTH
80-6621	Extra Fine Tip	0.5 mm	6 in 152 mm
80-6006	Fine Tip	0.7 mm	6 in 152 mm
80-6007	Standard Tip	1.0 mm	6 in 152 mm



80-6621

Halsey Needle Holders

CODE	DESCRIPTION	LENGTH
64-6558	Smooth Jaws	5 in 127 mm



64-6558

Halsey Classic Plus® Needle Holders

Fine Tungsten Carbide Jaw Inserts

CODE	DESCRIPTION	LENGTH
36-1015	Serrated Jaws	5 in 127 mm
36-1016	Smooth Jaws	5 in 127 mm



36-1015

Heaney Classic Plus® Needle Holders

Fine Tungsten Carbide Jaw Inserts

CODE	DESCRIPTION	LENGTH
36-4010	Curved Tip	8 ¼ in 210 mm



Needle Holders

Heaney Needle Holders

CODE	DESCRIPTION	LENGTH
64-2595	Standard, Curved Tip	8 ¼ in 210 mm
32-3687	Serrated, Curved Tip	14 in 356 mm



32-3687

I.M.A. Classic Plus® Needle Holders

CODE	DESCRIPTION	LENGTH
36-3018	Straight	6 in 152 mm
36-3019	Straight	7 in 178 mm



36-3018

Julian Classic Plus® Needle Holders

Fine Tungsten Carbide Jaw Inserts

CODE	DESCRIPTION	LENGTH
36-3043	Curved	8 ¼ in 210 mm
36-3042	Straight	8 ¼ in 210 mm



36-3042

MagnaFree® MRI Mayo-Hegar Needle Holders

CODE	DESCRIPTION	LENGTH
65-2414	Non-Magnetic (Titanium) For Interventional MRI	7 in 178 mm



Questions? Contact us at customerservice@symmetrysurgical.com
or learn more at symmetrysurgical.com

Needle Holders

Mayo-Hegar Classic Plus® Needle Holders

CODE	DESCRIPTION	LENGTH	
36-2015	Tungsten Carbide Jaw Inserts	5 in	127 mm
36-2016	Tungsten Carbide Jaw Inserts	6 in	152 mm
36-2017	Tungsten Carbide Jaw Inserts	7 in	178 mm
36-2018	Tungsten Carbide Jaw Inserts	8 in	203 mm
36-2019	Tungsten Carbide Jaw Inserts	10 in	254 mm
36-2020	Tungsten Carbide Jaw Inserts	12 in	305 mm
32-3686	Tungsten Carbide Jaw Inserts	14 in	356 mm



36-2015

Mayo-Hegar Needle Holders

CODE	DESCRIPTION	LENGTH	
64-2512	Stainless Steel Jaws	6 in	152 mm
64-2513	Stainless Steel Jaws	7 in	178 mm
64-2503	Stainless Steel Jaws	8 in	203 mm



64-2503

Microvascular Classic Plus® Needle Holders

CODE	DESCRIPTION	LENGTH	
36-3010	Tungsten Carbide Jaw Inserts	7 in	178 mm



Olsen-Hegar Classic Plus® Needle Holders & Scissors

CODE	DIAMETER	LENGTH	
36-4000	Tungsten Carbide Jaw Inserts	5½ in	140 mm



Needle Holders

Rogers Classic Plus® Needle Holders

Fine Tungsten Carbide Jaw Inserts

CODE	DESCRIPTION	LENGTH	
36-4011	Curved Jaws	10 ½ in	267 mm



Rubio Classic Plus® Needle Holders

Fine Tungsten Carbide Jaw Inserts, Offset Handles

CODE	DESCRIPTION	TIP	LENGTH	
36-2024	Serrated Jaw	1.14 mm	7 ⅝ in	194 mm



Ryder Needle Holders

Fine Tungsten Carbide Jaw Inserts, Use with 5-0, 6-0 and 7-0 Suture

CODE	DESCRIPTION	LENGTH	
55-2660	Ring Handle	6 ½ in	165 mm
55-2662	Ring Handle	7 ¼ in	184 mm
55-2664	Ring Handle	8 ½ in	216 mm

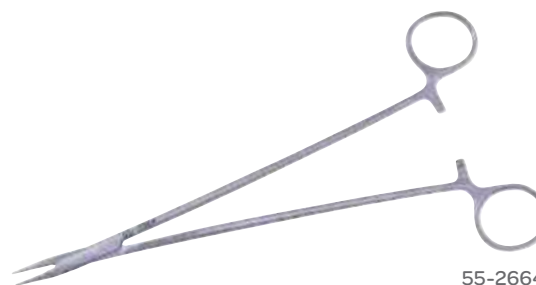

55-2664

Ryder Classic Plus® Needle Holders

Fine Tungsten Carbide Jaw Inserts, Smooth

CODE	JAW WIDTH	LENGTH	
36-3022	1.0 mm	5 in	127 mm
36-3007	1.0 mm	6 in	152 mm
36-3008	1.0 mm	7 in	178 mm
36-3009	1.0 mm	9 in	229 mm



36-3007

Questions? Contact us at customerservice@symmetrysurgical.com
or learn more at symmetrysurgical.com

Needle Holders

Ryder Classic Plus® Needle Holders

Fine Tungsten Carbide Inserts, Serrated Jaws

CODE	TIP SIZE	JAW SIZE	LENGTH
36-3023		1.0 mm	5 in 127 mm
36-3014		1.0 mm	6 in 152 mm
36-3012		1.0 mm	7 in 178 mm
36-3015		1.0 mm	8 in 203 mm
36-3013		1.0 mm	9 in 229 mm



36-3014

Ryder Classic Plus® Needle Holders

Fine Tungsten Carbide Inserts, Serrated Jaws

CODE	TIP SIZE	JAW SIZE	LENGTH
36-3000	1.5 mm	2.0 mm	5 in 127 mm
36-3001	1.5 mm	2.0 mm	6 in 152 mm
36-3002	1.5 mm	2.0 mm	7 in 178 mm
36-3003	1.5 mm	2.0 mm	8 in 203 mm
36-3004	1.5 mm	2.0 mm	9 in 229 mm
36-3005	1.5 mm	2.0 mm	10 in 254 mm



36-3000

Sarot Classic Plus® Needle Holders

CODE	DESCRIPTION	LENGTH
36-3020	Tungsten Carbide Jaw Inserts	7 in 178 mm
36-3021	Tungsten Carbide Jaw Inserts	10 in 254 mm



36-3020

Sternal Classic Plus® Needle Holders & Wire Twister

CODE	DESCRIPTION	LENGTH
36-2025	Tungsten Carbide Jaw Inserts	7 in 178 mm



Needle Holders

Stratte Classic Plus® Needle Holders

Fine Tungsten Carbide Jaw Inserts

CODE	DESCRIPTION	LENGTH
36-4015	Curved Jaw	9 in 229 mm



Thoracoscopy Needle Holders

Straight, Single Action

CODE	DIAMETER	LENGTH
54-0010	5.0 mm	8 ¼ in 210 mm

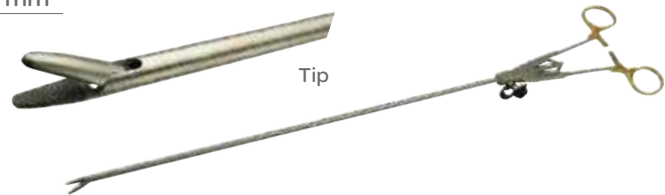

Total Occlusion Classic Plus® Needle Holders

Tungsten Carbide Inserts

CODE	DESCRIPTION	LENGTH
37-4029	Smooth Jaw	4 ¾ in 121 mm



Wangensteen Classic Plus® Needle Holders

CODE	DESCRIPTION	LENGTH
36-4020	Tungsten Carbide Jaw Inserts	10 ½ in 267 mm



Questions? Contact us at customerservice@symmetrysurgical.com
or learn more at symmetrysurgical.com

Needles

Heparin Needle

CODE	DESCRIPTION
54-6000	2.9 mm Olive Tip
54-6016	3.7 mm Tip Medium



54-6000

Heparin Tip Needles

2/Each

CODE	DESCRIPTION	LENGTH
45-8002	Needle	1 7/8 in 48 mm



Obturators

Rumel Obturator

CODE	DESCRIPTION
55-5499	Child
55-5498	Adult



Pliers

Vice Grips

CODE	DESCRIPTION	LENGTH
37-4101	Vice Grips	7 in 178 mm



Pliers

Heavy Duty Lock Pliers

CODE	TIP WIDTH	LENGTH
32-3337	9.0 mm	8 in 203 mm



Needle Nose Pliers

CODE	DESCRIPTION	LENGTH
32-3339	Wire Notch	5½ in 140 mm
37-4100	Wire Notch	6¼ in 159 mm



32-3339

Pliers

CODE	DESCRIPTION	LENGTH
37-4102	Serrated Jaws	6½ in 165 mm



Punches (Sternal Punch)

Sweet Sternal Punch

CODE	DESCRIPTION	LENGTH
51-8006	Hook to Carry Suture Back Through Hole	9½ in 241 mm



Raspatory

Alexander-Farabeuf Rib Raspatory

CODE	DESCRIPTION	LENGTH	
54-3134	Pediatric	6 in	152 mm
54-3135	Adult	8 ¼ in	210 mm



54-3135

Davidson-Alexander Rib Raspatory

CODE	DESCRIPTION	LENGTH	
54-3140	Double-Ended	11 ¾ in	289 mm



Doyen Rib Raspatory

CODE	DESCRIPTION	BLADE LENGTH	LENGTH	
54-3002	Left, Pediatric		6 in	152 mm
54-3001	Right, Pediatric		6 in	152 mm
52-8000	Left, Sharp	1 ⅛ in 29 mm	7 in	178 mm
52-8001	Right, Sharp	1 ⅛ in 29 mm	7 in	178 mm
54-3012	Right, Adult		6 ¾ in	171 mm



52-8000

Matson Rib Raspatory

Double-Ended

CODE	ELEVATOR BLADE	LENGTH	
54-3130	15 mm Wide, Stripper End 22 mm Wide	8 ¾ in	222 mm



Semb Raspatory

CODE	DESCRIPTION	LENGTH	
54-4001	Angled, With Notch	8 in	203 mm
54-4002	Angled, With Notch	9 ¼ in	235 mm
54-4003	Angled, Straight Edge	8 in	203 mm
54-4006	Curved, Round Blade	8 ½ in	216 mm



54-4001

Retractors (Aorta)



Crawford Aorta Retractor

CODE	DESCRIPTION	TIP WIDTH
55-8008	Small Blade	15 mm

Retractors (Aortic Valve)



50-8012

Liddicoat Aortic Valve Retractor

CODE	DESCRIPTION	BLADE (W X L)	LENGTH
50-8012	Large Aortic Valve Retractor	$\frac{3}{4}$ x $1\frac{1}{8}$ in 19 x 29 mm	$7\frac{3}{4}$ in 197 mm
50-8011	Small Aortic Valve Retractor	$\frac{3}{8}$ x $\frac{3}{4}$ in 10 x 19 mm	$7\frac{3}{4}$ in 197 mm

Retractors (Appendectomy)



50-4130C

Richardson Retractor

CODE	DESCRIPTION	LENGTH
50-4131	Ring-Grip Handle	$\frac{3}{4}$ in 19 mm
50-4130C	Standard Handle	$1\frac{3}{16}$ in 21 mm

Retractors (Atrial Valve)

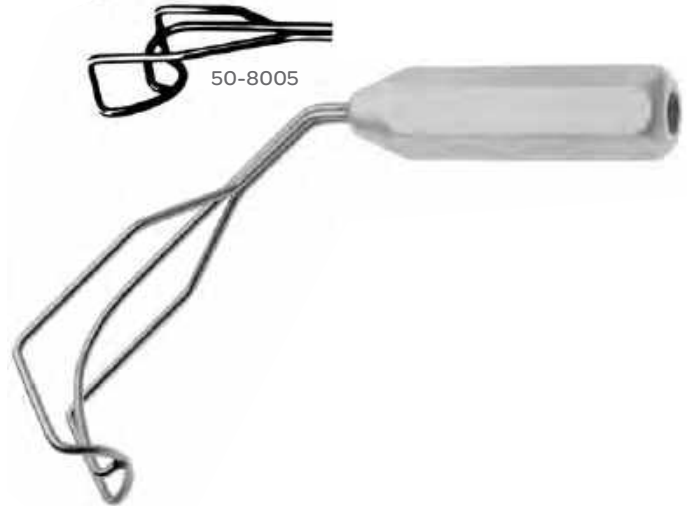
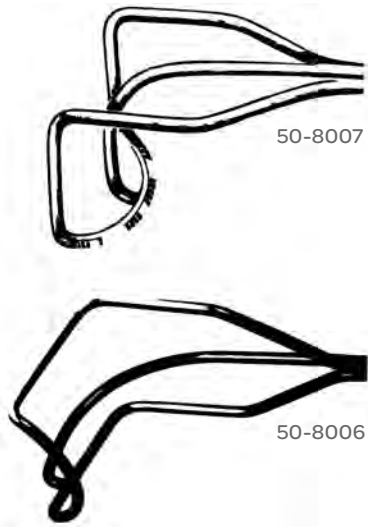

Cooley Atrial Retractor

CODE	DESCRIPTION	BLADE (W X D)		LENGTH	
50-8005	Left	1 ³ / ₄ x 1 in	44 x 25 mm	10 in	254 mm
50-8007	Modified with Teeth	1 ³ / ₄ x 1 ³ / ₄ in	44 x 44 mm	10 in	254 mm
50-8006	Right	1 ³ / ₄ x 1 in	44 x 25 mm	10 in	254 mm
55-8002	Right, Medium Blade	1 ⁵ / ₈ x 1 ³ / ₁₆ in	41 x 30 mm	10 in	254 mm

Retractors (Blades)



Turner-Doyen Retractor

CODE	DESCRIPTION	WIDTH		LENGTH	
32-3628	Blade Retractor	2 ³ / ₈ in	60 mm	5 ¹ / ₂ in	140 mm

Bookwalter® Horizontal Bars

Bookwalter® Lightweight Horizontal Bar

CODE	DESCRIPTION	LENGTH
50-4552	Horizontal Bar	14 ¼ in 362 mm



Bookwalter® Lightweight Horizontal Flex Bar

CODE	DESCRIPTION
50-4582	Horizontal Flex Bar, 360° rotation



Bookwalter® Lightweight Horizontal Flex Bar

CODE	DESCRIPTION
50-4618	Horizontal Bar, Lightweight Design that can be Back Feed into the Bookwalter® Coupler



Bookwalter® Lightweight Extension Bar

CODE	DESCRIPTION	DIMENSION
50-4553	Lightweight Extension Bar	12 in 305 mm
50-4797	Lightweight Extension Bar	18 in 458 mm



50-4553 and 50-4797 require the use of a second Bookwalter® Post Coupler 50-4554

50-4553

Bookwalter® Ironman

CODE	DESCRIPTION
50-4678	Horizontal Ring Holder

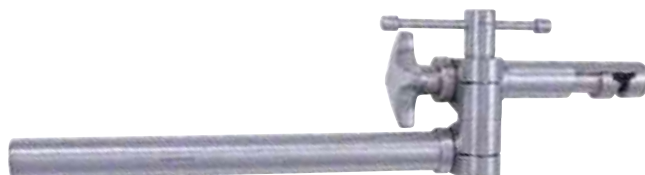

Questions? Contact us at customerservice@symmetrysurgical.com
or learn more at symmetrysurgical.com

Bookwalter® Retractor Blades

Bookwalter® Balfour Blade

CODE	DESCRIPTION	DIMENSIONS (W X L)	
50-4576	Balfour Blade	2 5/8 x 3 in	67 x 76 mm
BW1271017	Balfour Blade	3 1/2 x 2 3/4 in	89 x 70 mm



50-4576

Bookwalter® Harrington Blade

CODE	DESCRIPTION	DIMENSIONS (W X L)	
50-4566	Harrington Blade	2 1/2 x 5 5/8 in	64 x 143 mm
BW1045176	Harrington Blade		



50-4566

Bookwalter® Kelly Blade

CODE	DIMENSIONS (W X L)		CODE	DESCRIPTION	DIMENSIONS (W X L)	
50-4568	2 x 3 in	51 x 76 mm	50-4574		1 x 1 1/2 in	25 x 38 mm
50-4569	2 x 4 in	51 x 102 mm	50-4575		1 x 2 1/2 in	25 x 63 mm
50-4570	2 x 5 in	51 x 127 mm	BW1045000		2 x 8 in	51 x 203 mm
50-4571	2 x 6 in	51 x 152 mm	50-4565	Modified	2 x 1 1/2 in	51 x 38 mm
50-4572	2 x 5 in	51 x 127 mm				



50-4568

Bookwalter® Richardson Blade

CODE	DESCRIPTION	DIMENSIONS (W X L)	
50-4597	Blade	3/4 x 1 in	19 x 25 mm
50-4598	Blade	3/4 x 2 in	19 x 51 mm
50-4599	Blade	1 x 1 1/4 in	25 x 32 mm



50-4598

Bookwalter® Retractor Blades

Bookwalter® Opti-Length® Malleable Blades

CODE	DESCRIPTION	DIMENSIONS (W X L)	
67-7499	Malleable with Lip, Ebonized	3 x 11 in	76 x 279 mm
67-7500	Malleable with Lip, Ebonized	4 x 11 in	102 x 279 mm
67-7502	Malleable with Lip, Ebonized	1½ x 11 in	38 x 279 mm
67-7504	Malleable with Lip, Ebonized	2 x 11 in	51 x 279 mm



67-7499

Bookwalter® Retractor Blade

Malleable

CODE	DIMENSIONS (W X L)		CODE	DIMENSIONS (W X L)	
50-4562	1½ x 6 in	38 x 152 mm	50-4567	3 x 6 in	76 x 152 mm
50-4561	2 x 6 in	51 x 152 mm	BW1043029	3 x 10 in	76 x 254 mm
BW1043016	2 x 10 in	51 x 254 mm			



50-4561

Bookwalter® Retractor Blade

CODE	DESCRIPTION	DIMENSIONS (W X L)	
50-4694	Bookwalter® Malleable Blade with Lip	1 x 4 in	25 x 102 mm
50-4672	Bookwalter® Malleable Blade with Lip	1½ x 6 in	38 x 152 mm
50-4673	Bookwalter® Malleable Blade with Lip	2 x 6 in	51 x 152 mm
50-4674	Bookwalter® Malleable Blade with Lip	3 x 6 in	76 x 152 mm



50-4672

Bookwalter® Super Malleable Blade With Lip

A malleable blade with a softer flex and tension

CODE	DESCRIPTION	DIMENSIONS (W X L)	
50-4691	Super Malleable with Lip	1 x 4 in	25 x 102 mm
50-4669	Super Malleable with Lip	1½ x 6 in	38 x 152 mm
50-4670	Super Malleable with Lip	2 x 6 in	51 x 152 mm
50-4671	Super Malleable with Lip	3 x 6 in	76 x 152 mm



50-4669

Bookwalter®

Bookwalter® Radiolucent Titanium Blade

Low Glare Gold Coating

CODE	DESCRIPTION	DIMENSIONS (W X L)		CODE	DESCRIPTION	DIMENSIONS (W X L)	
505580	Titanium Blade	1 x 4 in	25 x 102 mm	505585	Titanium Blade	2 x 4 in	51 x 102 mm
505581	Titanium Blade	1 x 5 in	25 x 127 mm	505586	Titanium Blade	2 x 5 in	51 x 127 mm
505582	Titanium Blade	1 x 6 in	25 x 152 mm	505587	Titanium Blade	2 x 6 in	51 x 152 mm
505583	Titanium Blade	1 x 7 in	25 x 178 mm	505588	Titanium Blade	2 x 7 in	51 x 178 mm
505584	Titanium Blade	1 x 8 in	25 x 203 mm	505589	Titanium Blade	2 x 8 in	51 x 203 mm



505580

Bookwalter® Gelpi Retractor

CODE	DESCRIPTION
50-4577	Bookwalter® Gelpi Point (Sharp)



Retractors (Bookwalter® Coupler)

Bookwalter® Lightweight Post Coupling

CODE	DESCRIPTION	LENGTH	
50-4554	Lightweight Post Coupling for Standard 1 in (25 mm) System	1 x 4 in	25 x 102 mm



Bookwalter® Retractor Sets

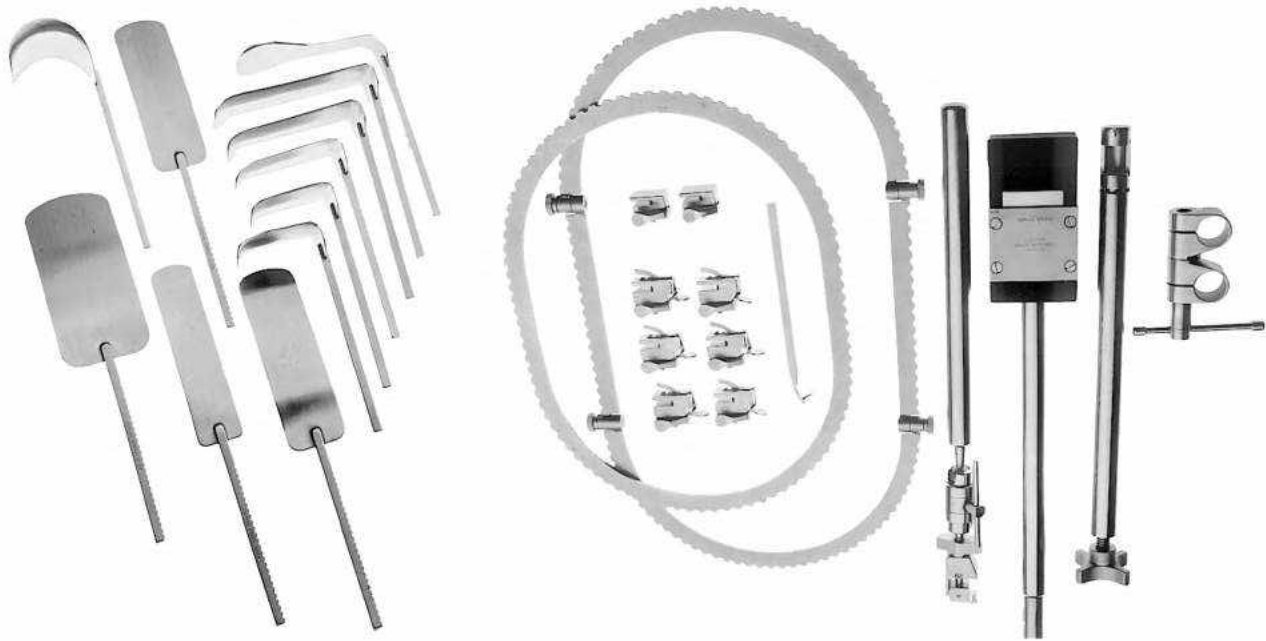

Bookwalter® Retractor Kit II

CODE	DESCRIPTION	QUANTITY
50-4542	Includes Part Numbers and Quantities Listed Below:	
50-4581	Table Post	1
50-4554	Post Coupling	1
50-4552	Horizontal Bar	1
50-4582	Horizontal Flex Bar	1
50-4557	Medium Oval Ring	1
50-4583	Segmented Ring	1
50-4579	Ratchet Mechanisms	2
50-4580	Tilt Ratchet Mechanisms	6
50-4579	Ratchet Mechanisms	2
50-4580	Tilt Ratchet Mechanisms	6
50-4566	Harrington Retractor	1
50-4576	Balfour Retractor	1
50-4568	Kelly Retractors, 2 x 3 in (51 x 76 mm)	2
50-4569	Kelly Retractor, 2 x 4 in (51 x 102 mm)	1
50-4570	Kelly Retractor 2 x 5 in (51 x 127 mm)	1
50-4571	Kelly Retractor 2 x 6 in (51 x 152 mm)	1
50-4562	Malleable Retractor 1½ x 6 in (38 x 152 mm)	1
50-4561	Malleable Retractors, 2 x 6 in (51 x 152 mm)	2
50-4567	Malleable Retractor 3 x 6 in (76 x 152 mm)	1
50-4577	Gelpi Retractor	1
ACCESSORIES		
50-4507	Table Fixation & Ring Case	1
50-4508	Blade & Accessories Case	1

Questions? Contact us at customerservice@symmetrysurgical.com
or learn more at symmetrysurgical.com

Bookwalter® Retractor Sets

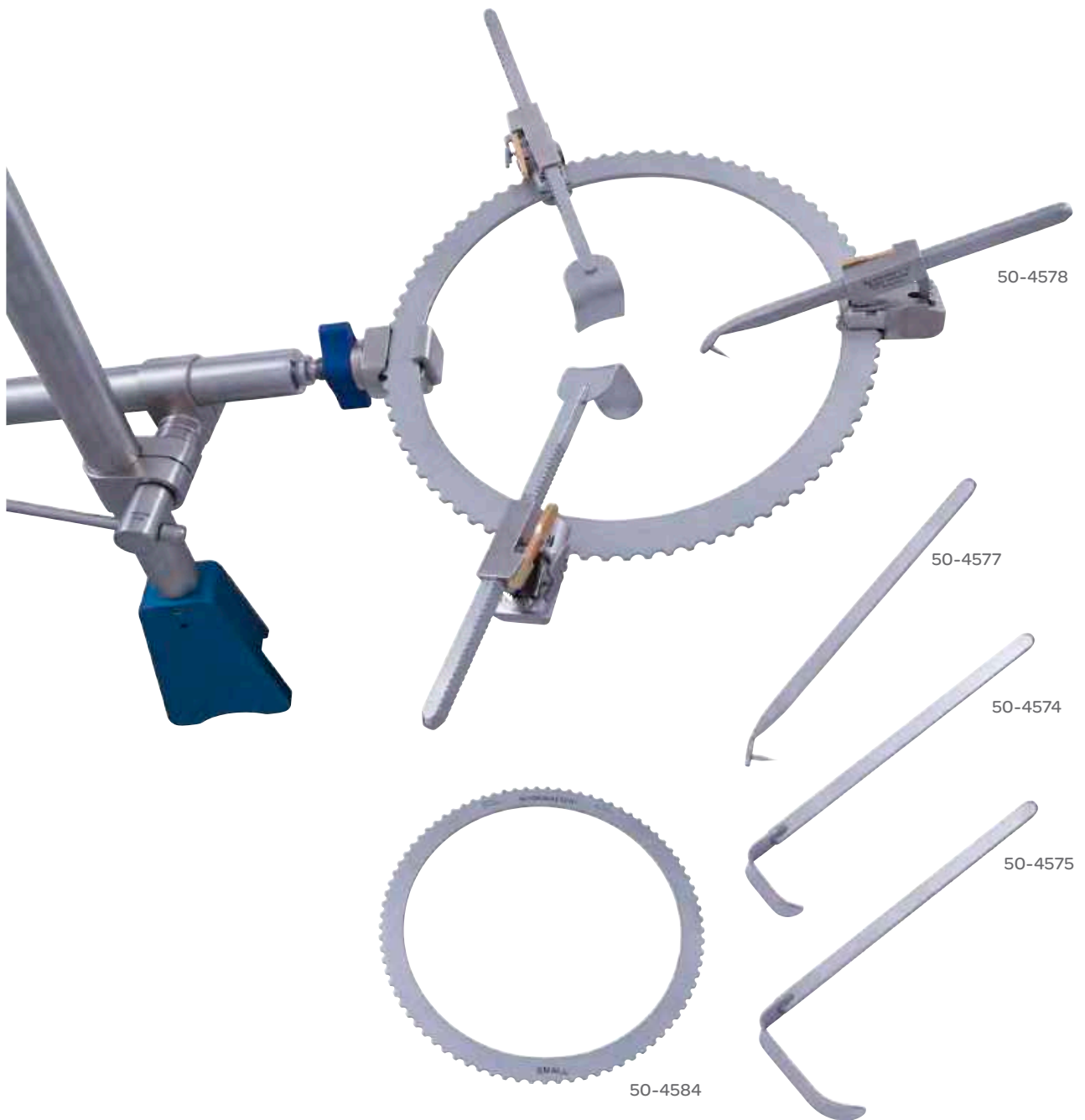

Bookwalter® Small Incision Kit

CODE	DESCRIPTION	LENGTH	
50-4578	Includes Part Numbers Listed Below:		
50-4584	Round Ring	8½ in	216 mm
50-4577	Retractor Gelpi Blade		
50-4574	Kelly Retractor Blades	1 x 1½ in	25 x 38 mm
50-4575	Kelly Blade	1 x 2½ in	25 x 64 mm

Bookwalter® Retractor Sets

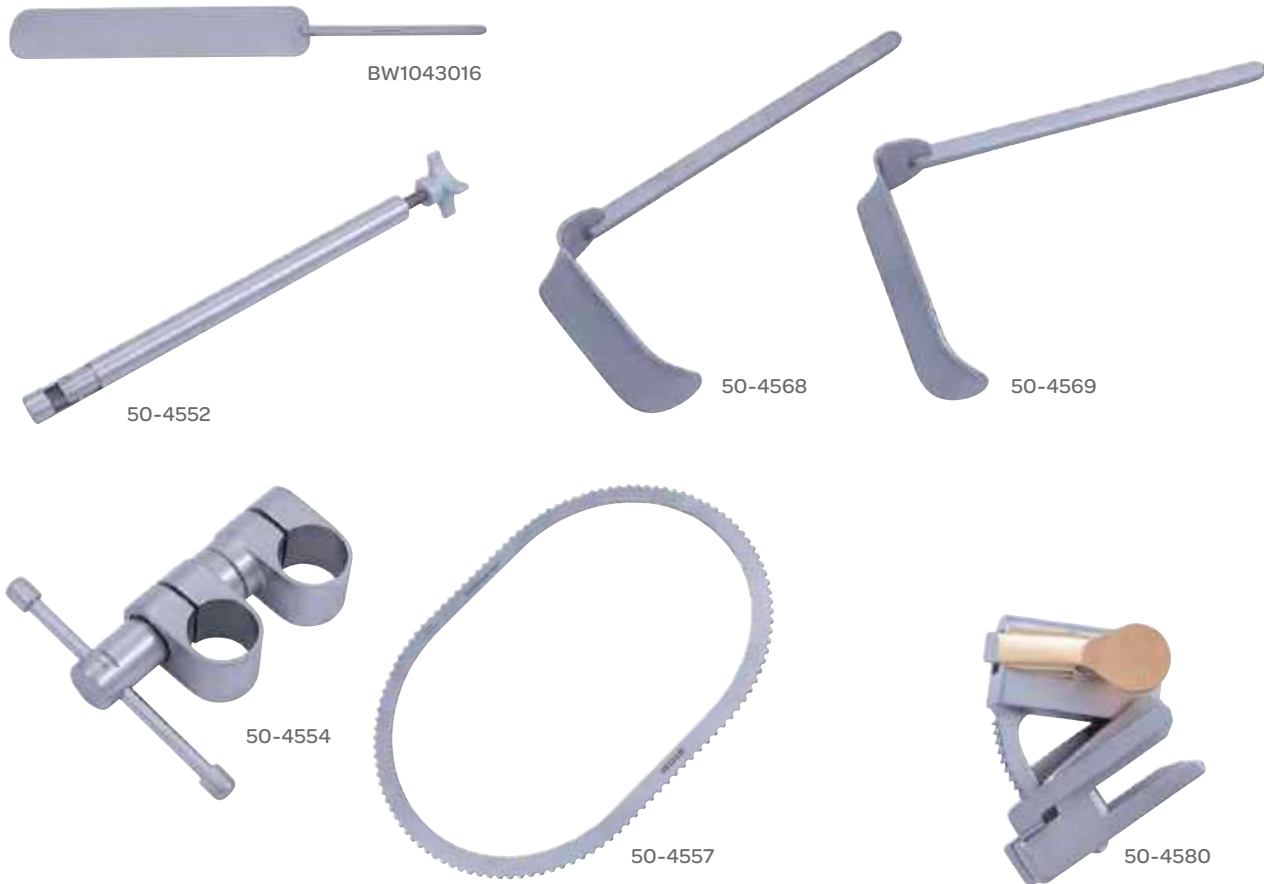

Bookwalter® Obese Patient Retractor System, 18 Inch (458 mm) Table Post

CODE	DESCRIPTION	LENGTH	QUANTITY
BW1046BKIT	Includes Part Numbers Listed Below:		
BW0144005	Table Post Obese Patients		1
BW1043016	Malleable Blade	2 x 10 in 51 x 254 mm	1
BW1043029	Malleable Blade	3 x 10 in 76 x 254 mm	1
BW1045069	Malleable Blade	4 x 8 in 102 x 203 mm	1
BW1045000	Kelly Blade	2 x 8 in 51 x 203 mm	1
BW1271017	Balfour Blade	3 ½ x 2 ¾ in 89 x 70 mm	1
BW1045176	Harrington Blade	3 ½ x 10 in 89 x 254 mm	1
BW0338014	Ratchet Extender		1
BW0338015	Twister Ratchet		1
50-4552	Retractor Horizontal Bar		1
50-4554	Post Coupling	1 x 1 in 25 x 25 mm	1
50-4557	Retractor, Oval Ring Medium		1
50-4568	Kelly Retractor Blades	2 x 3 in 51 x 76 mm	1
50-4569	Kelly Retractor Blades	2 x 4 in 51 x 102 mm	1
50-4580	Tilting Ratchets		6

Questions? Contact us at customerservice@symmetrysurgical.com
or learn more at symmetrysurgical.com

Bookwalter® Retractor Sets



Bookwalter® Obese Patient Retractor System, 24 Inch (610 mm) Table Post

CODE	DESCRIPTION	LENGTH	QUANTITY
BW1045BKIT	Includes Part Numbers Listed Below:		
BW0144003	Table Post		1
BW1043016	Malleable Blade	2 x 10 in 51 x 254 mm	1
BW1043029	Malleable Blade	3 x 10 in 76 x 254 mm	1
BW1045069	Malleable Blade	4 x 8 in 102 x 203 mm	1
BW1045000	Kelly Blade	2 x 8 in 51 x 203 mm	1
BW1271017	Balfour Blade	3 ½ x 2 ¾ in 89 x 70 mm	1
BW1045176	Harrington Blade	3 ½ x 10 in 89 x 254 mm	1
BW0338014	Ratchet Extender		1
BW0338015	Twister Ratchet		1
50-4552	Horizontal Bar		1
50-4554	Post Coupling	1 x 1 in 25 x 25 mm	1
50-4557	Medium Oval Ring		1
50-4568	Kelly Blade	2 x 3 in 51 x 76 mm	1
50-4569	Kelly Blade	2 x 4 in 51 x 102 mm	1
50-4580	Tilt Ratchets		6

Bookwalter® Retractor Sets



Bookwalter® Obese Patient Accessory Kit, 18 Inch (458 mm) Table Post

CODE	DESCRIPTION	LENGTH		QUANTITY
BW1046BRT	Includes Part Numbers Listed Below:			
BW0144005	Table Post			1
BW1043016	Malleable Blade	2 x 10 in	51 x 254 mm	1
BW1043029	Malleable Blade	3 x 10 in	76 x 254 mm	1
BW1045069	Malleable Blade	4 x 8 in	102 x 203 mm	1
BW1045000	Kelly Blade	2 x 8 in	51 x 203 mm	1
BW1271017	Balfour Blade	3 ½ x 2 ¾ in	89 x 70 mm	1
BW1045176	Harrington Blade	3 ½ x 10 in	89 x 254 mm	1
BW0338014	Ratchet Extender			1
BW0338015	Twister Ratchet			1



Bookwalter® Obese Patient Accessory Kit, 24 Inch (610 mm) Table Post

CODE	DESCRIPTION	LENGTH		QUANTITY
BW1045BRT	Includes Part Numbers Listed Below:			
BW0144003	Table Post			1
BW1043016	Malleable Blade	2 x 10 in	51 x 254 mm	1
BW1043029	Malleable Blade	3 x 10 in	76 x 254 mm	1
BW1045069	Malleable Blade	4 x 8 in	102 x 203 mm	1
BW1045000	Kelly Blade	2 x 8 in	51 x 203 mm	1
BW1271017	Balfour Blade	3 ½ x 2 ¾ in	89 x 70 mm	1
BW1045176	Harrington Blade	3 ½ x 10 in	89 x 254 mm	1
BW0338014	Ratchet Extender			1
BW0338015	Twister Ratchet			1

Bookwalter® Retractor Sets

Bookwalter® Richardson Blade Kit

CODE	DESCRIPTION	LENGTH	
50-4596	Includes 1 each of the following three codes:		
50-4597	Blade	¾ x 1 in	19 x 25 mm
50-4598	Blade	¾ x 2 in	19 x 51 mm
50-4599	Blade	1 x 1¼ in	25 x 32 mm



Bookwalter® I.M.A. T Bar

For use with the Bookwalter® I.M.A. System

CODE	DESCRIPTION
50-4675	Bookwalter® I.M.A., T Bar



Bookwalter® I.M.A. Retractor System

Provides The Tools To Elevate And Retract The Sternum For Efficient Dissection Of The Internal Mammary Artery

CODE	DESCRIPTION	LENGTH		QUANTITY
50-4600	Includes Part Numbers Listed Below:			
50-4552	Horizontal Bar			1
50-4554	Coupler	1 x 1 in	25 x 25 mm	1
50-4581	Table Post	12 in	305 mm	1
50-4601	I.M.A. Cross Bar	12 in	305 mm	1
50-4602	I.M.A. Ratchet			2
50-4603	I.M.A. Rake Retractor, Sharp			2
50-4604	I.M.A. Retractor Case			1



50-6000

Bookwalter® Ratchets

Bookwalter® Ratchet Mechanism

CODE	DESCRIPTION	QTY
50-4579	Basic Ratchet provides simple retraction at 0° angle to the surgical site.	1/Each Sold Individually



Bookwalter® Tilt Ratchet Mechanism

CODE	DESCRIPTION	QTY
50-4580	Tilt ratchet articulates the blade into the surgical site.	1/Each Sold Individually



Bookwalter Rotilt® Ratchet

CODE	DESCRIPTION	QTY
50-4589	The RoTilt Ratchet twists the blade in 7 indexed positions along a 60° arch and has the ability to independently articulate the blade into the surgical site.	1/Each Sold Individually



Bookwalter® Self-Retaining Tilt Ratchet

CODE	DESCRIPTION	QTY
50-4686	Like the 50-4580 this ratchet articulates the blade into the surgical site, it also has an additional self retention latch that holds the ratchet onto the Bookwalter® Retractor Ring.	1/Each Sold Individually



Questions? Contact us at customerservice@symmetrysurgical.com
or learn more at symmetrysurgical.com

Bookwalter® Ratchets

Bookwalter® Self-Retaining Low Profile Locking Rotilt

CODE	DESCRIPTION	QTY
50-4696	The Bookwalter® Self Retaining Low Profile Locking RoTilt Ratchet bring all of the best features of all other ratchets into one mechanism. The low profile design, inclusive of the capacity to tilt, rotate and self retention it is the one ratchet to build your Bookwalter® Set.	1/Each Sold Individually



Bookwalter® Twister Ratchet

CODE	DESCRIPTION	QTY
BW0338015	The Bookwalter® Twister Ratchet is compatible with all Bookwalter® Ratchets and Retractor Blades. It allows controlled fine tuning of blade position with the simple turn of the key.	1/Each Sold Individually



Bookwalter® Ratchet Extender

CODE	DESCRIPTION
BW0338014	A Bookwalter® Extender provides the surgeon with the extra length that is sometimes needed to get a blade positioned in 'just the right spot.' Can be used with any Bookwalter® Retractor.



Retractors (Bookwalter® Systems)

Bookwalter® Adaptable Ring System

Table Mounted

CODE	DESCRIPTION
504810	System includes the Horizontal Bar and dual ball joint hinge system as well as the Small Round, Medium Round and Medium Oval Ring Segments.
504811	Small Round Ring Segments
504812	Medium Round Ring Segments
504813	Medium Oval Ring Segments



504810

Bookwalter® Adaptable Ring System Bridge

CODE	DESCRIPTION
504687	For use with 50-4810



Bookwalter® Rings

Bookwalter® Elliptical Ring

For Obese Patients

CODE	DESCRIPTION	LENGTH
50-4595	Segmented	14 ½ in x 15 in 368 w x 381 mm



Questions? Contact us at customerservice@symmetrysurgical.com
or learn more at symmetrysurgical.com

Bookwalter® Rings

Bookwalter® Oval Ring

CODE	DESCRIPTION	LENGTH	
50-4558	Small, Table Mounted	8 x 12 ¼ in	203 x 311 mm
50-4557	Medium, Table Mounted	10 ½ in x 14 ½ in	267 x 368 mm
50-4556	Large, Table Mounted	12 x 18 ½ in	305 x 470 mm



50-4558

Bookwalter® Round Ring Segmented

Table Mounted

CODE	DESCRIPTION	LENGTH	
50-4635	Small, 1 Pair	8 ½ in	216 mm
50-4634	Medium, 1 Pair	10 ½ in	267 mm
50-4633	Large, with Suture Slots	16 in	406 mm



Bookwalter® Round Ring

CODE	DESCRIPTION	LENGTH (INNER DIMENSION)	
50-4584	Small, Table Mounted	8 ½ in	216 mm
50-4559	Medium, Table Mounted	10 ½ in	267 mm
50-4560	Large, Table Mounted	12 ½ in	318 mm



50-4559

Bookwalter® Suture Ring

CODE	DESCRIPTION	LENGTH	
50-4684	Round, Small	9 ½ in	241 mm



50-4684

Bookwalter® Rings

Bookwalter® Segmented Retractor Ring

CODE	DESCRIPTION	DIMENSIONS	
50-4587	Small, Consists of One 8 ½ in Round Ring and Two 4 in Straight Segments	8 ½ x 14 in	216 x 356 mm
50-4583	Medium, Consists of One 10 ½ in Round Ring and Two 8 in Straight Segments	10 ½ x 19 ½ in	267 x 495 mm
50-4588	Large, Consists of One 12 ½ in Round Ring and Two 6 in Straight Segments	12 ½ x 19 ½ in	318 x 495 mm



50-4587

Bookwalter® Segmented Ring (Straight Segments)

CODE	DESCRIPTION	LENGTH	
50-4636	Straight Ring Segment (Pair)	4 in	102 mm
50-4637	Straight Ring Segment (Pair)	6 in	152 mm
50-4638	Straight Ring Segment (Pair)	8 in	203 mm



50-4637

Bookwalter® Universal Ring Segmented Ring Screw

CODE	DESCRIPTION	LENGTH	
58-0093X	Table Mounted	8 ½ x 14 in	216 x 356 mm



Questions? Contact us at customerservice@symmetrysurgical.com
or learn more at symmetrysurgical.com

Bookwalter® Table Posts

Violi Gooseneck Table Post

CODE	DESCRIPTION
50-4681	For 1 in (25 mm) System

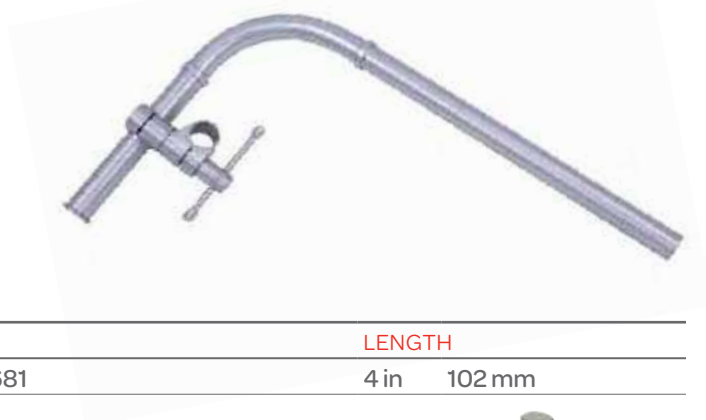

Bookwalter® Violi Post Holder

CODE	DESCRIPTION	LENGTH
50-4680	For Use with the Violi Gooseneck 50-4681	4 in 102 mm



Bookwalter® Table Post

CODE	DESCRIPTION	LENGTH
50-4683	For 1 in (25 mm) System	8 in 203 mm
50-4581	Table Post	12 in 305 mm
BW0144005	Table Post	18 in 458 mm
BW0144003	Table Post	24 in 610 mm



50-4581

Bookwalter® Lightweight Table Post

CODE	DESCRIPTION	LENGTH
504688	Lightweight Table Post	12 in 305 mm
504697	Lightweight Table Post	16 in 406 mm



50-4688

Retractors (Vision)

Ultra™ Swivel Blade

CODE	DESCRIPTION	LENGTH	
59-8816A	Table Mounted	1 in	25 mm



Ultra™ Blade Loading Locking Retractor Handle

CODE	DESCRIPTION	LENGTH	
59-0105	Table Mounted	8 in	203 mm



Retractors (Abdominal)

Universal Ring Big Boy Retractor Blade

CODE	DESCRIPTION	LENGTH	
58-0021	Fenestrated blade	18 in	458 mm
58-0020	Fenestrated blade	24 in	610 mm



58-0020

Questions? Contact us at customerservice@symmetrysurgical.com
or learn more at symmetrysurgical.com

Retractors (Abdominal)

Universal Ring Harrington Retractor Blade

CODE	DESCRIPTION	DIMENSIONS	
58-0035	Solid	$\frac{2}{3}$ x 2 $\frac{1}{4}$ in	15 x 57 mm
58-0037	Solid	3 x 10 $\frac{1}{2}$ in	76 x 267 mm



58-0035

Universal Ring Kelly Retractor Blade

CODE	DESCRIPTION	LENGTH	
58-0025	Table Mounted	1 x 3 in	25 x 76 mm
58-0009	Table Mounted	2 $\frac{1}{2}$ x 5 x 3 $\frac{1}{2}$ in	64 x 127 x 89 mm
58-0017T	Titanium, Table Mounted	2 $\frac{1}{2}$ x 8 x 3 $\frac{1}{2}$ in	64 x 203 x 89 mm
58-0016T	Titanium, Table Mounted	3 x 10 $\frac{1}{2}$ in	76 x 267 mm



58-0009

Universal Ring Pediatric Harrington Retractor Blade

CODE	DESCRIPTION	LENGTH	
58-0036	Table Mounted	2 x 8 in	51 x 203 mm

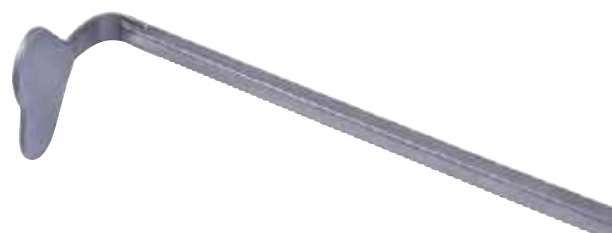

Retractors (Abdominal)

Universal Ring Retractor Blade

CODE	DESCRIPTION	LENGTH
58-0073	Table Mounted, Fence, Rigid	2 x 3 $\frac{3}{4}$ in 51 x 95 mm
58-0044T	Table Mounted, Titanium	3 $\frac{1}{2}$ x 3 $\frac{3}{4}$ in 89 x 95 mm



58-0073

Universal Ring Yu-Holtgrew Retractor Blade

CODE	DESCRIPTION	LENGTH
58-0022	Table Mounted	4 x 5 in 102 x 127 mm

Universal Ring Retractor Blade

CODE	DESCRIPTION	LENGTH
58-0040	Table Mounted, Malleable, with Protective Edge	$\frac{3}{4}$ x 4 in 19 x 102 mm
58-0045	Table Mounted, Malleable, with Protective Edge	2 x 8 in 50 x 203 mm
58-0049	Table Mounted, Malleable, with Protective Edge	3 x 8 in 76 x 203 mm
58-0054	Table Mounted, Malleable, with Protective Edge	6 x 9 in 152 x 279 mm
58-0056	Table Mounted, Malleable, with Protective Edge	4 x 10 in 102 x 254 mm



58-0040

Questions? Contact us at customerservice@symmetrysurgical.com
or learn more at symmetrysurgical.com

Retractors (Abdominal)

Universal Ring Retractor Blade

CODE	DESCRIPTION	LENGTH
58-0057N	Table Mounted, Malleable	3 x 6 in 76 x 152 mm
58-0044N	Table Mounted, Malleable	2 x 6 in 50 x 152 mm



58-0057N

Universal Ring Elliptical

CODE	DESCRIPTION	LENGTH
58-0100	Table Mounted, Segmented	4 x 10 in 102 x 254 mm



Ultra™ Mayo Swivel Blade

CODE	DESCRIPTION	LENGTH
59-8807A	Table Mounted	2 x 6 in 51 x 152 mm



Retractors (Abdominal)

Ultra™ Side Loading Retractor

CODE	DESCRIPTION	LENGTH	
59-0101	Longitudinal, Table Mounted, with Double Hinge	14 x 15 in	356 x 381 mm
59-0100	Transverse 4 ³ / ₄ in (120 mm) Rack, Table Mounted, with Double Hinge	2 ³ / ₄ x 2 in	70 x 51 mm



59-0100

Retractors (Bookwalter® Internal Mammary Artery)

Bookwalter® I.M.A. Crossbar

CODE	DESCRIPTION	LENGTH	
50-4601	Table Mounted, Small	12 in	305 mm



Retractors (Bookwalter® Internal Mammary Artery)

Bookwalter® I.M.A. "T" Crossbar

CODE	DESCRIPTION
50-4675	

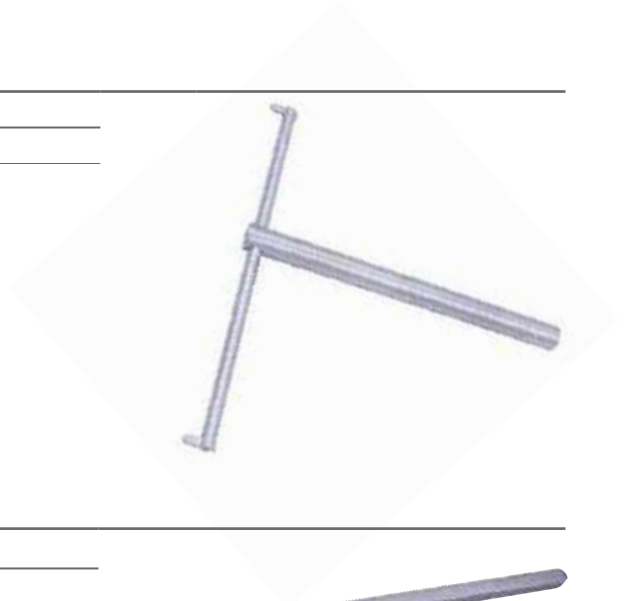

Bookwalter® I.M.A. Retractor Blade

CODE	DESCRIPTION	LENGTH
50-4603		12in 305 mm

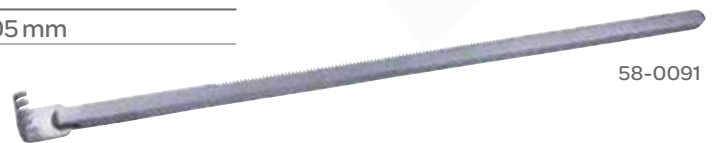

Bookwalter® I.M.A. Retractor Storage Case

CODE	DESCRIPTION	LENGTH
50-4604		



Bookwalter® I.M.A. Ratchet Mechanism

CODE	DESCRIPTION
50-4602	I.M.A. Ratchet Mechanism, Table Mounted



Retractors (Bookwalter®)



50-4580



50-4579



50-4508

Bookwalter® Blades & Accessories Case

CODE	DESCRIPTION	LENGTH	
50-4508	Blades and Accessories Case: Designed to Hold the Following Bookwalter® Components: Sterilization:	3 ¹¹ / ₁₆ x 13 ¹ / ₈ x 22 ¹ / ₈ in 94 x 333 x 562 mm	
50-4579	Case Holds Two-Each Retractor Ratchet Mechanisms		
50-4580	Case Holds Six-Each Tilting Ratchet Mechanisms		
50-4554	Post Coupling	1 x 1 in	25 x 25 mm
50-4566	Harrington Retractor Blades		
50-4571	Kelly Retractor Blades	2 x 6 in	51 x 152 mm
50-4570	Kelly Retractor Blades	2 x 5 in	51 x 127 mm
50-4568	Case Holds Two Each Kelly Retractor Blades	2 x 3 in	51 x 76 mm
50-4569	Kelly Retractor Blades	2 x 4 in	51 x 102 mm
50-4576	Balfour Retractor Blade	2 ⁵ / ₈ x 3 in	67 x 76 mm
50-4577	Retractor Gelpi Blade		
50-4562	Malleable Retractor Blades	1 ¹ / ₂ x 6 in	38 x 152 mm
50-4567	Malleable Retractor Blades	3 x 6 in	76 x 152 mm
50-4561	Case Holds Two Each Malleable Retractors	2 x 6 in	51 x 152 mm

Questions? Contact us at customerservice@symmetrysurgical.com
or learn more at symmetrysurgical.com

Retractors (Bookwalter®)



50-4507

Bookwalter® Table Fix & Ring Case, 12 Inch (305 mm) Post

CODE	DESCRIPTION
50-4507	Bookwalter® Table Fix & Ring Case, Designed to Hold the Following Bookwalter® Components
50-4581	Table Post
50-4582	Horizontal Flex Bar
50-4552	Retractor Horizontal Bar
50-4583	Medium Segmented Ring
50-4557	Retractor, Oval Ring Medium

Retractors (Carotid)

Henly Carotid Retractor

CODE	DESCRIPTION	LENGTH
55-9050	Retractor Modified Weitlaner with Three Center Blades, Blunt Blades	6½ in 165 mm
55-9050B	Retractor Blades Only	
55-9051	Retractor Frame Only	



55-9050

Retractors (Epicardial)

I.M.A. Epicardial Retractor

CODE	DESCRIPTION	LENGTH
80-1864	Mini, Gold Coated Retractor	1 in 25 mm
80-1861	Small, Gold Coated Retractor	1⅛ in 29 mm
80-1862	Medium, Gold Coated Retractor	1½ in 38 mm
80-1863	Large, Gold Coated Retractor,	2⅛ in 54 mm
37-4035	Self-Retaining, Light Spring Steel Parsonnet Epicardial Retractor, 3 x 3 Sharp Prongs	1⅞ in 48 mm



80-1864

Questions? Contact us at customerservice@symmetrysurgical.com
or learn more at symmetrysurgical.com

Retractors (Four Prong)

Murphy Four Prong Retractor

CODE	DESCRIPTION	BLADE WIDTH	BLADE DEPTH	LENGTH
50-8072	Sharp Four Prong Retractors	1 1/16 in 27 mm	5/16 in 8.0 mm	7 3/4 in 197 mm



Retractors (Sternal)

Castaneda Infant Sternal Retractor

CODE	DESCRIPTION	TOTAL OPENING	BLADE WIDTH	ARM LENGTH	LENGTH
50-8060	Castaneda Small	3 in 76 mm	1 7/16 in 37 mm	2 5/8 in 67 mm	3 in 76 mm
50-8061	Castaneda Large	3 1/2 in 89 mm	2 1/2 in 64 mm	3 in 76 mm	3 1/2 in 89 mm



50-8060

Cooley Infant Sternal Retractor

CODE	DESCRIPTION	SPREAD	BLADE LENGTH	ARM LENGTH	BLADE DEPTH
54-1009	Cooley Aluminum Arms and Blades	4 in 102 mm	3 1/8 in 79 mm	3 1/8 in 79 mm	1/2 in 13 mm



Retractors (Lung)

Allison Lung Retractor

CODE	DESCRIPTION	LENGTH
50-8153	Adult, Large	12½ in 318 mm
54-3505	Adult, 40 mm	10¾ in 273 mm

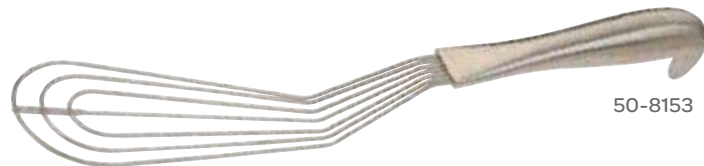

50-8153

Semb Lung Retractor

CODE	BLADE WIDTH	LENGTH
54-3520	¾ in 20 mm	10 in 254 mm
54-3524	½ in 14 mm	10 in 254 mm



54-3524

Zalkind Lung Retractor

CODE	BLADE DEPTH	LENGTH
55-7220.1	2 in 51 mm	12 in 305 mm
55-7230.1	3 in 76 mm	12 in 305 mm



55-7220.1

Retractors (Mini Thoracotomy)

Heitmiller Mini Thoracotomy Retractor

CODE	DESCRIPTION
54-2340	Excellent for Video-Assisted Thoracoscopy



Questions? Contact us at customerservice@symmetrysurgical.com
or learn more at symmetrysurgical.com

Retractors (Multi-Purpose Peripheral Vascular)

Garrett Multi Purpose Peripheral Vascular Retractor

CODE	DESCRIPTION	TOTAL OPENING		BLADE WIDTH		BLADE DEPTH		LENGTH	
50-8015	Self-Retaining, with Three Blades	3½ in	89 mm	1½ in	38 mm	1¼ in	32 mm	7¼ in	184 mm



Retractors (Popliteal)

Darling Popliteal Retractor

CODE	DESCRIPTION	BLADE WIDTH		BLADE DEPTH		LENGTH	
55-8998	Left, Spread 3¾ in (95 mm)	Small, 1¼ in	32 mm	Small, 2⅞ in	54 mm	6½ in	165 mm
		Large, 1½ in	38 mm	Large, 3 in	76 mm		
55-8997	Right, Direction of Widest Blade Upon Placement Determines Whether Left Or Right	Small, 1¼ in	32 mm	Small, 2⅞ in	54 mm	6½ in	165 mm
		Large, 1½ in	38 mm	Large, 3 in	76 mm		



55-8998

Retractors (Rib)

Burford Rib Retractor

CODE	DESCRIPTION	TOTAL OPENING		BLADE (W X D)	ARM LENGTH		LENGTH	
50-8133	Child Model, Self Retaining with Rack and Pinion Action, Aluminum	6 in	152 mm	Large: 1 ⁵ / ₈ x 1 ⁷ / ₈ in 41 x 48 mm Small: 1 ⁵ / ₈ x 1 ³ / ₈ in 41 x 35 mm	6 in	152 mm	6 in	152 mm
50-8033	Self-Retaining, Two Sets of Detachable Blades, Curved Arms	10 in	254 mm	Large: 2 ¹ / ₂ x 2 ⁵ / ₈ in 64 x 67 mm Small: 2 ¹ / ₂ x 1 ³ / ₄ in 64 x 44 mm	9 ¹ / ₂ in	241 mm	10 in	254 mm
50-8031	Self-Retaining, Two Sets of Detachable Blades, Curved Arms	10 in	254 mm	Large: 2 ¹ / ₂ x 2 ⁴ / ₅ in 64 x 71 mm Small: 2 ¹ / ₂ x 1 ³ / ₅ in 64 x 41 mm	9 ³ / ₄ in	248 mm	10 in	254 mm

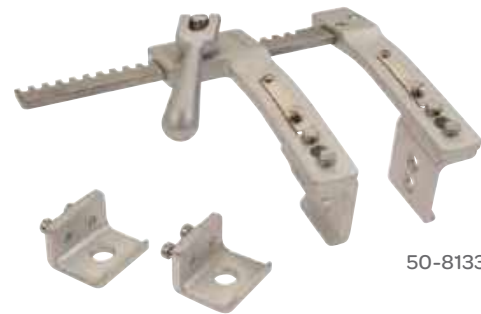

50-8133

Cooley Rib Retractor

Aluminum Arms and Blades

CODE	DESCRIPTION	BLADE LENGTH		BLADE DEPTH		SPREAD		ARM LENGTH	
54-2100	Adult	1 ³ / ₈ in	35 mm	1 ³ / ₈ in	35 mm	7 in	178 mm	4 ¹ / ₄ in	108 mm
54-2101	Pediatric	1 in	25 mm	5/8 in	16 mm	4 ³ / ₄ in	121 mm	3 ⁷ / ₈ in	79 mm



54-2100

Finochietto Rib Retractor

Self-Retaining with Rack and Pinion Action

CODE	DESCRIPTION	TOTAL OPENING		BLADE (W X D)	ARM LENGTH		LENGTH	
50-5625	Infant	2 ¹ / ₂ in	64 mm	3/4 x 1 ³ / ₁₆ in 19 x 30 mm	3 in	76 mm	2 ¹ / ₂ in	64 mm
50-8022		6 ¹ / ₂ in	165 mm	1 ³ / ₄ x 1 ³ / ₄ in 44 x 44 mm	6 in	152 mm	6 in	152 mm



50-5625

Questions? Contact us at customerservice@symmetrysurgical.com
or learn more at symmetrysurgical.com

Retractors (Rib)

Haight-Finochietto Rib Retractor

Self-Retaining with Rack and Pinion Action

CODE	DESCRIPTION	TOTAL OPENING		BLADE (W X D)		ARM LENGTH		LENGTH	
50-8028	Rib Retractor	4 in	102 mm	1¼ x 1⅜ in	32 x 30 mm	3¼ in	83 mm	4 in	102 mm



Tuffier Rib Retractors

CODE	DESCRIPTION	TOTAL OPENING		BLADE (W X D)		ARM LENGTH		LENGTH	
50-8064	Self-Retaining, Serrated Blades	6½ in	165 mm	1¾ x 2 in	44 x 51 mm	3¼ in	83 mm	1¾ in	44 mm



Finochietto Rib Retractor-Contractor, Infant

Self Retaining with Rack and Pinion Action

CODE	BLADE WIDTH		ARM LENGTH		BLADE DEPTH		TOTAL OPENING		LENGTH	
50-8057	⅞ in	22 mm	3¼ in	83 mm	¾ in	19 mm	3½ in	89 mm	3½ in	89 mm



Retractors (Ribbon)

Ribbon Malleable Retractor

CODE	DESCRIPTION	WIDTH		LENGTH	
50-5637	Malleable Retractor	½ in	13 mm	8 in	203 mm
50-5638	Malleable Retractor	⅝ in	16 mm	8 in	203 mm
50-5639	Malleable Retractor	¾ in	19 mm	8 in	203 mm
50-4210	Malleable Retractor	1 in	25 mm	13 in	330 mm
50-4212	Malleable Retractor	1½ in	38 mm	13 in	330 mm
50-4214	Malleable Retractor	2 in	51 mm	13 in	330 mm



50-4210

Ribbon Retractor

Malleable

CODE	DESCRIPTION	WIDTH		LENGTH	
22-0006	Malleable, Stainless Steel	¼ in	6.0 mm	8 in	203 mm
22-0012	Malleable, Stainless Steel	½ in	13 mm	8 in	203 mm
22-0017	Malleable, Stainless Steel	⅝ in	16 mm	8 in	204 mm
22-0027	Malleable, Stainless Steel	1 in	25 mm	10 in	254 mm
22-0252	Malleable, Stainless Steel	1 in	25 mm	13 in	330 mm
22-0253	Malleable, Stainless Steel	1¼ in	32 mm	13 in	330 mm
22-0254	Malleable, Stainless Steel	1½ in	38 mm	13 in	330 mm
22-0255	Malleable, Stainless Steel	2 in	51 mm	13 in	330 mm
22-0256	Malleable, Stainless Steel	2½ in	64 mm	13 in	330 mm
22-0257	Malleable, Stainless Steel	3 in	76 mm	13 in	330 mm
22-0258	Malleable, Stainless Steel	4 in	102 mm	13 in	330 mm
22-0259	Malleable, Stainless Steel	5 in	127 mm	13 in	330 mm



22-0006

Questions? Contact us at customerservice@symmetrysurgical.com
or learn more at symmetrysurgical.com

Retractors (Scapular)

Davidson Scapular Retractor

CODE	DESCRIPTION	HANDLE LENGTH	BLADE WIDTH	BLADE DEPTH	LENGTH
54-3550	Small		2 in 51 mm	3 in 76 mm	
50-8096		6 in 152 mm	3 ½ in 89 mm	3 in 76 mm	6 in 152 mm

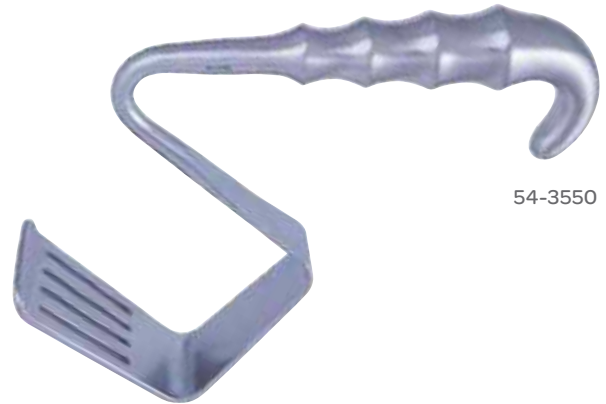

54-3550

Retractors (Self-Retaining)

Balfour Retractor

CODE	DESCRIPTION	LATERAL BLADE WIDTH	LENGTH
50-4503	Fenestrated Blades		1 ¾ in 44 mm
50-4510	Fenestrated Blades	2 ½ in 64 mm	1 ½ in 38 mm
50-4509	Fenestrated Blades	10 ½ in 267 mm	1 ¾ in 44 mm
50-4500	Fenestrated Blades	Self-Retaining with Fixed Lateral Fenestrated Blades and One Center Blade	
50-4514	Two Blades		7 in 178 mm



50-4503

Retractors (Self-Retaining)

Henly Self-Retaining Carotid Retractor

CODE	DESCRIPTION	LENGTH
55-8999	Complete Set, with Three Removable Side Blades and Three Removable Center Blades	
55-8999-1	Side Blade Only	1 x $\frac{7}{8}$ in 25 x 22 mm
55-8999-2	Side Blade Only	2 x $\frac{7}{8}$ in 51 x 22 mm
55-8999-3	Side Blade Only	3 x $\frac{7}{8}$ in 76 x 22 mm
55-8999-4	Center Blade Only	$\frac{3}{4}$ x $\frac{5}{8}$ in 19 x 16 mm
55-8999-5	Center Blade Only	1 x $\frac{5}{8}$ in 25 x 16 mm
55-8999-6	Center Blade Only	1 $\frac{1}{2}$ x $\frac{5}{8}$ in 38 x 16 mm
55-8999-7	Center Blade Only	$\frac{5}{8}$ x 3 in 16 x 76 mm
55-8999-8	Center Blade Only	$\frac{5}{8}$ x 2 in 16 x 51 mm



55-8999

Microvascular Modified Alm Retractor

CODE	DESCRIPTION	PRONGS	LENGTH
80-1812	Black Anodized	4 x 4 Prongs	3 in 76 mm
80-1813	Black Anodized	12 x 12 Prongs	3 $\frac{3}{4}$ in 95 mm



80-1813

Retractors (Self-Retaining)

Pediatric Balfour Retractor

CODE	DESCRIPTION	LATERAL BLADE WIDTH
50-5651	Pediatric Balfour Retractor	1 in 25 mm



Weitlaner Retractor

CODE	PRONGS	PRONGS	TOTAL OPENING	LENGTH
50-5647	Self-Retaining Prongs	2 x 3 Prongs, Blunt	2 ¼ in 57 mm	2 ¼ x 4 ½ in 57 x 114 mm
50-5646	Self-Retaining Prongs	2 x 3 Prongs, Sharp	4 ½ in 114 mm	2 ¼ x 4 ½ in 57 x 114 mm
50-1195	Self-Retaining Prongs	3 x 4 Prongs, Blunt	2 ¼ in 57 mm	5 ½ in 140 mm
50-1197	Self-Retaining Prongs	3 x 4 Prongs, Blunt	4 in 102 mm	6 ½ in 165 mm
50-1199	Self-Retaining Prongs	3 x 4 Prongs, Blunt	5 in 127 mm	7 ½ in 191 mm
50-1201	Self-Retaining Prongs	3 x 4 Prongs, Blunt	5 ¾ in 146 mm	9 in 229 mm
50-1194	Self-Retaining Prongs	3 x 4 Prongs, Sharp	2 ¼ in 57 mm	5 ½ in 140 mm
50-1196	Self-Retaining Prongs	3 x 4 Prongs, Sharp	4 in 102 mm	6 ½ in 165 mm
50-1198	Self-Retaining Prongs	3 x 4 Prongs, Sharp	5 in 127 mm	7 ½ in 191 mm
50-1200	Self-Retaining Prongs	3 x 4 Prongs, Sharp	5 ¾ in 146 mm	9 in 229 mm



50-1194

Retractors (Splanchnic)

Harrington Splanchnic Retractor

CODE	DESCRIPTION	LENGTH
50-8100	Harrington Splanchnic Retractor	12½ x 1½ in 318 x 38 mm
50-8102	Harrington Splanchnic Retractor	12½ x 1½ in 318 x 38 mm



50-8102

Retractors (Sternal)

Ankeney Sternal Retractor

CODE	PRONGS	TOTAL OPENING	BLADE (W X D)	ARM LENGTH	SPRING LENGTH	LENGTH
50-8068	Child, Aluminum, with Stainless Steel Rack	5 in 127 mm	¾ x 1 in 19 x 25 mm	4 ½ in 114 mm		5 in 127 mm
50-8069	Adult, Self-Retaining with Rack and Pinion Action	7 in 178 mm	1 ¾ x 1 ¼ in 35 x 32 mm	11 ½ in 292 mm	3 ¼ in 83 mm	11 ½ in 292 mm



50-8069

Questions? Contact us at customerservice@symmetrysurgical.com
or learn more at symmetrysurgical.com

Retractors (Sternal)

Ankeney Sternal Retractor Blades

for use with 50-8069 and 50-8068

CODE	QTY	BLADE WIDTH		BLADE DEPTH		LENGTH	
50-8070	Set of Six	1 3/8 in	35 mm	2 in	51 mm	8 in	203 mm



Collins Sternal Retractor

CODE	DESCRIPTION	TOTAL OPENING		ARM LENGTH		LENGTH	
50-8080	Self-Retaining w/Rack and Pinion Action, Body Only	8 in	203 mm	8 3/4 in	222 mm	8 1/8 in	206 mm



Cooley Sternal Retractor

CODE	DESCRIPTION	BLADE LENGTH		BLADE DEPTH		SPREAD	
54-1003	Adult Sternal Retractor	2 in	51 mm	1 3/8 in	35 mm	9 1/2 in	241 mm



Retractors (Sternal)

Favaloro-Morse Sternal Retractor

With Two Pair of Fixed Sternal Blades

CODE	TOTAL OPENING	BLADE WIDTH	BLADE DEPTH	ARM LENGTH	LENGTH
50-8090	8 in 203 mm	1½ in 29 mm	1½ in 38 mm	7⅝ in 186 mm	8 in 203 mm



Himmelstein Sternal Retractor

Self-Retaining with Ratchet Action and Flexible Arms

CODE	TOTAL OPENING	BLADE WIDTH	BLADE DEPTH	ARM LENGTH	LENGTH
50-1133	5 in 127 mm	1⅜ in 35 mm	1¼ in 32 mm	5¼ in 133 mm	5 in 127 mm



Morse Sternal Retractor

Adult and Child Self-Retaining with Rack and Pinion Action

CODE	TOTAL OPENING	BLADE WIDTH	BLADE DEPTH	ARM LENGTH	LENGTH
50-8067	8 in 203 mm	1½ in 29 mm	1 in 25 mm	7½ in 191 mm	8 in 203 mm
50-8066	6¼ in 159 mm	¾ in 19 mm	¾ in 19 mm	6 in 152 mm	6¼ in 159 mm



50-8066

Questions? Contact us at customerservice@symmetrysurgical.com
or learn more at symmetrysurgical.com

Retractors (Sternal)

Pacifico Sternal Retractor

Self-Retaining

CODE	TOTAL OPENING	UPPER & LOWER BLADE WIDTH	LOWER BLADE DEPTH	ARM LENGTH	LENGTH
50-8085	8 in 203 mm	¾ in 19 mm	1½ in 38 mm	6 in 152 mm	8 in 203 mm



Retractors (Tissue)

Tissue Retractors

CODE	PRONGS	TOTAL OPENING	PRONG WIDTH	PRONG DEPTH	LENGTH
501223	3 x 3 Prongs, Blunt	2½ in 64 mm	½ in 13 mm	⅝ in 16 mm	5¼ in 133 mm



Retractors (Vascular)

Ochsner Vascular Retractor

With Swiveling Blades, Self-Retaining and Flexible Arms

CODE	TOTAL OPENING	BLADE WIDTH	BLADE DEPTH	ARM LENGTH	LENGTH
50-8016	5½ in 140 mm	1 in 25 mm	2 in 51 mm	¾ in 83 mm	8 in 203 mm



Retractors (Vascular Spring)

Vascular Spring Retractor

CODE	DESCRIPTION
55-9075	Small
55-9074	Large



55-9075

Retractors (Vein Holder)

Huang Vein Holder

CODE	DESCRIPTION	TIP WIDTH	MAXIMUM DIAMETER	LENGTH
21-8011	Tapering Tip	1.0 mm	$\frac{3}{8}$ in 10 mm	7 in 178 mm



Boley Retractor

CODE	DESCRIPTION	BLADE WIDTH
50-5608	No 1, Double-Ended	$6\frac{1}{4}$ in 159 mm



Children's Hospital Retractor

CODE	DESCRIPTION	BLADE WIDTH
50-4100	Small, Double-Ended	$\frac{7}{16}$ in 11 mm
50-5645	S-Shaped, Double-Ended	$\frac{1}{4}$ in 6.0 mm



50-4100

Retractors (Vein Holder)

Crile Retractor

CODE	DESCRIPTION	BLADE WIDTH	
50-4105	Double-Ended	¼ in	6.0 mm



Cushing Retractor

CODE	JAW LENGTH	LENGTH	
32-3633	10 mm	11 in	279 mm
32-3634	11 mm	14 in	356 mm



32-3633

Deaver Retractor

CODE	DESCRIPTION	HANDLE	LENGTH	
50-4303	No 1	Standard Handle	12 x 1 in	305 x 25 mm
50-4304	No 2	Standard Handle	13 x 1 in	330 x 25 mm
50-4306	No 3	Standard Handle	12 x 1½ in	305 x 38 mm
50-4307	No 4	Standard Handle	12 x 2 in	305 x 51 mm
50-4308	No 5	Standard Handle	12 x 3 in	305 x 76 mm
50-4316	No 1	Ring Grip Handle	1 in	25 mm
50-4317	No 2	Ring Grip Handle	1 in	25 mm
50-4319	No 3	Ring Grip Handle	1½ in	38 mm
50-4320	No 4	Ring Grip Handle	2 in	51 mm
50-4321	No 5	Ring Grip Handle	3 in	76 mm



50-4307

Retractors (Vein Holder)

Deaver Obese Retractor

CODE	DESCRIPTION	BLADE LENGTH	LENGTH
32-3635	Self-Retaining with Ratchet Action and Flexible Arms	2 ½ in 64 mm	14 ½ in 368 mm

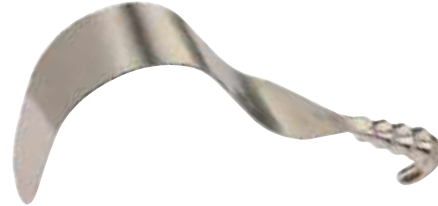

Deaver Pediatric Retractor

CODE	DESCRIPTION	BLADE SIZE
50-5631	Standard Handle	8 x 2 ½ x 1 in 203 x 64 x 25 mm
50-5629	Standard Handle	8 x 2 ½ x 1 in 203 x 64 x 25 mm
50-5630	Standard Handle	8 x 2 ½ x 1 in 203 x 64 x 25 mm



50-5631

Goelet Retractor

CODE	DESCRIPTION	BLADE WIDTH
50-4095	Double-Ended	1 ¼ in 32 mm



Henley Retractor Set

CODE	DESCRIPTION
32-3652	Complete Set, 3 Pair Side Blades, 4 Center Blades



32-3652

Questions? Contact us at customerservice@symmetrysurgical.com
or learn more at symmetrysurgical.com

Retractors (Vein Holder)

Kelly Retractor

CODE	DESCRIPTION	HANDLE	BLADE WIDTH	
50-4110	Small	Standard Handle	1½ in	38 mm
50-4111	Medium	Standard Handle	2 in	51 mm
50-4112	Large	Standard Handle	2½ in	64 mm
50-4115	Small	Ring Grip Handle	1½ in	38 mm
50-4116	Medium	Ring Grip Handle	2 in	51 mm
50-4117	Large	Ring Handle	2½ in	64 mm
50-4118	Extra Large	Ring Handle	3 in	76 mm



50-4110

Mathieu Retractor

CODE	DESCRIPTION	PRONG WIDTH	
50-4291	Double-Ended, Three Prong Blade, Blunt	¾ in	10 mm
50-4290	Double-Ended, Three Prong Blade, Sharp	¾ in	10 mm



50-4291

Ollier Retractor

CODE	DESCRIPTION	BLADE WIDTH	
50-4253	Four-Prong, Blunt	2¼ in	57 mm



Retractors (Vein Holder)

Parker Retractors

CODE	DESCRIPTION	HANDLE	BLADE WIDTH	
22-1418	Set of 2	Standard Handle	7 in	178 mm
50-4090	Small	Ring Grip Handle	$\frac{5}{8}$ in	16 mm
50-4091	Long	Standard Handle	1 in	25 mm



50-4091

Richardson-Eastman Retractor

CODE	DESCRIPTION	BLADE WIDTH	
50-4135C	Small, Double-Ended, Set of Two	10 in	254 mm



50-4135C

Richardson Retractor

CODE	DESCRIPTION	SIZE	BLADE WIDTH		LENGTH	
50-4120	Standard Handle	Small	$\frac{3}{4}$ in	19 mm	$9\frac{1}{4}$ in	235 mm
50-4121	Standard Handle	Medium	1 in	25 mm	$9\frac{1}{4}$ in	235 mm
50-4122	Standard Handle	Large	$1\frac{1}{2}$ in	38 mm	$9\frac{1}{2}$ in	241 mm
50-4123C	Ring-Grip Handle	Small	$\frac{3}{4}$ in	19 mm	$9\frac{1}{2}$ in	241 mm
50-4124C	Ring-Grip Handle	Medium	1 in	25 mm	$9\frac{1}{2}$ in	241 mm
50-4125C	Ring-Grip Handle	Large	$1\frac{1}{2}$ in	38 mm	$9\frac{1}{2}$ in	241 mm

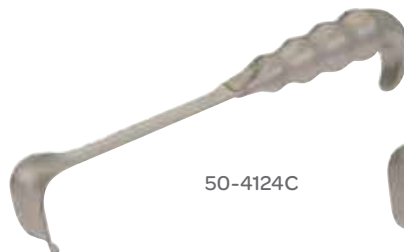

50-4124C



50-4122

Questions? Contact us at customerservice@symmetrysurgical.com
or learn more at symmetrysurgical.com

Retractors (Vein Holder)

Senn Retractor

CODE	DESCRIPTION	PRONG WIDTH	LENGTH
20-0509	Blunt, Double-Ended, Three Prong		6¼ in 159 mm
20-0508	Sharp, Double-Ended, Three Prong		6¼ in 159 mm
50-4261	Blunt, Double-Ended, Three Prong	5/16 in 8.0 mm	67/8 in 175 mm
50-4260	Sharp, Double-Ended, Three Prong	5/16 in 8.0 mm	67/8 in 175 mm

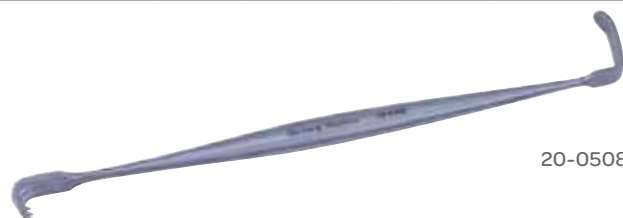

20-0508

US Army Retractors

CODE	DESCRIPTION	WIDTH	SIZE
50-4071	Set of 2, Double-Ended	8 5/16 in 211 mm	1 3/4 in x 9/16 in 44 x 14 mm



Volkman Retractor

CODE	DESCRIPTION	PRONGS	BLADE LENGTH	BLADE WIDTH
50-4225CO	2-Prong Blunt	3 x 4 Prongs, Blunt	8 3/4 in 222 mm	7/16 in 11 mm
50-4220CO	2-Prong Sharp	3 x 4 Prongs, Blunt	8 3/4 in 222 mm	7/16 in 11 mm
50-4226CO	3-Prong Blunt	3 x 4 Prongs, Blunt	8 3/4 in 222 mm	1 1/16 in 27 mm
50-4221CO	3-Prong Sharp	3 x 4 Prongs, Blunt	8 3/4 in 222 mm	1 1/16 in 27 mm
504227CO	4-Prong Blunt	3 x 4 Prongs, Sharp	8 3/4 in 222 mm	1 5/16 in 33 mm
504222CO	4-Prong Sharp	3 x 4 Prongs, Sharp	8 3/4 in 222 mm	1 5/16 in 33 mm
50-4228CO	6-Prong Blunt	3 x 4 Prongs, Sharp	8 3/4 in 222 mm	1 1/2 in 38 mm
50-4223CO	6-Prong Sharp	3 x 4 Prongs, Sharp	8 3/4 in 222 mm	1 1/2 in 38 mm



50-4225CO

Retractors (Vision)

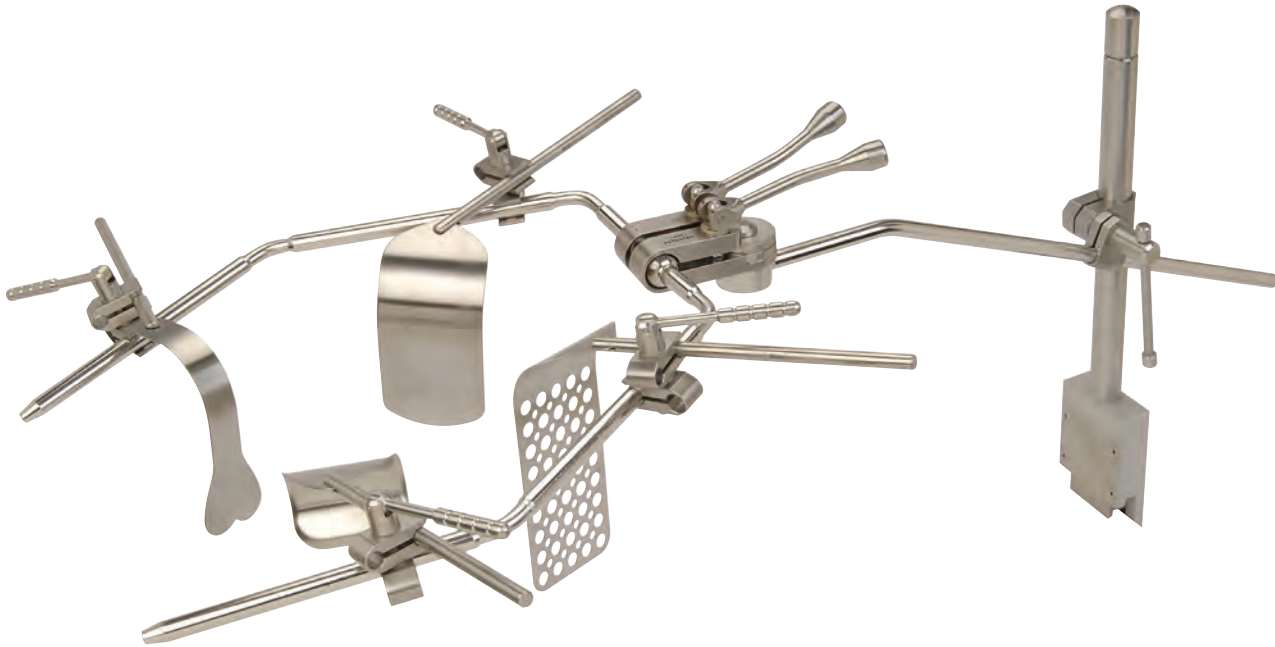

Vision Retractor System

CODE	DESCRIPTION	DIMENSIONS		QTY
59-8850	Vision General System, Include The Following Items:			
59-8802	Table Clamp with Vertical Post			1
59-8803	Retractor Clamp			6
59-8805	Vision Frame			1
59-8807	Mayo Swivel	2 3/4 x 2 in	70 x 51 mm	2
59-8809	Deaver Swivel	2 3/4 x 4 1/2 in	70 x 114 mm	1
59-8811	Harrington "Sweetheart"	2 x 5 in	50 x 127 mm	1
59-8813	Kelly Swivel "Modified"	3 x 2 1/2 in	76 x 64 mm	1
59-8814	Kelly Swivel "Modified"	3 x 4 in	76 x 102 mm	1
59-8815	Malleable Swivel, Perforated	3 x 6 in	76 x 152 mm	1
59-8816	Malleable Swivel, Perforated	3 x 6 1/2 in	76 x 165 mm	1
59-8818	Fence Swivel, Perforated	4 x 6 in	102 x 152 mm	1
59-8821	Splanchnic Swivel	2 x 6 in	51 x 152 mm	1
59-8828	Sterilization Case			1

Note: Individual components are available, in single quantities, by referencing their unique product code upon ordering.

Retractors (Vision)

Vision Retractor System

CODE	DESCRIPTION	DIMENSIONS		QTY
59-8855	Vision General Expanded System Include The Following Items:			
59-8802	Table Clamp with Vertical Post			1
59-8803	Retractor Clamp			8
59-8804	Extension Arm, Hinged			1
59-8805	Vision Frame			1
59-8807	Mayo Swivel	2 ¾ x 2 in	70 x 51 mm	2
59-8809	Deaver Swivel	2 ¾ x 4 ½ in	70 x 114 mm	1
59-8811	Harrington "Sweetheart"	2 x 5 in	51 x 127 mm	1
59-8813	Kelly Swivel "Modified"	3 x 2 ½ in	76 x 64 mm	1
59-8814	Kelly Swivel "Modified"	3 x 4 in	76 x 102 mm	1
59-8815	Malleable Swivel, Perforated	3 x 6 in	76 x 152 mm	1
59-8816	Malleable Swivel, Perforated	3 x 6 ½ in	76 x 165 mm	1
59-8818	Fence Swivel, Perforated	4 x 6 in	102 x 152 mm	1
59-8821	Splanchnic Swivel	2 x 6 in	51 x 152 mm	1
59-8828	Sterilization Case			1

Note: Individual components are available, in single quantities, by referencing their unique product code upon ordering.

Complete Vision Vascular System

CODE	DESCRIPTION	DIMENSIONS		QTY
59-8860	Complete Vision Vascular System, Include The Following Items:			
59-8802	Table Clamp w/ Vertical Post			1
59-8803	Retractor Clamp			8
59-8805	Vision Frame			1
59-8807	Mayo Swivel	2 ¾ x 2 in	70 x 51 mm	2
59-8808	Mayo Swivel	3 ½ x 2 in	89 x 51 mm	1
59-8809	Deaver Swivel	2 ¾ x 4 ½ in	70 x 114 mm	1
59-8811	Harrington "Sweetheart"	2 x 5 in	51 x 127 mm	1
59-8815	Malleable Swivel, Perforated	3 x 6 in	76 x 152 mm	1
59-8816	Malleable Swivel, Perforated	3 x 6 ½ in	76 x 165 mm	1
59-8818	Fence Swivel, Perforated	4 x 6 in	102 x 152 mm	1
59-8820	Splanchnic Swivel	2 x 6 in	51 x 152 mm	1
59-8821	Splanchnic Swivel	2 x 6 in	51 x 152 mm	1
59-8824	Renal Swivel			2
59-8828	Sterilization Case			1

Note: Individual components are available, in single quantities, by referencing their unique product code upon ordering.

Retractors (Vision)

Complete Expanded Vision Vascular System

CODE	DESCRIPTION	DIMENSIONS		QTY
59-8865	Vision Vascular Expanded System, Includes The Following Items			
59-8802	Table Clamp w/ Vertical Post			1
59-8803	Retractor Clamp			10
59-8804	Extension Arm, Hinged			1
59-8805	Vision Frame			1
59-8807	Mayo Swivel	2 ¾ x 2 in	70 x 51 mm	2
59-8808	Mayo Swivel	3 ½ x 2 in	89 x 51 mm	1
59-8809	Deaver Swivel	2 ¾ x 4 ½ in	70 x 114 mm	1
59-8811	Harrington "Sweetheart"	2 x 5 in	51 x 127 mm	1
59-8815	Malleable Swivel, Perforated	3 x 6 in	76 x 152 mm	1
59-8816	Malleable Swivel, Perforated	3 x 6 ½ in	76 x 165 mm	1
59-8818	Fence Swivel, Perforated	4 x 6 in	102 x 152 mm	1
59-8820	Splanchnic Swivel	2 x 6 in	51 x 152 mm	1
59-8821	Splanchnic Swivel	2 x 6 in	51 x 152 mm	1
59-8824	Renal Swivel			2
59-8828	Sterilization Case			1

Note: Individual components are available, in single quantities, by referencing their unique product code upon ordering.

Rib Spreaders

Neonatal Rib Spreader

CODE	DESCRIPTION	BLADE (W X L)		SPREAD	ARM LENGTH
54-1000	Neonatal Rib Spreader	¼ x ¼ in	6.0 x 6.0 mm	1 ⅝ in 41mm	1 in 25mm



Questions? Contact us at customerservice@symmetrysurgical.com
or learn more at symmetrysurgical.com

Rongeurs (Aortic)

Bailey Aortic Rongeur

CODE	DESCRIPTION	BITE	LENGTH
55-8011	Straight	3.0 mm	4¼in 108 mm



Rongeurs (Bone Cutting Forceps)

Liston Bone Cutting Rongeur

CODE	DESCRIPTION	LENGTH
30-1310	Straight	5½in 140 mm

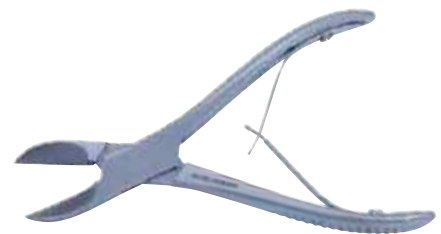

Ruskin Bone Rongeur

Double Action

CODE	DESCRIPTION	JAWS WIDTH	LENGTH
31-0605	Straight	5.0 mm	7⅛in 181 mm
31-0625	Straight	5.0 mm	9½in 241 mm
31-0705	Curved	5.0 mm	7⅛in 181 mm
31-0725	Curved	5.0 mm	9½in 241 mm



31-0705

Stille-Luer Rongeur

CODE	DESCRIPTION	JAWS	LENGTH
31-3027	Straight, Double Action	17 mm	10½in 267 mm
31-3023	Straight, Double Action	10 mm	9in 229 mm
53-1133	Angular	5.0 mm Bite	9½in 241 mm
53-1118	Angular, Flat Lower Jaw	5.0 mm Bite	9½in 241 mm
31-3123	Curved, Double Action	10 mm	9in 229 mm



31-3123

Rongeurs (First Rib Rongeur)

Stille Duckbill Bone Rongeur

CODE	DESCRIPTION	JAWS WIDTH	LENGTH
31-3183	Double Action, Angled to Side	7.0 mm	9 in 229 mm



Rongeurs (Duckbill Bone Rongeur)

Dale First Rib Rongeur

CODE	DESCRIPTION	BITE	LENGTH
56-8040	Double Action	1/8 in 3.0 mm	14 1/2 in 368 mm



Saws

Sternum Saw

CODE	DESCRIPTION	
26-7006	Sternum Saw	Air Powered, Handpiece w/Footplate
26-7010	Sternum Saw Blades	Sterile Disposable, 5 Per Package
26-7004	Sternum Saw Footplate	
26-7005	Sternum Saw Set	Includes (Below) Air Powered
26-7003	Sternum Saw Set Sterilizing Case	



26-7010



26-7006

Scissors (Artery)

Church Artery Scissors

CODE	DESCRIPTION	LENGTH
04-7527	Curved	7 in 178 mm
04-7427	Straight	7 in 178 mm



04-7527

Scissors (Bandage)

Classic® Lister Bandage Scissors

CODE	DESCRIPTION	LENGTH
34-4013	Straight	7½ in 191 mm



Lister Bandage Scissors

CODE	DESCRIPTION	BLADE SIZE
54-4012	Equal sized rings	5¾ in 146 mm
54-4013	Equal sized rings	7½ in 191 mm
54-4192	One Large Ring	7¼ in 184 mm



Scissors (Calcified Tissue)

Calcified Tissue Scissors

CODE	DESCRIPTION	BLADE SIZE
54-8024	Curved, Serrated Blades	9 in 229 mm



Scissors (Cardiovascular)

Cooley Cardiovascular Scissors “My Scissors”

CODE	DESCRIPTION	HANDLES	BLADE SIZE
55-1350	Curved on Flat		7½ in 191 mm
55-1350L	Curved on Flat	Left Handed	7½ in 191 mm
37-4036	Curved on Flat	Mayo Type Handles	7½ in 191 mm
55-1351	Curved on Flat		9 in 229 mm



Scissors (Circumflex)

Beall Circumflex Scissors

CODE	DESCRIPTION	LENGTH
55-1108	Circumflex Scissors	6 in 152 mm



Scissors (Coronary)

Favaloro Coronary Scissors

CODE	DESCRIPTION	ANGLE	BLADE (W X L)	LENGTH
54-8010	Curved Shank	130°	1/8 x 7/16 in 3.0 x 11 mm	6 3/4 in 171 mm
55-8085		130°	1/8 x 7/16 in 3.0 x 11 mm	6 3/4 in 171 mm

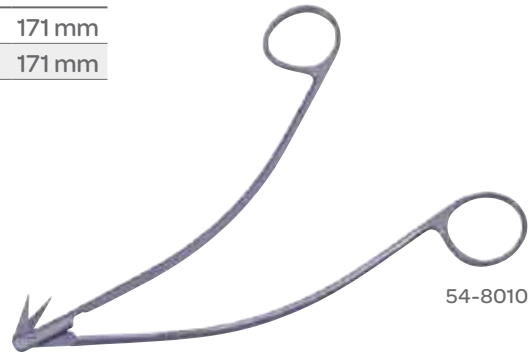

Scissors (Coronary Artery)

Diethrich Coronary Artery Scissors

CODE	ANGLE	LENGTH
54-8017	Angled 25°	7 in 178 mm
55-1001	Angled 25°	7 in 178 mm
54-8018	Angled 45°	7 in 178 mm
54-8019	Angled 60°	7 in 178 mm
54-8021	Angled 90°	7 in 178 mm
54-8020	Angled 125°, With Stabilizing Bar	7 in 178 mm
55-1002	Angled 45°	7 1/4 in 184 mm
55-1026	Angled 25°	8 1/2 in 216 mm
55-1027	Angled 45°	8 1/2 in 216 mm
55-1028	Angled 60°	8 1/2 in 216 mm
55-1029	Angled 90°	8 1/2 in 215 mm

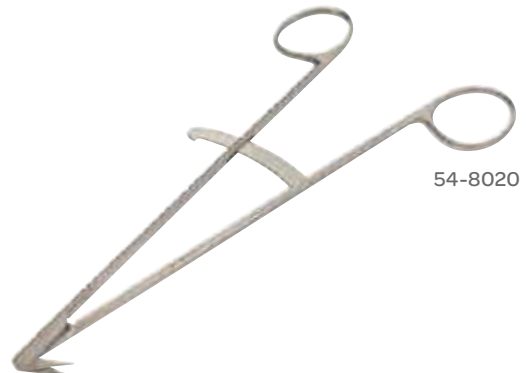

Scissors (Coronary Artery)

Coronary Artery Scissors

CODE	DESCRIPTION	LENGTH	
54-8070	Angled 25°	7 in	178 mm
55-8071	Angled 45°	7 in	178 mm
55-8072	Angled 60°	7 in	178 mm
54-8073	Angled 90°	7 in	178 mm
54-8074	Angled 105°	7 in	178 mm
54-8075	Angled 125°, with Stabilizer Bar	7 in	178 mm

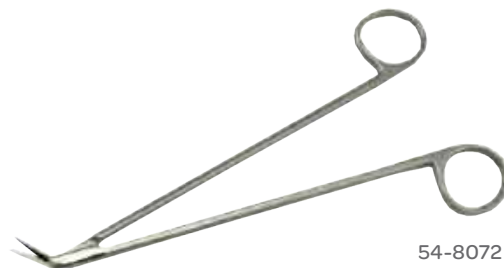

54-8072

Coronary Artery Scissors

Ball Tip

CODE	DESCRIPTION	LENGTH	
55-8501	Angled 25°	6 3/4 in	171 mm
55-8502	Angled 45°	6 3/4 in	171 mm
55-8503	Angled 60°	6 3/4 in	171 mm
55-8504	Angled 90°	6 3/4 in	171 mm
55-8505	Angled 120°	6 3/4 in	171 mm



55-8501

Coronary Artery Scissors

Flat Handle

CODE	DESCRIPTION	LENGTH	
55-8601	Angled 25°	6 3/4 in	171 mm
55-8602	Angled 45°	6 3/4 in	171 mm
55-8603	Angled 60°	6 3/4 in	171 mm
55-8604	Angled 90°	6 3/4 in	171 mm
55-8605	Angled 120°	6 3/4 in	171 mm



55-8601

Reul Coronary Artery Scissors

CODE	ANGLE	BLADE (W X L)	LENGTH
54-8011	45°	1/4 x 1 3/16 in 6.0 x 30 mm	7 1/4 in 184 mm
54-8014	60°	1/8 x 7/8 in 3.0 x 22 mm	7 1/4 in 184 mm



54-8014

Scissors (Delicate)

Delicate Scissors

CODE	DESCRIPTION	LENGTH
54-2515	Blunt, Straight	4 ½ in 114 mm
54-2520	Blunt/Blunt, Curved	4 ½ in 114 mm
54-5567	Curved with Dissecting End	4 7/8 in 124 mm



54-2515

Scissors (Dissecting)

Classic® Mayo Scissors

CODE	DESCRIPTION	LENGTH
34-4098	Straight, Beveled Blades	5 ½ in 140 mm
34-4490	Straight, Beveled Blades	6 ¾ in 171 mm
34-4092	Straight, Rounded Blades	6 ¾ in 171 mm
34-4088	Straight, Rounded Blades	5 ½ in 140 mm
34-4095	Curved, Beveled Blades	6 ¾ in 171 mm
34-4097	Curved, Round Blades	6 ¾ in 171 mm



34-4095

Classic® Metzenbaum Scissors

CODE	DESCRIPTION	LENGTH
34-1020	Blunt/Blunt, Straight	5 ¾ in 146 mm
34-1021	Blunt/Blunt, Curved	5 ¾ in 146 mm
34-1027	Blunt/Blunt, Curved	7 in 178 mm



34-1027

Scissors (Dissecting)

DeBakey-Metzenbaum Scissors

Tungsten Carbide Edges

CODE	DESCRIPTION	LENGTH
32-3576	Straight	12¼ in 311 mm



Delicate Dissecting Scissors

CODE	DESCRIPTION	LENGTH
54-5566	Curved	5 in 127 mm



Delicate Lahey Scissors

CODE	DESCRIPTION	LENGTH
54-5571	Curved	5¾ in 146 mm



Delicate Metzenbaum Scissors

CODE	DESCRIPTION	LENGTH
54-5573	Curved	7 in 178 mm



Doyen Abdominal Scissors

CODE	DESCRIPTION	LENGTH
54-4080	Straight	7 in 178 mm



Scissors (Dissecting)

Fergusson Abdominal Scissors

CODE	DESCRIPTION	LENGTH
54-4085	Angled on Flat	7¼ in 184 mm



Jacobson Scissors

CODE	DESCRIPTION	LENGTH
55-8088	Angled, Sharp	6¾ in 171 mm



Jorgenson Dissecting Scissor

CODE	DESCRIPTION	LENGTH
54-4151	Strong Curve	8½ in 216 mm
54-4023	Strong Curve	9 in 229 mm
54-4080S	Strong Curve	14 in 356 mm



54-4151

Lincoln Scissors

Rounded Blades

CODE	DESCRIPTION	LENGTH
55-2270	Straight	7 in 178 mm
55-2280	Curved	7 in 178 mm



55-2280

Questions? Contact us at customerservice@symmetrysurgical.com
or learn more at symmetrysurgical.com

Scissors (Dissecting)

Mayo Dissecting Scissors

CODE	DESCRIPTION	LENGTH	
54-4098	Straight, Beveled Blades	5½ in	140 mm
54-4090	Straight, Beveled Blades	6¾ in	171 mm
54-5535	Straight, Beveled Blades	9 in	229 mm
54-4088	Straight, Round Blades	5¾ in	146 mm
54-4099	Curved, Beveled Blades	5½ in	140 mm
54-4095	Curved, Beveled Blades	6¾ in	171 mm
54-4105	Curved, Beveled Blades	9 in	229 mm
54-4097	Curved, Round Blades	6¾ in	171 mm



54-4090

Mayo Dissecting Scissors

Dissecting Scissors, Stellite Edge Inserts

CODE	DESCRIPTION	LENGTH	
54-4092	Straight, Round Blades	6¾ in	171 mm
36-5060	Curved	5½ in	140 mm
36-5061	Curved	6¾ in	171 mm
36-5062	Curved	9 in	229 mm



54-4092

Mayo Scissors

Dissecting Scissors, Stellite Edge Inserts

CODE	DESCRIPTION	LENGTH	
36-5050	Straight	5½ in	140 mm
36-5051	Straight	6¾ in	171 mm
36-5052	Straight	9 in	229 mm



36-5050

Mayo-Harrington Dissecting Scissors

CODE	DESCRIPTION	LENGTH	
32-3592	Straight	14 in	356 mm
03-5323	Curved, Slender Pattern	9 in	229 mm
32-3593	Curved	14 in	356 mm
32-3585	Curved	14 in	356 mm



32-3592

Scissors (Dissecting)

Mayo-Noble Scissors

Dissecting Scissors, Beveled Blades

CODE	DESCRIPTION	LENGTH
54-4075	Straight	6 ¼ in 159 mm
54-4076	Curved	6 ¼ in 159 mm



54-4076

Metzenbaum Classic Plus® Dissecting Scissors

Straight, Delicate Stellite Edge Inserts

CODE	DESCRIPTION	LENGTH
36-5021	Blunt/Blunt	5 ¾ in 146 mm
36-5023	Blunt/Blunt	7 in 178 mm
36-5025	Blunt/Blunt	9 in 229 mm
36-5020	Sharp/Sharp	5 ¾ in 146 mm
36-5022	Sharp/Sharp	7 in 178 mm
36-5024	Sharp/Sharp	9 in 229 mm



36-5020

Metzenbaum Classic Plus® Dissecting Scissors

Curved, Delicate Stellite Edge Inserts

CODE	DESCRIPTION	LENGTH
36-5031	Blunt/Blunt	5 ¾ in 146 mm
36-5033	Blunt/Blunt	7 in 178 mm
36-5035	Blunt/Blunt	9 in 229 mm
36-5030	Sharp/Sharp	5 ¾ in 146 mm
36-5032	Sharp/Sharp	7 in 178 mm
36-5034	Sharp/Sharp	9 in 229 mm



36-5031

Metzenbaum Classic Plus® Dissecting Scissors

Standard, Stellite Edge Inserts

CODE	DESCRIPTION	LENGTH
36-5010	Straight	5 ¾ in 146 mm
36-5011	Straight	7 in 178 mm
36-5015	Curved	5 ¾ in 146 mm
36-5016	Curved	7 in 178 mm
36-5017	Curved	9 in 229 mm



36-5010

Scissors (Dissecting)

Metzenbaum Dissecting Scissors

CODE	DESCRIPTION	LENGTH
54-1023	Curved	5 in 127 mm
54-1021	Curved	5 ¾ in 146 mm
54-1027	Curved	7 in 178 mm
54-1030	Curved	8 in 203 mm
54-1034	Curved	9 in 229 mm
54-1037	Curved	10 in 254 mm
32-3594	Curved	12 ¼ in 311 mm
32-3595	Curved	13 ⅞ in 352 mm
32-3596	Curved, Super Cut	13 ⅞ in 352 mm



54-1021

Thoracoscopy Metzenbaum Dissecting Scissors

CODE	DESCRIPTION	LENGTH
54-1020	Straight	5 ¾ in 146 mm
54-1026	Straight	7 in 178 mm
54-0009	Non-Locking	8 ¼ in 210 mm



54-1020

Nelson Scissors

CODE	DESCRIPTION	LENGTH
54-8025	Straight	9 in 229 mm



Potts-Smith Dissecting Scissors

Rounded Tips, Saber Back Blades

CODE	DESCRIPTION	LENGTH
55-1317	Curved	5 ½ in 140 mm
55-1318	Curved	7 ¼ in 184 mm
55-1319	Curved	9 in 229 mm
55-1320	Curved	11 ¼ in 286 mm



55-1318

Scissors (Endarterectomy)

DeBakey Endarterectomy Scissors

CODE	LENGTH
54-8012	7 in 178 mm



Endarterectomy Scissors

CODE	DESCRIPTION	LENGTH
85-1355	Curved, Serrated	6 3/4 in 171 mm



Ultra™ Endarterectomy Scissors

CODE	DESCRIPTION	LENGTH
55-1374	Slightly Curved	7 in 178 mm



Scissors

Scissors

Titanium, Serrated Jaws

CODE	DESCRIPTION	LENGTH
80-6008	Straight, Fine Tip	6 in 152 mm
80-6009	Straight, Regular Tip	6 in 152 mm



80-6009

Scissors

Titanium, Extra Fine

CODE	DESCRIPTION	LENGTH
80-6640	Straight	6 in 152 mm
80-6641	Curved	6 in 152 mm
80-6642	60° Angle, Straight Blade	6 in 152 mm



80-6640

Questions? Contact us at customerservice@symmetrysurgical.com
or learn more at symmetrysurgical.com

Scissors (Fine)

Fine Scissors

CODE	DESCRIPTION	LENGTH
54-1075	Straight, Sharp/Sharp	4½ in 114 mm
54-1076	Curved, Sharp/Sharp	4½ in 114 mm



54-1075

Scissors (Fine Vascular)

Fine Vascular Scissors

CODE	DESCRIPTION	WIDTH	LENGTH
54-8008	Angled 45°	3/16 x 1/2 in	5.0 x 13 mm 5¼ in 133 mm



Scissors (I.M.A.)

I.M.A. Scissors

Titanium

CODE	DESCRIPTION	LENGTH
80-1854	Straight, 45° Tip	6 in 152 mm
80-1855	Bayonet, 45° Tip	7½ in 191 mm
80-1856	Bayonet, Reverse Angle	7½ in 191 mm



Scissors (Leaflet)

Valve Leaflet Scissors

CODE	DESCRIPTION	LENGTH
55-9089	Blades Angled on Flat 45°	5½ in 140 mm



Scissors (Lobectomy)

Crafoord Lobectomy Scissors

CODE	DESCRIPTION	LENGTH
55-8012	Curved, Blunt Tips	12 in 305 mm



Scissors (MagnaFree®)

MagnaFree® MRI Mayo Scissors

CODE	DESCRIPTION	LENGTH
65-2416	Non-Magnetic, Titanium, for Intraoperative MRI	6¾ in 171 mm



Scissors (Micro)

Double Action Micro Scissors

CODE	DESCRIPTION	LENGTH
55-8700	Straight Blades	7¼ in 184 mm
55-8705	Curved Blades	7¼ in 184 mm



Questions? Contact us at customerservice@symmetrysurgical.com
or learn more at symmetrysurgical.com

Scissors (Micro)

Jacobson Micro Scissors

Angled on Flat

CODE	DESCRIPTION	LENGTH	
55-8710	Angled 25°	7 in	178 mm
55-8711	Angled 45°	7 in	178 mm
55-8712	Angled 60°	7 in	178 mm



55-8710

Micro Scissors

CODE	DESCRIPTION	LENGTH	
80-2005	Straight Tip	5½ in	140 mm
80-2006	Curved Tip	5½ in	140 mm



80-2006

Scissors (Micro Vascular)

Feather Lite Micro Vascular Scissors

CODE	DESCRIPTION	LENGTH	
55-8059FL	45°	7 in	178 mm



Ceramic Coated Micro Vascular Scissors

CODE	DESCRIPTION	LENGTH	
84-8160	25°	7 in	178 mm
84-8059	45°	7 in	178 mm
84-8062	120°	7 in	178 mm



84-8160

Scissors (Microsurgical)

Decker Microsurgical Scissors

Alligator Action

CODE	DESCRIPTION	LENGTH
54-5604	Straight	5½ in 140 mm
54-5605	Curved Left	5½ in 140 mm
54-5606	Curved Right	5½ in 140 mm

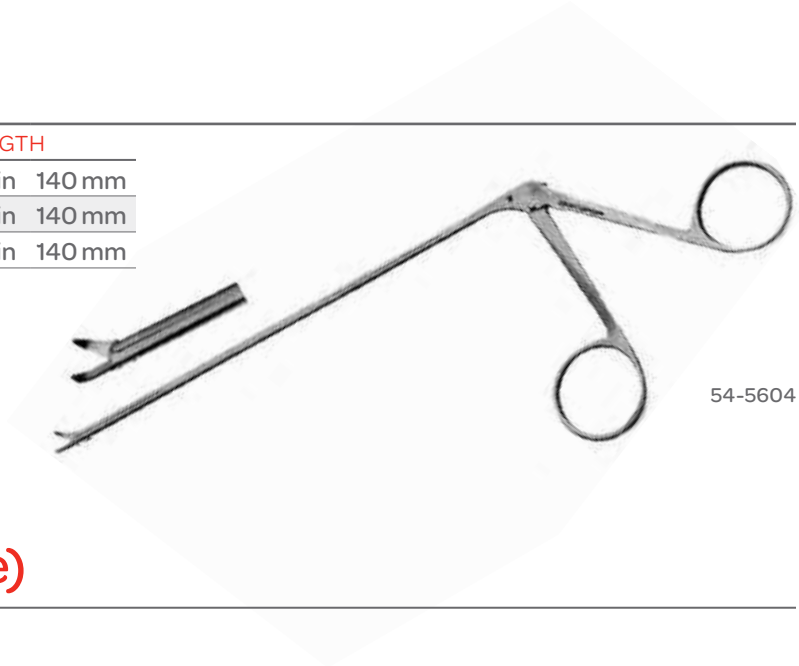

Scissors (Mitral Valve)

Litwak Mitral Valve Scissors

CODE	DESCRIPTION	LENGTH
54-8023	Angled on Side	11 in 279 mm



Scissors (Modified Circumflex)

Lawrie Modified Circumflex Scissors

Without Stabilizing Bar

CODE	DESCRIPTION	BLADE (W X L)	LENGTH
54-8016	130°	⅛ x ½ in 3.0 x 13 mm	7 in 178 mm

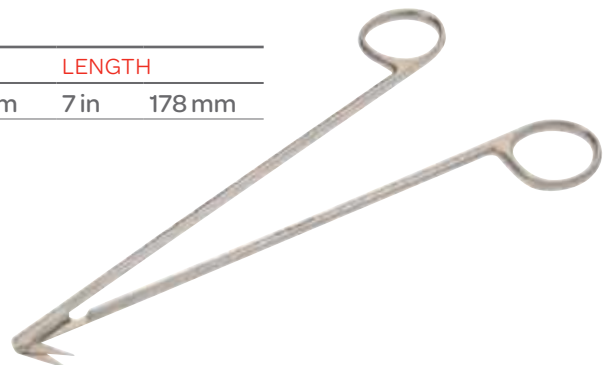

Questions? Contact us at customerservice@symmetrysurgical.com
or learn more at symmetrysurgical.com

Scissors (Operating)

Classic Plus® Operating Scissors

Stellite Edge Inserts, Straight, Sharp

CODE	DESCRIPTION	LENGTH
36-5040	Sharp/Blunt	5½ in 140 mm
36-5041	Sharp/Sharp	5½ in 140 mm



Deaver Operating Scissors

CODE	DESCRIPTION	LENGTH
54-4066	Straight, Sharp/Blunt	5½ in 140 mm



Delicate Operating Scissors

Straight

CODE	DESCRIPTION	LENGTH
54-4301	Sharp/Sharp	5 in 127 mm
54-4300	Sharp/Blunt	5 in 127 mm
54-4306	Sharp/Blunt	5½ in 140 mm



Mixer Operating Scissors

CODE	DESCRIPTION	LENGTH
54-1010	Straight, Blunt/Blunt	6 in 152 mm



Scissors (Operating)

Operating Scissors

Straight

CODE	DESCRIPTION	LENGTH	
54-4027	Sharp/Sharp	5 in	127 mm
54-4030	Sharp/Sharp	5½ in	140 mm
54-4026	Sharp/Blunt	5 in	127 mm
54-4029	Sharp/Blunt	5½ in	140 mm
54-4032	Sharp/Blunt	6 in	152 mm
54-4035	Sharp/Blunt	6½ in	165 mm
54-4028	Blunt, Blunt	5½ in	140 mm
54-4034	Blunt, Blunt	6½ in	165 mm



54-4027

Scissors (Razor)

DeBakey Razor Scissors

Without Serrations, Razor Edge

CODE	DESCRIPTION	HANDLES	LENGTH
80-1043	45°	Black	11 in 279 mm

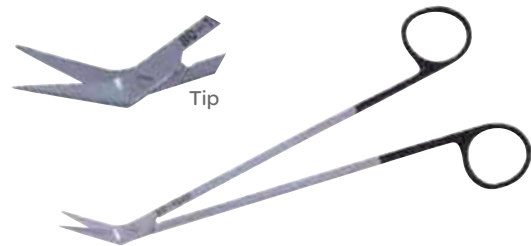

Scissors (Razor Micro)

Diethrich Potts Razor Micro Scissors

Without Serrations, Razor Edge

CODE	DESCRIPTION	HANDLE	LENGTH
80-1543F	45°	Black	7 in 178 mm



Questions? Contact us at customerservice@symmetrysurgical.com
or learn more at symmetrysurgical.com

Scissors (Stitch)

Littauer Stitch Scissors

CODE	DESCRIPTION	LENGTH
54-4017	Stitch Scissors	5½ in 140 mm



Shortbent Stitch Scissors

CODE	DESCRIPTION	LENGTH
54-2555	Curved on Side Razor Edge	3½ in 89 mm



Spencer Stitch Scissors

CODE	DESCRIPTION	LENGTH
54-6624	Stitch Scissors	3½ in 89 mm
54-4205	Stitch Scissors	4½ in 114 mm



54-6624

Wescott Stitch Scissors

CODE	DESCRIPTION	LENGTH
54-6630	Sharp/Sharp	4¼ in 108 mm



Scissors (Stitch)

New Suture Scissors

CODE	DESCRIPTION	LENGTH
54-2550	Angled on Side	5½ in 140 mm



Scissors (Suture)

Wire Classic Plus® Suture Scissors

CODE	DESCRIPTION	LENGTH
36-5080	Stellite Edge Inserts, Angled	4¾ in 121 mm



Scissors (Thoracic Scissor)

Thorek Thoracic Scissors

CODE	DESCRIPTION	LENGTH
51-2519	Strong Curve, Rounded Blades	7½ in 191 mm
51-2523	Strong Curve, Rounded Blades	10 in 254 mm



51-2519

Scissors (Valve)

Diethrich Valve Scissors

Serrated Blades

CODE	DESCRIPTION	LENGTH	
54-8006	Full Curve	9 in	229 mm
54-8005	Slight Curve	9 in	229 mm
67-7665	Dissecting	12 in	305 mm



Thompson Valve Scissors

CODE	DESCRIPTION	LENGTH	
55-8814	Full Curve	10 in	254 mm

Scissors (Vascular)

Classic® Fine Scissors

CODE	DESCRIPTION	LENGTH	
34-1076	Curved	4 ½ in	114 mm



Nelson Classic Plus® Scissors

Stellite Edge Inserts, Curved

CODE	DESCRIPTION	LENGTH	
36-5070	Standard	11 in	279 mm
36-5071	Delicate	11 in	279 mm



Scissors (Vascular)

Arteriotomy Scissors

Flat Handle

CODE	DESCRIPTION	LENGTH
55-9090	Angled 45°	5 ¼ in 133 mm



Church Vascular Scissors

CODE	DESCRIPTION	LENGTH
04-7526	Curved	10 5/8 in 270 mm

DeBakey-Potts-Smith Vascular Scissors

Rounded Tips

CODE	DESCRIPTION	LENGTH
55-1512	Angled 25°	9 in 229 mm
55-1514	Angled 45°	9 in 229 mm
55-1526	Angled 60°	11 in 279 mm

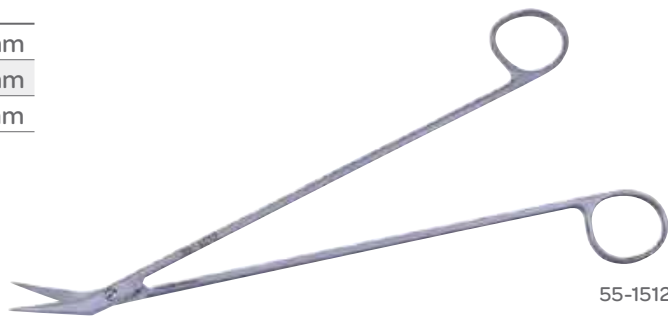

55-1512

DeBakey Scissors

CODE	ANGLE	BLADE (W X L)	LENGTH
54-8035	25°	3/16 x 7/8 in 5.0 x 22 mm	6 ½ in 165 mm
54-8036	45°	3/16 x 7/8 in 5.0 x 22 mm	6 ½ in 165 mm
54-8037	60°	3/16 x 7/8 in 5.0 x 22 mm	6 ½ in 165 mm



54-8035

Questions

comerservice@symmetrysurgical.com
or learn more at symmetrysurgical.com

Scissors (Vascular)

Demartel Scissors

CODE	DESCRIPTION	LENGTH
04-7018	Straight, Sharp/Sharp	6 ¾ in 171 mm
04-7118	Curved, Sharp/Sharp	6 ¾ in 171 mm
04-7119	Curved, Blunt/Blunt	7 in 178 mm



04-7118

Diethrich Potts Scissors

CODE	DESCRIPTION	LENGTH
55-1540	25° Angled Blades	7 ½ in 191 mm
55-1540F	25° Fine Angled Blades	7 ½ in 191 mm

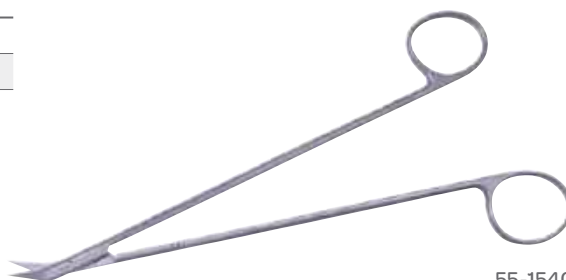

55-1540

Diethrich Scissors

Serrated Blades

CODE	DESCRIPTION	LENGTH
85-2110	25°	7 in 178 mm
85-2113	90°	7 in 178 mm
85-2114	120°	7 in 178 mm



85-2110

Diethrich Scissors

Serrated Blades, Black Handles

CODE	DESCRIPTION	LENGTH
86-1001	25°	7 in 178 mm
86-1002	45°	7 in 178 mm



86-1001

Scissors (Vascular)

Diethrich Scissors

Angled, Serrated Lower Blade, Tungsten Carbide Cutting Edges

CODE	DESCRIPTION	LENGTH	
32-844	25°	7 in	178 mm
32-846	60°	7 in	178 mm
32-848	120°	7 in	178 mm



32-844

Duffield Vascular Scissors

CODE	DESCRIPTION	LENGTH	
04-7425	Straight	10 in	254 mm



Hagemann-Diethrich Vascular Scissors

CODE	DESCRIPTION	LENGTH	
55-1531	Angled 45°	5½ in	140 mm
55-1532	Angled 25°	7 in	178 mm
55-1534	Angled 45°	7 in	178 mm
55-1536	Angled 60°	7 in	178 mm
55-1539	Angled 90°	7 in	178 mm

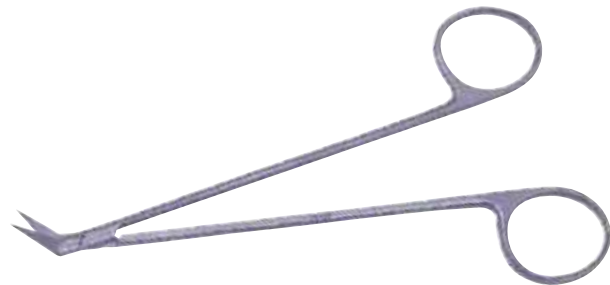

55-1531

Ceramic Coated Diethrich Vascular Scissors

Tungsten Carbide Edges, Ceramic Coating, Razor Edges and Micro Serrations

CODE	DESCRIPTION	LENGTH	
225.15.32	Angled 25°	7¼ in	184 mm
225.15.34	Angled 45°	7⅛ in	181 mm
225.15.36	Angled 60°	7 in	178 mm
225.15.39	Angled 90°	6¾ in	171 mm



225.15.36

Questions? Contact us at customerservice@symmetrysurgical.com
or learn more at symmetrysurgical.com

Scissors (Vascular)

Ceramic Coated Potts-Smith Scissors

Tungsten Carbide Edges, Ceramic Coating, Razor Edges and Micro Serrations

CODE	DESCRIPTION	LENGTH
225.15.43	Angled 25°	7 ¼ in 184 mm
225.15.44	Angled 45	7 ¼ in 184 mm
225.15.46	Angled 60°	7 ¼ in 184 mm



225.15.43

Diethrich Ceramic Coated Vascular Scissors

One Blade with Micro Serrations, Tungsten Carbide Cutting Edges, Black Ceramic Coating

CODE	DESCRIPTION	LENGTH
225.15.40	125°	7 ⅞ in 181 mm



Mattox-Potts Scissors

CODE	DESCRIPTION	BLADE (W X D)	LENGTH
54-8004	45°	¼ x 1 ⅜ in 6.0 x 30 mm	5 ½ in 140 mm



Potts-Smith Scissors

CODE	DESCRIPTION	BLADE (W X D)	LENGTH
54-8002	45°	¼ x 7/8 in 6.0 x 22 mm	7 ½ in 191 mm
54-8003	60°	¼ x 7/8 in 6.0 x 22 mm	7 ½ in 191 mm

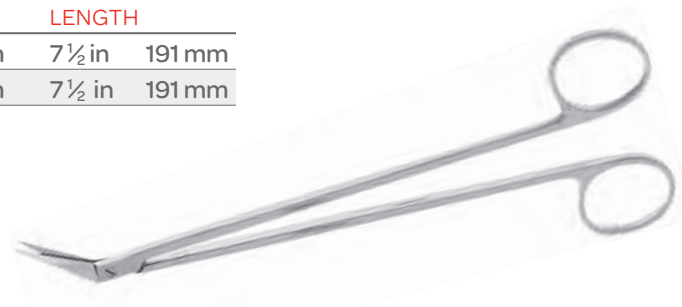

Scissors (Vascular)

Potts-Smith Scissors

Blunt Tips

CODE	DESCRIPTION	LENGTH
55-1032	Angled 25°	7½ in 191 mm
55-1033	Angled 45°	7½ in 191 mm



55-1032

Potts-Smith Scissors

Serrated Blades, Black Handles

CODE	DESCRIPTION	LENGTH
86-1032	25°	7 in 178 mm
86-1033	45°	7 in 178 mm
86-1034	60°	7 in 178 mm



86-1034

Potts-Smith Scissors

Serrated Lower Blade, Tungsten Carbide Cutting Edges

CODE	DESCRIPTION	LENGTH
32-685	Angled 45°	7 in 178 mm
32-686	Angled 90°	7 in 178 mm



32-685

Potts-Smith Scissors

Serrated Lower Blade, Tungsten Carbide Cutting Edges, Regular Blade, Dissecting

CODE	DESCRIPTION	LENGTH
37-4030	Curved	7½ in 191 mm



Scissors (Vascular)

Peripheral Vascular Scissors

CODE	ANGLE	BLADES	LENGTH
55-1007	25°	Short Delicate Blades	5 in 127 mm
55-1009	60°	Short Delicate Blades	5 in 127 mm
55-1010	90°	Short Delicate Blades	5¼ in 133 mm
55-1207	25°	With One Serrated Blade	5 in 127 mm
55-1208	45°	With One Serrated Blade	5 in 127 mm
55-1209	60°	With One Serrated Blade	5 in 127 mm
55-1210	90°	With One Serrated Blade	5 in 127 mm



55-1007

Potts-Smith Scissors

Serrated Blades

CODE	ANGLE	DESCRIPTION	LENGTH
86-1032	25°	Black Handles	7 in 178 mm
86-1033	45°	Black Handles	7 in 178 mm
86-1034	60°	Black Handles	7 in 178 mm



86-1034

Potts-Smith Scissors

CODE	ANGLE	BLADE (W X D)	LENGTH
54-8002	45°	¼ x 7/8 in 6.0 x 22 mm	7½ in 191 mm
54-8003	60°	¼ x 7/8 in 6.0 x 22 mm	7½ in 191 mm

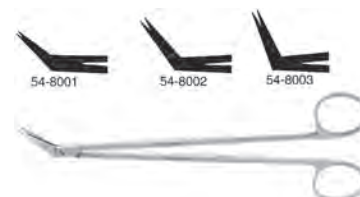

Potts-Smith Scissors

Standard Pattern, Blunt Tips

CODE	DESCRIPTION	LENGTH
55-1032	Angled 25°	7½ in 191 mm
55-1033	Angled 45°	7½ in 191 mm



55-1032

Potts-Smith Scissors

Regular Blade, Dissecting

CODE	DESCRIPTION	LENGTH
37-4030	Curved	7½ in 191 mm



Scissors (Vascular)

Potts-Smith Scissors

With Tungsten Carbide Inserts, Serrated Lower Blade

CODE	ANGLE	LENGTH
32-684	25°	7½ in 191 mm
32-685	45°	7½ in 191 mm
32-686	60°	7½ in 191 mm



32-686

Micro Vascular Scissors

CODE	DESCRIPTION	TIPS	HANDLE	LENGTH
55-8160	Angled 25°	Delicate Tips	Flat	6⅝ in 168 mm
55-8165	Angled 45°	Delicate Tips	Flat	6½ in 165 mm
55-8170	Angled 60°	Delicate Tips	Flat	6¾ in 171 mm
55-8178	Angled 120°	Delicate Tips	Flat	6¼ in 159 mm
55-8062	Angled 120°	Extra Delicate	Round	6¾ in 171 mm
55-8058	Angled 25°	Extra Delicate	Round	7 in 178 mm
55-8059	Angled 45°	Extra Delicate	Round	7 in 178 mm
55-8061	Angled 90°	Extra Delicate	Round	7 in 178 mm
55-8091	Angled 25°	Extra Delicate	Round	8¼ in 210 mm
55-8092	Angled 45°	Extra Delicate	Round	8¼ in 210 mm
55-8094	Angled 90°	Extra Delicate	Round	8¼ in 210 mm
55-8095	Angled 120°	Extra Delicate	Round	8¼ in 210 mm

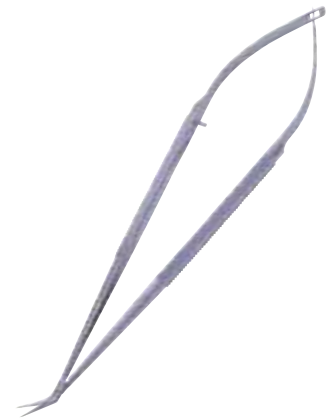

55-8059

“Razor Edge” Diethrich Scissors

Black Handles, Without Serrations, Razor Edge

CODE	DESCRIPTION	LENGTH
80-1001	Angled 25°	7¼ in 184 mm
80-1002	Angled 45°	7¼ in 184 mm
80-1003	Angled 60°	7¼ in 184 mm
80-1005	Angled 120°	7¼ in 184 mm



80-1005

“Razor Edge” Potts-Smith Scissors

Black Handles, Without Serrations, Razor Edge

CODE	DESCRIPTION	LENGTH
80-1032	Angled 25°	7½ in 191 mm
80-1033	Angled 45°	7¼ in 184 mm
80-1034	Angled 60°	7½ in 191 mm



80-1032

Questions? Contact us at customerservice@symmetrysurgical.com
or learn more at symmetrysurgical.com

Scissors (Vascular)

“Razor Edge” Diethrich Scissors with Gold Screw

One Blade with Micro Serrations, Black Handles, Gold Screw

CODE	DESCRIPTION	LENGTH
255.15.42	Angled 25°	7½ in 191 mm
255.15.44	Angled 45°	7½ in 191 mm
255.15.36	Angled 60°	7½ in 191 mm

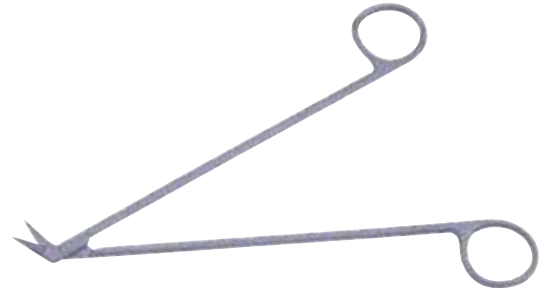

255.15.36

Satinsky Scissors

S-Shaped

CODE	DESCRIPTION	LENGTH
55-1355	Blunt Tips	9¾ in 248 mm

Ultra™ Vascular Scissors

Delicate Blades

CODE	DESCRIPTION	LENGTH
54-8055	Angled 125°	7 in 178 mm
54-8040	Angled 25°	7¼ in 184 mm

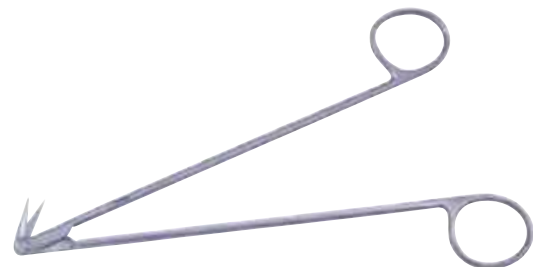

54-8055

Scissors (Wire)

Wire Cutting Suture Scissors

CODE	DESCRIPTION	LENGTH
54-4210	Serrated Blades	4½ in 114 mm



Scissors (Wire)

Wire Suture Scissors

CODE	DESCRIPTION	LENGTH
54-4110	Angled, One Serrated Jaw	4 ³ / ₄ in 121 mm



Shears (Rib Shears)

Bethune Rib Shears

CODE	DESCRIPTION	LENGTH
54-1234	Slightly S-Shaped	13 ³ / ₈ in 340 mm



Gluck Rib Shears

CODE	LENGTH
54-1019	7 ¹ / ₂ in 191 mm



Coryllos Rib Shears

CODE	DESCRIPTION	LENGTH
56-8055	Left	14 in 356 mm
56-8056	Right	14 in 356 mm

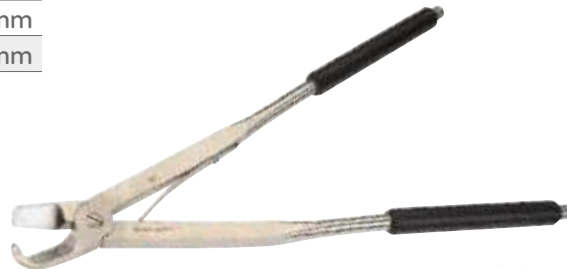

56-8055

Shears (Rib Shears)

Giertz Rib Shears

CODE	LENGTH
54-1525	10 in 254 mm



Sauerbruch Rib Shears

CODE	LENGTH
56-8051	10 1/2 in 267 mm



Stille Giertz Rib Shears

CODE	LENGTH
56-8044	10 in 254 mm



Spatulas (Endarterectomy Spatula)

Endarterectomy Spatula

CODE	DESCRIPTION	LENGTH	
55-9210	Spatula	7 in	178 mm



Jacobson Endarterectomy Spatula

Curved Blade, Semi-Sharp Blade

CODE	DESCRIPTION	LENGTH	
55-7056	1.0x10 mm	7 in	178 mm

Spreaders (Pediatric Rib Spreader)

Haight Pediatric Rib Spreader

CODE	DESCRIPTION	SPREAD	
54-2220	Fenestrated Blades	2½ in	64 mm



Spreaders (Rib Spreader)

Burford Finochietto Rib Spreader

CODE	DESCRIPTION	SPREAD		LENGTH	
54-2343	Stainless Steel	10 in	254 mm		
54-2343B	Small Replacement Blades For 54-2343			2½ x 1¾ in	64 x 44 mm

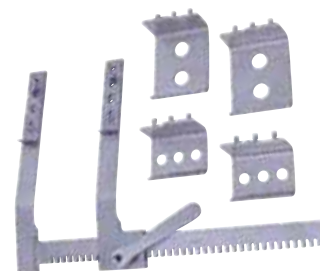

54-2343

Finochietto Rib Spreader

CODE	DESCRIPTION	BLADE (W X D)		SPREAD	
54-2301	Retractor Arms Angled Down	1½ x 1¼ in	38 x 32 mm	6 in	152 mm
54-2302	Retractor Arms Angled Down	2½ x 1¾ in	64 x 44 mm	8 in	203 mm
54-2303	Retractor Arms Angled Down	2½ x 2¾ in	64 x 70 mm	10 in	254 mm



54-2301

Haight-Finochietto Rib Spreader

CODE	DESCRIPTION	SPREAD		LENGTH	
50-8028	Child Size	4 in	102 mm	4 in	102 mm



50-8028

Reinhoff-Finochietto Rib Spreader

CODE	BLADES	SPREAD	
54-2402	1⅛ x 1¼ in 29 x 32 mm	6½ in	165 mm
54-2403	1⅛ x 1¾ in 27 x 44 mm	7½ in	191 mm
54-2404	1⅞ x 1¾ in 48 x 44 mm	8½ in	216 mm



54-2402

Spreaders (Rib Spreader)

Tuffier Rib Spreader

CODE	DESCRIPTION	BLADE (W X D)	SPREAD
54-2241	Scored Blades	1¾ x 2 in 44 x 51 mm	6¼ in 159 mm
54-2242	Serrated Blades	1¾ x 2 in 44 x 51 mm	6¼ in 159 mm



54-2241

Stringers (Instrument Holder)

Bunts Instrument Holder

CODE	DESCRIPTION	LENGTH
28-4008	One Dozen Per Package	3⅞ in 98 mm



Weisenbach Instrument Holder

CODE	DESCRIPTION	LENGTH
28-4010	Forceps Holder	6 in 152 mm



Stringers (Instrument Holder)

Weisenbach Instrument Holder

Instrument Stringer Open End

CODE	WIDTH	LENGTH	CODE	WIDTH	LENGTH
28-4011	2½ in 64 mm	12 in 305 mm	52-0010-6	6 in 152 mm	10 in 254 mm
52-0006	2½ in 64 mm	6 in 152 mm	52-0012	2½ in 64 mm	12 in 305 mm
52-0006-3	3 in 76 mm	6 in 152 mm	52-0012-3	3 in 76 mm	12 in 305 mm
52-0006-4	4 in 102 mm	6 in 152 mm	52-0012-4	4 in 102 mm	12 in 305 mm
52-0006-6	6 in 152 mm	6 in 152 mm	52-0012-6	6 in 152 mm	12 in 305 mm
52-0007	2½ in 64 mm	7 in 178 mm	52-0014	2½ in 64 mm	14 in 356 mm
52-0007-3	3 in 76 mm	7 in 178 mm	52-0014-4	4 in 102 mm	14 in 356 mm
52-0008	2½ in 64 mm	8 in 203 mm	52-0014-6	6 in 152 mm	14 in 356 mm
52-0008-3	3 in 76 mm	8 in 203 mm	52-0016	2½ in 64 mm	16 in 406 mm
52-0008-4	4 in 102 mm	8 in 203 mm	52-0016-5	5 in 127 mm	16 in 406 mm
52-0008-5	5 in 127 mm	8 in 203 mm	52-0018	2½ in 64 mm	18 in 458 mm
52-0010	2½ in 64 mm	10 in 254 mm	52-0018-3	3 in 76 mm	18 in 458 mm
52-0010-4	4 in 102 mm	10 in 254 mm	52-0018-4	4 in 102 mm	18 in 458 mm
52-0010-5	5 in 127 mm	10 in 254 mm			



28-4011

Stringers (Instrument Holder)

Rhode Island Hospital Instrument Holder

CODE	DESCRIPTION	LENGTH
21-4003	Instrument Holder	12 in 305 mm



Stringers (Instrument Holder)

Sterilization Rack

CODE	DESCRIPTION	LENGTH
32-3345	For Ring Handle Forceps	12 x 3 in 305 x 76 mm
32-3346	For Ring Handle Forceps	5 ⁷ / ₈ x 3 ¹ / ₈ 149 x 79 mm
32-3347	For Ring Handle Forceps	7 ⁷ / ₈ x 3 ¹ / ₈ 200 x 79 mm
32-3348	For Ring Handle Forceps	9 ⁷ / ₈ x 3 ¹ / ₈ 251 x 79 mm



32-3345

Strippers

Disposable Vein Stripper

Sterile, Each Package Includes Three Olives (S,M,L), One Handle and Two Stripper Cables

CODE	DESCRIPTION	LENGTH
63-4031	Disposable Vein Stripper	³ / ₈ in 10 mm



Endarterectomy Strippers



09-9619

Endarterectomy Stripper

CODE	DESCRIPTION	LENGTH	CODE	DESCRIPTION	LENGTH
09-9602	2.0 mm	21 ¹ / ₁₆ in 535 mm	09-9609	9.0 mm	21 ³ / ₄ in 552 mm
09-9603	3.0 mm	21 ¹ / ₁₆ in 535 mm	09-9610	10 mm	21 ³ / ₄ in 552 mm
09-9604	4.0 mm	21 ¹ / ₁₆ in 535 mm	09-9611	11 mm	21 ³ / ₄ in 552 mm
09-9605	5.0 mm	21 ¹ / ₁₆ in 535 mm	09-9612	12 mm	21 ³ / ₄ in 552 mm
09-9606	6.0 mm	21 ¹ / ₁₆ in 535 mm	09-9613	14 mm	21 ³ / ₄ in 552 mm
09-9607	7.0 mm	21 ¹ / ₁₆ in 535 mm	09-9619	Handle	21 ³ / ₄ in 552 mm
09-9608	8.0 mm	21 ¹ / ₁₆ in 535 mm			

Vein Strippers

Mayo Vein Stripper

CODE	DESCRIPTION	DIAMETER	LENGTH
09-9581	Angled Shaft	4.8 mm	15 ³ / ₈ in 391 mm



Questions? Contact us at customerservice@symmetrysurgical.com
or learn more at symmetrysurgical.com

Suction Tubes (Sump)

Opti-Length® Left Ventricular Sump

CODE	DESCRIPTION	TIP WIDTH	LENGTH
67-7677	45°, Perforated	5/16 in 8.0 mm	19 3/4 in 502 mm

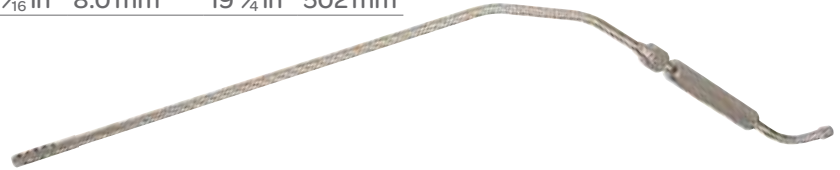

Suction Tubes

Andrews-Pynchon Suction Tube, Opti-Length® Suction

CODE	DESCRIPTION	LENGTH
70-6560	Suction Tube	9 1/2 in 241 mm
67-7675	Suction Tube	11 in 279 mm



70-6560

Pacifico Suction Tube

Diameter Tapers 11-8, French Width 5/8 in (22 mm)

CODE	DESCRIPTION	LENGTH
70-8048	Large	7 1/2 in 191 mm



Pool Suction Tube

CODE	DESCRIPTION	LENGTH
70-4000	Curved Tubing Connection	23 Fr x 9 1/4 in 23 Fr x 235 mm
70-4001	Straight Tubing Connection	30 Fr x 9 5/8 in 30 Fr x 244 mm
70-4002	Straight Tubing Connection, with Finger Cut-Off	30 Fr x 10 1/4 in 30 Fr x 260 mm

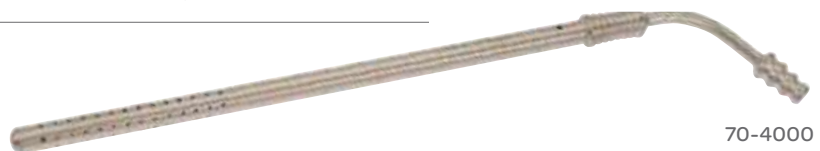

70-4000

Suction Tubes

Suction Tube

CODE	WORKING DISTANCE		LENGTH	
32-3360	9 ³ / ₄ in	248 mm	12 in	305 mm
32-3361	12 ³ / ₄ in	324 mm	15 in	381 mm



32-3360

Yankauer Suction Tubes

CODE	DESCRIPTION	WORKING DISTANCE		LENGTH	
70-4026	Removable Tip, Standard			10 ³ / ₈ in	264 mm
70-4024	With Thumb Control			11 ¹ / ₄ in	286 mm
32-3362	With Thumb Control	5 ⁷ / ₈ in	149 mm	12 ³ / ₄ in	324 mm

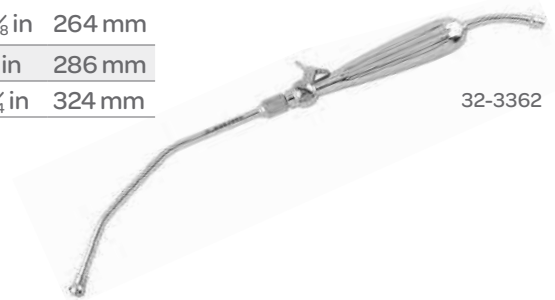

32-3362

Suction Tubes (Holders)

Green Suction Tube Holder

CODE	DESCRIPTION	LENGTH	
70-4142	Tube Holder	6 ¹ / ₂ in	165 mm



Suction Tubes (Vascular)

Methodist Vascular Suction Tube

CODE	DESCRIPTION	LENGTH	
70-8040	Diameter ³ / ₈ in (10 mm)	10 in	254 mm



Suction Tubes (Vascular)

Vascular Suction Tube

CODE	DESCRIPTION	DIAMETER	LENGTH
54-6038	Angled		11 in 279 mm
70-8036	Round Perforated End	¼ in 6.0 mm	11½ in 292 mm



Sump Suction

Cooley Right Angle Sump Suction Tube

CODE	DESCRIPTION
54-6013	Right Angle Sump Suction

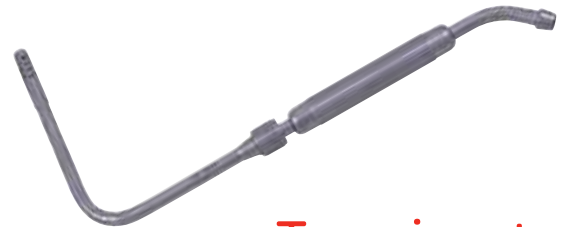

Tourniquets

Rumel Cardiovascular Tourniquets

CODE	DESCRIPTION	LENGTH
67-8004	Child, Obturator Only	6 in 152 mm
67-8001	Adult, Obturator Only	9 in 229 mm
67-8000	Adult, with Ratchet and Tourniquet with Obturator	12 in 305 mm



Trocars

Hurwitz Thoracic Trocar

CODE	SIZE	GAUGE	LENGTH
54-7003	Large	36 French, Up to 26 French Foley	8 in 203 mm



Nelson (Patterson) Trocar

CODE	SIZE	GAUGE	LENGTH
54-7007	Small	18 French	¼ in 6.0 mm
54-7005	Medium-Large	32 French	¾ in 10 mm
54-7004	Large, for Intercostal Drainage	36 French	7/16 in 11 mm



Tunnelers (A-V Fistula)

Noon A-V Fistula Tunneler

CODE	DESCRIPTION	LENGTH	
80-8006	Tunneler	9 in	229 mm



Tunnelers (Cone Tip)

Bullet Cone Tip Tunneler

With Removable Tip

CODE	DESCRIPTION	LENGTH	
55-6710	Slightly Curved	11 ³ / ₄ in	298 mm
55-6712	Slightly Curved	15 ³ / ₄ in	400 mm
55-6714	Slightly Curved	19 ³ / ₄ in	502 mm
55-6716	Slightly Curved	27 ¹ / ₂ in	699 mm

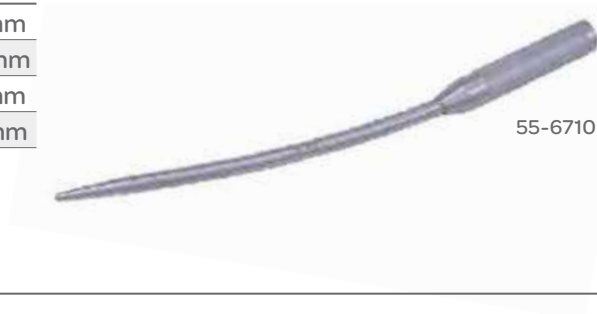

Tunnelers

Crawford-Cooley Tunneler

CODE	DESCRIPTION	LENGTH	
55-6083	Tube Is 400 mm Long, 12 mm in Diameter	18 in	458 mm



Tunnelers (Tunneling Forceps)

Hallman Tunneling Forceps

CODE	DESCRIPTION	LENGTH	
55-6086	Tunneling Forceps	14 in	356 mm

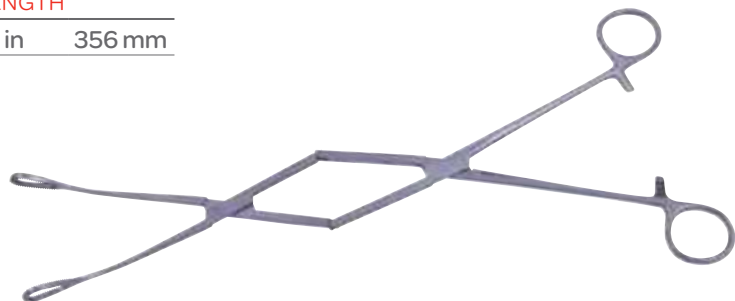

Questions? Contact us at customerservice@symmetrysurgical.com
or learn more at symmetrysurgical.com

Valvulotomes

Valvulotome

CODE	DESCRIPTION	LENGTH
55-8681	Antegrade	6 ¼ in 159 mm
55-8683	Antegrade	12 in 305 mm
55-8685	Retrograde	6 ¼ in 159 mm
55-8680	Retrograde	9 ½ in 241 mm
55-8682	Retrograde	12 in 305 mm

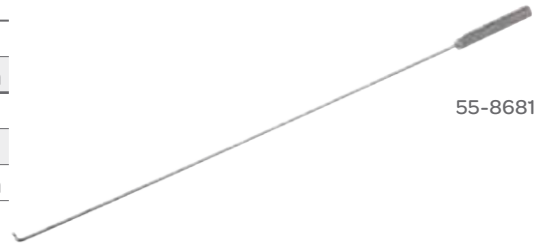

55-8681

Wire & Pin Cutters

Ochsner Wire Twister

CODE	DESCRIPTION	LENGTH
73-4005	Threaded Shaft for Rotation, Tungsten Carbide Jaw Inserts	10 ½ in 267 mm



Wire Cutter

CODE	DESCRIPTION	LENGTH
56-2510	Stainless Steel	7 in 178 mm



Wire Cutter, Double Action Side Cut

CODE	DESCRIPTION	LENGTH
32-3371	Straight Jaw	9 in 229 mm
32-3372	Angled Jaw	6 ½ in 165 mm
32-3373	Angled Jaw	9 in 229 mm



32-3372

Wire Cutters

CODE	DESCRIPTION	LENGTH
32-3341	Tungsten Carbide Inserts	7 in 178 mm

