



Scan the code above to learn more about our Orthopedics and Arthroscopy portfolio.

Orthopedics & Arthroscopy Portfolio



symmetry surgical™

Orthopedics & Arthroscopy



Calipers	O/A-2	Gouges	O/A-42	Reamers	O/A-77
Casts Tools	O/A-2	Graspers	O/A-46	Retractors	O/A-78
Cement Impaction	O/A-2	Handles	O/A-46	Rongeurs	O/A-94
Chisels	O/A-3	Hooks	O/A-47	Scissors	O/A-106
Clamps	O/A-7	Impactors	O/A-49	Shuttles	O/A-107
Containers	O/A-9	Kits	O/A-50	Skids	O/A-107
Curettes	O/A-13	Knives	O/A-57	Splitters	O/A-108
Cutters	O/A-16	Mallets	O/A-57	Tamps	O/A-109
Dissectors	O/A-16	Manipulators	O/A-62	Taps	O/A-110
Drivers	O/A-17	Osteotomes	O/A-62	Wire & Traction	O/A-110
Elevators	O/A-19	Picks	O/A-70		
Endoscopes	O/A-29	Plaster Tools	O/A-70		
Extractors	O/A-29	Probes	O/A-71		
Files	O/A-31	Punches	O/A-71		
Forceps	O/A-33	Rasps	O/A-76		

Questions? Contact us at customerservice@symmetrysurgical.com or learn more at symmetrysurgical.com



The Surgical Instrument Desk Reference

How to Use Our Catalog

The Symmetry Surgical catalog is designed with you in mind, to be your trusted resource for surgical instrumentation. We took great care in creating an easy-to-use, robust catalog and we think you'll be pleased with the design as you become more familiar with our broad portfolio.

Layout

The catalog is organized by surgical specialty *and* product function.

And we know that it is difficult to pick up an instrument and know what specialty it's listed in. To make your job easier, we've sorted the instruments in our portfolio by surgical function, too, including Energy, Laparoscopic, Retractors and Sterilization Solutions.

U.S. Customer Service

Your Symmetry Surgical Customer Service team wants to make ordering surgical instruments the easiest part of your day. We accept orders via phone, fax, email, our website, Global Healthcare Exchange (GHX) and through the mail.

PHONE

1.800.251.3000

(Available Monday through Friday, 8:30 AM–6:30 PM EST)

FAX

1.800.342.3272

EMAIL

customerservice@symmetrysurgical.com

ONLINE

symmetrysurgical.com

MAILING ADDRESS

Symmetry Surgical
Attn: Customer Service
3034 Owen Drive
Antioch, TN 37013

The Surgical Instrument Desk Reference

International Customer Service

PHONE

Symmetry Surgical Switzerland GmbH
+41 (0) 52 557 59 00
(Available Monday through Friday, 7:00-16:00 GMT)

Symmetry Surgical, Inc., USA
1.615.964.5672
(Available Monday through Friday, 8:30 AM–6:30 PM EST)

FAX

Symmetry Surgical Switzerland GmbH
+41 (0) 52 557 59 99

EMAIL

customerservice@symmetrysurgical.com
internationalorders@symmetrysurgical.com

ONLINE

symmetrysurgical.com

MAILING ADDRESS

Symmetry Surgical Switzerland GmbH
Bühlstrasse 27
CH-8200 Schaffhausen
Switzerland

Symmetry Surgical, Inc.
3034 Owen Drive
Antioch, TN 37013

INTERNATIONAL PAYMENT TERMS/RETURN GOODS POLICY/INSTRUMENT REPAIR & RESTORE PROGRAM/LITERATURE REQUESTS

Please contact your local distributor. Locate a local distributor contact, International Customer Service at +41 (0) 52 557 59 00 or 1.615.964.5672 (US).

Cardiovascular/Thoracic

Energy

Ear, Nose & Throat

General

Laparoscopic

Neurology

Obesity

OB/GYN

Ophthalmology

Orthopedics & Arthroscopy

Pediatrics

Rectal

Retractors

Spine

Urology

Sterilization Solutions

Alphabetical & Numeric Indexes

Calipers (Patella)

Patella Calipers

CODE	DESCRIPTION
14-016-000	Calibrations range from 0 to 30 mm



Cast Tools (Breaker)

Wolfe-Boehler Cast Breaker

CODE	LENGTH
11-2095	10 in 254 mm



Cast Tools (Plaster)

Beeson Plaster Spreader & Hennig Plaster Spreader

CODE	DESCRIPTION	LENGTH
40-7130	Serrated	11 ³ / ₄ in 298 mm
40-7027	Serrated	11 in 279 mm



Cement Impaction (Tibial)

Cement Well

CODE	DESCRIPTION
10-152-000	Small
10-153-000	Medium
10-154-000	Large



10-152-000

Cement Impaction (Tibial)

Compression Base

CODE	DESCRIPTION
10-149-000	Small
10-150-000	Medium
10-151-000	Large



Tibial Perforator

CODE	DESCRIPTION
10-155-000	Small
10-156-000	Medium
10-157-000	Large



10-155-000

Chisels (Acetubular)

Acetabular Chisel

CODE	DESCRIPTION
10-010-000	Curved



10-010-000

Chisels (Bone)

Alexander Chisel

CODE	DESCRIPTION	TIP	LENGTH
28-2606	Straight	¼in 6mm	7in 178mm



Chisels (Bone)

Bishop Chisel

CODE	DESCRIPTION	TIP WIDTH	LENGTH
27-6004	Straight	$\frac{1}{8}$ in 4 mm	6 in 150 mm



Bishop Chisel

CODE	DESCRIPTION
29-0401	#3, Stout



Chisel

Straight Stiletto

CODE	DESCRIPTION	TIP	LENGTH
67-7018		$\frac{3}{4}$ in 19 mm	9 $\frac{1}{2}$ in 241 mm



Chisel

CODE	DESCRIPTION	TIP	LENGTH
18-1011	Straight	$\frac{15}{64}$ in 6 mm	9 $\frac{1}{2}$ in 241 mm



Chisels (Bone)

Chisel

CODE	DESCRIPTION	TIP	LENGTH
10-015-000	Offset		
10-003-000		1/3 in 8 mm	17 in 432 mm



10-015-000

Hibbs Chisel

CODE	DESCRIPTION	TIP	LENGTH
28-5006	Straight	1/4 in 6 mm	9 1/2 in 241 mm
28-5010	Straight	3/8 in 10 mm	9 1/2 in 241 mm
28-5012	Straight	1/2 in 13 mm	9 1/2 in 241 mm
28-5016	Straight	5/8 in 16 mm	9 1/2 in 241 mm
28-5020	Straight	3/4 in 19 mm	9 1/2 in 241 mm
28-5025	Straight	1 in 25 mm	9 1/2 in 241 mm
28-5056	Curved	1/4 in 6 mm	9 1/2 in 241 mm
28-5062	Curved	1/2 in 13 mm	9 1/2 in 241 mm
28-5070	Curved	3/4 in 19 mm	9 1/2 in 241 mm
28-5075	Curved	1 in 25 mm	9 1/2 in 241 mm
28-5032	Curved	1 1/4 in 32 mm	9 1/2 in 241 mm

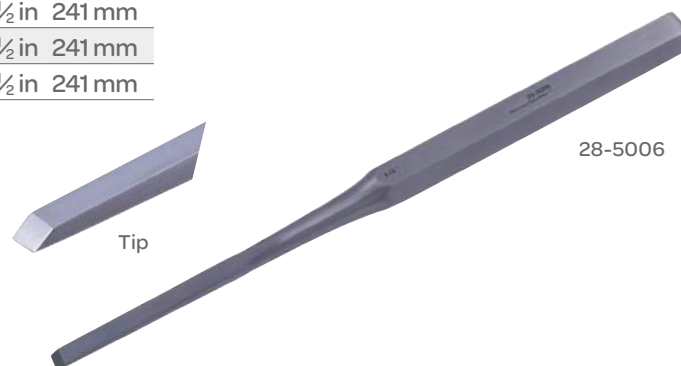

28-5006

Lexer Chisel

CODE	DESCRIPTION	TIP	LENGTH
28-5407	Straight, Phenolic	1/4 in 6 mm	7 in 178 mm
28-5410	Straight, Phenolic	3/8 in 8 mm	7 in 178 mm
28-5412	Straight, Phenolic	3/8 in 10 mm	7 in 178 mm
28-5433	Straight, Phenolic	3/8 in 10 mm	8 5/8 in 219 mm
28-5435	Straight, Phenolic	3/4 in 15 mm	8 5/8 in 219 mm
28-5439	Straight, Phenolic	1 in 30 mm	8 5/8 in 219 mm



28-5407

Chisels (Bone)

Stiletto Chisel

CODE	DESCRIPTION	TIP	LENGTH
46-3071	Straight	¼ in 6 mm	8½ in 216 mm
46-3072	Straight	⅜ in 10 mm	8½ in 216 mm
46-3073	Straight	½ in 13 mm	8½ in 216 mm
46-3074	Straight	⅝ in 16 mm	8½ in 216 mm
46-3075	Straight	¾ in 19 mm	8½ in 216 mm
46-3083	Curved	½ in 13 mm	8½ in 216 mm
46-3085	Curved	¾ in 19 mm	8½ in 216 mm



46-3075

Stille Chisel

CODE	DESCRIPTION	TIP	LENGTH
28-4320	Straight	¾ in 19 mm	8 in 203 mm
28-4325	Straight	1 in 25 mm	8 in 203 mm

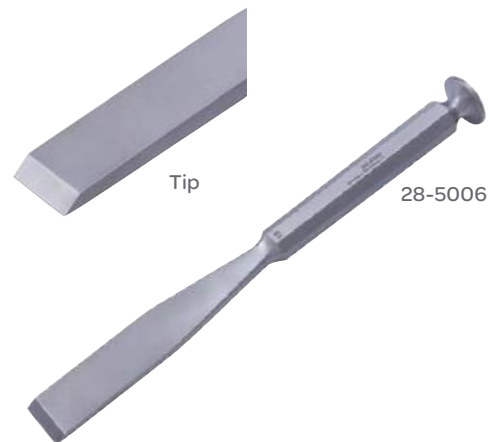

Tip

28-5006

Thin Chisel Blade

Flexible Chisel Blade

CODE	TIP
11-025-000	2½ x 8 mm
11-026-000	2½ x 10 mm
11-027-000	2½ x 12 mm
11-028-000	2½ x 20 mm



11-025-000

Chisels (Bone)

U.S. Army Chisel

CODE	DESCRIPTION	TIP	LENGTH
28-2006	Straight	6 mm	6 ¼ in 159 mm
28-2012	Straight	12 mm	6 ¼ in 159 mm
28-2018	Straight	18 mm	6 ¼ in 159 mm

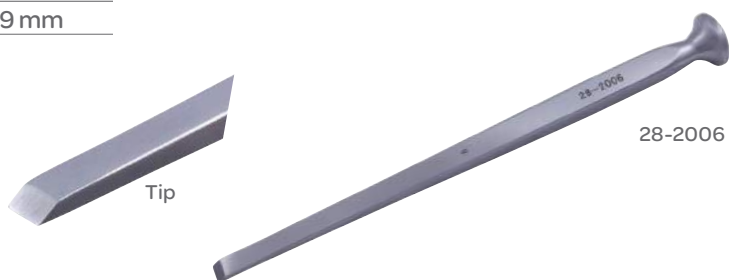

Clamps (Bone Holding)

Lowman Bone Holding Clamp

CODE	DESCRIPTION	LENGTH
35-8018	1x2 Prongs	7 ¼ in 185 mm
35-8020	1x2 Prongs	8 in 200 mm



Lowman Bone Holding Clamp

CODE	DESCRIPTION	LENGTH
35-8215	1x1 Prongs	4 ¾ in 120 mm
35-8025	1x1 Prongs	7 ¼ in 185 mm
35-8026	1x1 Prongs	8 in 200 mm



Clamps (Cartilage)

Martin Cartilage Clamp

CODE	LENGTH
35-2116	6¼ in 160 mm
35-2119	7¼ in 185 mm
35-2120	8 in 200 mm



Walton Cartilage Clamp

CODE	DESCRIPTION	LENGTH
35-2150	Slight Curve	8 in 200 mm



Clamps (Internal Fixation)

Internal Fixation Clamp

CODE	DESCRIPTION	LENGTH
35-1130	With Pin Holder	6 in 150 mm



Clamps (Meniscus)

Meniscus Clamp

CODE	DESCRIPTION	LENGTH
37-4007	1x2 Teeth	7 1/8 in 181 mm



Containers

For a comprehensive listing of our sterilization portfolio, visit the Sterilization Solutions section of our catalog.

Containers (Arthroscope)

Combination Arthroscope Case

CODE	DESCRIPTION	DIMENSIONS
3-7110	Combination Arthroscope Case	10 1/2 x 6 1/4 x 1 9/25 in 257 x 159 x 34 mm



Containers (Arthroscope & Cable)

Arthroscopy Scope & Cable Case

CODE	DESCRIPTION	DIMENSIONS
3-5120	Arthroscopy Scope and Cable Case	16 9/10 x 6 1/10 x 1 1/2 in 430 x 155.5 x 39.5 mm

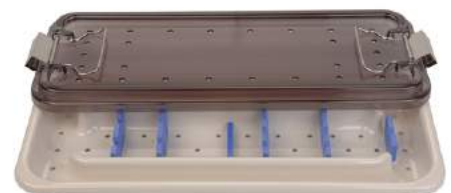

Containers (Delivery)

Delivery Case

CODE	DESCRIPTION	LENGTH
25-006-000	For Use with Hip Revision System	6 in 150 mm



Containers (Drill)

Drill Tray

For Use with Ultra™ Container

CODE	DESCRIPTION	DIMENSIONS
B1212-DRILL	Aluminum	12x12x8 in 304x304x203 mm



Containers (Gouge & Osteotome)

Gouge & Osteotome Case

CODE	DIMENSIONS
21-2500	9 x 6 $\frac{7}{8}$ x 2 $\frac{1}{4}$ in 229 x 175 x 57 mm



Containers (Modular)

Modular Hand Held Instrument Case

CODE	DESCRIPTION	DIMENSIONS (INTERNAL)	
5-1150	Modular Hand Held Instrument Case	18 ¼ x 7 ½ x 2 ¾ in	464 x 190 x 70 mm



Containers (MultiPak)

MultiPak 20 in (508 mm) Endoscopic Kit*

CODE	DESCRIPTION	QTY
5500	20 in Endoscopic Kit Includes:	
5000-01-475P	Base	1/Kit
5000-50-175P	Lid	1/Kit
5111	Wire Rack	1/Kit
5022	Insert Tray	1/Kit
5200	Bar Holders	4/Kit
5233	"T" Brackets, and Hardware Insert Tray	4/Kit

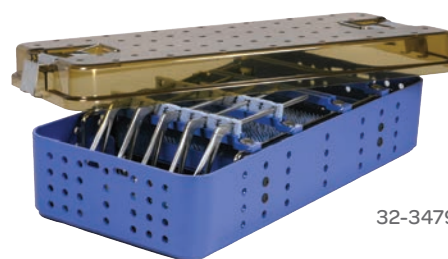

32-3479

*Instruments and silicone parts are not included

Containers (Rongeur Rack)

Rongeur Rack

CODE	DESCRIPTION
B2175-RONGEUR	For Endoscopic Container C22856

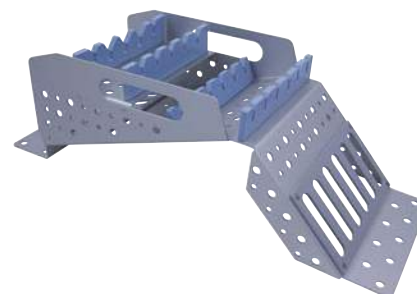

Containers (Sterilization Case)

Sterilization Case

CODE	DESCRIPTION	DIMENSIONS	LENGTH
46-3086	Case For Curved Stiletto Chisels		
46-3056	Case For Curved Stiletto Osteotomes		8 ½ in 216 mm
46-3060	Case For Straight Stiletto Osteotomes, Kit		8 ½ in 216 mm
25-035-000	For Acetabular Prep 30-033-000		
25-022-000	For Complete Extractor Tray 30-035-000		
25-034-000	For Complete MIK Retractor System 30-032-000		
25-024-000	For Flexible Osteotome System-Set 30-005-000		
25-028-000	For Hip Retractor (Hybrid) Set 30-034-000		
25-015-000	For Screw Removal System 30-009-000		
21-1020	Sterilizing & Carrying Case Holds 8 Gouges or Osteotomes	8 7/8 x 1 ¼ in	225 x 32 mm
46-3066	Stiletto Straight Osteotome Case		8 ½ in 216 mm



Containers (Tray)

Shutt Tray

CODE	DESCRIPTION	DIMENSIONS
B-SHUTT	Aluminum, For Use with C18138	17 x 12 x 6 in 432 x 305 x 152 mm



Containers (Tray)

Universal Hand Held Case & Lid

CODE	LENGTH
5-1110	13½ x 8 ⅘ x 2½ in 343 x 224 x 64 mm



Container Accessories (Rack)

Arthroscopy Rack

CODE	DESCRIPTION
ARTH-RACK	For Use with B-Shutt, Holds 15 Instruments

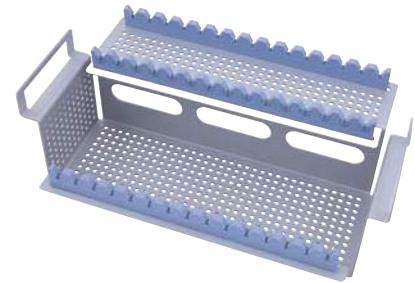

Curettes (Arthroscopic)

Curette

In-line Handle, Round

CODE	DESCRIPTION	WORKING DIAMETER	WORKING LENGTH
1010801	Open 4 mm	4.9 mm	4 9/16 in 116 mm
1010802	Open 7 mm	6.9 mm	4 9/16 in 116 mm



Curettes (Bone)

Bone Curette

CODE	DESCRIPTION	CUP	LENGTH	
29-7076	Straight	3.6 mm	10 in	250 mm
29-7077	Straight	4.4 mm	10 in	250 mm
29-7078	Straight	5.2 mm	10 in	250 mm
29-7079	Straight	6 mm	11 in	279 mm
29-7071	Angled	4.4 mm	10 in	250 mm
29-7072	Angled	5.2 mm	10 in	250 mm
29-7073	Angled	6 mm	10 in	250 mm



Bone Curette

CODE	DESCRIPTION	LENGTH
29-4906	Oval Cup, 6 mm	7 in 178 mm



Bruns Curette

Reverse Angle, Hollow Handle

CODE	CUP SIZE	LENGTH
32-3490	#0000 3 mm	9 in 229 mm
32-3491	#000 3.2 mm	9 in 229 mm
32-3492	#00 3.4 mm	9 in 229 mm
32-3493	#0 3.7 mm	9 in 229 mm
32-3494	#1 4.7 mm	9 in 229 mm
32-3495	#2 5.7 mm	9 in 229 mm
32-3496	#3 7 mm	9 in 229 mm
32-3497	#4 8.4 mm	9 in 229 mm
32-3498	#5 8.9 mm	9 in 229 mm
32-3499	#6 10.2 mm	9 in 229 mm



Bruns Curette

Straight, Hexagonal Handle

CODE	CUP SIZE	LENGTH
32-3400	#000 3.2 mm	9 in 229 mm
32-3401	#00 3.4 mm	9 in 229 mm
32-3402	#0 3.7 mm	9 in 229 mm
32-3403	#1 4.7 mm	9 in 229 mm
32-3404	#2 5.7 mm	9 in 229 mm
32-3405	#3 7 mm	9 in 229 mm
32-3407	#4 8.4 mm	9 in 229 mm
32-3406	#5 8.9 mm	9 in 229 mm
32-3408	#6 10.2 mm	9 in 229 mm



Curettes (Bone)

Bruns Curette

Straight, Hollow Handle

CODE	CUP SIZE	LENGTH
32-3470	#0000 3 mm	9 in 229 mm
32-3471	#000 3.2 mm	9 in 229 mm
32-3472	#00 3.4 mm	9 in 229 mm
32-3473	#0 3.7 mm	9 in 229 mm
32-3474	#1 4.7 mm	9 in 229 mm
32-3475	#2 5.7 mm	9 in 229 mm
32-3476	#3 7 mm	9 in 229 mm
32-3477	#4 8.4 mm	9 in 229 mm
32-3478	#5 8.9 mm	9 in 229 mm
32-3479	#6 10.2 mm	9 in 229 mm



Bruns Curette

Forward Angle, Hollow Handle

CODE	CUP SIZE	LENGTH
32-3480	#0000 3 mm	9 in 229 mm
32-3481	#000 3.3 mm	9 in 229 mm
32-3482	#00 3.9 mm	9 in 229 mm
32-3483	#0 4.5 mm	9 in 229 mm
32-3484	#1 5.3 mm	9 in 229 mm
32-3485	#2 6 mm	9 in 229 mm
32-3486	#3 7.3 mm	9 in 229 mm
32-3487	#4 8.2 mm	9 in 229 mm
32-3488	#5 9.8 mm	9 in 229 mm
32-3489	#6 12.5 mm	9 in 229 mm



Cobb Curette

CODE	SIZE	TIP	LENGTH
23-2570	#000	3.25 mm	11 in 279 mm
23-2571	#00	4 mm	11 in 279 mm
23-2572	#0	5 mm	11 in 279 mm
23-2573	#1	6 mm	11 in 279 mm
23-2574	#2	7.5 mm	11 in 279 mm
23-2575	#3	9 mm	11 in 279 mm
23-2576	#4	11.5 mm	11 in 279 mm
23-2577	#5	13 mm	11 in 279 mm
23-2578	#6	15.5 mm	11 in 279 mm

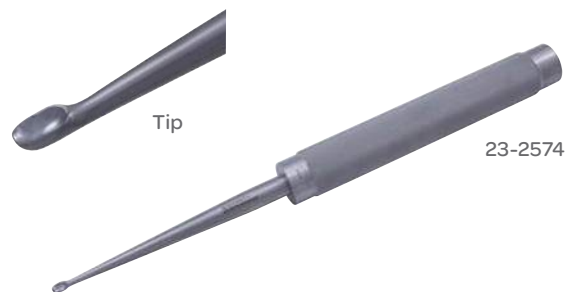

Curettes (Bone)

Hip Revision Reverse Curette

CODE	TIP	LENGTH
10-054-000	6 mm	17 in 432 mm
10-006-000	7 mm	17 in 432 mm
10-007-000	9 mm	17 in 432 mm
10-055-000	11 mm	17 in 432 mm



Cutters (Arthroscopic)

Suture Cutter

CODE
1000647
1000688
1021101



Dissectors

Periosteal Elevator

CODE	DESCRIPTION	BLADE WIDTH	LENGTH
65-1121	Sharp	$\frac{3}{16}$ in 5 mm	8 in 203 mm



Drivers (Calcar)

Calcar Driver

CODE	DESCRIPTION	LENGTH
11-074-000	Tri-Shank End	1½ in 38 mm



Drivers (Flexible)

Flexible Hex Driver

CODE	DESCRIPTION	LENGTH
09-147-000	¼ in Square Drive	4 mm



Drivers (Hand-Operated)

Hudson T-Handle

CODE	DESCRIPTION
10-022-000	Driver



Drivers (Hex)

Hex Driver

CODE	DESCRIPTION
10-114-000	2.5 mm
10-115-000	3.5 mm
10-117-000	1.5 mm



10-114-000

Drivers (Hex)

Universal Hex Driver

CODE	DESCRIPTION	LENGTH
09-142-000	¼ in Square Drive	3.5 mm
09-143-000	¼ in Square Drive	4 mm



09-143-000

Drivers (Universal Handle)

Universal Driver Handle

CODE
10-113-000



42.5° Driver

Bayonet

CODE	DESCRIPTION
09-078-000	½ in, Hudson Connection



Screwdriver

CODE	DESCRIPTION
10-120-000	(A/O), Straight
10-141-000	Cruciform (A/O), Mini
10-119-000	Cruciform (A/O), Small



10-120-000

Elevators



Molt Periosteal Elevator

CODE	DESCRIPTION	LENGTH	
26-3700	#9	7¼ in	185 mm
32-3420	#9	7¼ in	185 mm



Oldberg Dissector

CODE	LENGTH
26-4809	7 in 175 mm

Elevators (Metatarsal)



Chandler Elevator

26-5621

CODE	DESCRIPTION	BLADE WIDTH		LENGTH	
26-5621	Blunt	½ in	13 mm	7½ in	190 mm
26-5622	Blunt	¾ in	19 mm	8 in	200 mm
26-5623	Blunt	1 in	25 mm	9 in	230 mm
26-5624	Blunt	1⅜ in	30 mm	10 in	250 mm
26-5625	Slight Curve	1 in	25 mm	7½ in	190 mm

Elevators (Metatarsal)



Cloward Periosteal Elevator

CODE	DESCRIPTION	BLADE WIDTH	LENGTH
26-2777	#4	½ in 13 mm	7¾ in 195 mm



26-5500

Crego Elevator

CODE	DESCRIPTION	BLADE WIDTH	LENGTH
26-5500	Blunt, Full Curve	⅝ in 16 mm	7½ in 190 mm
26-5503	Blunt, Slight	⅝ in 16 mm	8 in 200 mm



78-5011

McGlamary Metatarsal Elevator

CODE	DESCRIPTION	BLADE WIDTH	LENGTH
78-5009	Sharp	⅜ in 10 mm	6¼ in 160 mm
78-5011	Sharp	⅞ in 11 mm	6¼ in 160 mm
78-5013	Sharp	½ in 13 mm	6¼ in 160 mm
78-5015	Sharp	⅝ in 16 mm	6¼ in 160 mm
78-5017	Sharp	⅞ in 17 mm	6¼ in 160 mm

Elevators (Osteophyte)



57-5038

Osteophyte Periosteal Elevator

CODE	DESCRIPTION	LENGTH	
57-5038	90° Tip	8 in	200 mm
57-5039	Curved, Rounded Tip, Sharp	7¼ in	185 mm
65-1064	Curved, Rounded Tip, sharp	8 in	200 mm

Elevators (Periosteal)



26-4802

Adson Periosteal Elevator

CODE	DESCRIPTION	BLADE WIDTH		LENGTH	
26-4801	#1, Flat, Straight, Chisel Style	5/16 in	8 mm	6½ in	165 mm
26-4802	#2, Blunt, Light Curve	¼ in	6 mm	6½ in	165 mm
26-4803	#3, Sharp, Straight, Strong Curve	¼ in	6 mm	6½ in	165 mm
26-4804	#4, Sharp, Straight	¼ in	6 mm	6½ in	165 mm



Tip



65-1030

Adson Periosteal Elevator

CODE	DESCRIPTION	BLADE WIDTH		LENGTH	
65-1030	#1, Chisel Edge	5/16 in	8 mm	6½ in	165 mm
65-1031	#2, Curved, Blunt Edge	¼ in	6 mm	6½ in	165 mm
65-1032	#3, Curved, Semi-Sharp Edge	¼ in	6 mm	6½ in	165 mm
65-1033	#4, Straight, Semi-Sharp Edge	5/16 in	8 mm	6½ in	165 mm

Elevators (Periosteal)



Carroll Periosteal Elevator

CODE	DESCRIPTION	BLADE WIDTH	LENGTH
65-2549	Double-Ended	$\frac{1}{8}$ and $\frac{3}{8}$ in 3 and 10 mm	5 $\frac{1}{2}$ in 140 mm



26-5021

Cobb Elevator

CODE	BLADE WIDTH	LENGTH
26-5023	$\frac{1}{2}$ in 13 mm	14 in 355 mm
26-5020	$\frac{5}{8}$ in 16 mm	14 in 355 mm
26-5021	$\frac{3}{4}$ in 19 mm	14 in 355 mm
26-5022	1 in 25 mm	14 in 355 mm



Cottle Elevator

CODE	DESCRIPTION	LENGTH
26-2766	Double-Ended	8 $\frac{5}{8}$ in 219 mm

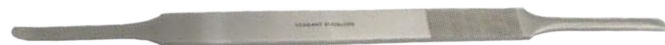

Cottle-McKenty Periosteal Elevator

CODE	DESCRIPTION	LENGTH
26-4226	Periosteal Elevator	8 $\frac{1}{2}$ in 215 mm

Elevators (Periosteal)



Tip



26-6201

Cushing Elevator

CODE	DESCRIPTION	LENGTH	
26-6201	15 mm Wide, Round Edge, Slightly Curved	7 1/8 in	180 mm
26-6202	15 mm Wide, Square Edge, Slightly Curved	7 1/8 in	180 mm



65-1047

Cushing "Little Joker" Periosteal Elevator

CODE	DESCRIPTION	BLADE WIDTH		LENGTH	
65-1047	Hollow Handle	1/4 in	6 mm	6 in	152 mm
26-6203	Solid Handle	1/4 in	6 mm	7 1/2 in	190 mm
65-1048	Solid Handle	1/4 in	6 mm	7 1/2 in	191 mm



65-1075

Cushing Periosteal Elevator

CODE	DESCRIPTION	BLADE WIDTH		LENGTH	
65-1075	Rounded Edge, Sharp, Wide	5/8 in	16 mm	7 1/4 in	185 mm
65-1076	Square Edge, Sharp, Wide	5/8 in	16 mm	7 1/4 in	185 mm



Cushing Periosteal Elevator

CODE	DESCRIPTION	BLADE WIDTH		LENGTH	
65-1050	Sharp, Narrow	1/4 in	6 mm	8 1/8 in	206 mm

Elevators (Periosteal)

Freer Elevator

Double-Ended, Sharp and Blunt Ends



55-7026

CODE	TIP	LENGTH	
55-7027	4.5 mm	7½ in	190 mm
55-7026	6.5 mm	7½ in	190 mm



65-1002

Hoehn Periosteal Elevator

CODE	DESCRIPTION	BLADE WIDTH		LENGTH	
65-1001	#1	5/16 in	8 mm	7 in	178 mm
65-1002	#2	5/8 in	16 mm	7¼ in	185 mm
65-1003	#1	¾ in	19 mm	7½ in	191 mm



Iowa University Periosteal Elevator

CODE	BLADE WIDTH	LENGTH	
65-1080	1¼ in 17 mm	7¼ in	185 mm



Joseph Periosteal Elevator

CODE	DESCRIPTION	BLADE WIDTH		LENGTH	
26-4404	Sharp, Light Curve	3/16 in	4 mm	6½ in	165 mm

Elevators (Periosteal)



Key Periosteal Elevator

65-2510

CODE	BLADE WIDTH	LENGTH
65-2510	¼ in 6 mm	7½ in 191 mm
65-2511	⅜ in 10 mm	7½ in 191 mm
65-2512	½ in 13 mm	7½ in 191 mm
65-2513	¾ in 19 mm	7½ in 191 mm
65-2514	1 in 25 mm	7½ in 191 mm



Key Periosteal Elevator

26-5606

CODE	DESCRIPTION	BLADE WIDTH	LENGTH
26-5604	Slight Curve	⅛ in 3 mm	7½ in 190 mm
26-5606	Slight Curve	¼ in 6 mm	7½ in 190 mm
26-5612	Slight Curve	½ in 13 mm	7½ in 190 mm
26-5620	Slight Curve	¾ in 19 mm	7½ in 190 mm
26-5625	Slight Curve	1 in 25 mm	8½ in 215 mm

Kleinert-Kutz Elevator & Dissector

CODE	DESCRIPTION	TIP	LENGTH
20-1788	Sharp, Double-Ended	2 mm and 3 mm	5 in 127 mm



26-1411

Lane Periosteal Elevator

CODE	DESCRIPTION	LENGTH
26-1411	6 mm Blunt	7¾ in 197 mm
26-1412	10 mm Blunt	7¾ in 197 mm

Elevators (Periosteal)



Langenbeck Periosteal Elevator

65-1116

CODE	DESCRIPTION	BLADE WIDTH		LENGTH	
65-1115	Narrow	¼ in	6 mm	8 ¼ in	210 mm
65-1116	Wide	1 ¼ in	27 mm	7 ½ in	191 mm



23-0279

Locke Elevator

CODE	DESCRIPTION	LENGTH	
23-0279	Narrow Blade	4 ½ in	115 mm
23-0290	Wide Blade	5 in	125 mm



Love-Adson Periosteal Elevator

CODE	DESCRIPTION	BLADE WIDTH		LENGTH	
65-1110	Semi-Sharp	¾ in	5 mm	6 ½ in	165 mm



26-4224

McKenty Periosteal Elevator

CODE	DESCRIPTION	TIP	LENGTH	
26-4224	Sharp, Light Curve	4 mm	6 in	150 mm
26-4225	Sharp, Light Curve	5 mm	6 in	150 mm

Elevators (Periosteal)



Periosteal Elevator

65-1056

Sharp

CODE	DESCRIPTION	TIP WIDTH	LENGTH
65-1056	#1	$\frac{3}{16}$ in 5 mm	8 in 203 mm
65-1057	#2	$\frac{1}{4}$ in 6 mm	8 in 203 mm
65-1058	#3	$\frac{5}{16}$ in 8 mm	8 in 203 mm
65-1059	#4	$\frac{15}{32}$ in 12 mm	8 in 203 mm



Tip



Periosteal Elevator

CODE	DESCRIPTION	TIP	LENGTH
26-6416	Double-Ended	6 mm	$7\frac{1}{4}$ in 185 mm



26-4452

Periosteal Elevator

Phenolic Handle, Sharp

CODE	DESCRIPTION	TIP	LENGTH
26-4450	Straight Edge	3 mm	$7\frac{1}{4}$ in 185 mm
26-4451	Straight Edge	4 mm	$7\frac{3}{4}$ in 197 mm
26-4452	Straight Edge	5 mm	$7\frac{1}{4}$ in 185 mm
26-4453	Round Edge	6 mm	$7\frac{1}{4}$ in 185 mm



Periosteal Elevator

26-4455

Phenolic Handle, Sharp

CODE	DESCRIPTION	LENGTH
26-4454	Straight Blade, 14 mm Oval Edge	$7\frac{3}{4}$ in 195 mm
26-4455	Curved Blade, 14 mm Oval Edge	$7\frac{3}{4}$ in 195 mm

Elevators (Periosteal)



Periosteal Elevator

Phenolic Handle, Sharp

CODE	DESCRIPTION	LENGTH
26-4457	Straight Blade, Straight Edge, 13 mm	7¼ in 185 mm
26-4458	Curved Blade, Round Edge 13 mm	7¾ in 197 mm



26-3751

Sayre Periosteal Elevator

Double-Ended, 5 mm and 9 mm

CODE	DESCRIPTION	LENGTH
26-3750	Sharp	6½ in 165 mm
26-3751	Blunt	6½ in 165 mm



Sedillot Periosteal Elevator

CODE	DESCRIPTION	BLADE WIDTH	LENGTH
26-4738	Periosteal Elevator, Sharp	1¼ in 17 mm	7 in 177 mm

Endoscopes (Arthroscopic)

Arthrolux Scope

CODE	DESCRIPTION	WORKING LENGTH
455-18300-SSI	0°, 4 mm	175 mm
455-19300-SSI	30°, 4 mm	175 mm
455-20300-SSI	70°, 4 mm	175 mm
455-29200-SSI	30° 2, 7 mm	180 mm

Extractors (Acetabular Component)

Acetabular Component Gripper

CODE	DESCRIPTION
12-006-000	Gripper



Extractors (Acetabular Prosthesis)

Acetabular Component Forceps

CODE	DESCRIPTION
14-001-000	Forceps



Extractors (Femoral Prosthesis)

Closed Looped Extractor

CODE	DESCRIPTION
12-029-000	



Femoral Extractor

CODE	DESCRIPTION
12-001-000	Slap Hammer



Extractors (Femoral Prosthesis)

Hip Stem Extractor

CODE	DESCRIPTION
12-031-000	Universal Modular



Hook Stem Extractor

CODE
12-030-000



Slap Hammer

CODE	DESCRIPTION
12-007-000	Small



Stem Adapter

CODE	DESCRIPTION
12-004-000	One Piece



Extractors (Prosthesis)

Extraction Screw

CODE
12-010-000



Extractors (Prosthesis)

Screw Extractor

CODE	DESCRIPTION
10-116-000	2.5 mm
10-130-000	3.5 mm



10-116-000

Extractors (Tap)

Conical Tap

CODE	DESCRIPTION
12-008-000	9 mm
12-009-000	11 mm

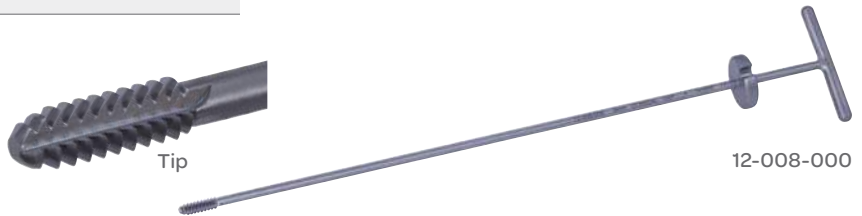

12-008-000

Files (Bone)

Bone File

Double-Ended

CODE	TIP	LENGTH
26-1350	5 mm and 7 mm	7¼ in 184 mm



Tip

Bone File

Single-Ended

CODE	TIP	LENGTH
26-1428	2-Sided, One Convex and One Flat	11 in 279 mm



Files (Bone)

Bone File

Single-Ended, Bayonet



CODE	TIP	LENGTH
26-1450	2-Sided, One Convex and One Flat	9½ in 241 mm

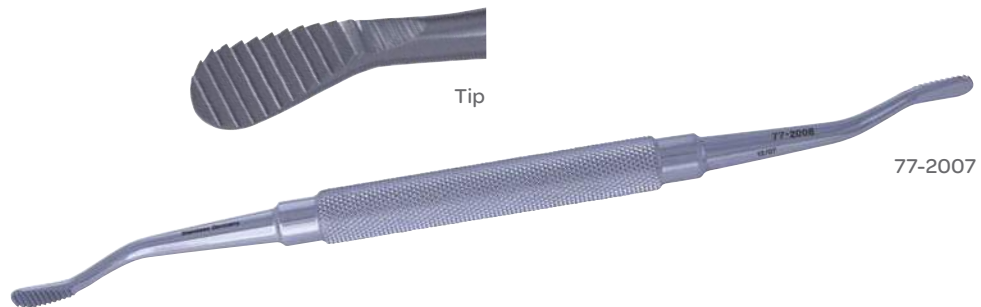

Miller Bone Files

CODE	TIP	LENGTH
77-2007	#10, Serrated, Double-Ended	5 mm Wide 7 in 178 mm
77-2008	#12, Double-Ended	5 and 7 mm 7 in 178 mm
77-2009	#12A, Serrated, Double-Ended	5 mm Wide 7 in 178 mm
77-2010	#12CA, Double-Ended with Cross Serrations	7 in 178 mm
77-2011	#33, Double-Ended with Plain Serrations	6 and 5 mm 7 in 178 mm
77-2002	#93, Angled with Serrations, Singled-Ended	2 mm Wide 9 in 229 mm

Forceps (Arthroscopic)

Grasper

CODE	DESCRIPTION	BITE WIDTH
1010304	Straight Tip, Alligator, Curved up 15°	3.5 mm
1010302	Straight Tip, Cup Curved up 15°	3.4 mm
1010305	Straight Tip, Alligator, Large	3.8 mm
1010303	Alligator, Straight	3.4 mm
1010301	Cupped Straight	3.4 mm
1040301	Loose Body	3.4 mm
1010306	Loose Body, Straight	3.4 mm



Forceps (Bone Cutting)

Bone Cutting Forceps

CODE	DESCRIPTION	LENGTH
33-0215	Straight	6 in 150 mm



Horsley Bone Cutting Forceps

Double-Action

CODE	DESCRIPTION	LENGTH
30-1298	Curved Shaft, Angular Jaw	10 ½ in 267 mm

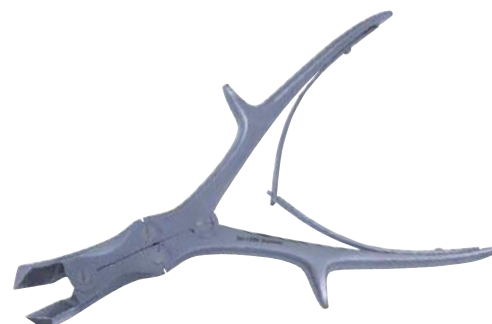

Forceps (Bone Cutting)

Liston Bone Cutting Forceps

CODE	DESCRIPTION	LENGTH
30-1310	Straight	5½ in 140 mm
33-2017	Straight	6¾ in 170 mm
33-2019	Straight	7½ in 190 mm
33-2022	Straight	8¾ in 220 mm
33-5115	Curved	6 in 150 mm



30-1310

Liston Bone Cutting Forceps

CODE	DESCRIPTION	LENGTH
33-2119	Angled	7½ in 190 mm



Liston-Key Bone Cutting Forceps

CODE	DESCRIPTION	LENGTH
33-7527	S-Shaped	10¾ in 270 mm

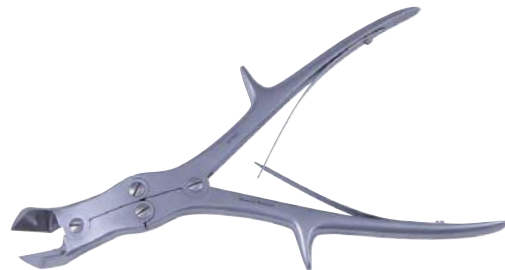

McIndoe Bone Cutting Forceps

CODE	DESCRIPTION	LENGTH
33-5917	Angled on Flat	7 in 175 mm



Forceps (Bone Cutting)

Ruskin Bone Cutting Forceps

CODE	DESCRIPTION	LENGTH
30-1290	Double-Action	7¼ in 185 mm



Ruskin-Rowland Bone Forceps

CODE	DESCRIPTION	LENGTH
33-5618	Straight	7¼ in 185 mm
33-5518	Angled	7⅛ in 180 mm
33-5718	Angled	7¼ in 185 mm



33-5618

Stille-Liston Bone Forceps

CODE	DESCRIPTION	LENGTH
30-1295	Double-Action	10½ in 267 mm
30-1296	Double-Action	10½ in 267 mm

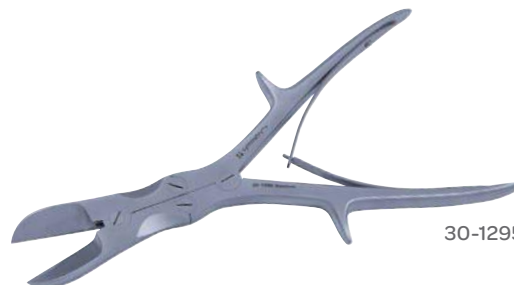

30-1295

Forceps (Bone Holding)

Bishop Bone Forceps

CODE	DESCRIPTION	LENGTH
35-6472	With Adjustable Jaw	9 in 230 mm
35-6473	With Adjustable Jaw	13 in 355 mm



35-6472

Forceps (Bone Holding)

Hey Groves Bone Holding Forceps

CODE	DESCRIPTION	LENGTH
35-7510	Speed Lock, with Teeth	11 ⁷ / ₈ in 300 mm



Kern Bone Holder Forceps

CODE	DESCRIPTION	LENGTH
35-3514	With Ratchet	5 ³ / ₄ in 145 mm
35-3523	With Ratchet	8 ¹ / ₂ in 215 mm



Lewin Bone Forceps

CODE	DESCRIPTION	LENGTH
35-1118	Slightly Curved, Serrated	7 ¹ / ₈ in 180 mm



Verbugge Bone Holding Forceps

CODE	DESCRIPTION	JAW	LENGTH
35-7517	With Short Ratchet	5 mm	7 in 175 mm
35-7525	With Long Ratchet	9.5 mm	10 in 250 mm



Forceps (Bone Holding)

Verbugge Bone Holding Forceps

CODE	LENGTH
35-7531	7½ in 190 mm



Forceps (Bone Reduction)

Bone Reduction Forceps

Curved

CODE	DESCRIPTION	LENGTH
35-1137	Pointed Tips	5 in 125 mm
35-1138	Pointed Tips, Serrated	5¼ in 135 mm



35-1137

Bone Reduction Forceps

Curved

CODE	DESCRIPTION	LENGTH
35-1145	Pointed Tips	7 in 178 mm



Bone Reduction Forceps

CODE	DESCRIPTION	LENGTH
35-1140	Curved, One Tip Pointed	6¾ in 170 mm

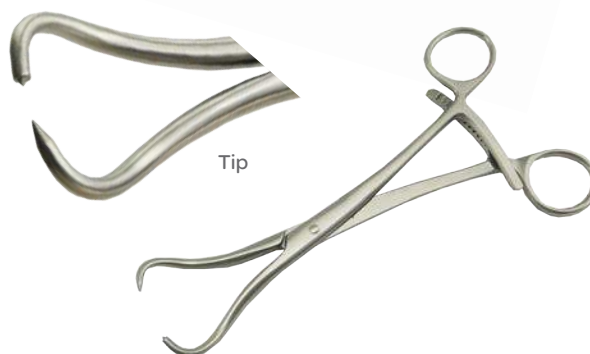

Forceps (Bone Reduction)

Bone Reduction Forceps

CODE	DESCRIPTION	LENGTH
35-1146	Curved	7 in 175 mm



Bone Reduction Forceps

CODE	DESCRIPTION	LENGTH
35-1148	Jaws Slightly Curved	5½ in 140 mm



Bone Reduction Forceps

CODE	DESCRIPTION	LENGTH
35-1149	Opens Jaws to 4 in, 2 in Ratchet	8 in 200 mm



Stagbeetle Bone Reduction Forceps

Curved

CODE	DESCRIPTION	LENGTH
35-1135	Pointed Tips	4¾ in 120 mm



Forceps (Bone Reposition)

Bone Reposition Forceps

CODE	DESCRIPTION	LENGTH
35-1113	Curved	5 1/8 in 130 mm



Forceps (Ligamentum Flavum)

Preston Ligamentum Flavum Forceps

CODE	DESCRIPTION	LENGTH
35-2165	Serrated, 1 x 2 Teeth	7 1/4 in 185 mm



Forceps (Malleolar)

Malleolar Forceps

CODE	DESCRIPTION	LENGTH
35-1134	1 x 1 Sharp Points	8 1/4 in 210 mm

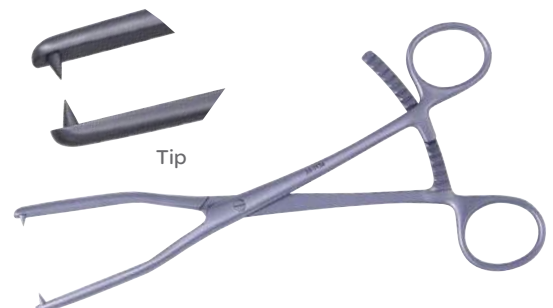

Forceps (Meniscus)

Cartilage & Meniscus Forceps

CODE	DESCRIPTION
35-2021	3 x 4 Teeth



Forceps (Pelvic)

Pelvic Reduction Forceps

CODE	LENGTH
35-1172	9 $\frac{7}{8}$ in 250 mm

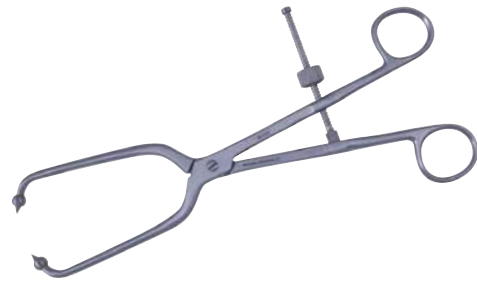

Pelvic Reduction Forceps

CODE	LENGTH
35-1173	16 in 405 mm



Forceps (Phalangeal)

Locke Phalangeal Forceps

CODE	DESCRIPTION	LENGTH
35-1111	Serrated, 1 x 2 Teeth	6 in 152 mm



Forceps (Screw Removal)

Forceps

CODE	DESCRIPTION
14-039-000	Screw Holding



Forceps (Sesamoidectomy)

Sesamoidectomy Clamp Forceps

CODE	DESCRIPTION	LENGTH
35-1120	Slightly Curved	6½ in 165 mm



Forceps (Synovectomy)

Synovectomy Forceps

CODE	DESCRIPTION	LENGTH
30-7617	With Rongeur Jaws, Ring Handle	5 in 125 mm



Forceps (Tendon)

Brand Tendon Forceps

CODE	DESCRIPTION	LENGTH	
78-1115	Curved Jaw, 1 x 2 Teeth	6 in	150 mm
78-1119	Curved Jaw, 1 x 2 Teeth	7½ in	190 mm



78-1115

Gouges (Acetabular)

Acetabular Gouge

CODE	TIP	WIDTH
10-057-000	48 mm	½ in
10-058-000	52 mm	½ in
10-059-000	56 mm	½ in



10-057-00

Gouges (Arthroscopic)

Gouge

CODE	DESCRIPTION	WORKING DIAMETER	WORKING LENGTH
1010901	Straight	4.6 mm	115 mm
1010902	Compound Curve	4.6 mm	115 mm

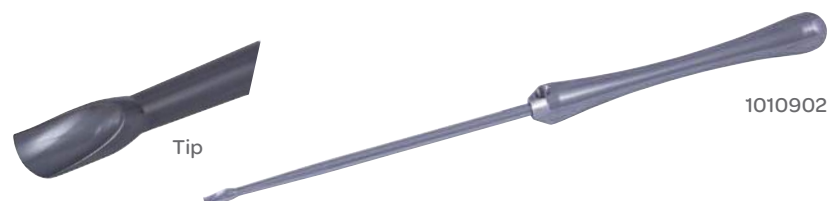

1010902

Gouges (Bone)

Alexander Gouge

CODE	TIP	LENGTH
28-2804	4 mm	7 in 178 mm
28-2806	6 mm	7 in 178 mm
28-2808	8 mm	7 in 178 mm
28-2814	14 mm	7 in 178 mm



28-2804

Bishop Gouge

CODE	TIP	LENGTH
27-6063	3 mm	6 in 150 mm



Tip

Bone Gouge

CODE	DESCRIPTION	TIP WIDTH	LENGTH
32-2000	Straight	1/4 in 6 mm	11 in 279 mm
32-2001	Straight	3/8 in 10 mm	11 in 279 mm
32-2002	Straight	1/2 in 13 mm	11 in 279 mm
32-2003	Straight	5/8 in 16 mm	11 in 279 mm
32-2004	Straight	3/4 in 19 mm	11 in 279 mm
32-2005	Straight	1 in 25 mm	11 in 279 mm
32-2006	Straight	1 1/4 in 32 mm	11 in 279 mm
32-2010	Curved	1/4 in 6 mm	11 in 279 mm
32-2011	Curved	3/8 in 10 mm	11 in 279 mm
32-2012	Curved	1/2 in 13 mm	11 in 279 mm
32-2013	Curved	5/8 in 16 mm	11 in 279 mm
32-2014	Curved	3/4 in 19 mm	11 in 279 mm
32-2015	Curved	1 in 25 mm	11 in 279 mm
32-2016	Curved	1 1/4 in 32 mm	11 in 279 mm



32-2001

Gouges (Bone)

Gouge

CODE	DESCRIPTION	TIP	LENGTH	
43-4077	Pointed Tip	$\frac{1}{16}$ in 2 mm	5 in	125 mm



Hibbs Gouge

CODE	DESCRIPTION	TIP WIDTH		LENGTH	
28-5206	Straight	$\frac{1}{4}$ in	6 mm	$9\frac{1}{2}$ in	241 mm
28-5210	Straight	$\frac{3}{8}$ in	10 mm	$9\frac{1}{2}$ in	241 mm
28-5212	Straight	$\frac{1}{2}$ in	13 mm	$9\frac{1}{2}$ in	241 mm
28-5216	Straight	$\frac{5}{8}$ in	16 mm	$9\frac{1}{2}$ in	241 mm
28-5220	Straight	$\frac{3}{4}$ in	19 mm	$9\frac{1}{2}$ in	241 mm
28-5225	Straight	1 in	25 mm	$9\frac{1}{2}$ in	241 mm
28-5240	Straight	$1\frac{1}{2}$ in	38 mm	$9\frac{1}{2}$ in	241 mm
28-5256	Curved	$\frac{1}{4}$ in	6 mm	$9\frac{1}{2}$ in	241 mm
28-5260	Curved	$\frac{3}{8}$ in	10 mm	$9\frac{1}{2}$ in	241 mm
28-5262	Curved	$\frac{1}{2}$ in	13 mm	$9\frac{1}{2}$ in	241 mm
28-5266	Curved	$\frac{5}{8}$ in	16 mm	$9\frac{1}{2}$ in	241 mm
28-5270	Curved	$\frac{3}{4}$ in	19 mm	$9\frac{1}{2}$ in	241 mm
28-5275	Curved	1 in	25 mm	$9\frac{1}{2}$ in	241 mm
28-5280	Curved	$1\frac{1}{8}$ in	30 mm	$9\frac{1}{2}$ in	241 mm
28-5290	Curved	$1\frac{1}{2}$ in	38 mm	$9\frac{1}{2}$ in	241 mm



28-5210

Lexer Gouge

CODE	DESCRIPTION	TIP	LENGTH	
28-5301		$\frac{3}{16}$ in 5 mm	7 in	175 mm



Gouges (Bone)

Smith-Peterson Bone Gouge

CODE	DESCRIPTION	TIP WIDTH	LENGTH
32-2540	Straight	¼ in 6 mm	8 in 203 mm
32-2541	Straight	⅜ in 10 mm	8 in 203 mm
32-2542	Straight	½ in 12 mm	8 in 203 mm
32-2543	Straight	⅝ in 16 mm	8 in 203 mm
32-2544	Straight	¾ in 20 mm	8 in 203 mm
32-2545	Straight	1 in 25 mm	8 in 203 mm
28-7230	Straight	1⅛ in 30 mm	8 in 200 mm
32-2546	Straight	1¼ in 32 mm	8 in 203 mm
32-2550	Curved	¼ in 6 mm	8 in 203 mm
32-2551	Curved	⅜ in 10 mm	8 in 203 mm
32-2552	Curved	½ in 12 mm	8 in 203 mm
32-2553	Curved	⅝ in 16 mm	8 in 203 mm
32-2554	Curved	¾ in 20 mm	8 in 203 mm
32-2555	Curved	1 in 25 mm	8 in 203 mm
28-7280	Curved	1⅛ in 30 mm	8 in 200 mm
32-2556	Curved	1¼ in 32 mm	8 in 203 mm



32-2501

Stille Gouge

CODE	DESCRIPTION	TIP	LENGTH
28-4512	Straight	½ in 12 mm	8 in 203 mm
28-4515	Straight	⅞ in 15 mm	8 in 203 mm
28-4525	Straight	1 in 25 mm	8 in 203 mm



28-4512

Swan Neck Gouge

CODE	LENGTH
28-6255	9 in 229 mm



Graspers (Arthroscopic)

Joint Grasper

Straight

CODE	DESCRIPTION
1030301	Small



Suture Grasper

CODE
1020304

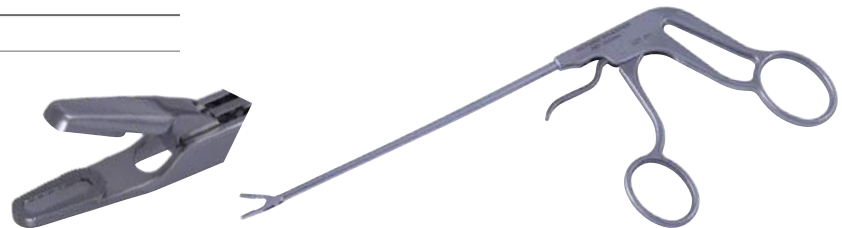

Handles (Impaction)

Impaction Handle

CODE	DESCRIPTION
10-148-000	Modular Cement

* For use with Tibial Perforator on O/A-3



Handles (Quick-Coupling)

Quick-Coupling Handle

Two Per Set

CODE	DESCRIPTION
10-020-000	For Flexible Osteotome Blades on page O/A-63



Handles (Ratcheting)

Black Mini Ratcheting Handle

CODE	DESCRIPTION
15-043-101	Square Drive, 1/4 in



Hooks

Hook

CODE	DESCRIPTION	LENGTH
77-1505	Sharp	6 in 151 mm



Crochet Hook

CODE
1021001

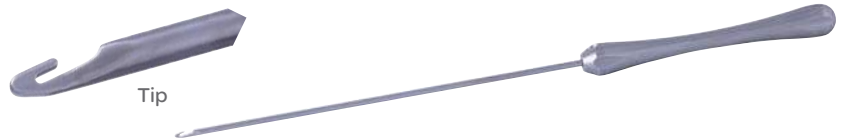

Hooks (Bone)

Bone Hook

CODE	DESCRIPTION	HOOK DIAMETER	LENGTH
32-3422	Large-Sharp	60 mm	8 1/2 in 216 mm
32-3423	Heavy Duty-Sharp	19 mm	9 in 229 mm
32-3425	Heavy Duty-Sharp	30 mm	9 in 229 mm
32-3424	Heavy Duty-Blunt	19 mm	9 in 229 mm



Hooks (Bone)

Bone Hook

Grip Handle

CODE	DESCRIPTION	TIP	LENGTH
77-1010	Sharp	10 mm	7½ in 191 mm
77-1020	Sharp	20 mm	7½ in 191 mm
77-1028	Sharp	13 mm	9 in 229 mm
77-1029	Sharp	22 mm	9 in 229 mm
77-1030	Sharp	30 mm	9 in 229 mm



77-1010

Bone Hook

T-Handle

CODE	DESCRIPTION	LENGTH
77-1032	Sharp, Stainless Steel	7 in 178 mm
77-1035	Sharp	11 in 279 mm



77-1032

Volkman Bone Hook

CODE	DESCRIPTION	LENGTH
77-1040	Sharp	8 in 203 mm
77-1044	Sharp	9 in 229 mm
77-1041	Blunt	9 in 229 mm



77-1040

Hooks (Cement Removal)

Crochet Hook

CODE
10-056-000



Impactors (Bone Graft)

Bone Graft Impactor & Holder

CODE	DIMENSIONS
28-1003	8 ¾ in 222 mm



Cloward Graft Impactor

Double-Ended

CODE	END DIAMETERS	LENGTH
77-2014	7/16 in 11 mm 9/16 in 14 mm	8 ¼ in 210 mm



Graft Impactor

Double-Ended

CODE	END DIAMETER	LENGTH
28-1000	7/16 in 11 mm 9/16 in 14 mm	8 ¾ in 222 mm



MultiPak Bone Impactor

CODE	DESCRIPTION	DIMENSIONS
52-5280	Replaceable Nylon Cap	6 ½ in 165 mm



Impactors (Prosthesis)

Component Impactor

CODE
10-016-000



Kits (Calcar Driver)

Complete 1.5 in Calcar Driver Set

Complete set included one modular calcar planer, one disposable calcar blade and one calcar driver wrench

CODE	DESCRIPTION
30-041-000	TR-Shank End



Kits (FlashPak® Refurbish)

FlashPak® Refurbish Kit

CODE	DESCRIPTION
9000-09	9020-09(2), 9020-11(1)

Kits (Flexible Osteotome)

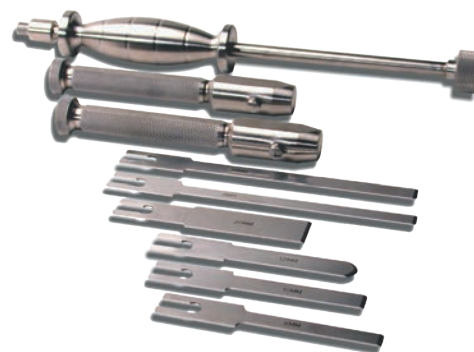

Flexible Osteotome System Complete

CODE	DESCRIPTION	QTY
30-005-000	Flexible Osteotome System Complete Includes the Following:	
10-020-000	Quick-Coupling Handle for Flex Osteotomes	2
12-007-000	Small Slap Hammer	1
11-002-000	Thin Osteotome Blade, 8 mm x 3 in	1
11-003-000	Thin Osteotome Blade, 10 mm x 3 in	1
11-004-000	Thin Osteotome Blade, 12 mm x 3 in	1
11-005-000	Thin Osteotome Blade, 20 mm x 3 in	1
11-006-000	Thin Osteotome Blade, Curved End, 12 mm	1
11-007-000	Thin Osteotome Blade, Curved End, 20 mm	1
11-008-000	Thin Osteotome Blade, 8 mm x 5 in	1
11-009-000	Thin Osteotome Blade, 10 mm x 5 in	1
25-005-000	Metal Case	1

Kits (Hip Revision)

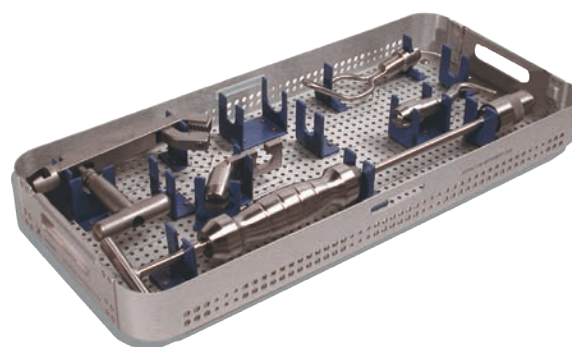

Complete Extractor Tray

CODE	DESCRIPTION	QTY
30-035-000	Complete Extractor Tray Includes the Following:	
12-001-000	Femoral Extractor Slaphammer	1
12-031-000	Universal Modular Hip Stem Extractor	1
12-004-000	One-Piece Stem Adapter	1
12-029-000	Closed Loop Extractor	1
12-030-000	Hook Stem Extractor	1
25-022-000	Metal Case	1

Kits (Hip Retractor)



30-034-000

Complete Hip Retractor System

CODE	DESCRIPTION	QTY
30-034-000	Set Includes the Following:	
13-023-000	Hip Retractor, 25 mm Blade	1
13-024-000	Hip Retractor, Blunt Tip	1
13-025-000	Offset Retractor, 32 mm Blade	1
13-026-000	Long Hohmann	1
13-027-000	Long Hohmann, Curved, Short Blade	1
13-028-000	Long Hohmann, Curved, Long Blade	1
13-029-000	Long Hohmann, Narrow	1
13-030-000	Small Hohmann Part	1
13-031-000	Femoral Elevator	1
25-028-000	Hybrid Case	1

Kits (Karlin™ Curved Stiletto Osteotome)



46-3050

Karlin™ Curved Stiletto Osteotome Set

CODE	DESCRIPTION	LENGTH
46-3050	Karlin™ Curved Stiletto Osteotome Set With Case, Includes the Following Items:	
46-3051	Curved	¼ in 6 mm 8½ in 216 mm
46-3052	Curved	⅜ in 10 mm 8½ in 216 mm
46-3053	Curved	½ in 13 mm 8½ in 216 mm
46-3054	Curved	⅝ in 16 mm 8½ in 216 mm
46-3055	Curved	¾ in 19 mm 8½ in 216 mm
46-3056	Case For curved stiletto osteotome	

Kits (Knee Retractor)

Knee Retractor System

Includes Hohmann, Collateral, Patellar, Superior, Condylar and Soft Tissue Retractors

CODE	DESCRIPTION
30-032-000	Minimally Invasive



Kits (MultiPak Metal Carrying Handle)

MultiPak Metal Carrying Handle Kit

CODE	DESCRIPTION
5130	For 5000-01, 5010-03 and 5022-03

Our Values

- We are passionate about our mission to improve patient outcomes.
- We are dedicated to delivering exceptional quality and service.
- We are collaborative with our customers, responding directly to clinician and provider needs with new innovations that help deliver superior patient care.

Customer Focus

Whether you're a purchasing agent, nurse or surgeon, our goal is to develop a collaborative, service-oriented relationship that will allow us to meet all of your needs. Clinically trained as professional instrument specialists, our sales representatives are available locally to assist you with any instrument-related needs – including product checkups.

Kits (Screw Removal)

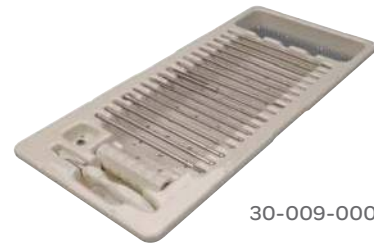

30-009-000

Complete Screw Removal System

CODE	DESCRIPTION
30-009-000	System Includes One (1) Each of the Following:
10-128-000	1.5 mm Screw Extractor
10-116-000	2.5 mm Screw Extractor
10-130-000	3.5 mm Screw Extractor
10-117-000	1.5 mm Hex Driver
10-114-000	2.5 mm Hex Driver
10-115-000	3.5 mm Hex Driver
10-132-000	4.0 mm Hex Driver
10-133-000	5.0 mm Hex Driver
10-119-000	Small Cruciform Screwdriver
10-141-000	Mini Cruciform Screwdriver
10-120-000	Straight Screwdriver
10-127-000	Universal Extractor
10-127-001	Large Extraction Bolt Body
10-127-003	Small Extraction Bolt
10-129-000	Fracture Pick
10-121-000	2.2 mm Trephine
10-122-000	3.2 mm Trephine
10-123-000	4.2 mm Trephine
10-125-000	7.2 mm Trephine
10-113-000	Universal Driver Handle
10-121-010	Radel® R Case

Kits (Stiletto Chisel)



46-3080

Karlin™ Curved Stiletto Chisel Set with Case

CODE	DESCRIPTION	TIP SIZE
46-3080	Set Includes One (1) Each of the Following:	
46-3081	Chisel Curved	¼ in 6 mm
46-3082	Chisel Curved	⅜ in 10 mm
46-3083	Chisel Curved	½ in 13 mm
46-3084	Chisel Curved	⅝ in 16 mm
46-3085	Chisel Curved	¾ in 19 mm
46-3086	Case For Straight Stiletto Chisel Set	

Kits (Stiletto Chisel)

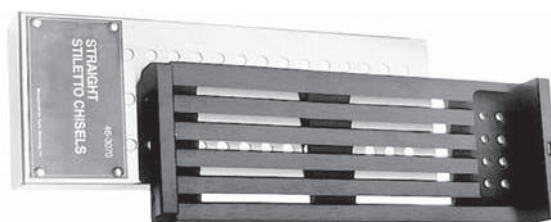

Karlin™ Straight Stiletto Chisel Set With Case

46-3070

CODE	DESCRIPTION	TIP SIZE
46-3070	Set Includes One (1) Each of the Following:	
46-3071	Chisel Straight	¼ in 6 mm
46-3072	Chisel Straight	⅜ in 10 mm
46-3073	Chisel Straight	½ in 13 mm
46-3074	Chisel Straight	⅝ in 16 mm
46-3075	Chisel Straight	¾ in 19 mm
46-3076	Case For Straight Stiletto Chisel Set	

Kits (Tibial Impaction)



30-026-000

Complete Tibial Impaction System

CODE	DESCRIPTION
30-026-000	Set Includes One (1) Each of the Following:
	Small Tibial Perforator
	Medium Tibial Perforator
	Large Tibial Perforator
	Small Cement Well
	Medium Cement Well
	Large Cement Well
	Small Compression Base
	Medium Compression Base
	Large Compression Base
	Modular Cement Impaction Handle
	Small Slap Hammer
	Radel® R Case

Kits (Trepine)

Complete Trepine Tray

CODE	DESCRIPTION
30-014-000	Set Includes One (1) Each of the Following:
12-028-000	Slap Hammer Shaft
10-023-000	Quick Connect T-Handle
10-062-000	T-Bar Stem Extractor
10-075-000	Wrench
10-063-000	Trepine 11 mm ID x 8 in
10-064-000	Trepine 12 mm ID x 8 in
10-065-000	Trepine 13 mm ID x 8 in
10-066-000	Trepine 14 mm ID x 8 in
10-067-000	Trepine 15 mm ID x 8 in
10-068-000	Trepine 16 mm ID x 8 in
10-069-000	Trepine 17 mm ID x 8 in
10-070-000	Trepine 18 mm ID x 8 in
10-071-000	Trepine 19 mm ID x 8 in
10-072-000	Trepine 20 mm ID x 8 in
10-073-000	Trepine 21 mm ID x 8 in
10-074-000	Trepine 22 mm ID x 8 in
10-099-000	Trepine 23 mm ID x 8 in
10-101-000	Trepine 24 mm ID x 8 in
25-023-000	Metal Case

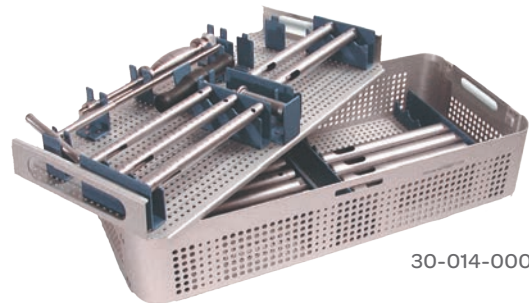

30-014-000

Kits (Universal Shoulder Arthroplasty)

Complete Universal Arthroplasty System

CODE	DESCRIPTION
30-024-000	Set Includes One (1) Each of the Following:
13-002-000	Modified Bankhart Retractor
13-003-000	Deltoid Retractor
13-004-000	Conjoined Tendon Retractor
13-005-000	Humeral Head Dislocator
13-006-000	Humeral Retractor
13-047-000	Hohmann Retractor
25-019-000	Radel® R Case Part



Knives (Arthroscopic)

Knife

Straight

CODE	DESCRIPTION	WORKING DIAMETER	WORKING LENGTH
1010602	Banana, Serrated	5 mm	114 mm
1010601	Hook	5 mm	112 mm
1010603	Meniscotome, Y-Shaped	5 mm	111 mm

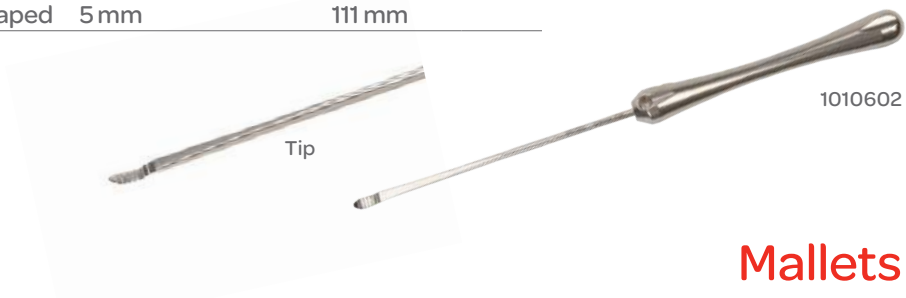

Mallets

Collin Lucae Bone Mallet

CODE	HEAD	WEIGHT	LENGTH
27-0422	Solid, 1¼ in	7½ oz 212 g	8 in 200 mm



Gerzog Mallet

Lead-Filled Head

CODE	HEAD	WEIGHT	LENGTH
27-0840	1 in 25 mm	10 oz 283 g	7 in 178 mm



Hajek Bone Mallet

Solid

CODE	HEAD	WEIGHT	LENGTH
27-0420	1 in 25 mm	6½ oz 184 g	8¼ in 210 mm



Mallets

Heath Heavyweight Mallet

CODE	HEAD	WEIGHT	LENGTH
27-0880	1½ in 38 mm	2 lb 907 g	7½ in 191 mm

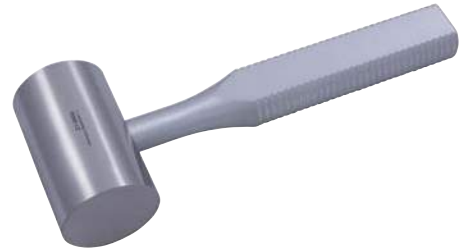

Heath Mallet

CODE	HEAD	WEIGHT	LENGTH
32-3330	2½ x 1½ in 64 x 38 mm	2 lb 907 g	7¼ in 184 mm

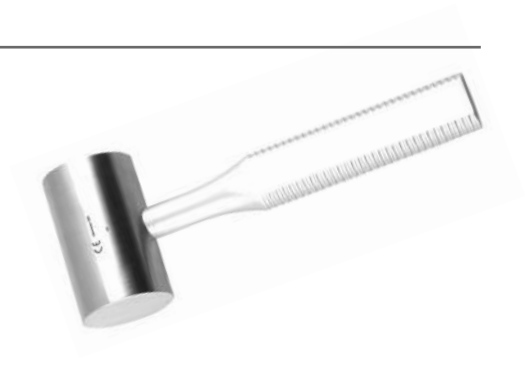

Hibbs Mallet

Solid Brass Head

CODE	HEAD	WEIGHT	LENGTH
88-2520	1½ in 38 mm	12 oz 340 g	8 in 203 mm



Mallets

Karlin™ Mallet

CODE	HEAD	WEIGHT	DIMENSIONS
46-3179	Small 1 in 25 mm	7.1 oz 200 g	9½ in 241 mm
46-3146	Large 1¼ in 32 mm	12 oz 340 g	9¾ in 247 mm



46-3146

Kirk Mallet

Bronze Head

CODE	HEAD	WEIGHT	LENGTH
27-0870	1½ in 38 mm	1lb, 7 oz 652 g	7½ in 191 mm



Mallet

CODE	DESCRIPTION	LENGTH
63-0206	One Side Nylon Cap	7½ in 191 mm
63-0207	Replacement Nylon Caps For 63-0205 & 63-0206, Pack of 2	

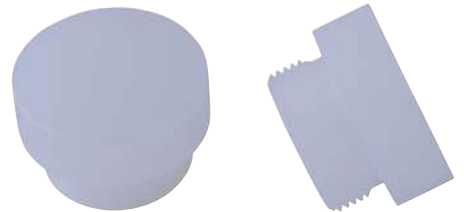

Mallet

CODE	DESCRIPTION	LENGTH
63-0205	With Nylon Replaceable Caps	7½ in 191 mm

Mallets

Mallet

CODE	DESCRIPTION	LENGTH
63-0200	Small, Copper	6½ in 165 mm

Mallet

CODE	DESCRIPTION	WEIGHT	LENGTH
27-0213	Small	5 oz 141 g	6½ in 165 mm

Mallet

CODE	HEAD	WEIGHT	LENGTH
27-0400	1¾ in 35 mm	1 lb 453 g	7¼ in 184 mm
27-0401	1½ in 38 mm	2 lb 907 g	7¾ in 195 mm



27-0400

Mead Mallet

CODE	WEIGHT	LENGTH
27-0630	11 oz 340 g	7½ in 191 mm

Mallets

Orthopedic Mallet

CODE	HEAD	WEIGHT	LENGTH
27-0866	1½ in 38 mm	1lb 453 g	10¾ in 273 mm
27-0899	1⅞ in 48 mm	3lb 1360 g	10¾ in 273 mm



27-0866

Slotted Mallet

CODE	DESCRIPTION
10-102-000	Delrin Cap



Small Mallet

Solid Brass Head

CODE	HEAD	WEIGHT	LENGTH
88-2500	1½ in 38 mm	15 oz 420 g	7 in 178 mm



Wagner Mallet

CODE	DIMENSIONS
63-0208	9¼ in 235 mm

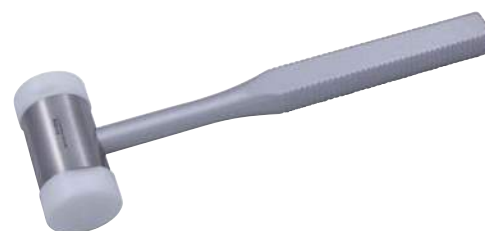

Mallets

Wagner Mallet Replacement Caps

For Use with 63-0208

CODE	DESCRIPTION
63-0208C	Set of 2



Manipulators (Arthroscopic)

Suture Manipulator

CODE
1020303



Osteotomes

Cobb Osteotome

CODE	DESCRIPTION	WIDTH	LENGTH
28-7020	Straight	¼ in 6 mm	11 in 279 mm
28-7021	Straight	⅜ in 10 mm	11 in 279 mm
28-7022	Straight	½ in 13 mm	11 in 279 mm
28-7023	Straight	⅝ in 16 mm	11 in 279 mm
28-7024	Straight	¾ in 19 mm	11 in 279 mm
28-7025	Straight	1 in 25 mm	11 in 279 mm
28-7028	Curved	⅜ in 10 mm	11 in 279 mm
28-7029	Curved	½ in 13 mm	11 in 279 mm
28-7030	Curved	⅝ in 16 mm	11 in 279 mm
28-7031	Curved	¾ in 19 mm	11 in 279 mm
28-7032	Curved	1 in 25 mm	11 in 279 mm
28-7033	Curved	1¼ in 32 mm	11 in 279 mm



Osteotomes

Flexible Osteotome Blade

See page O/A-46 for Quick-Coupling Handle

CODE	DESCRIPTION	BLADE WIDTH	LENGTH
11-002-000	Thin Osteotome Blade	$\frac{1}{3}$ in 8 mm	3 in 76 mm
11-003-000	Thin Osteotome Blade	$\frac{3}{8}$ in 10 mm	3 in 76 mm
11-004-000	Thin Osteotome Blade	$\frac{1}{2}$ in 13 mm	3 in 76 mm
11-005-000	Thin Osteotome Blade	$\frac{13}{16}$ in 20 mm	3 in 76 mm
11-008-000	Thin Osteotome Blade	$\frac{3}{8}$ in 8 mm	5 in 127 mm
11-009-000	Thin Osteotome Blade	$\frac{3}{8}$ in 10 mm	5 in 127 mm
11-031-000	Flexible	$\frac{1}{3}$ in 8 mm	5 in 127 mm
11-032-000	Flexible	$\frac{3}{8}$ in 10 mm	5 in 127 mm
11-030-000	Flexible	$\frac{3}{4}$ in 19 mm	5 in 127 mm
11-006-000	Curved End	$\frac{1}{2}$ in 13 mm	5 in 127 mm
11-007-000	Curved End	$\frac{3}{4}$ in 20 mm	5 in 127 mm
11-020-000	Radial	$\frac{1}{2}$ in 13 mm	5 in 127 mm



Flexible Osteotome Blade

CODE	DESCRIPTION	BLADE WIDTH	LENGTH
11-033-000	Radial	$\frac{3}{8}$ in 10 mm	5 in 127 mm
11-029-000	Radial	$\frac{7}{16}$ in 12 mm	5 in 127 mm
11-034-000	Radial	$\frac{1}{2}$ in 13 mm	5 in 127 mm
11-021-000	Radial	$\frac{5}{8}$ in 16 mm	5 in 127 mm
11-022-000	Radial	$\frac{3}{4}$ in 19 mm	5 in 127 mm

Osteotomes



28-5156

Hibbs Osteotome

CODE	DESCRIPTION	WIDTH	LENGTH
28-5106	Straight	¼ in 6 mm	9½ in 241 mm
28-5110	Straight	⅜ in 10 mm	9½ in 241 mm
28-5112	Straight	½ in 13 mm	9½ in 241 mm
28-5116	Straight	⅝ in 16 mm	9½ in 241 mm
28-5120	Straight	¾ in 19 mm	9½ in 241 mm
28-5122	Straight	⅞ in 22 mm	9½ in 241 mm
28-5125	Straight	1 in 25 mm	9½ in 241 mm
28-5130	Straight	1⅛ in 29 mm	9½ in 241 mm
28-5132	Straight	1¼ in 32 mm	9½ in 241 mm
28-5140	Straight	1½ in 38 mm	9½ in 241 mm
28-5156	Curved	¼ in 6 mm	9½ in 241 mm
28-5160	Curved	⅜ in 10 mm	9½ in 241 mm
28-5162	Curved	½ in 13 mm	9½ in 241 mm
28-5166	Curved	⅝ in 16 mm	9½ in 241 mm
28-5170	Curved	¾ in 19 mm	9½ in 241 mm
28-5172	Curved	⅞ in 22 mm	9½ in 241 mm
28-5175	Curved	1 in 25 mm	9½ in 241 mm
28-5180	Curved	1⅛ in 29 mm	9½ in 241 mm
28-5182	Curved	1¼ in 32 mm	9½ in 241 mm
28-5190	Curved	1½ in 38 mm	9½ in 241 mm



32-3438

Hoke Osteotome

CODE	DESCRIPTION	BLADE WIDTH	LENGTH
32-3439	Straight	0.3 mm	6 in 152 mm
32-3435	Straight	0.6 mm	6 in 152 mm
32-3436	Straight	1 mm	6 in 152 mm
32-3437	Straight	1.3 mm	6 in 152 mm
32-3438	Straight	1.6 mm	6 in 152 mm
32-3430	Curved	0.3 mm	6 in 152 mm
32-3431	Curved	0.6 mm	6 in 152 mm
32-3433	Curved	1 mm	6 in 152 mm
32-3432	Curved	1.3 mm	6 in 152 mm
32-3434	Curved	1.6 mm	6 in 152 mm

Osteotomes



28-4953

Hoke Osteotome

CODE	DESCRIPTION	BLADE WIDTH		LENGTH	
28-4903	Straight	1/8 in	3 mm	5 1/2 in	140 mm
28-4904	Straight	3/16 in	5 mm	5 1/2 in	140 mm
28-4906	Straight	1/4 in	6 mm	5 1/2 in	140 mm
28-4908	Straight	5/16 in	8 mm	5 1/2 in	140 mm
28-4910	Straight	3/8 in	10 mm	5 1/2 in	140 mm
28-4912	Straight	1/2 in	13 mm	5 1/2 in	140 mm
28-4953	Curved	1/8 in	3 mm	5 1/2 in	140 mm
28-4954	Curved	3/16 in	5 mm	5 1/2 in	140 mm
28-4956	Curved	1/4 in	6 mm	5 1/2 in	140 mm
28-4958	Curved	5/16 in	8 mm	5 1/2 in	140 mm
28-4960	Curved	3/8 in	10 mm	5 1/2 in	140 mm
28-4962	Curved	1/2 in	13 mm	5 1/2 in	140 mm



27-5524

Lambotte Osteotome

CODE	DESCRIPTION	CALIBRATION LINES		LENGTH	
27-5502	Straight	1/16 in	2 mm	7 1/4 in	185 mm
27-5504	Straight	1/8 in	4 mm	7 1/4 in	185 mm
27-5505	Straight	3/16 in	5 mm	7 1/4 in	185 mm
27-5506	Straight	1/4 in	6 mm	7 1/4 in	185 mm
27-5508	Straight	5/16 in	8 mm	7 1/4 in	185 mm
27-5510	Straight	3/8 in	10 mm	7 1/4 in	185 mm
27-5512	Straight	7/16 in	12 mm	7 1/4 in	185 mm
27-5516	Straight	5/8 in	16 mm	7 1/4 in	185 mm
27-5519	Straight	3/4 in	19 mm	7 1/4 in	185 mm
27-5522	Straight	7/8 in	22 mm	7 1/4 in	185 mm
27-5524	Curved	1/8 in	4 mm	7 1/4 in	185 mm
27-5526	Curved	1/4 in	6 mm	7 1/4 in	185 mm

Osteotomes



28-9412

Lambotte Osteotome

Without Calibration Lines

CODE	DESCRIPTION	BLADE WIDTH	LENGTH
28-9406	Straight	$\frac{1}{4}$ in 6 mm	9 in 228 mm
28-9412	Straight	$\frac{1}{2}$ in 13 mm	9 in 228 mm
28-9420	Straight	$\frac{3}{4}$ in 19 mm	9 in 228 mm
28-9430	Straight	$1\frac{1}{4}$ in 32 mm	9 in 228 mm
28-9440	Straight	$1\frac{1}{2}$ in 38 mm	9 in 228 mm



27-5702

Mini-Lambotte Osteotome

Swiss Pattern

CODE	DESCRIPTION	BLADE WIDTH	LENGTH
27-5702	Straight	$\frac{1}{16}$ in 2 mm	$5\frac{1}{8}$ in 130 mm
27-5704	Straight	$\frac{1}{8}$ in 4 mm	$5\frac{1}{8}$ in 130 mm
27-5706	Straight	$\frac{1}{4}$ in 6 mm	$5\frac{1}{8}$ in 130 mm
27-5708	Straight	$\frac{1}{3}$ in 8 mm	$5\frac{1}{8}$ in 130 mm
27-5710	Straight	$\frac{3}{8}$ in 10 mm	$5\frac{1}{8}$ in 130 mm
27-5712	Straight	$\frac{7}{16}$ in 12 mm	$5\frac{1}{8}$ in 130 mm
27-5714	Straight	$\frac{9}{16}$ in 14 mm	$5\frac{1}{8}$ in 130 mm
27-5715	Straight	$\frac{5}{8}$ in 15 mm	$5\frac{1}{8}$ in 130 mm
27-5718	Straight	$1\frac{1}{16}$ in 18 mm	$5\frac{1}{8}$ in 130 mm
27-5719	Straight	$\frac{3}{4}$ in 19 mm	$5\frac{1}{8}$ in 130 mm
27-5720	Straight	$1\frac{3}{16}$ in 20 mm	$5\frac{1}{8}$ in 130 mm

Osteotomes

Osteotome

CODE	DESCRIPTION	BLADE WIDTH	LENGTH
28-4410	Straight	3/8 in 10 mm	8 in 200 mm
28-4414	Straight	9/16 in 14 mm	8 in 200 mm
28-4418	Straight	3/4 in 18 mm	8 in 200 mm
28-4422	Straight	7/8 in 22 mm	8 in 200 mm



28-4404

Osteotome

CODE	DESCRIPTION	WIDTH
10-017-000	Straight	7 mm
10-018-000	Straight	12.5 mm
10-019-000	Straight	20 mm
10-008-000	Straight	7 mm x 17 in



10-018-00

Osteotome

CODE	DESCRIPTION	TIP SIZE	LENGTH
46-2000	Straight	1/4 in 6 mm	11 in 279 mm
46-2001	Straight	3/8 in 10 mm	11 in 279 mm
46-2002	Straight	1/2 in 13 mm	11 in 279 mm
46-2003	Straight	5/8 in 16 mm	11 in 279 mm
46-2004	Straight	3/4 in 19 mm	11 in 279 mm
46-2005	Straight	1 in 25 mm	11 in 279 mm
46-2006	Straight	1 1/4 in 32 mm	11 in 279 mm
46-2010	Curved	1/4 in 6 mm	11 in 279 mm
46-2011	Curved	3/8 in 10 mm	11 in 279 mm
46-2012	Curved	1/2 in 13 mm	11 in 279 mm
46-2013	Curved	5/8 in 16 mm	11 in 279 mm
46-2014	Curved	3/4 in 19 mm	11 in 279 mm
46-2015	Curved	1 in 25 mm	11 in 279 mm
46-2016	Curved	1 1/4 in 32 mm	11 in 279 mm



46-2006

Osteotomes

Osteotome

CODE	DESCRIPTION	TIP SIZE		LENGTH	
46-3051	Curved	¼ in	6 mm	8½ in	216 mm
46-3052	Curved	⅜ in	10 mm	8½ in	216 mm
46-3053	Curved	½ in	13 mm	8½ in	216 mm
46-3054	Curved	⅝ in	16 mm	8½ in	216 mm
46-3055	Curved	¾ in	19 mm	8½ in	216 mm



46-3052

Osteotome

CODE	DESCRIPTION	BLADE WIDTH		LENGTH	
46-1021	Straight	¼ in	6 mm	7½ in	191 mm
46-1025	Straight	¼ in	6 mm	9½ in	241 mm
46-1022	Straight	⅝ in	6 mm	9½ in	241 mm
46-1019	Straight	⅜ in	10 mm	9½ in	241 mm
46-1020	Curved	¼ in	6 mm	7½ in	191 mm
46-1026	Curved	¼ in	6 mm	9½ in	241 mm
46-1023	Slightly Curved	⅝ in	6 mm	9½ in	241 mm
46-1024	Full Curved	¼ in	6 mm	9½ in	241 mm



46-1021

Sheehan Osteotome

CODE	DESCRIPTION	BLADE WIDTH		LENGTH	
27-6202	Straight	⅛ in	2 mm	6¼ in	160 mm
27-6204	Straight	¼ in	4 mm	6¼ in	160 mm
27-6206	Straight	¼ in	6 mm	6¼ in	160 mm
27-6208	Straight	⅓ in	8 mm	6¼ in	160 mm
27-6210	Straight	⅜ in	10 mm	6¼ in	160 mm
27-6215	Straight	⅝ in	15 mm	6¼ in	160 mm
27-6218	Straight	¾ in	18 mm	6¼ in	160 mm



27-6202

Osteotomes

Smith-Peterson Osteotome

Blade Thickness $\frac{1}{6}$ in (2 mm)

CODE	DESCRIPTION	BLADE WIDTH	LENGTH
46-2500	Straight	$\frac{1}{4}$ in 6 mm	8 in 203 mm
46-2501	Straight	$\frac{3}{8}$ in 10 mm	8 in 203 mm
46-2502	Straight	$\frac{1}{2}$ in 13 mm	8 in 203 mm
46-2503	Straight	$\frac{5}{8}$ in 16 mm	8 in 203 mm
46-2504	Straight	$\frac{3}{4}$ in 19 mm	8 in 203 mm
46-2505	Straight	1 in 25 mm	8 in 203 mm
46-2506	Straight	$1\frac{1}{4}$ in 32 mm	8 in 203 mm
46-2510	Curved	$\frac{1}{4}$ in 6 mm	8 in 203 mm
46-2511	Curved	$\frac{3}{8}$ in 10 mm	8 in 203 mm
46-2512	Curved	$\frac{1}{2}$ in 13 mm	8 in 203 mm
46-2513	Curved	$\frac{5}{8}$ in 16 mm	8 in 203 mm
46-2514	Curved	$\frac{3}{4}$ in 19 mm	8 in 203 mm
46-2515	Curved	1 in 25 mm	8 in 203 mm
46-2516	Curved	$1\frac{1}{4}$ in 32 mm	8 in 203 mm

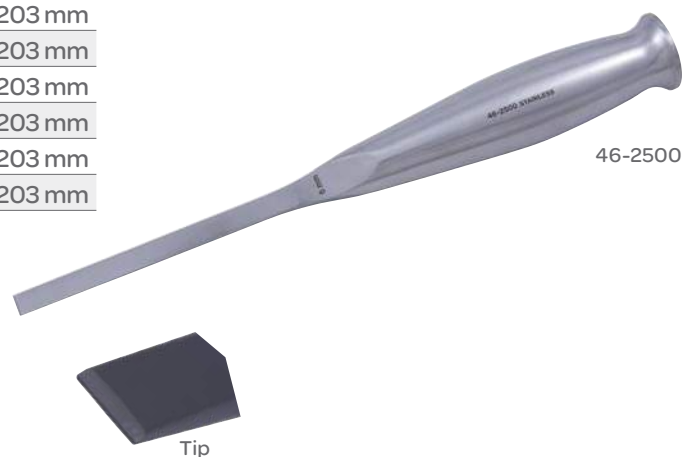

Smith-Peterson Osteotome

CODE	DESCRIPTION	BLADE WIDTH	LENGTH
28-7106	Straight	$\frac{1}{4}$ in 6 mm	8 in 203 mm
28-7112	Straight	$\frac{1}{2}$ in 13 mm	8 in 203 mm
28-7115	Straight	$\frac{5}{8}$ in 16 mm	8 in 203 mm
28-7120	Straight	$\frac{3}{4}$ in 19 mm	8 in 203 mm
28-7125	Straight	1 in 25 mm	8 in 203 mm
28-7130	Straight	$1\frac{1}{4}$ in 32 mm	8 in 203 mm
28-7156	Curved	$\frac{1}{4}$ in 6 mm	8 in 203 mm
28-7159	Curved	$\frac{3}{8}$ in 10 mm	8 in 203 mm
28-7162	Curved	$\frac{1}{2}$ in 13 mm	8 in 203 mm
28-7165	Curved	$\frac{5}{8}$ in 16 mm	8 in 203 mm
28-7175	Curved	1 in 25 mm	8 in 203 mm
28-7180	Curved	$1\frac{1}{4}$ in 32 mm	8 in 203 mm



Osteotomes

Stiletto Osteotome

CODE	DESCRIPTION	TIP SIZE	LENGTH
46-3061	Straight	¼ in 6 mm	8 ½ in 216 mm
46-3062	Straight	⅜ in 10 mm	8 ½ in 216 mm
46-3063	Straight	½ in 13 mm	8 ½ in 216 mm
46-3064	Straight	⅝ in 16 mm	8 ½ in 216 mm
46-3065	Straight	¾ in 19 mm	8 ½ in 216 mm



46-3061

US Army Osteotome

CODE	BLADE WIDTH	LENGTH
28-2106	¼ in 6 mm	6 ¼ in 160 mm
28-2112	⅜ in 12 mm	6 ¼ in 160 mm
28-2118	¾ in 18 mm	6 ¼ in 160 mm



28-2106

Picks

Pick

CODE	DESCRIPTION
10-129-000	Fracture Reduction



Tip

Plaster Tools (Shears)

Stille Plaster Shears

CODE	DESCRIPTION	LENGTH
40-5523	Stainless Steel	9 in 230 mm

Probes (Arthroscopic)

Probe

CODE	DESCRIPTION	TIP
1040501	Straight	
1010501		90°
1010502	Curved Left 30°	90°
1010503	Curved Right 30°	90°

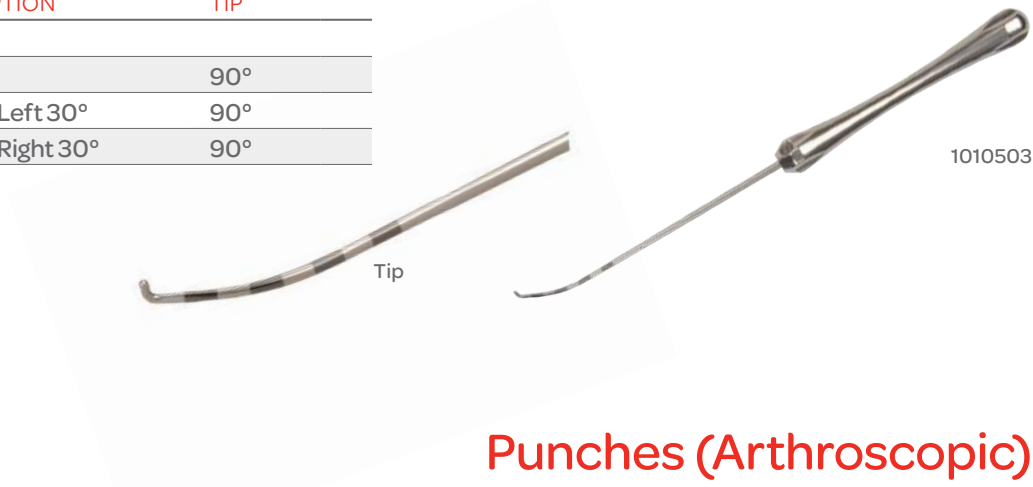

Punches (Arthroscopic)

Joint Punch

CODE	DESCRIPTION	LENGTH
1030101	Small	Teardrop, Straight
1030102	Small	Teardrop, Right 14°
1030103	Small	Left 14°



Knot Pusher

CODE
1020901

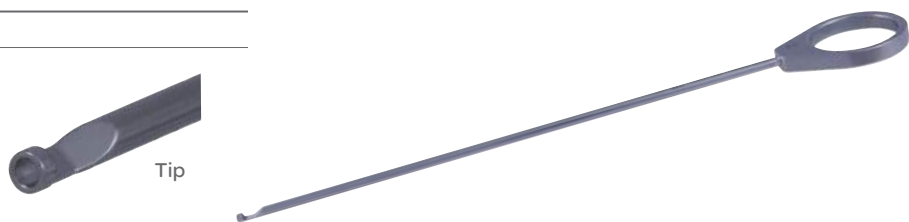

Punches (Arthroscopic)

Low Profile Punch

CODE	TIP	BITE WIDTH
1010101LP	Straight	1.7 mm
1010102LP	Up 15°	1.7 mm
1010138LP	Up 15°	2.6 mm
1010115LP	Up 15°	3.6 mm
1010117LP	Up 15°, Curved Left 15°	3.6 mm
1010119LP	Up 15°, Curved Right 15°	3.6 mm
1010131LP	Up 15°, Curved Up 15°	3.6 mm
1010139LP	Up 15°, Shaft Curved Up 15°	2.6 mm



1010101LP

Punch

90° Tip

CODE	DESCRIPTION	BITE WIDTH
1010128	Left, In-Line Handle	2.2 mm
1010125	Left, In-Line Handle	3.4 mm
1010129	Right In-Line Handle	2.2 mm
1010126	Right, In-Line Handle	
1010124	Left, Loop	3.2 mm
1010127	Right, Loop	3.2 mm



1010109

Tip

Punch

CODE	DESCRIPTION	WIDTH
1010122	Retro Left	2.4 mm
1010123	Retro Right	2.4 mm



1010122

Punches (Arthroscopic)

Punch

CODE	DESCRIPTION	BITE WIDTH
1000400	Straight Tip	0.8 mm
1010101	Straight Tip	1.7 mm
1010137	Straight Tip	2.6 mm
1010120	Straight	0.8 mm
1010113	Straight	3.6 mm
1040101	Straight	3.6 mm



Punch

CODE	DESCRIPTION	BITE WIDTH
1010111	Straight Tip, Blunt Nose	1.7 mm
1010134	Straight Tip, Short Nose	1.7 mm
1010112	Up 15° Tip, Blunt Nose	1.7 mm
1010135	Up 15° Tip, Short Nose	1.7 mm



Punch

Meniscal Lift

CODE	DESCRIPTION	BITE WIDTH
1010103	Straight	1.7 mm
1010114	Straight Tip	3.6 mm
1010116	Straight Tip	3.6 mm



Punches (Arthroscopic)

Punch

CODE	DESCRIPTION	BITE WIDTH
1010133	Straight Tip, Oval	3.6 mm



Punch

CODE	DESCRIPTION	BITE WIDTH
1010121	Up 15° Tip	0.8 mm
1000401	Up 15° Tip	0.8 mm
1010102	Up 15° Tip	1.7 mm
1010138	Up 15° Tip	2.6 mm

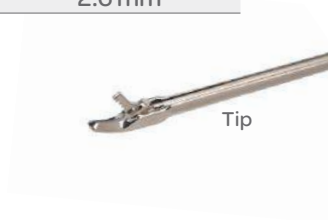

1010121

Punch

Up 15° Tip

CODE	DESCRIPTION	BITE WIDTH
1010105	Curved Left 15°	1.7 mm
1010107	Curved Right 15°	1.7 mm
1010109	Curved Up 15°	1.7 mm



1010105

Punches (Arthroscopic)

Punch

Up 15° Tip

CODE	DESCRIPTION	BITE WIDTH
1010104	Meniscal Lift	1.7 mm
1010106	Curved Left, Meniscal Lift	1.7 mm
1010108	Curved Right, Meniscal Lift	1.7 mm
1010110	Curved Up, Meniscal Lift	1.7 mm
1010118	Curved Left, Meniscal Lift	3.6 mm
1010130	Curved Right, Meniscal Lift	3.6 mm
1010132	Curved Up, Meniscal Lift	3.6 mm



Punch

Up 15° Tip

CODE	DESCRIPTION	BITE WIDTH
1010115	Straight Up 15°	3.6 mm
1010117	Curved Left 15°	3.6 mm
1010119	Curved Right 15°	3.6 mm
1010131	Curved Up 15°	3.6 mm
1010136	Round	5 mm



Punches (Micropunch)

Micropunch

CODE	DESCRIPTION
20-302	0°
20-342	45°

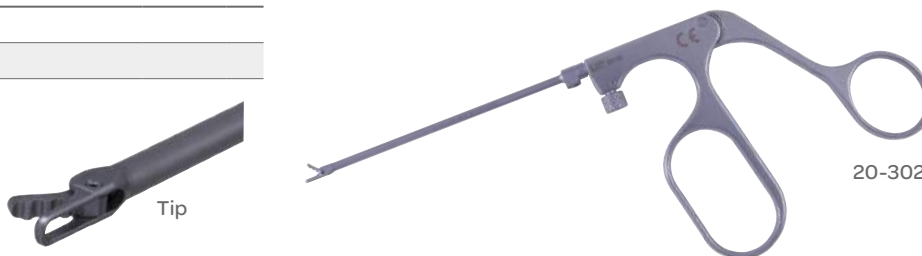

Rasps (Arthroscopic)

Rasp

CODE	DESCRIPTION	WORKING DIAMETER	WORKING LENGTH
1010701	Straight	4.6 mm	116 mm
1010702	Down Curve	6.1 mm	116 mm
1010703	Convex	6.1 mm	116 mm



Tip



1010703

Rasps (Bone)

Bone Rasp

Double-Ended

CODE	TIP	LENGTH
77-2004	#64, 3 and 4 mm	7 in 178 mm



Tip

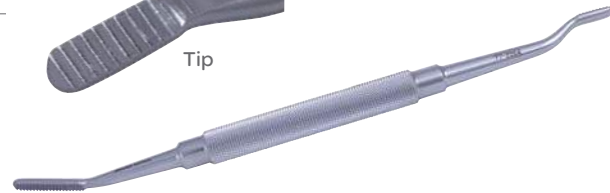

Putti Bone Rasp

Double-Ended

CODE	TIP	LENGTH
26-1501	Straight and Curved	10 ½ in 267 mm
26-1502	Round and Half Round	12 in 305 mm



26-1502

Rasps (Nail)

Nail Rasp

Double-Ended, Angled with Serrations

CODE	TIP	LENGTH
77-2003	#93, 2 mm	6¾ in 170 mm

Polokoff Rasp

Double-Ended

CODE	TIP	LENGTH
77-2005	3 and 4 mm	8½ in 216 mm
77-2006	5 and 6 mm	8½ in 216 mm



Reamers (Intramedullary)

IM Reamer

CODE	DESCRIPTION
11-012-000	9 mm
11-013-000	10 mm
11-014-000	11 mm
11-015-000	12 mm
11-016-000	13 mm
11-017-000	15 mm
11-018-000	17 mm
11-019-000	19 mm



Retractors



77-1241

Aufranc Cobra Retractor

CODE	DESCRIPTION	TIP	LENGTH
77-1241	Smooth, Pointed Tip	10 mm	10 ½ in 265 mm
77-1242	Serrated, Blunt Tip	10 mm	10 ½ in 265 mm
77-1243	Smooth, Blunt Tip	10 mm	10 ½ in 265 mm



Bennett Bone Retractor

CODE	BLADE	LENGTH
77-1206	2 ½ in 65 mm	9 ½ in 240 mm



77-1251

Blount Hip Retractor

CODE	DESCRIPTION	BLADE	LENGTH
77-1251	Single Prong	1 ½ in 38 mm	10 in 254 mm
77-1252	Double Prong	2 ¾ in 44 mm	10 in 254 mm



Browne Deltoid Retractor

CODE	BLADE	LENGTH
77-1015	2 ¾ x 2 ½ in 60 x 65 mm	10 ¾ in 273 mm

Retractors



Bristow-Bankart Humeral Retractor

CODE	PRONGS	BLADE
77-1011	2, Blunt	25 x 102 mm



Capsule Retractor

CODE	DESCRIPTION	BLADE WIDTH
77-1005	3 Sharp Prongs	22 mm



Cobra Retractor

CODE	DESCRIPTION	LENGTH
37-4105	Sharp, 1 ¼ in Tip	9 ¾ in 250 mm
37-4106	Blunt, 1 ¼ in Tip	9 ¾ in 250 mm



Collin Retractor

CODE	DESCRIPTION	LENGTH
22-1215	Double-Ended	6 in 152 mm

Retractors



Darrach Retractor

77-1008

CODE	JAW	TOTAL LENGTH
77-6005	9 mm	10¼ in 260 mm
77-6002	13 mm	10¼ in 260 mm
77-6003	19 mm	10¼ in 260 mm
77-6004	25 mm	10¼ in 260 mm



Fukuda Shoulder Retractor

77-1006

CODE	BLADE	LENGTH
77-1007	1¼ x 3⅜ in 32 x 81 mm	7 in 175 mm
77-1006	1½ x 3⅜ in 38 x 81 mm	7 in 175 mm



Tip



24-0911

Heiss Retractor

CODE	DESCRIPTION	PRONGS	LENGTH
24-0911	Sharp	4 x 4	4 in 100 mm
24-0912	Blunt	4 x 4	4 in 100 mm

Hohman Retractor



77-1189

CODE	DESCRIPTION	BLADE	LENGTH
77-1188	Curved 120°	22 mm	16 in 405 mm
77-1189	Curved 90°	40 mm	13 in 355 mm

Retractors

Hohman Retractor



CODE	DESCRIPTION	DIMENSIONS
77-1120	Finger Holes and Finger Ring	4 3/4 in 120 mm

Hohman Retractor



CODE	WIDTH	LENGTH
77-1122	15 mm	6 in 150 mm

Horizontal Retractor



CODE	DESCRIPTION	PRONGS	LENGTH
24-3500	Sharp	4 x 2 mm	12 in 305 mm

Israel Retractor



22-7204

CODE	DESCRIPTION	PRONGS	LENGTH
22-7204	Blunt	4	10 in 250 mm
22-7205	Blunt	5	10 in 250 mm
22-7206	Blunt	6	10 in 250 mm

Retractors



Kelly Retractor

23-4701

CODE	DESCRIPTION	BLADE	LENGTH
23-4701	Standard Handle	1½ x 2 in 38 x 50 mm	10¼ in 260 mm
23-4702	Standard Handle	2 x 2½ in 50 x 63 mm	10¼ in 260 mm
23-4703	Standard Handle	2½ x 3 in 63 x 76 mm	10¼ in 260 mm
23-4703	Standard Handle	3 x 3½ in 76 x 89 mm	10¼ in 260 mm

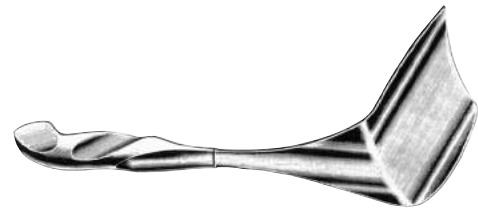

Kelly Retractor

23-4711

CODE	DESCRIPTION	BLADE	LENGTH
23-4711	Lamb	1¼ x 2 in 32 x 50 mm	10¼ in 260 mm
23-4712	Lamb	2 x 2½ in 50 x 63 mm	10¼ in 260 mm
23-4713	Lamb	2½ x 3 in 63 x 76 mm	10¼ in 260 mm
23-4714	Lamb	3 x 3½ in 76 x 89 mm	10¼ in 260 mm



Kelly Retractor

23-4715

CODE	DESCRIPTION	BLADE	LENGTH
23-4715	Grip Handle	1½ x 2 in 38 x 50 mm	10¼ in 260 mm
23-4716	Grip Handle	2 x 2½ in 50 x 63 mm	10¼ in 260 mm
23-4717	Grip Handle	2½ x 3 in 63 x 76 mm	10¼ in 260 mm
23-4718	Grip Handle	3 x 3½ in 76 x 89 mm	10¼ in 260 mm

Kolbel Retractor

CODE	DESCRIPTION	LENGTH
24-4175	2 x 2 in Prong	7 in 177 mm

Retractors



Lahey Retractor

CODE	DESCRIPTION	LENGTH
23-0306	Retractor	7¾ in 195 mm



Langenbeck Retractor

23-0710

CODE	BLADE	LENGTH
23-0710	¾ x 1½ in 10 x 38 mm	8¾ in 220 mm



Markham-Meyerding Retractor

24-4591

CODE	DESCRIPTION	PRONGS	LENGTH
24-4591	Left	25 x 30 mm	7⅞ in 180 mm
24-4590	Right	25 x 30 mm	7⅞ in 180 mm



Mcelroy Angulated Retractor

77-1191

CODE	DESCRIPTION	LENGTH
77-1191	T-Handle Retractor	10¾ in 270 mm



Murphy Retractor

22-5004

CODE	DESCRIPTION	PRONGS	DIMENSIONS
22-5004	Sharp	4	7¾ in 195 mm
22-5006	Sharp	6	7¾ in 195 mm
22-5103	Blunt	3	7¾ in 195 mm
22-5104	Blunt	4	7¾ in 195 mm

Retractors



20-1002

Meyering Finger Retractor

CODE	DESCRIPTION	LENGTH
20-1001	#1	7½ in 180 mm
20-1002	#2	7½ in 180 mm



Oberhill Retractor

CODE	DESCRIPTION	BLADES	LENGTH
24-3449	Four-Prongs, Hinged Blades	1 x 1¼ in	13 in 355 mm



Ollier Retractor

CODE	DESCRIPTION	PRONGS	LENGTH
22-7002	Blunt	4	8½ in 215 mm



22-1418

Parker Retractor

Double-Ended

CODE	DESCRIPTION	LENGTH
22-1413	Set of 2	5 in 125 mm
22-1418	Set of 2	7 in 175 mm

Retractors

Pelvic Retractor



CODE	DESCRIPTION	LENGTH
77-1014	24 mm Wide Blade	10 3/4 in 270 mm



23-4501

Richardson Retractor

CODE	DESCRIPTION	BLADE	LENGTH
23-4501	Standard	3/4 x 1 in 19 x 25 mm	9 1/2 in 240 mm
23-4502	Standard	1 x 1 1/4 in 25 x 32 mm	9 1/2 in 240 mm
23-4503	Standard	1 1/2 x 1 1/2 in 38 x 38 mm	9 1/2 in 240 mm
23-4504	Standard	3/4 x 2 in 19 x 50 mm	9 1/2 in 240 mm
23-4505	Standard	1 5/8 x 2 1/2 in 41 x 57 mm	9 1/2 in 240 mm



23-4514

Richardson Retractor

CODE	DESCRIPTION	BLADE	LENGTH
23-4511	Lamb	3/4 x 1 in 19 x 25 mm	10 1/2 in 260 mm
23-4512	Lamb	1 x 1 1/4 in 25 x 32 mm	10 1/2 in 260 mm
23-4513	Lamb	1 1/2 x 1 1/2 in 38 x 38 mm	10 1/2 in 260 mm
23-4514	Lamb	3/4 x 2 in 19 x 50 mm	10 1/2 in 260 mm

Richardson Retractor

CODE	DESCRIPTION	BLADE	LENGTH
23-4515	Grip Handle	3/4 x 1 in 19 x 25 mm	9 1/2 in 240 mm
23-4516	Grip Handle	1 x 1 1/4 in 25 x 32 mm	9 1/2 in 240 mm
23-4517	Grip Handle	1 1/2 x 1 1/2 in 38 x 38 mm	9 1/2 in 240 mm
23-4518	Grip Handle	3/4 x 2 in 19 x 50 mm	9 1/2 in 240 mm
23-4520	Grip Handle	1 1/4 x 4 in 32 x 100 mm	9 1/2 in 240 mm

Retractors



23-4550

Richardson-Eastman Retractor

Double-Ended

CODE	DESCRIPTION	LENGTH
23-4550	Set of Two	11 in 279 mm
23-4551	Small Only	11 in 279 mm
23-4552	Large Only	11 in 279 mm



22-1616

Roux Retractor

CODE	DESCRIPTION	DIMENSIONS
22-1614	Small	$\frac{7}{8} \times 1\frac{1}{8} \times 6\frac{3}{4}$ in 22 x 29 x 171 mm
22-1615	Medium	$1 \times 1\frac{1}{2} \times 6\frac{3}{4}$ in 25 x 38 x 171 mm
22-1616	Large	$1\frac{1}{4} \times 1\frac{3}{4} \times 6\frac{3}{4}$ in 32 x 44 x 171 mm



23-1501

Sauerbruch Retractor

CODE	DESCRIPTION	BLADE DIMENSIONS	LENGTH
23-1501	#1	$\frac{3}{4} \times 1\frac{3}{4}$ in 19 x 44 mm	9 in 230 mm
23-1502	#2	$1\frac{5}{16} \times 2\frac{1}{8}$ in 24 x 54 mm	9 in 230 mm
23-1503	#3	$1\frac{3}{16} \times 2\frac{7}{8}$ in 21 x 73 mm	9 in 230 mm



20-0508

Senn Retractor

CODE	DESCRIPTION	LENGTH
20-0508	Double-Ended, Sharp	$6\frac{1}{4}$ in 160 mm
20-0509	Double-Ended, Blunt	$6\frac{1}{4}$ in 160 mm

Retractors



22-1553

Sofield Retractor

CODE	DESCRIPTION	BLADES
22-1551	Double-Ended	63 x 13 mm and 38 x 13 mm
22-1552	Double-Ended	70 x 13 mm and 44 x 13 mm
22-1553	Double-Ended	83 x 16 mm and 51 x 16 mm
22-1554	Double-Ended	89 x 16 mm and 57 x 16 mm
22-1555	Double-Ended	102 x 19 mm and 70 x 19 mm
22-1556	Double-Ended	114 x 19 mm and 76 x 19 mm

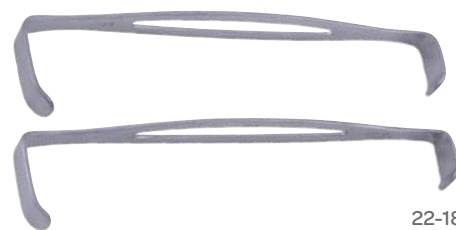

22-1821

US Army Retractor

CODE	DESCRIPTION	LENGTH
22-1821	Retractor Set of 2	8¼ in 210 mm



Volkman Retractor

CODE	DESCRIPTION	PRONGS	LENGTH
22-5806	Sharp	6	9½ in 240 mm

Retractors



22-2603

Volkman Retractor

CODE	DESCRIPTION	PRONGS	LENGTH
22-2602	Sharp	2	4 ½ in 115 mm
22-2603	Sharp	3	4 ½ in 115 mm
22-2604	Sharp	4	4 ½ in 115 mm
22-2606	Sharp	6	4 ½ in 115 mm
22-2703	Blunt	3	4 ½ in 115 mm
22-2704	Blunt	4	4 ½ in 115 mm
22-2706	Blunt	6	4 ½ in 115 mm



22-3402

Volkman Retractor

CODE	DESCRIPTION	PRONGS	LENGTH
22-3402	Sharp	2	8 ¾ in 220 mm
22-3403	Sharp	3	8 ¾ in 220 mm
22-3404	Sharp	4	8 ¾ in 220 mm
22-3406	Sharp	6	8 ¾ in 220 mm
22-3502	Blunt	2	8 ¾ in 220 mm
22-3503	Blunt	3	8 ¾ in 220 mm
22-3504	Blunt	4	8 ¾ in 220 mm

Retractors (Glenoid)



Hinterman Retractor

CODE	DESCRIPTION	LENGTH
78-5599	With K-Wire Guide	7 in 175 mm

Retractors (Hand)



20-1776

Hayes Hand Retractor

CODE	DESCRIPTION	LENGTH
20-1776	Hand Retractor	6¼ in 160 mm
20-1777	Hand Retractor	6¼ in 160 mm

Retractors (Hip)



13-023-000

Minimally Invasive Hip Retractor

CODE	SIZE	DESCRIPTION	DIMENSIONS
13-023-000	#1, Curved	25 mm Blade Pointed Tip	9 x 5/32 x 5/8 in 229 x 4 x 16 mm
13-024-000	#2, Curved	Blunt Tip	9 x 1/8 x 1/2 in 229 x 3 x 13 mm
13-025-000	#3, Offset		9 x 3/32 x 3/8 in 229 x 2 x 10 mm
13-026-000	#4	Long Hohmann	9 x 1/16 x 1/4 in 229 x 1.6 x 6.3 mm
13-027-000	#5	Long Hohmann, Short Curved Blade	10 in 254 mm
13-029-000	#7	Long Hohmann, Narrow Blade	
13-030-000	#8	Small Hohmann	

Retractors (Knee)



Blount (Bird Beak) Knee Retractor

CODE	DESCRIPTION	TIP	LENGTH
77-5650	Knee Retractor	9 mm, Distal	7 in 175 mm

Retractors (Knee)

Doane (Z) Knee Retractor

Double-Ended



78-5998

CODE	DESCRIPTION	BLADE	WIDTH	LENGTH
78-5999	Medium	152 x 63 mm	152 x 76 mm	11 mm 7 in 175 mm
78-5998	Large	152 x 57 mm	152 x 69 mm	11 mm 7 in 175 mm

Minimally Invasive Knee Retractor



13-035-000

CODE	SIZE	DESCRIPTION	LENGTH
13-035-000	#1	Small Hohmann	
13-036-000	#2	Large Hohmann	
13-037-000	#3	Condylar Retractor	
13-038-000	#4	Superior Retractor	
13-039-000	#5	Patellar Retractor	7 in 175 mm
13-040-000	#6	Collateral Retractor, Left	7 in 175 mm
13-041-000	#7	Collateral Retractor, Right	4 3/4 in 120 mm
13-042-000	#8	Soft Tissue Retractor	11 mm



77-5601

Smillie Knee Retractor

CODE	DESCRIPTION	BLADE	LENGTH
77-5601	Knee Retractor	3/4 x 1 1/4 in	5 1/2 in 140 mm
77-5602	Knee Retractor	3/4 x 1 3/4 in	5 1/2 in 140 mm
77-5603	Knee Retractor	3/4 x 2 3/8 in	5 1/2 in 140 mm

Retractors (Knee)

Smillie Knee Retractor

CODE	DESCRIPTION	BLADE	LENGTH
77-5610	Knee Retractor	½ x ¾ in 13 x 18 mm	5 ½ in 140 mm
77-5611	Knee Retractor	½ x 1 in 13 x 25 mm	5 ½ in 140 mm



Smillie Knee Retractor

CODE	DESCRIPTION	BLADE	LENGTH
77-5621	Double-Curved	½ x 2 ⅞ in 13 x 55 mm	5 ½ in 140 mm

Retractors (Mini)

Hohman Mini Retractor

CODE	DESCRIPTION	LENGTH
77-1050	Mini	6 ¼ in 160 mm
77-1052	Mini	6 ¼ in 160 mm



77-1050

Retractors (PCL)

Worland PCL Retractor

CODE	TIP	LENGTH
13-001-000	13 mm	12 ½ in 320 mm



Retractors (Self-Retaining)

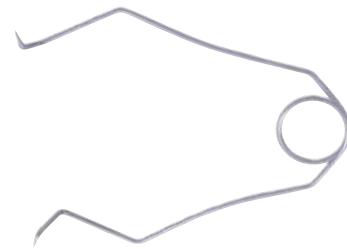

24-0307

Farr Spring Retractor

CODE	DESCRIPTION	PRONGS	LENGTH
24-0306	Spring Retractor	1 in 25 mm	9 in 230 mm
24-0307	Spring Retractor	1 in 25 mm	5½ in 140 mm

Spring Retractor

CODE	DESCRIPTION	PRONGS	LENGTH
24-0352	Spring Retractor	1x1	4¼ in 105 mm

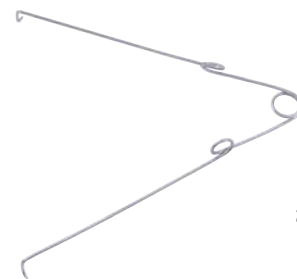

24-0302

Spring Retractor

CODE	DESCRIPTION	PRONGS	LENGTH
24-0301	Spring Retractor	1x1	3½ in 90 mm
24-0302	Spring Retractor	1x1	4½ in 115 mm

Spring Retractor

CODE	DESCRIPTION	PRONGS	LENGTH
24-0303	Spring Retractor	3x3	3½ in 90 mm
24-0304	Spring Retractor	3x3	4½ in 115 mm

Retractors (Self-Retaining)



24-2210

Weitlaner Retractor

CODE	DESCRIPTION	PRONGS	LENGTH
24-2210	Sharp	2 x 3	4 ½ in 115 mm
24-2213	Sharp	3 x 4	5 ½ in 140 mm
24-2216	Sharp	3 x 4	6 ½ in 165 mm
24-2220	Sharp	3 x 4	8 in 200 mm
24-2224	Sharp	3 x 4	9 in 230 mm
24-2211	Blunt	3 x 4	4 ½ in 115 mm
24-2214	Blunt	3 x 4	5 ½ in 140 mm
24-2217	Blunt	3 x 4	6 ½ in 165 mm
24-2221	Blunt	3 x 4	8 in 200 mm
24-2225	Blunt	3 x 4	9 in 228 mm



24-3014

Weitlaner-Beckmann Retractor

Hinged Arms

CODE	DESCRIPTION	PRONGS	LENGTH
24-3014	Blunt	3 x 4	5 ½ in 140 mm
24-3017	Blunt	3 x 4	6 ½ in 165 mm
24-3021	Blunt	3 x 4	8 ½ in 215 mm
24-3024	Blunt	3 x 4	9 ½ in 240 mm
24-3023	Sharp	3 x 4	9 ½ in 240 mm



24-4760

Wiltse-Gelpi Retractor

CODE	DESCRIPTION	LENGTH
24-4760	Deep Sharp Blades, Sharp Prongs	11 in 280 mm
24-4760-L	Deep Sharp Blades, Sharp Prongs, Extra Long	14 in 355 mm

Retractors (Soft Tissue)

Kolbel Soft Tissue Retractor

Set of Two

CODE	BLADE	BLADE
24-4617	Small Blade	36 x 36 mm
24-4618	Large Blade	53 x 36 mm
24-4174	Blade	20 x 53 mm

Rongeurs (Arthroscopic)

Rongeur

CODE	DESCRIPTION	BITE WIDTH
1010401	Straight Tip	3 mm
1010402	Straight Tip, Curved up 15°	3 mm
1040401	Straight	4 mm

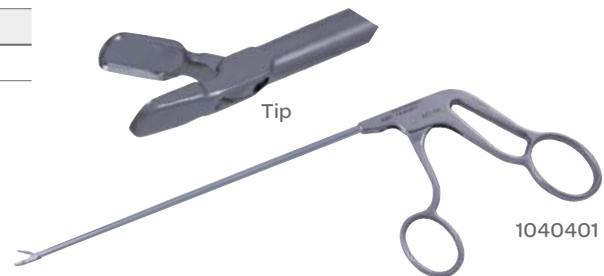

Rongeurs (Bone)

Bane Bone Rongeur

CODE	DESCRIPTION	JAWS	LENGTH
30-3818	Curved	5 mm	7 1/8 in 180 mm



Rongeurs (Bone)

Beyer Rongeur

CODE	DESCRIPTION	JAWS	LENGTH
31-1103	Curved	3 mm	7 in 175 mm
31-1104	Curved	4 mm	7 in 175 mm



Beyer Rongeur

CODE	DESCRIPTION	LENGTH
53-1100	Curved, Double Action	7 in 178 mm



Blumenthal Rongeur

CODE	DESCRIPTION	JAWS	LENGTH
30-2547	Angled 30°	4 mm	6 ¼ in 160 mm
30-2545	Angled 45°	4 mm	6 ¼ in 160 mm
30-2546	Angled 90°	4 mm	6 ¼ in 160 mm



Rongeurs (Bone)

Cottle-Jansen Rongeur

CODE	DESCRIPTION	LENGTH
30-5312	Angled Jaws, 12 x 5 mm	6 $\frac{3}{4}$ in 170 mm

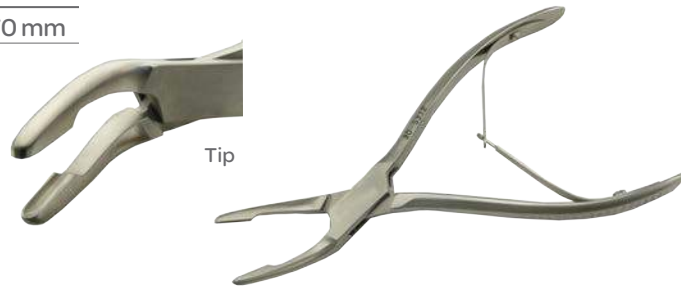

Cushing Rongeur

CODE	DESCRIPTION	JAWS	LENGTH
30-3185	Straight	6 mm	8 in 200 mm
30-3184	Curved	6 mm	8 in 200 mm

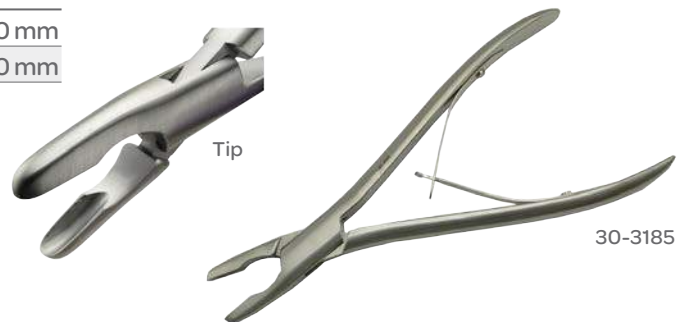

Dawson-Yuhl-Leksell Rongeur

CODE	DESCRIPTION	LENGTH
31-0931	5 x 13 mm Jaw	11 $\frac{1}{2}$ in 290 mm

De Vilbiss Rongeur

CODE	DESCRIPTION	LENGTH
53-1030	With One Extra Blade	8 $\frac{1}{16}$ in 205 mm

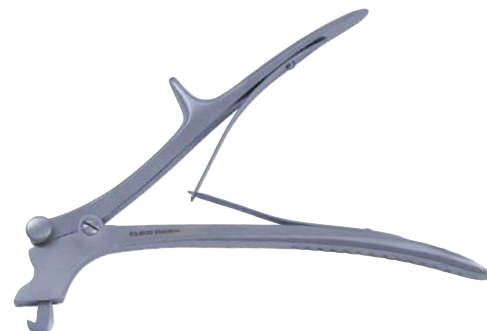

Rongeurs (Bone)

Echlin Duckbill Rongeur

CODE	DESCRIPTION	JAWS	LENGTH
31-6102	Angled	2x10 mm	9 in 230 mm

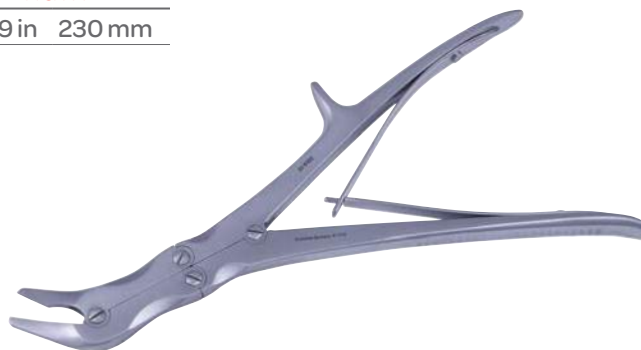

Friedman Bone Rongeur

Curved

CODE	DESCRIPTION	JAWS	LENGTH
30-0514	Delicate	4.0 mm Wide	5 1/2 in 140 mm
30-0516	Curved	4 x 11 mm Bite	5 1/2 in 140 mm



30-0514

Friedman Micro Rongeur

CODE	DESCRIPTION	JAWS	LENGTH
30-0201	Straight, Very Delicate	1.5 mm	5 1/2 in 140 mm
30-0203	Straight, Delicate	2 mm	6 in 150 mm
30-0202	Curved, Very Delicate	1.5 mm	5 1/2 in 140 mm
30-0204	Curved, Delicate	2 mm	6 in 150 mm



30-0202

Rongeurs (Bone)

Fulton Rongeur

CODE	DESCRIPTION	JAWS	LENGTH
31-0811	Curved	7 mm	9½ in 240 mm



Leksell Rongeur

CODE	DESCRIPTION	JAWS	LENGTH
31-5103	Slight Curved Handles	3 mm	9 in 230 mm
31-5105	Slight Curved Handles	5 mm	9 in 230 mm
31-5108	Slight Curved Handles	8 mm	9 in 230 mm



31-5105

Leksell Rongeur

CODE	DESCRIPTION	JAWS	LENGTH
31-5303	Full Curved Handles	3 mm	9 in 230 mm

Rongeurs (Bone)

Lempert Rongeur

CODE	DESCRIPTION	BITE	LENGTH
53-1108	Straight	1/16 in 2 mm	6 1/8 in 156 mm
53-1102	Curved	1/16 in 2 mm	6 1/8 in 156 mm



53-1102

Lempert Rongeur

Slender Pattern

CODE	DESCRIPTION	JAWS	LENGTH
30-7620	Straight	2.5 mm	6 1/4 in 160 mm
30-7623	Straight	2.5 mm	7 1/2 in 190 mm
30-7622	Curved	2.5 mm	6 1/4 in 160 mm
30-7624	Curved	2.5 mm	7 1/2 in 190 mm
30-7625	Curved	2.5 mm	7 1/2 in 190 mm

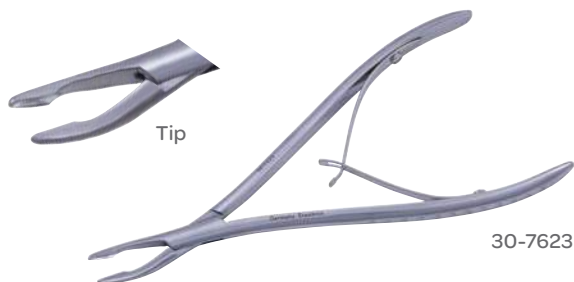

30-7623

Luer Bone Rongeur

CODE	DESCRIPTION	WIDTH	LENGTH
30-5217	Straight	8 mm	7 1/8 in 180 mm



Rongeurs (Bone)

Luer Bone Rongeur

CODE	DESCRIPTION	BITE	LENGTH
53-1010	Straight	1/16 in 2 mm	7 in 178 mm
53-1011	Curved	1/16 in 2 mm	7 in 178 mm



53-1010

Olivecrona Rongeur

CODE	DESCRIPTION	LENGTH
31-0401	Curved Light	7 3/4 in 196 mm



Tip

Reiner Bone Rongeur

CODE	DESCRIPTION	LENGTH
53-1015	Curved, Bite 3 x 13 mm	7 in 178 mm
53-1016	Curved, Bite 4 x 14 mm	7 in 178 mm



53-1015

Rongeurs (Bone)

Reiner Rongeur

CODE	DESCRIPTION	LENGTH
30-7627	4 mm Bite	7 in 178 mm

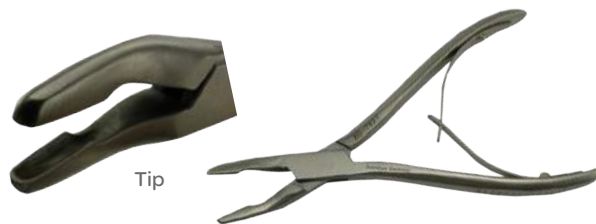

Rongeur

CODE	DESCRIPTION
15-003-000	Cement, Serrated Teeth, 300 mm



Ruskin Bone Rongeur

CODE	DESCRIPTION	JAWS	LENGTH
31-0605	Straight	5 mm	7 1/8 in 180 mm
31-0625	Straight	5 mm	9 1/2 in 240 mm
31-0705	Curved	5 mm	7 1/8 in 180 mm
31-0725	Curved	6 mm	7 1/4 in 184 mm
31-0706	Curved	5 mm	9 1/2 in 240 mm

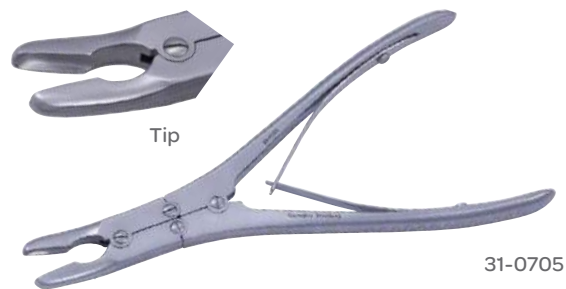

Ruskin Duckbill Rongeur

CODE	DESCRIPTION	JAWS	LENGTH
31-0765	Curved to Side	5 mm	7 1/8 in 180 mm



Rongeurs (Bone)

Ruskin Rongeur

Double-Action

CODE	DESCRIPTION	LENGTH
53-1310	Straight, 4 x 33 mm Bite	7¼ in 185 mm
53-1312	Straight, 5 x 33 mm Bite	7¼ in 185 mm
53-1311	Curved, 4 x 33 mm Bite	7¼ in 185 mm
53-1313	Curved, 5 x 33 mm Bite	7¼ in 185 mm



53-1310

Ruskin Rongeur

CODE	DESCRIPTION	LENGTH
31-0504	Curved, 4 mm	6 in 150 mm

Sauerbruch-Stille Bone Rongeur

Double-Action

CODE	DESCRIPTION	JAWS	LENGTH
31-3097	Straight, Square Jaws	20 mm Wide	11 in 280 mm
31-3096	Curved, Round Jaws	20 mm Wide	11 in 280 mm



31-3096

Semb Stille Rongeur

CODE	DESCRIPTION	LENGTH
31-3153	Curved	9 in 230 mm



Rongeurs (Bone)

Smith-Peterson Rongeur

CODE	DESCRIPTION	LENGTH
31-0913	Slight Curve	9½ in 240 mm



Stille-Luer Bone Rongeur

CODE	DESCRIPTION	JAWS	LENGTH
31-3023	Straight	10 mm	9 in 230 mm
31-3123	Curved	10 mm	9 in 230 mm
31-3121	Curved	10 mm	10½ in 265 mm



Stille-Luer Bone Rongeur

CODE	DESCRIPTION	JAWS	LENGTH
31-3027	Straight	17 mm	10½ in 265 mm



Stille-Luer Duckbill Bone Rongeur

CODE	DESCRIPTION	JAWS	LENGTH
31-3183	Angled	7 mm	9 in 230 mm



Rongeurs (Bone)

Stille-Luer Echlin Rongeur

CODE	DESCRIPTION	JAWS	LENGTH
31-3193	Angled	5 mm	9 in 230 mm

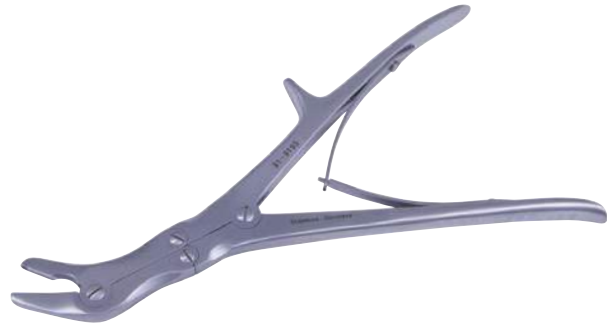

Stille-Luer Rongeur

CODE	DESCRIPTION	LENGTH
53-1130	10 mm, Angular, Straight, Flat on Jaw	8½ in 216 mm
53-1131	Curved, 10 mm, Bite	8½ in 216 mm
53-1118	Angular, 5 mm, Flat Lower Jaw	9½ in 241 mm
53-1133	Straight, 5 mm, Angular	9½ in 241 mm



53-1130

Zaufal-Jansen Rongeur

CODE	DESCRIPTION	JAWS	LENGTH
31-1105	Double-Action	5x15 mm	7 in 175 mm

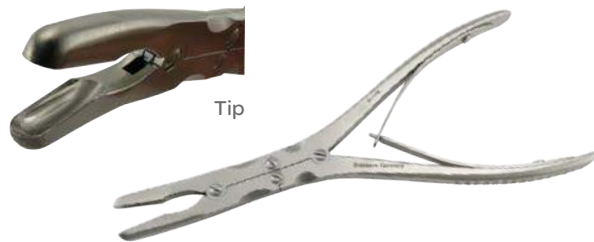

Tip

Zaufal-Jansen Rongeur

Bite 4 x 30 mm

CODE	DESCRIPTION	BITE	LENGTH
53-1095	Curved, Double-Action	4 x 30 mm	6¾ in 170 mm



Rongeurs (Cement Removal)

Rongeur

CODE	DESCRIPTION	LENGTH
15-002-000	Cement	10 in 250 mm



Rongeurs (Mini)

Ruskin Mini Rongeur

CODE	DESCRIPTION	JAWS	LENGTH
31-0402	Straight	2 mm	6 in 150 mm
31-0403	Straight	3 mm	6 in 150 mm
31-0502	Curved	2 mm	6 in 150 mm
31-0503	Curved	3 mm	6 in 150 mm

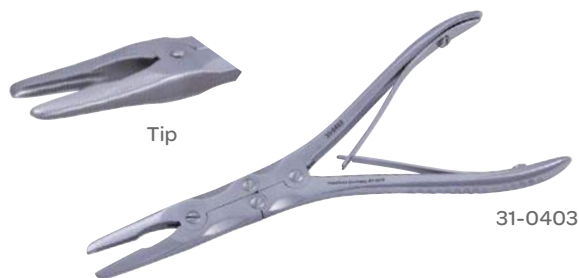

Rongeurs (Synovectomy)

Kleinert-Kutz Synovectomy Rongeur

CODE	DESCRIPTION	JAWS	LENGTH
30-7613	Slightly Curved	2 mm	5 ½ in 140 mm
30-7614	Fully Curved	2 mm	5 ½ in 140 mm

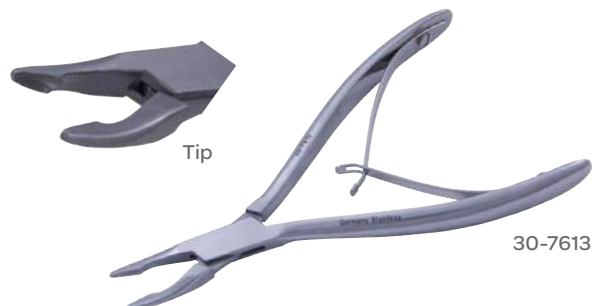

Rongeurs (Synovectomy)

Kleinert-Kutz Synovectomy Rongeur

CODE	DESCRIPTION	JAWS	LENGTH
31-0552	Slight Curved	2 x 13 mm	6 in 150 mm
31-0553	Slight Curved	3 x 16 mm	6 in 150 mm



31-0552

Scissors (Arthroscopic)

Scissors

CODE	DESCRIPTION
1010202	20° Tip, Hooked Left, Loop
1000442	20° Tip, Hooked Left Loop
1010210	60° Tip, Hooked Left, Loop
1010204	20° Tip, Hooked Right, Loop
1000443	20° Tip, Hooked Right Loop
1010212	60° Tip, Hooked Right, Loop
1010208	20° Tip, Short Serrated Left, Loop
1010209	20° Tip, Short Serrated Right, Loop



1010202

Scissors (Cartilage)

Martin Cartilage Scissors

CODE	DESCRIPTION	LENGTH
77-5520	Two Serrated Blades	8 in 200 mm



Shuttles (Arthroscopic)

Suture Shuttle

CODE	DESCRIPTION
1020701	Straight
1000641	Straight
1000684	Straight
1020702	45° Left
1000642	45° Left
1000685	45° Left
1020703	45° Right
1000643	45° Right
1000686	45° Right
1000644	35° Up
1000687	35° Up
1020704	35° Up



Skids (Bone)

Murphy-Lane Bone Skid Retractor

CODE	LENGTH
77-1193	12in 305 mm



Skids (Hip & Shoulder)

Meyerding Hip & Shoulder Skid

CODE	LENGTH
77-1190	13in 330 mm

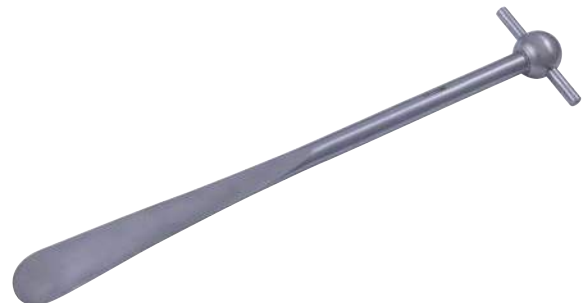

Skids (Lever)

Skid Lever Retractor

CODE	DESCRIPTION	LENGTH
77-4190	Double-Ended	6¼in 160 mm



Splitters (Cement)

Acetabular Cement Splitter

CODE	DESCRIPTION
10-011-000	Round



Flag Splitter

CODE
10-001-000



"V" Splitter

CODE
10-002-000



Tamps (Bone)

Bone Chip Tamp

CODE	DESCRIPTION	HEAD	LENGTH
27-9415	Round Head	6.3 mm	9½ in 241 mm
27-9411	Rectangular Head	2 x 9 mm	10 in 251 mm
27-9412	Rectangular Head	6 x 9 mm	10 in 251 mm
27-9413	Rectangular Head	3 x 16 mm	10 in 251 mm



27-9415

Bone Tamp

CODE	DESCRIPTION	LENGTH
27-9502	2 mm	6 in 152 mm
27-9503	3 mm	6 in 152 mm
27-9504	4 mm	6 in 152 mm
27-9505	5 mm	6 in 152 mm
27-9506	6 mm	6 in 152 mm
27-9507	7 mm	6 in 152 mm
27-9508	8 mm	6 in 152 mm
27-9520	20 mm	8 in 203 mm



27-9502

Caspar Bone Tamp

CODE	DESCRIPTION	LENGTH
27-9516	5 mm	8 in 203 mm



Sypert Tamp

CODE	DESCRIPTION	LENGTH
27-9534	4 x 10 mm	11½ in 292 mm
27-9535	5 x 15 mm	11½ in 292 mm
27-9536	6 x 20 mm	11½ in 292 mm



27-9534

Taps

Tap

CODE	DESCRIPTION
11-101-000	4.5 mm
11-102-000	6.5 mm



11-101-000

Wire & Traction (Pliers)

Pliers/Cutter

CODE	DESCRIPTION	LENGTH
14-5065	3.5 Tip, Flat Nose	6½ in 165 mm



Wire Extraction Pliers

CODE	DESCRIPTION	LENGTH
32-113	Fine Tungsten Carbide Jaws, 6 mm Jaw	7 in 175 mm



Wire & Traction (Pliers/Cutter)

Wire Cutting Pliers

CODE	DESCRIPTION	LENGTH
76-4573	Fine Tungsten Carbide	9 in 230 mm



Wire & Traction (Tightener)

Loute Wire Tightener

CODE	LENGTH
76-0550	8½ in 215 mm



Wire & Traction (Traction Bow)

Boelher Wire & Pin Traction Bow

CODE	DESCRIPTION	DIMENSIONS
76-4401	Small	90 x 75 mm
76-4402	Medium	106 x 90 mm
76-4403	Large	210 x 150 mm



76-4401

Kirschner Bow

CODE	DESCRIPTION	LENGTH
76-4001	Medium	5¾ in 145 mm
76-4002	Large	7½ in 190 mm
76-4003	Extra Large	9½ in 240 mm

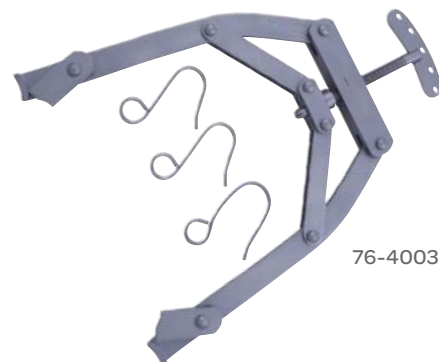

76-4003

Wire & Traction (Twister)

Rubio Wire Twister

Fine Tungsten Carbide Inserts

CODE	DESCRIPTION	LENGTH
32-302	Snub Nose	5¼ in 135 mm



Ultra™ Wire Twister & Sternal Needle Holder

Fine Tungsten Carbide Inserts

CODE	DESCRIPTION	LENGTH
32-122	Blunt Tips	6 in 150 mm
32-123		6¾ in 170 mm



32-122

Wire Twister & Tightener

CODE	LENGTH
14-5635	6¼ in 160 mm



Wire & Traction (Wire Cutter)

Cannulated Pin Cutter

End Cut

CODE	DESCRIPTION	LENGTH
14-3030	Maximum Capacity 0.062 in 1.6 mm	7½ in 190 mm



Double Action Side Cutter

Double Action Side Cut

CODE	DESCRIPTION	LENGTH
32-3371	Straight Jaw	9 in 229 mm
32-3372	Angled Jaw	6½ in 165 mm
32-3373	Angled Jaw	9 in 229 mm



32-3371

Flush Wire Cable Cutter

Fine Tungsten Carbide Jaws

CODE	DESCRIPTION	LENGTH
32-129	Double-Action, Maximum Capacity 1.6 mm	7 in 175 mm

