



Scan the code above  
to learn more about our  
Ear, Nose & Throat portfolio.

# Ear, Nose & Throat Portfolio



symmetry surgical™

CE Germany 129

# Ear, Nose & Throat



Adenotomes	ENT-2	Foot Plate Hooks	ENT-43	Presses	ENT-93
Arch Bars	ENT-3	Forceps	ENT-44	Probes	ENT-94
Awls	ENT-3	Handles	ENT-64	Punches	ENT-95
Brushes	ENT-3	Hooks	ENT-64	Rasps	ENT-100
Calipers	ENT-4	Inserters	ENT-71	Retractors	ENT-106
Cannulas	ENT-4	Instrument Covers	ENT-71	Rongeurs	ENT-118
Chisels	ENT-5	Knives	ENT-72	Saws	ENT-123
Clamps	ENT-7	Laryngoscope	ENT-79	Scissors	ENT-123
Connectors	ENT-7	Loops	ENT-79	Snares	ENT-138
Containers	ENT-8	Mallets	ENT-79	Speculums	ENT-139
Crushers	ENT-8	Mirrors	ENT-80	Spreaders	ENT-145
Curettes	ENT-9	Mobilizers	ENT-80	Suction Tubes	ENT-145
Cutting Blocks	ENT-18	Mouth Gags	ENT-81	Syringes	ENT-148
Dilators	ENT-18	Needles	ENT-83	Tracheal Tubes	ENT-148
Dissectors	ENT-19	Nippers	ENT-85	Trocars	ENT-148
Elevators	ENT-20	Sponges	ENT-86	Tuning Forks	ENT-149
Energy	ENT-30	Osteotomes	ENT-86	Wire Guides	ENT-149
Excavators	ENT-43	Picks	ENT-89		

Questions? Contact us at [customerservice@symmetrysurgical.com](mailto:customerservice@symmetrysurgical.com) or learn more at [symmetrysurgical.com](http://symmetrysurgical.com)



# The Surgical Instrument Desk Reference

---

## How to Use Our Catalog

---

The Symmetry Surgical catalog is designed with you in mind, to be your trusted resource for surgical instrumentation. We took great care in creating an easy-to-use, robust catalog and we think you'll be pleased with the design as you become more familiar with our broad portfolio.

## Layout

---

The catalog is organized by surgical specialty *and* product function.

And we know that it is difficult to pick up an instrument and know what specialty it's listed in. To make your job easier, we've sorted the instruments in our portfolio by surgical function, too, including Energy, Laparoscopic, Retractors and Sterilization Solutions.

## U.S. Customer Service

---

Your Symmetry Surgical Customer Service team wants to make ordering surgical instruments the easiest part of your day. We accept orders via phone, fax, email, our website, Global Healthcare Exchange (GHX) and through the mail.

### PHONE

1.800.251.3000

(Available Monday through Friday, 8:30 AM–6:30 PM EST)

### FAX

1.800.342.3272

### EMAIL

[customerservice@symmetrysurgical.com](mailto:customerservice@symmetrysurgical.com)

### ONLINE

[symmetrysurgical.com](http://symmetrysurgical.com)

### MAILING ADDRESS

Symmetry Surgical  
Attn: Customer Service  
3034 Owen Drive  
Antioch, TN 37013

# The Surgical Instrument Desk Reference

## International Customer Service

### PHONE

Symmetry Surgical Switzerland GmbH  
+41 (0) 52 557 59 00  
(Available Monday through Friday, 7:00-16:00 GMT)

Symmetry Surgical, Inc., USA  
1.615.964.5672  
(Available Monday through Friday, 8:30 AM-6:30 PM EST)

### FAX

Symmetry Surgical Switzerland GmbH  
+41 (0) 52 557 59 99

### EMAIL

customerservice@symmetrysurgical.com  
internationalorders@symmetrysurgical.com

### ONLINE

symmetrysurgical.com

### MAILING ADDRESS

Symmetry Surgical Switzerland GmbH  
Bühlstrasse 27  
CH-8200 Schaffhausen  
Switzerland

Symmetry Surgical, Inc.  
3034 Owen Drive  
Antioch, TN 37013

### INTERNATIONAL PAYMENT TERMS/RETURN GOODS POLICY/INSTRUMENT REPAIR & RESTORE PROGRAM/LITERATURE REQUESTS

Please contact your local distributor. Locate a local distributor contact, International Customer Service at +41 (0) 52 557 59 00 or 1.615.964.5672 (US).

Cardiovascular/Thoracic

Energy

Ear, Nose & Throat

General

Laparoscopic

Neurology

Obesity

OB/GYN

Ophthalmology

Orthopedics & Arthroscopy

Pediatrics

Rectal

Retractors

Spine

Urology

Sterilization Solutions

Alphabetical & Numeric Indexes

EAR, NOSE & THROAT

## Adenotomes (Tonsil & Laryngeal)



71-1010

### Laforce Adenotome

CODE	DESCRIPTION	WIDTH
71-1000	Infant	8.0 mm
71-1010	#0 Child	11 mm
71-1011	#1 Small	12 mm
71-1012	#2 Medium	16 mm
71-1013	#3 Large	18 mm

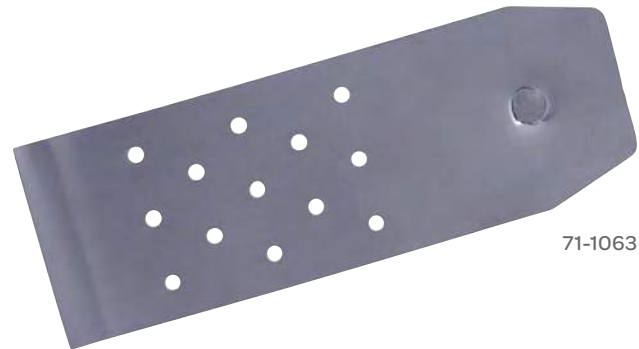

71-1063

### Adenotome Blades

CODE	DESCRIPTION	WIDTH
71-1050	Blade, Infant	8.0 mm
71-1060	Blade #0, Child	11 mm
71-1061	Blade #1, Small	12 mm
71-1062	Blade #2, Medium	16 mm
71-1063	Blade #3 Large	18 mm



## Arch Bars

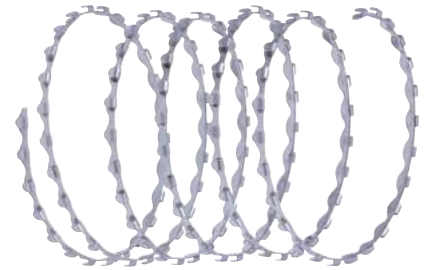

68-1505

### Erich Arch Bar

CODE	DESCRIPTION
68-1505	1 Meter Roll
68-1510	Pack of 12, 5½ in (140 mm) Long

## Awls (Sinus & Nasal)



### Obwegeser Zygomatic Arch Awl

CODE	DESCRIPTION	LENGTH
68-0410	Curved	9½ in 241 mm

## Brushes (Laryngoscope Cleaning)



74-6973

### Laryngoscope Cleaning Brush

CODE	LENGTH
74-6971	10 in 270 mm
74-6972	11 in 280 mm
74-6973	11 in 280 mm

## Calipers (Middle Ear)



### Austin Strut Calipers

CODE	DESCRIPTION	LENGTH
61-0310	Markers at 3.5 mm, 4.0 mm and 4.5 mm From Tip	6 in 150 mm

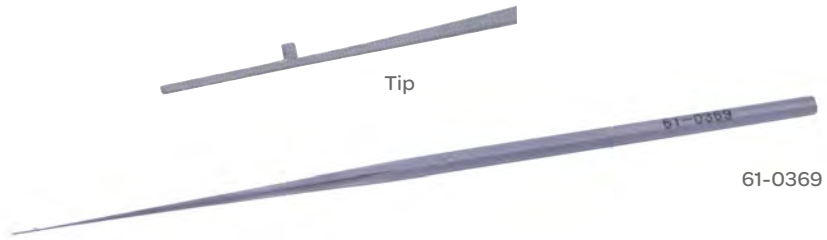

### House Strut Calipers

CODE	DESCRIPTION	LENGTH
61-0367	Marker 3.5 mm From Tip	6 ½ in 165 mm
61-0368	Marker 4.0 mm From Tip	6 ½ in 165 mm
61-0369	Marker 4.5 mm From Tip	6 ½ in 165 mm

## Cannulas (Sinus & Nasal, Sinus, Sinus Suction Cannula)

### Killian Antrum Cannula

CODE	DESCRIPTION	LENGTH
66-6022	3.5 mm Tip	6 in 150 mm



## Cannulas (Sinus & Nasal, Sinus, Sinus Suction Cannula)

### Van Alyea Sinus Cannula

CODE	DESCRIPTION	LENGTH
66-6042	2.0 mm, Slight Curve	6 in 150 mm



### Sinus Suction Cannula

CODE	DESCRIPTION	LENGTH
63-7567	2.5 mm Short Curve	5 3/4 in 145 mm
63-7562	3.0 mm Short Curve	5 3/4 in 145 mm
63-7564	4.0 mm Short Curve	5 3/4 in 145 mm
63-7566	2.5 mm Long Curve	5 3/4 in 145 mm
63-7560	3.0 mm Long Curve	5 3/4 in 145 mm
63-7565	4.0 mm Long Curve	5 3/4 in 145 mm



## Cannulas (Trocar and Cannula)

### Sinuscopy Trocar and Cannula

CODE	TIP SIZE	LENGTH
09-5228	3.5 mm	6 3/4 in 170 mm
09-5229	5.0 mm	6 3/4 in 170 mm

## Chisels (Middle Ear, Sinus & Nasal)

### Austin Chisel

CODE	DESCRIPTION	TIP WIDTH	LENGTH
61-0311	Straight	1.0 mm	6 1/4 in 160 mm





## Chisels (Middle Ear, Sinus & Nasal)

### Ballenger Chisel

V-Shaped Edge



63-0091

CODE	DESCRIPTION	LENGTH
63-0088	2 mm Wide	6¼ in 160 mm
63-0089	4 mm Wide	6¼ in 160 mm
63-0090	6 mm Wide	6¼ in 160 mm
63-0091	8 mm Wide	6¼ in 160 mm

### Cottle Chisel

with Centimeter Markings at 40 mm, 60 mm and 70 mm

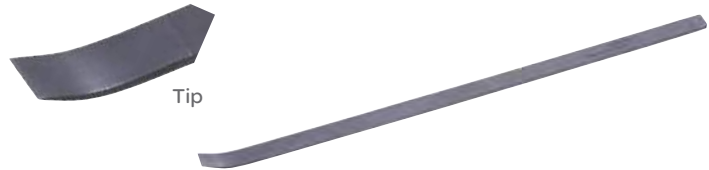

Tip

CODE	DESCRIPTION	LENGTH
63-0110	Curved	7¼ in 185 mm

### Chisel

CODE	DESCRIPTION	LENGTH
68-0404	Single Bevel, 4 mm Tip, Round Handle	6¾ in 170 mm



### Freer Chisel

CODE	DESCRIPTION	LENGTH
63-0084	Straight, 5 mm Wide	6¾ in 170 mm
63-0085	Curved, 5 mm Wide	6¾ in 170 mm



63-0084

## Clamps (Sinus & Nasal, Middle Ear)



### Cottle Columella Clamp

CODE	DESCRIPTION	JAW WIDTH	LENGTH
67-5860	With Adjusting Screw	14 mm	4 3/8 in 110 mm



Tip



### Derlacki Ossicle Holding Clamp

CODE	DESCRIPTION	VERTICAL GROOVE	HORIZONTAL GROOVE	LENGTH
61-0511	1.0 mm Teeth	1.5 x 4 mm	1.5 x 2 mm	4 3/4 in 120 mm



Tip



### Sheehy Ossicle Holding Clamp

CODE	DESCRIPTION	VERTICAL GROOVE	LENGTH
61-0512	5 mm Teeth	1.5 x 4 mm	4 3/4 in 120 mm

## Connectors (Middle Ear)



### House Cut-Off Adapter

CODE	DESCRIPTION	LENGTH
61-1045	for Use with Rosen Suction	2 in 50 mm

## Containers (Tray, Middle Ear)

### Metapak Tray

Stainless Steel

CODE	DESCRIPTION	HEIGHT	
7322-03-200S	Half Length Tray	2 in	50 mm
7310-03-200A	Full Length Tray	2 in	50 mm



### Paparella Instrument Rack

61-3835

CODE	DESCRIPTION
61-3835	Holds up to 20 Instruments, for Tympanoplasty and Stapes Instruments

## Crushers (Cartilage)



67-1970

### Cottle Cartilage Crusher

CODE	DESCRIPTION
67-1970	Cartilage Crusher

## Curettes (Adenoid)



71-3610

### Barnhill Adenoid Curette

CODE	SIZE	BLADE	LENGTH	
71-3610	0	10 mm	8 ¾ in	220 mm
71-3612	1	12 mm	8 ¾ in	220 mm
71-3614	2	14 mm	8 ¾ in	220 mm
71-3616	3	16 mm	8 ¾ in	220 mm
71-3618	4	18 mm	8 ¾ in	220 mm
71-3810	0	10 mm, Reverse Curve	8 ½ in	215 mm
71-3812	1	12 mm, Reverse Curve	8 ½ in	215 mm
71-3814	2	14 mm, Reverse Curve	8 ½ in	215 mm
71-3816	3	16 mm, Reverse Curve	8 ½ in	215 mm
71-3818	4	18 mm, Reverse Curve	8 ½ in	215 mm

## Curettes (Adenoid)

### Jones Adenoid Curette

CODE	DESCRIPTION	BLADE SIZE	LENGTH	
71-3800	Infant Size	4 mm	8 ¾ in	220 mm
71-3801	Child	6 mm	8 ¾ in	220 mm
71-3802	Adult	8 mm	8 ¾ in	220 mm

### Middleton Adenoid Curette

CODE	DESCRIPTION	BLADE SIZE	LENGTH	
71-3209	Infant Size	8 mm	8 ¾ in	220 mm

## Curettes (Adenoid)



### Stubbs Adenoid Curette

CODE	DESCRIPTION	BLADE	LENGTH
71-4111	Infant Size	4 mm	8 ¾ in 220 mm
71-4113	Child	6 mm	8 ¾ in 220 mm
71-4115	Adult	8 mm	8 ¾ in 220 mm

### Vogel Adenoid Curette

CODE	DESCRIPTION	BLADE	LENGTH
71-3208	Infant Size	7 mm Wide	8 ½ in 215 mm

## Curettes (Bone)



### Lempert Bone Curette

Oval, Straight, Delicate

CODE	TIP	LENGTH
29-6706	#6/0	8 in 200 mm
29-6715	#5/0	8 in 200 mm
29-6724	#4/0	8 in 200 mm
29-6733	#3/0	8 in 200 mm
29-6742	#2/0	8 in 200 mm
29-6750	#0	8 in 200 mm
29-6751	#1	8 in 200 mm
29-6752	#2	8 in 200 mm

## Curettes (Double-Ended, Ear)

### Lucas Curette



68-0004

CODE	SIZE	LENGTH
68-0004	#5	7 in 175 mm

### Exodontia Oral Double-Ended Curette



68-0225

CODE	TIP	LENGTH
68-0225	#10	7¼ in 185 mm
68-0227	#12	7¼ in 185 mm
68-0228	#13	7¼ in 185 mm

### Buck Ear Curette



29-6750

CODE	SIZE	TIP	DIAMETER	LENGTH
62-1309	#00	Blunt, Slightly Angled Tip	1.0 mm	6 in 150 mm
62-1310	#0	Blunt, Slightly Angled Tip	1.5 mm	6 in 150 mm
62-1311	#1	Blunt, Slightly Angled Tip	2.0 mm	6 in 150 mm
62-1312	#2	Blunt, Slightly Angled Tip	2.5 mm	6 in 150 mm
62-1313	#3	Blunt, Slightly Angled Tip	3.0 mm	6 in 150 mm
62-1209	#00	Sharp, Slightly Angled Tip	1.0 mm	6 in 150 mm
62-1210	#0	Sharp, Slightly Angled Tip	1.0 mm	6 in 150 mm
62-1211	#1	Sharp, Slightly Angled Tip	2.0 mm	6 in 150 mm
62-1212	#2	Sharp, Slightly Angled Tip	2.5 mm	6 in 150 mm
62-1213	#3	Sharp, Slightly Angled Tip	3.0 mm	6 in 150 mm



## Curettes (Ear)

62-1432



### Shapleigh Ear Curette

CODE	DESCRIPTION	BLADE	LENGTH
62-1431	Small, Very Delicate	1.5 mm Serrated Loop	6 ½ in 165 mm
62-1432	Large, Very Delicate	2 mm Serrated Loop	6 ½ in 265 mm

## Curettes (Ear, Elevator & Curette, Ear)

62-1470



### Gross Ear Spoon & Hook

CODE	DESCRIPTION	LENGTH
62-1470	Double-Ended	4 ¾ in 120 mm

63-0409



### Dunning Elevator & Curette

CODE	SIZE
63-0409	Sharp End 3 x 5 mm, Spatula End 3 mm

61-0015



### Sprague Ear Curette

CODE	SIZE	TIP	LENGTH
61-0015	Small	2 mm	7 in 175 mm
61-0016	Large	3 mm	7 in 175 mm

## Curettes (Frontal Sinus)

### Frontal Sinus Curette

Small Oblong



63-8810

CODE	DESCRIPTION	CUP SIZE	LENGTH
63-8805	Straight	2x5 mm	7½ in 190 mm
63-8810	45° Angle	2x5 mm	7½ in 190 mm
63-8815	90° Angle	2x5 mm	7½ in 190 mm

### Access Frontal Sinus Curette

With Swivel Luer



11-601

CODE	DESCRIPTION	ANGLE
11-601	Frontal Sinus	0°
11-651	Frontal Sinus	50°
11-691	Frontal Sinus	90°

### Access Suction Curette



11-642S

CODE	DESCRIPTION
11-642S	45°
11-692S	90°

## Curettes (Middle Ear)

### Ethmoid Curette

CODE	DESCRIPTION	SIZE	LENGTH
63-0058	Curette	3 x 5 mm Cup	8 in 200 mm



### Guilford-Wright Micro Curette

CODE	DESCRIPTION	ANGLE	CUP	LENGTH
61-0327	Small	Light Angle	1 mm Cup	5 ½ in 140 mm
61-0328	Medium	Light Angle	1.5 mm Cup	5 ½ in 140 mm
61-0329	Large	Strong Angle	2 mm Cup	5 ½ in 140 mm



61-0348

### Hough Curette

CODE	DESCRIPTION	SIZE	LENGTH
61-0348	Angled 35°, Serrated Cup	2 x 3 mm	5 ½ in 140 mm

## Curettes (Middle Ear)



61-0398

### Halle Hough Curette

CODE	DESCRIPTION	SIZE	LENGTH	
61-0398	Lightly Angled	2 x 2.5 mm Cups	6 ½ in	165 mm
61-0399	Strongly Angled	2 x 2.5 mm Cups	6 ½ in	165 mm
61-0398E	Ebonized	2 x 2.5 mm Cups	6 ½ in	165 mm

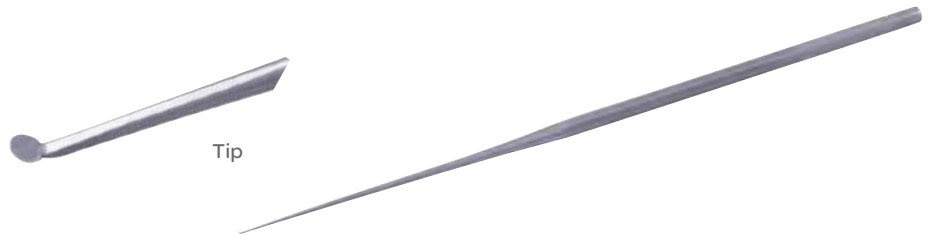

Tip

### House-Sheehy Knife Curette

Malleable Shaft

CODE	DESCRIPTION	BLADE	LENGTH	
61-0381	"Small Weapon"	2 mm	6 ½ in	165 mm
61-0382	"Large Weapon"	2.5 mm	6 ½ in	165 mm



### House Stapes Curette

CODE	DESCRIPTION	SIZE	LENGTH	
61-0380	Double-Ended	1.7 mm and 2 mm	6 in	150 mm

## Curettes (Middle Ear)



### House Stapes Curette

CODE	DESCRIPTION	SIZE
61-3725	Double-Ended, Strong Angle	1.7 mm and 1.9 mm



61-3775

### Paparella Ring Curette

CODE	DESCRIPTION	TIP	LENGTH
61-3775	Angled, Blunt	1.5 mm	6½ in 165 mm

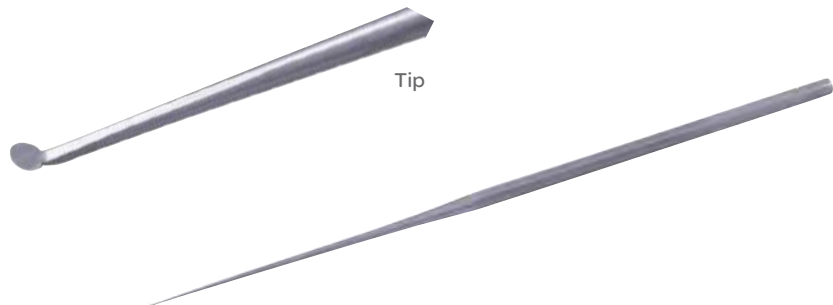

Tip

### Rosen Knife Curette

CODE	DESCRIPTION	ANGLE	BLADE	LENGTH
61-0450	Small	Angled 45°	2 mm	6¼ in 160 mm
61-0451	Large	Angled 45°	2.5 mm	6¼ in 160 mm

## Curettes (Sinus & Nasal)

### Antrum Curette

Fenestrated Cup

CODE	DESCRIPTION	SIZE	LENGTH
63-7540	Backward Cut	7 x 10 mm Tip	7 ½ in 190 mm
63-7535	Forward Cut	7 x 10 mm Tip	7 ½ in 190 mm

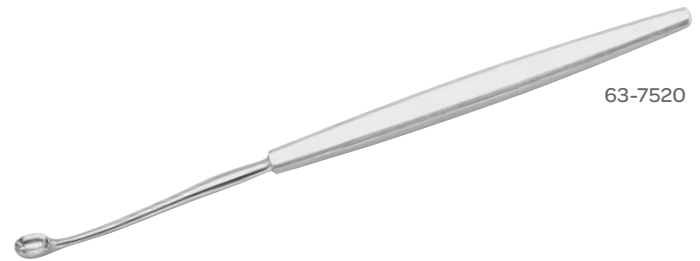

63-7520

### Antrum Curette

CODE	DESCRIPTION	CUP	LENGTH
63-7512	Straight	3 x 9 mm	7 ½ in 190 mm
63-7505	Straight	7 x 11 mm	7 ½ in 190 mm
63-7515	Straight	8 x 11 mm	7 ½ in 190 mm
63-7520	Straight	9 x 13 mm	7 ½ in 190 mm
63-7510	Angled Up	1.5 x 6 mm	7 ½ in 190 mm



66-5801

### Coakley Antrum Curette

Single-Ended

CODE	DESCRIPTION	LENGTH
66-5801	#1	6 ¾ in 170 mm
66-5802	#2	6 ¾ in 170 mm
66-5803	#3	6 ¾ in 170 mm
66-5804	#4	6 ¾ in 170 mm
66-5805	#5	6 ¾ in 170 mm
66-5806	#6	6 ¾ in 170 mm



## Curettes (Sinus & Nasal)



### Faulkner Antrum Curette

Double-Ended, Malleable Shaft

CODE	DESCRIPTION	LENGTH
63-7500	5 mm and 8 mm Rings	9 in 230 mm

## Cutting Blocks

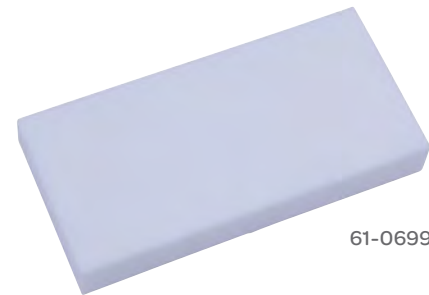

61-0699

### Cutting Block

CODE	DESCRIPTION	WIDTH	LENGTH
61-0699	Teflon Cutting Block	1½ in 38 mm	3 in 76 mm

## Dilators (Tracheal)



25-4002

### Laborde Tracheal Dilator

CODE	DESCRIPTION	BLADES	JAW WIDTH	JAW THICKNESS	LENGTH
25-4002	Tri-Valve		$\frac{3}{16}$ in 5.0 mm	$\frac{1}{4}$ in 6.0 mm	6¾ in 170 mm
73-6604	Child	Three Blades, Two Flat, One Cupped			6¾ in 170 mm
73-6603	Adult	Three Blades, Two Flat, One Cupped			6¾ in 170 mm

## Dilators (Tracheal)

### Trousseau Tracheal Dilator



CODE	DESCRIPTION	BLADES	JAW WIDTH	JAW THICKNESS	LENGTH
73-6602	Adult	Two Blades, Curved			6 <sup>3</sup> / <sub>4</sub> in 170 mm
73-6601	Child	Two Blades, Curved			6 <sup>3</sup> / <sub>4</sub> in 170 mm
25-4000	Closed	Two Blades, Curved	¼in 6 mm	⅜in 5 mm	6 <sup>3</sup> / <sub>4</sub> in 170 mm
25-5569	Closed	Two Blades, Curved	⅛in 3 mm	⅛in 3 mm	6 <sup>3</sup> / <sub>4</sub> in 170 mm

## Dissectors (Facial)

### McCabe Facial Nerve Dissector



CODE	DESCRIPTION	JAW LENGTH	LENGTH
62-1585	Smooth Angled Jaws	14 mm	5½in 140 mm

### McCabe Flap Knife Dissector

Double-Ended

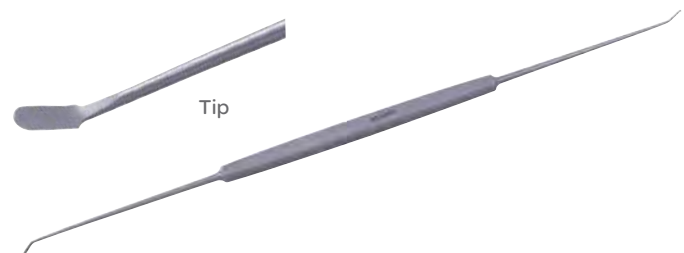

CODE	DESCRIPTION	BLADE	LENGTH
62-0480	Angled 25° and 45°	2 x 3 mm	7½in 185 mm

## Elevators (Mastoid Hook & Searcher)



Tip

### Allport Mastoid Hook & Searcher

CODE	DESCRIPTION	LENGTH
62-1520	Angled 90°	6¼ in 160 mm

## Elevators (Middle Ear, Cleft Palate, Ball End)



Tip

### Jordan Canal Elevator

CODE	DESCRIPTION	LENGTH
61-0416	2 mm Sharp Blade, Angled 60°	6½ in 165 mm



### Blair Cleft Palate Elevator

CODE	DESCRIPTION	TIP	LENGTH
67-1749	Blair Cleft	L-Shaped	7½ in 190 mm

## Elevators (Middle Ear, Cleft Palate, Ball End)

### Cronin Cleft Palate Elevator



CODE	DESCRIPTION	TIP	LENGTH
67-1750	Small	4 x 9 mm	6¼ in 160 mm

### Ball End Elevator



CODE	DESCRIPTION	LENGTH
66-5490	Curved	7½ in 190 mm

### Austin Elevator



CODE	DESCRIPTION	TIP	LENGTH
61-0302	Knife Elevator, Angled 90°	2 mm Round	6¼ in 160 mm

## Elevators (Middle Ear)



### Guilford-Wright Drum Elevator

CODE	DESCRIPTION	TIP WIDTH	LENGTH
61-0323	Elevator	2 mm	5½ in 140 mm

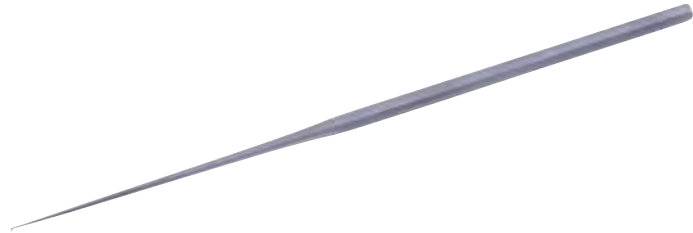

### Paparella Drum Elevator

Double-Ended

CODE	DESCRIPTION	LENGTH
61-3710	Elevator Knife, #3	7¼ in 185 mm



### House Bayonet Elevator & Chisel

CODE	DESCRIPTION	TIP WIDTH	LENGTH
61-0394	Curved	1 mm	6¾ in 170 mm

## Elevators (Middle Ear)



### Paparella Duckbill Elevator

CODE	DESCRIPTION	LENGTH
61-0440	3.5 mm Curved Blade	6½ in 165 mm



### House "Gimmick" Elevator

CODE	DESCRIPTION	TIP	LENGTH
61-0376	15° Angle	1 x 12 mm	6½ in 165 mm

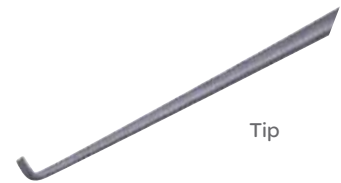

### Hough "Hoe" Elevator

CODE	DESCRIPTION	TIP	LENGTH
61-0340	Angled Shaft, 90° Tip Angle	0.5 mm	6 in 150 mm

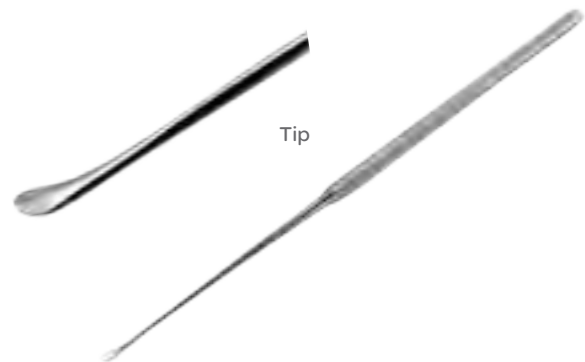

### Austin Duckbill Knife Elevator

CODE	DESCRIPTION	TIP	LENGTH
61-0301	Curved Tip	2 x 8 mm	6¼ in 160 mm



## Elevators (Middle Ear, Nasal)

### Tabb Elevator

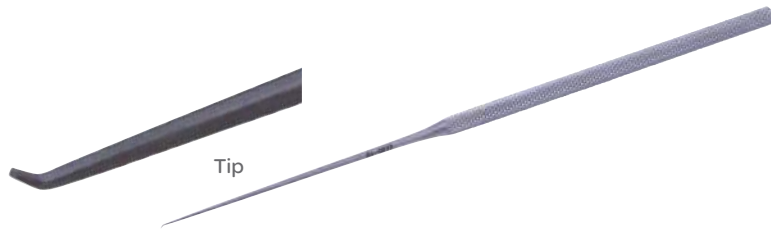

CODE	DESCRIPTION	BLADE	LENGTH
61-0272	45° Angle	1 mm	6½ in 165 mm

## Elevators (Middle Ear, Nasal)

### Boies Nasal Fracture Elevator



CODE	DESCRIPTION	TIP WIDTH	LENGTH
67-1570	Heavy Shaft, Blunt Edges	9 mm	7¾ in 195 mm

### Freer Elevator



CODE	DESCRIPTION	TIP	LENGTH
55-7026	4.5 mm, Double-Ended	1 mm	7½ in 190 mm
55-7027	6.5 mm, Double-Ended	1 mm	7½ in 190 mm

## Elevators (Periosteal, Septal, Skin)

### Dingman Periosteal Elevator

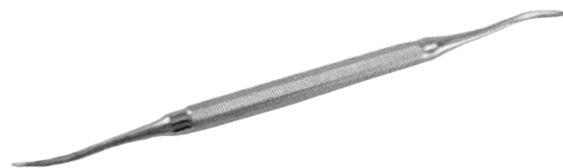

CODE	DESCRIPTION	LENGTH
68-0905	Double-Ended	7¼ in 185 mm

## Elevators (Periosteal, Septal, Skin)



26-4224

### McKenty Periosteal Elevator

CODE	DESCRIPTION	TIP	LENGTH
26-4224	Light Curve	4 mm Wide	6 in 150 mm
26-4225	Light Curve	5 mm Wide	6 in 150 mm



### Molt Periosteal Elevator

CODE	DESCRIPTION	LENGTH
26-3703	Sharp/Blunt, Double-Ended	7 1/8 in 180 mm
26-3707	Sharp/Sharp, Double-Ended	7 1/8 in 180 mm

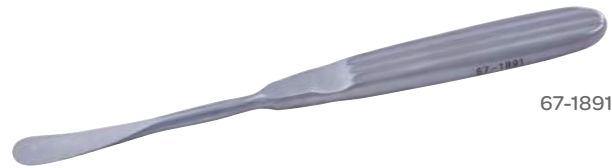

67-1891

### Obwegeser Periosteal Elevator

CODE	DESCRIPTION	TIP	LENGTH
67-1890	Elevator	7 mm Wide	7 in 175 mm
67-1891	Elevator	11 mm Wide	7 in 175 mm

### Seldin Periosteal Elevator

CODE	DESCRIPTION	LENGTH
68-0393	#23, Flat Handle	7 3/4 in 197 mm

## Elevators (Septal)

### Cottle Septum Elevator



CODE	DESCRIPTION	LENGTH
67-1623	Double-Ended with Graduations	8 <sup>3</sup> / <sub>4</sub> in 220 mm

### Goldman Septum Elevator

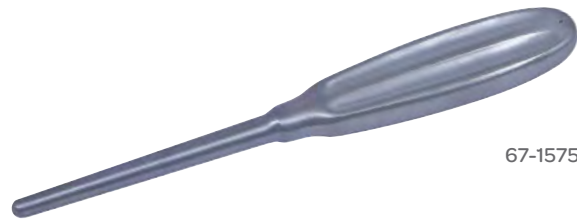

67-1575

CODE	DESCRIPTION	LENGTH
67-1575	Heavy Tapered Blade	7 <sup>1</sup> / <sub>2</sub> in 190 mm

### Tebbets Septal Elevator



CODE	DESCRIPTION	LENGTH
67-1770	Elevator	8 <sup>1</sup> / <sub>4</sub> in 210 mm

## Elevators (Skin)

### Cottle Skin Elevator



67-1550

CODE	DESCRIPTION	LENGTH
67-1551	Blunt	7 <sup>1</sup> / <sub>2</sub> in 190 mm
67-1550	Sharp	7 <sup>1</sup> / <sub>2</sub> in 190 mm

## Elevators (Zygoma)



### Gillies Zygoma Elevator

CODE	TIP WIDTH	FROM ANGLE TO TIP	LENGTH
68-4510	9 mm	35 mm	9 in 230 mm

### Alderdyce Elevator

CODE	DESCRIPTION	WIDTH	LENGTH
72-2530	Double-Ended, Sharp/Blunt	8 mm	8½ in 215 mm

### Dingman Elevator

CODE	DESCRIPTION	LENGTH
68-0920	Curved	8¼ in 210 mm

### Exodontia Elevator

CODE	DESCRIPTION	LENGTH
68-0298	#34S	6 in 150 mm

## Elevators (Zygoma)

### Hajek Ballenger Elevator

Double-Ended



CODE	DESCRIPTION	TIP	LENGTH
66-5430	Blunt, Semi-Sharp, Heavy	5 mm	7 <sup>3</sup> / <sub>4</sub> in 197 mm



### Lempert Elevator

CODE	DESCRIPTION	TIP	LENGTH
61-0514	Solid Handle, Curved Tip	7 mm	7 <sup>1</sup> / <sub>4</sub> in 185 mm



### Lempert Elevator

CODE	DESCRIPTION	TIP	LENGTH
63-0401	Small with Slight Curve	2 mm	6 <sup>3</sup> / <sub>4</sub> in 170 mm
63-0402	Small with Slight Curve	3 mm	6 <sup>3</sup> / <sub>4</sub> in 170 mm

### McCulloch Elevator

CODE	DESCRIPTION	TIP	LENGTH
66-6500	Semi-sharp	3 mm	7 <sup>1</sup> / <sub>2</sub> in 190 mm



## Elevators (Zygoma)



## Pennington Elevator

CODE	DESCRIPTION	TIPS	LENGTH
66-5450	Double-Ended	6 x 9 mm and 6 x 11 mm	8½ in 215 mm

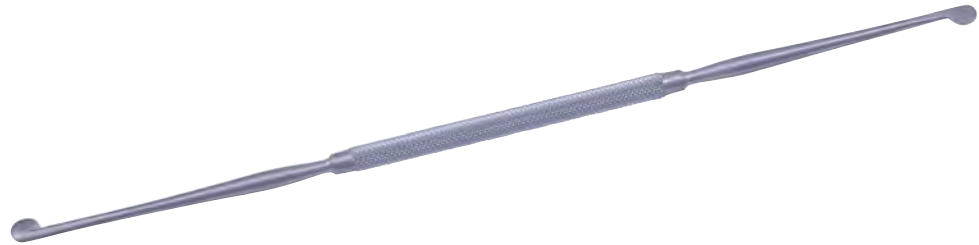

## Pierce Elevator

CODE	DESCRIPTION	LENGTH
66-5455	Double-Ended, Right and Left Blade	7½ in 190 mm



## Rogers Elevator

CODE	DESCRIPTION	LENGTH
66-5500	Curved, Double-Ended, Semi-Sharp Blades	8¼ in 210 mm

## Energy (Energy Accessories)



### Bipolar Cords

Reusable, Sold Individually

87006

CODE	DESCRIPTION	PLUG	LENGTH
87006	Shrouded Instrument Connector	Fixed-Pin Generator	12 ft 3.6 m
87110	European Flat Instrument Connector	Fixed-Pin Generator	12 ft 3.6 m
50-1106	45° Angled Instrument Connector	Fixed-Pin Generator	12 ft 3.6 m
87600	Bicomatic Instrument Connector	Wolf-Style Generator	12 ft 3.6 m



### Bipolar Cords

Single-Use, 10 per Box, Sterile

40-1105

CODE	DESCRIPTION	PLUG	LENGTH
40-1105	Straight Instrument Connector	Fixed-Pin Generator	12 ft 3.6 m
40-1107	Straight Instrument Connector	Fixed-Pin Generator	12 ft 3.6 m
40-1106	45° Angled Instrument Connector	Fixed-Pin Generator	12 ft 3.6 m
40-1114	Wolf-Style Instrument Connector	Wolf-Style Generator	12 ft 3.6 m
40-1115	Wolf-Style Instrument Connector	Valleylab-Style Generator	12 ft 3.6 m



20003

### Monopolar Cords

Reusable, 1 Each

CODE	DESCRIPTION	PLUG	LENGTH
20002	2.0 mm European-Style Recessed Pin Female	$\frac{5}{32}$ in (4.0 mm) Male Generator	10 ft 3.0 m
20003	TUR/Resectoscope Female	Valleylab-Style Male Generator	10 ft 3.0 m
20006	2.0 mm European-Style Recessed Pin Female	Valleylab-Style Male Generator	10 ft 3.0 m

## Energy (Energy Accessories)



### Monopolar Cords

Reusable, Sold Individually

50-2107

CODE	DESCRIPTION	PLUG	LENGTH
90018	Olsen® Threaded Instrument Connector	5/32 in (4.0 mm) Male Generator	10 ft 3.0 m
90020	Olsen® Threaded Instrument Connector	Valleylab-Style Male Generator	10 ft 3.0 m
90054	Laparoscopic Instrument Connector	5/32 in (4.0 mm) Male Generator	10 ft 3.0 m
90056	Laparoscopic Instrument Connector	Valleylab-Style Male Generator	10 ft 3.0 m
90065	Snare Female	5/32 in (4.0 mm) Male Generator	10 ft 3.0 m
90067	3.0 mm Olympus-Style Snare Connector	Valleylab-Style Male Generator	10 ft 3.0 m
50-2107	Endoscopic Instrument Connector, Angled 90°	Valleylab-Style Male Generator	10 ft 3.0 m
50-2111	Endoscopic Instrument Connector, Straight	Valleylab-Style Male Generator	10 ft 3.0 m



### Monopolar Cords

Single-Use, 10 per Box, Sterile

40-2106

CODE	DESCRIPTION	PLUG	LENGTH
40-2110	Endoscopic Instrument Connector, Straight	Valleylab-Style Generator	10 ft 3.0 m
40-2106	Endoscopic Instrument Connector, Angled 90°	Valleylab-Style Generator	10 ft 3.0 m

### Anesthesia Circuit Shield

Laser Safety Product, 6 per Box

CODE	DESCRIPTION	SIZE
60-7100	Laser Safety Product	12 x 48 in 30.5 x 122 mm



## Energy (Energy Accessories)



77005

### Holster Electrosurgical Accessory

Single-Use, 50 per Box, Sterile

CODE	DESCRIPTION
77005	with Metal Clip
77006	with Tip Cleaner and Metal Clip
77000	with Tip Cleaner
77001	



### Binocular Eye Shield

Single-Use, Laser Safety Product

CODE	DESCRIPTION	QTY
60-7000-OL	Eye Shield	12/Box

### Personnel Shield

Single-Use, Drapes Between Sterile Field and Anesthesiologist, 6 per Box

CODE	DESCRIPTION	SIZE
60-7200	Drapes Between Sterile Field and Anesthesiologist	30 x 60 in 762 x 1524 mm

## Energy (Energy Accessories)



97500

### ProClean™ Tip Cleaning Pad with Adhesive Back

Single-Use, Sterile

CODE	DESCRIPTION	QTY
97500	with Adhesive Back Electrosurgical Accessory	50/Box
97501	with Adhesive Back Electrosurgical Accessory	144/ Box

## Energy (Monopolar Adapters, Electrode)



96000

### Monopolar Generator Adapter

Electrosurgical Accessory, Male, Reusable, Sold Individually

CODE	DESCRIPTION	WIRE
96000	$\frac{5}{32}$ in (4.0 mm)	Crimped Wire $\frac{1}{8}$ in (3.2 mm) Female
96001	Valleylab-Style	Crimped Wire $\frac{1}{8}$ in (3.2 mm) Female
96200	Valleylab-Style	European/Wolf-Style Female

EAR, NOSE & THROAT



68600

### Nasal Needle Electrode

Reusable, Sold Individually

CODE	DESCRIPTION	LENGTH
68603	6.0 mm Exposure	8 in 203 mm
68601	15 mm Exposure	8 in 203 mm
68602	50 mm Exposure	8 in 203 mm
68600	102 mm Exposure	8 in 203 mm

## Energy (Bayonet Monopolar Forceps)

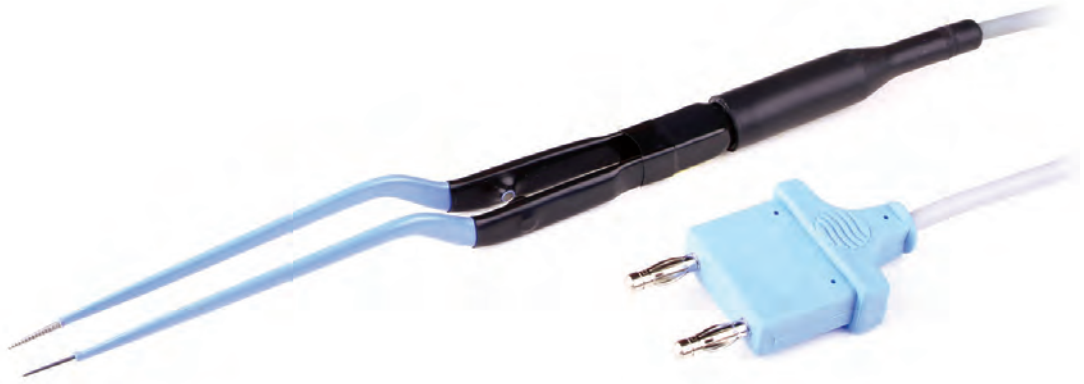

### Bayonet Monopolar Forceps, Hand-Controlled

Reusable, Serrated Tips, Insulated with 10 ft (3.0 m) Attached Cord, 1 Each

Length (L)	6½ in 165 mm	8¼ in 210 mm	7½ in 191 mm	7½ in 191 mm
Working (WL)	3¼ in 83 mm	7½ in 191 mm	3¾ in 95 mm	3¾ in 950 mm
<b>TIP SIZE</b>	<b>SERRATED TIP</b>	<b>SERRATED TIP</b>	<b>STRAIGHT</b>	<b>CATHEDRAL</b>
0.5 mm	11104	11605	11206	11213
1.0 mm	11102	11604	11205	11212
1.5 mm	11101	11602	11204	11210
2.0 mm	11100	11600	11200	11208

## Energy (Reusable Bipolar Forceps)



10-1445I

### Bayonet Bipolar Forceps, Angled Up

Reusable, Smooth Tips, 1 Each

Length (L)	8¼ in 210 mm	10½ in 267 mm	8¼ in 210 mm	10½ in 267 mm
Working (WL)	4¼ in 108 mm	6¼ in 159 mm	4¼ in 108 mm	6¼ in 159 mm
<b>TIP SIZE</b>	<b>NON-INSULATED</b>	<b>NON-INSULATED</b>	<b>INSULATED</b>	<b>INSULATED</b>
1.0 mm	10-1445	10-1482	10-1445I	10-1482I
1.5 mm	10-1447	10-1486	10-1447I	10-1486I
2.0 mm	10-1449	10-1488	10-1449I	10-1488I

## Energy (Reusable Bipolar Forceps)

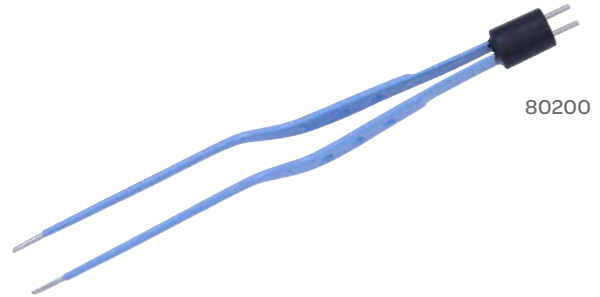

80200

### Bayonet Bipolar Forceps, Insulated

Reusable Smooth Tip, Sold Individually

Length (L)	6½ in 165 mm	7½ in 190 mm	7¾ in 197 mm	8⅝ in 219 mm	12 in 305 mm
Working (WL)	2¾ in 70 mm	3 in 76 mm	3⅝ in 92 mm	4½ in 114 mm	7⅞ in 200 mm

TIP SIZE	INSULATED	INSULATED	INSULATED	INSULATED	INSULATED
micro	80205	80304			
0.5 mm	80204	80303	80434	80574	
0.75 mm			80433	80573	
1.0 mm	80202	80302			80582
1.2 mm			80432	80572	
1.5 mm	80201	80301	80431	80571	80581
2.0 mm	80200	80300	80430	80570	80580

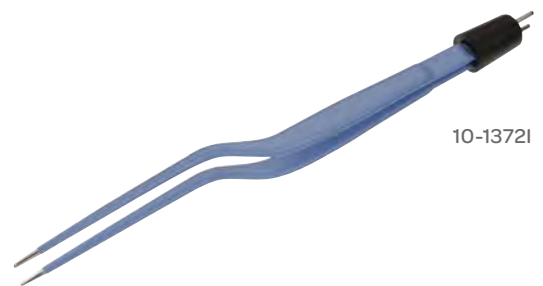

10-1372I

### Bayonet Bipolar Forceps, Insulated

Reusable Smooth Tip, Sold Individually

Length (L)	6¼ in 159 mm	7⅛ in 181 mm	8¼ in 210 mm	10½ in 267 mm
Working (WL)	2¾ in 70 mm	2¾ in 70 mm	4½ in 108 mm	6¼ in 159 mm

TIP SIZE	INSULATED	INSULATED	INSULATED	INSULATED
0.5 mm	10-1311I	10-1360I	10-1421I	10-1483I
0.75 mm	10-1321I	10-1361I	10-1401I	10-1485I
1.0 mm	10-1322I	10-1362I	10-1431I	10-1481I
1.5 mm	10-1331I	10-1371I	10-1411I	10-1484I
2.0 mm		10-1372I	10-1412I	10-1487I

## Energy (Reusable Bipolar Forceps)

### Gerald Bipolar Forceps

Reusable, Smooth Tips, 1 Each

CODE	DESCRIPTION	TIP SIZE	LENGTH
10-1180I	Forceps, Insulated	1.0 mm	7¼ in 184 mm

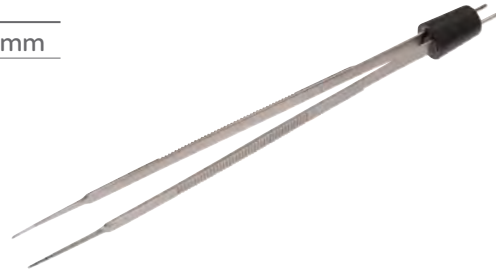

### Cushing Bayonet Bipolar Forceps

Reusable, 1 Each

CODE	DESCRIPTION	TIP SIZE	LENGTH
08-0000I	Forceps, Insulated	0.7 mm	7½ in 191 mm
08-0026I	Forceps, Insulated	1.0 mm	7½ in 191 mm
08-0027I	Forceps, Insulated	1.5 mm	7½ in 191 mm



08-0000

### Cushing Bipolar Forceps

Reusable, Smooth Tips, 1 Each

CODE	DESCRIPTION	TIP SIZE	LENGTH
10-1160I	Forceps, Insulated	1.0 mm	7 in 178 mm
10-1162I	Forceps, Insulated	1.5 mm	7 in 178 mm

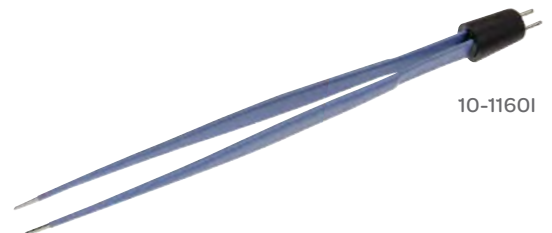

10-1160I

## Energy (Reusable Bayonet Forceps)

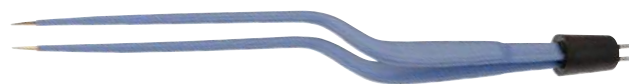

90-7004

### Bayonet Bipolar Forceps, Midas Touch® Non-Stick

Reusable Smooth Tip, Insulated

Length (L)	7 3/4 in 197 mm	8 5/8 in 219 mm	10 1/2 in 267 mm
Working (WL)	3 5/8 in 92 mm	4 3/8 in 111 mm	6 1/4 in 159 mm

TIP SIZE	INSULATED	INSULATED	INSULATED
0.5 mm	90-7004	90-8012	90-9008
0.75 mm	90-7000	90-8000	90-9007
1.2 mm	90-7005	90-8013	90-9006
1.5 mm	90-7001	90-8001	90-9005
2.0 mm	90-7006	90-8003	90-9009



90-8007

### K-Style Standard Angle Bayonet Bipolar Forceps, Curved Up

Reusable, Smooth Tip, Midas Touch® Non-Stick Tips, 1 Each

Length (L)	8 5/8 in 219 mm	9 1/2 in 229 mm	Length (L)	8 5/8 in 219 mm	9 1/2 in 229 mm
Working (WL)	4 1/2 in 114 mm	5 1/8 in 130 mm	Working (WL)	4 1/2 in 114 mm	5 1/8 in 130 mm

TIP SIZE	INSULATED	INSULATED	TIP SIZE	INSULATED	INSULATED
0.5 mm	90-8017	90-9509	0.5 mm		
0.75 mm	90-8018	90-9510	0.75 mm		
1.0 mm	90-8007	90-9502	1.0 mm	90-8009	90-9505



90-8006

### K-Style Standard Angle Bayonet Bipolar Forceps, Straight

Reusable, Smooth Tip, Midas Touch® Non-Stick Tips, 1 Each

Length (L)	8 5/8 in 219 mm	9 1/2 in 229 mm	10 1/2 in 267 mm
Working (WL)	4 1/2 in 114 mm	5 1/8 in 130 mm	6 1/4 in 159 mm

TIP SIZE	INSULATED	INSULATED	INSULATED
0.5 mm	90-8015	90-9507	
0.75 mm	90-8016	90-9508	
1.0 mm	90-8006, 90-8008	90-9501, 90-9504	90-9001
1.5 mm		90-9500	90-9000

## Energy (Reusable Bipolar Forceps)

### Potts-Smith Bipolar Forceps

Reusable, Smooth Tips, 1 Each

CODE	DESCRIPTION	TIP SIZE	LENGTH
80404	Forceps, Insulated	Micro	7¼ in 184 mm
80403	Forceps, Insulated	0.5 mm	7¼ in 184 mm
80402	Forceps, Insulated	1.0 mm	7¼ in 184 mm
80401	Forceps, Insulated	1.5 mm	7¼ in 184 mm
80400	Forceps, Insulated	2.0 mm	7¼ in 184 mm

### Scoville-Greenwood Bayonet Bipolar Forceps

Reusable, 1 Each

CODE	DESCRIPTION	TIP SIZE	LENGTH
08-0030	Forceps, Non-Insulated	1.5 mm	7½ in 191 mm
08-0092	Forceps, Non-Insulated	1.5 mm	7 in 178 mm
08-0028I	Forceps, Insulated	0.25 mm	7¾ in 197 mm
08-0030I	Forceps, Insulated	1.5 mm	7½ in 191 mm

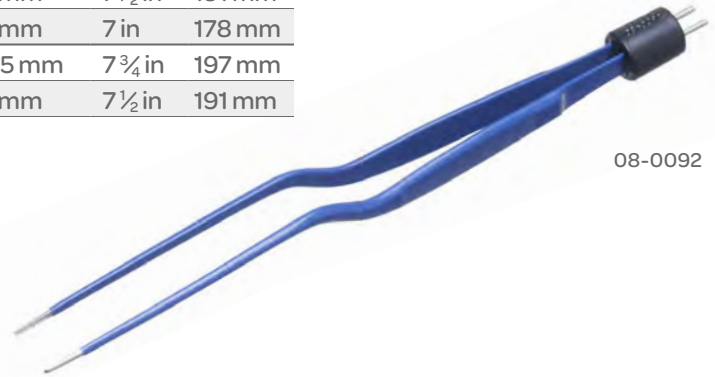

08-0092

### Semkin Bipolar Forceps

Reusable, Smooth Tips, 1 Each

CODE	DESCRIPTION	TIP SIZE	LENGTH
10-1091I	Forceps, Insulated	0.75 mm	5½ in 140 mm
10-1191I	Forceps, Insulated	1.0 mm	5½ in 140 mm
90-3000	Midas Touch Non-Stick, Insulated	0.75 mm	5¾ in 146 mm

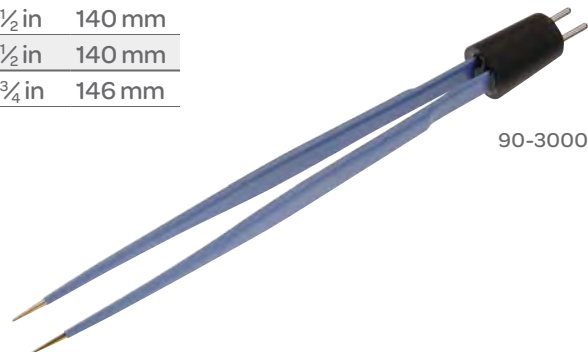

90-3000

## Energy (Single-Use Bipolar Forceps)

### Adson Bipolar Forceps, Smooth Tip

10 per Box

CODE	DESCRIPTION	TIP SIZE	LENGTH	
20-1082I	Forceps, Insulated	1.0 mm	5 in	127 mm
20-1082KI	Kit, Insulated	1.0 mm	5 in	127 mm



90-3000

### Single-Use Bayonet Bipolar Forceps, Acute Angle

Smooth Tips, 10 per Box

Length (L)	7 1/2 in	191 mm	7 1/2 in	191 mm
Working (WL)	4 1/8 in	105 mm	4 1/8 in	105 mm

TIP SIZE	FORCEPS, INSULATED	KIT, INSULATED
0.75 mm	20-1530I	20-1530KI
1.0 mm	20-1540I	
1.5 mm	20-1550I	20-1550KI

### Single-Use Bayonet Bipolar Forceps, Acute Angle

Smooth Tips, 10 per Box

Length (L)	8 3/8 in	213 mm	8 3/8 in	213 mm	8 3/8 in	213 mm	8 3/8 in	21.3 mm
Working (WL)	5 1/8 in	130 mm	5 1/8 in	130 mm	5 1/8 in	130 mm	5 1/8 in	130 mm

TIP SIZE	FORCEPS, NON-INSULATED	FORCEPS, INSULATED	KIT, NON-INSULATED	KIT, INSULATED
0.75 mm				20-1560KI
1.0 mm	20-1570	20-1570I	20-1570K	20-1570KI
1.5 mm	20-1580		20-1580K	



## Energy (Single-Use Bipolar Forceps)



20-1482I

### Single-Use Bayonet Bipolar Forceps, with Midas Touch® Non-Stick Tips

5 per Box

Length (L)	6¼ in 159 mm	7½ in 191 mm
Working (WL)	3¾ in 95 mm	3 in 70 mm

TIP SIZE	INSULATED	INSULATED
0.5 mm	20-1315IMT	20-1386IMT
0.75 mm	20-1320IMT	20-1384IMT
1.0 mm	20-1325IMT	20-1382IMT
1.5 mm	20-1330IMT	20-1380IMT



20-1482I

### Single-Use Bayonet Bipolar Forceps, Angled Up

Smooth Tips, 10 per Box

Length (L)	10½ in 267 mm	10½ in 267 mm
Working (WL)	6 in 152 mm	6 in 152 mm

TIP SIZE	FORCEPS, INSULATED	KIT, INSULATED
1.0 mm	20-1682I	20-1682KI-28



20-1320

### Single-Use Bayonet Bipolar Forceps

Smooth Tips, 10 per Box

Length (L)	6¼ in 159 mm	6¼ in 159 mm	6¼ in 159 mm
Working (WL)	3¾ in 95 mm	3¾ in 95 mm	3¾ in 95 mm

TIP SIZE	FORCEPS, INSULATED	KIT, NON-INSULATED	KIT, INSULATED
0.5 mm	20-1315I	20-1315K	20-1315KI
0.75 mm	20-1320I	20-1320K	20-1320KI
1.0 mm	20-1325I	20-1325K	20-1325KI
1.5 mm	20-1330I	20-1330K	20-1330KI

## Energy (Single-Use Bipolar Forceps)

### Single-Use Bayonet Bipolar Forceps

Smooth Tips, 10 per Box

20-1370



Length (L)	7 1/8 in 181 mm	7 1/8 in 181 mm
Working (WL)	2 3/4 in 70 mm	2 3/4 in 70 mm

TIP SIZE	FORCEPS, INSULATED	KIT, INSULATED
0.5 mm	20-1355I	20-1355KI
0.75 mm	20-1360I	20-1360KI
1.0 mm	20-1340I	20-1340KI
1.5 mm	20-1370I	20-1370KI
2.0 mm	20-1375I	20-1375KI

### Single-Use Bayonet Bipolar Forceps

Smooth Tips, 10 per Box

20-1380I



Length (L)	7 1/2 in 191 mm	7 1/2 in 191 mm
Working (WL)	3 in 76 mm	3 in 76 mm

TIP SIZE	FORCEPS, INSULATED	KIT, INSULATED
0.5 mm	20-1386I	
0.75 mm	20-1384I	
1.0 mm	20-1382I	20-1382KI
1.5 mm	20-1380I	20-1380KI

### Single-Use Bayonet Tonsil Bipolar Forceps

Smooth Tips, Angled Down, Insulated, 10 per Box



Length (L)	7 1/2 in 191 mm	7 1/2 in 191 mm
Working (WL)	3 in 76 mm	3 in 76 mm

TIP SIZE	FORCEPS, INSULATED	KIT, INSULATED
1.5 mm	20-1381I	20-1381KI-28

## Energy (Single-Use Bipolar Forceps)

### Single-Use Gerald Bipolar Forceps

Smooth Tips, 10 per Box

CODE	DESCRIPTION	TIP SIZE	LENGTH
20-1180	Forceps, Non-Insulated	1.0 mm	7¼ in 184 mm
20-1180I	Forceps, Insulated	1.0 mm	7¼ in 184 mm
20-1180K	Kit, Non-Insulated	1.0 mm	7¼ in 184 mm
20-1180KI	Kit, Insulated	1.0 mm	7¼ in 184 mm

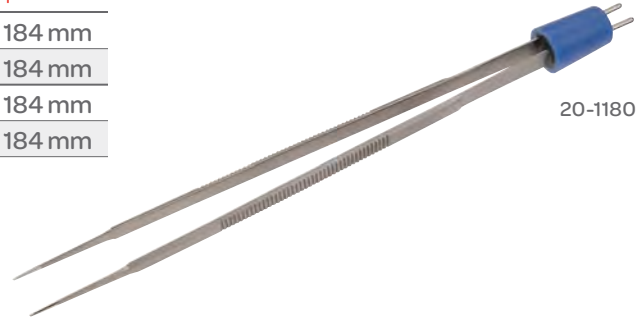

20-1180

### Single-Use Semkin Bipolar Forceps

Smooth Tips, 10 per Box

CODE	DESCRIPTION	TIP SIZE	LENGTH
20-1090I	Forceps, Insulated	0.75 mm	5¾ in 146 mm
20-1190I	Forceps, Insulated	1.0 mm	5½ in 140 mm
20-1090KI	Kit, Insulated	0.75 mm	5¾ in 146 mm
20-1190KI	Kit, Insulated	1.0 mm	5½ in 140 mm



20-1090

### Single-Use Semkin Bipolar Forceps

Midas Touch® Non-Stick, 5 per Box

CODE	DESCRIPTION	TIP SIZE	LENGTH
20-1090IMT	Forceps, Insulated	0.75 mm	5¾ in 146 mm



## Excavators (Middle Ear)

### House "Hoe" Excavator

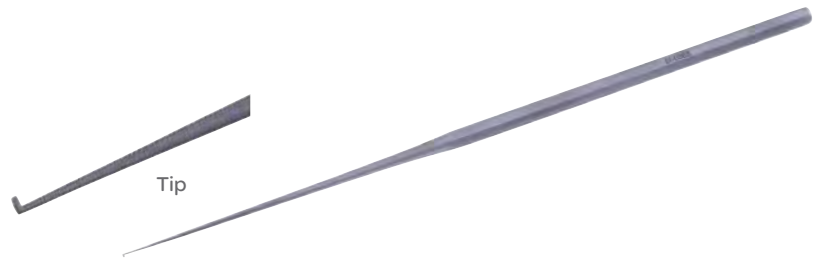

CODE	DESCRIPTION	TIP	LENGTH
61-0363	Straight Shaft, Angled 90°	0.5 mm	6 ½ in 165 mm

### Austin Excavator



CODE	DESCRIPTION	TIP	LENGTH
61-0303	Angled Right	0.75 mm	6 ¼ in 160 mm
61-0304	Angled Left	0.75 mm	6 ¼ in 160 mm

## Foot Plate Hooks (Middle Ear)

### Austin Foot Plate Hook

CODE	DESCRIPTION	TIP WIDTH	LENGTH
61-0319	Angled 90°	0.33 mm	6 ¼ in 160 mm
61-0321	Angled 90°	0.50 mm	6 ¼ in 160 mm

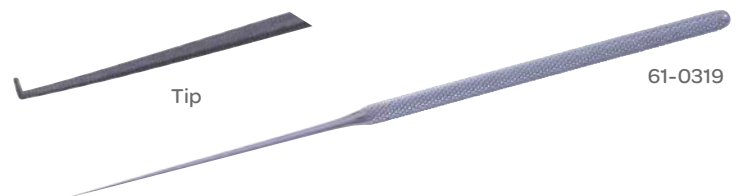

## Forceps (Alligator)

### Bellucci Alligator Forceps

Finely Serrated, 8 mm Jaw

CODE	DESCRIPTION	LENGTH
61-0132	75 mm Shaft	5¼ in 135 mm



### Goodhill Alligator Forceps

CODE	DESCRIPTION	LENGTH
61-0136	75 mm Shaft	5¼ in 135 mm



### Hartmann Alligator Forceps

CODE	DESCRIPTION	LENGTH
61-0127	Serrated Extra Delicate	3½ in 90 mm



## Forceps (Biopsy)

### Biopsy Forceps

Double-Action, 2 x 3 Cups, 9 mm Shaft

CODE	SHAFT	LENGTH
63-5703	Straight	6¼ in 160 mm
63-5701	Curved Up 70°	6¼ in 160 mm
63-5702	Curved Up 110°	6¼ in 160 mm

## Forceps (Biopsy)

### Punch Biopsy Forceps

Single Action Thru-Biting, 1.5 x 3 mm Bite

CODE	DESCRIPTION	LENGTH
63-5706	Straight	7¼ in 185 mm
63-5704	70° Long Curve	7¼ in 185 mm
63-5705	70° Short Curve	7¼ in 185 mm



63-5704

### Roberts Biopsy Forceps

CODE	DESCRIPTION	WORKING LENGTH
74-5936	6 mm Cup	16 in 400 mm

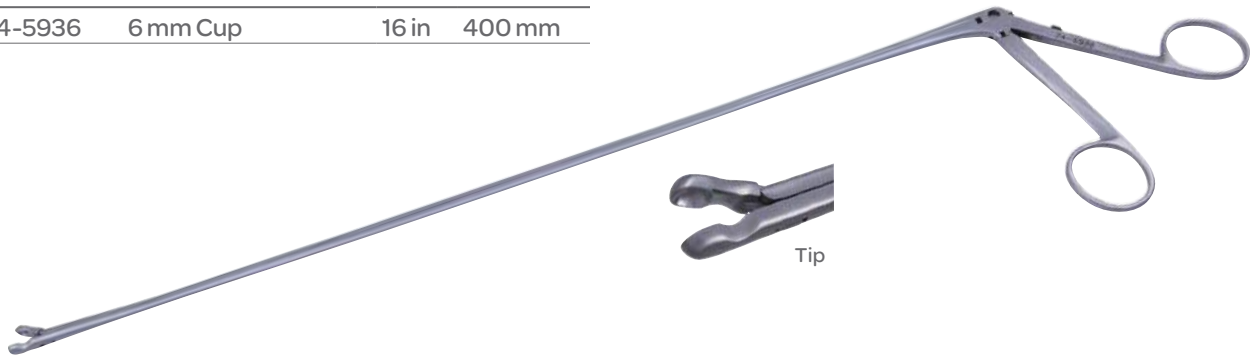

Tip

EAR, NOSE & THROAT

## Forceps (Biting)

### Cottle-Kazanjian Cutting Forceps

Angled

CODE	BLADE	LENGTH
33-0418	29 mm	7⅞ in 180 mm



## Forceps (Crimper)

### Juers Crimper Forceps

75 mm Shaft, Delicate 6 mm Jaws

CODE	JAWS	LENGTH
61-0133	Bayonet Left	5¼ in 135 mm
61-0134	Bayonet Right	5¼ in 135 mm

### Scheer Crimper Forceps

Single Lengthwise Groove in Lower Jaw, 75 mm Shaft

CODE	JAWS	LENGTH
61-0145	5 mm, Smooth	5¼ in 135 mm



## Forceps (Cutting)

### Kleinsasser Cutting Forceps

Heavy Model

CODE	JAWS	WORKING LENGTH	LENGTH
74-6047	2.5 mm Diameter, 5 mm Cup	9 in 230 mm	5¼ in 135 mm

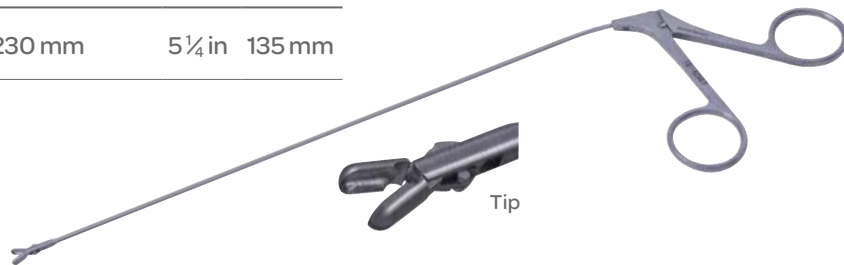

## Forceps (Double-Spoon)

### Double-Spoon Forceps

CODE	DESCRIPTION
66-2599	Pear Jaws, 100°



## Forceps (Double Spoon)

### Giraffe Polyp Forceps

CODE	DESCRIPTION
63-0569	Pear-Shaped, 80°

## Forceps (Dressing)

### Wilde Dressing Forceps

CODE	DESCRIPTION	LENGTH
61-0108	Serrated Tip, Delicate Pattern	5 3/4 in 145 mm



## Forceps (Ear)

### Hartmann Ear Forceps

CODE	DESCRIPTION	JAWS	LENGTH
61-0111	Delicate	3 x 6 mm	5 1/2 in 140 mm

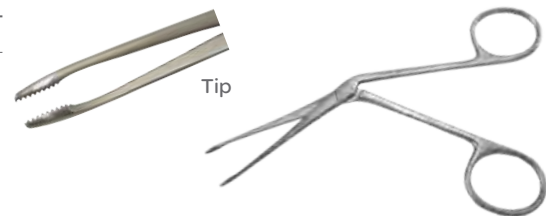

### Hartman-Herzfeld Forceps

CODE	DESCRIPTION	LENGTH
61-0121	2 mm Cup, Straight 6 mm Jaws on 71 mm Shaft	5 1/4 in 135 mm
61-0122	3 mm Cup, Straight 6 mm Jaws on 71 mm Shaft	5 1/4 in 135 mm
61-0123	2 mm Cup, Up Biting on 71 mm Shaft	5 1/4 in 135 mm





## Forceps (Ear)

### Hartmann-Herzfeld Ear Forceps

2mm Cup, Up Biting, 6 mm

CODE	DESCRIPTION	LENGTH
61-0123	71 mm Shaft	5 ¼ in 135 mm
61-0123E	Ebonized	5 ¼ in 135 mm

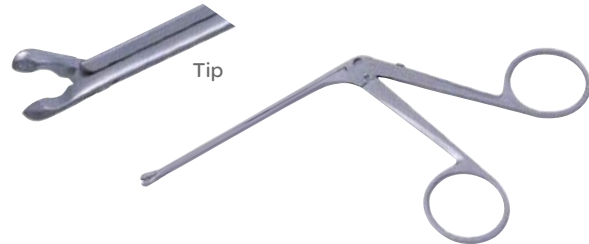

### Hartmann Ear Forceps

Angular, Serrated

CODE	TIP SIZE	LENGTH
30-6951	⅜ in 7.6 mm	3 ½ in 89 mm

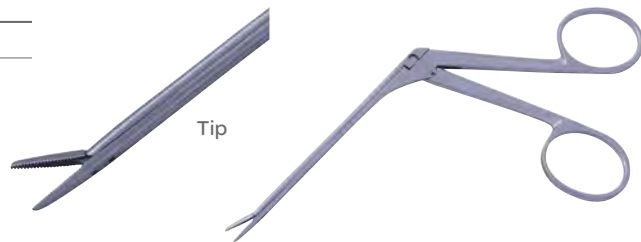

### Lucae Bayonet Dressing Forceps

CODE	DESCRIPTION	LENGTH
07-3074	Serrated, Delicate	5 ¾ in 145 mm

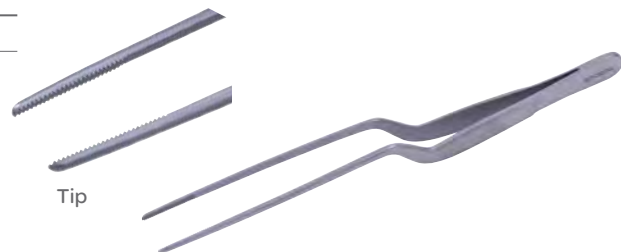

### Lucae Ear Forceps

Bayonet Shape

CODE	WORKING DISTANCE	TIP WIDTH	LENGTH
30-6898	2 ¾ in 70 mm	2 mm	5 ½ in 140 mm

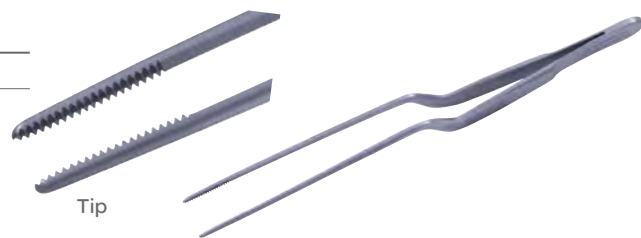

### Noyes Ear Forceps

77 mm Shaft

CODE	JAWS	LENGTH
61-0116	Regular, 6 mm, Serrated	5 ½ in 140 mm
61-0118	Flat, 8 mm, Serrated	5 ¼ in 135 mm



## Forceps (Ear)

### Struempel Ear Forceps

75 mm Shaft, Fenestrated Oval Spoon

CODE	JAWS	LENGTH
61-0120	2.5 x 6 mm	5 1/2 in 140 mm

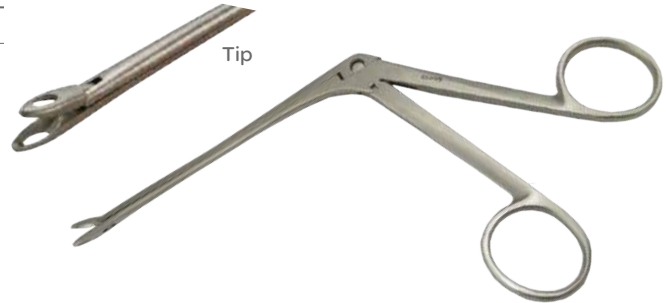

### Tobey Ear Forceps

Very Delicate

CODE	JAWS	LENGTH
61-0113	2 x 4 mm, Serrated	5 1/2 in 140 mm



### Weingartner Ear Forceps

75 mm Shaft

CODE	JAWS	LENGTH
61-0119	3 x 7 mm, Serrated	5 1/4 in 135 mm

## Forceps (Ear Micro)

### Micro Alligator Forceps

Straight

CODE	JAWS	LENGTH
58-4630	3 mm	7 1/4 in 185 mm

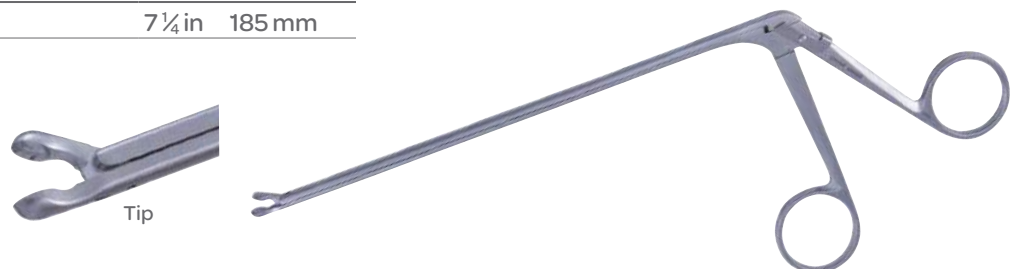

## Forceps (Frontal Sinus)

### Frontal Sinus Giraffe Forceps

Double Action Cupped Forceps

CODE	DESCRIPTION	ANGLES	LENGTH
63-8845	2 mm Jaws	45° Horizontal	5¼ in 135 mm
63-8865	2 mm Jaws	90° Horizontal	5¼ in 135 mm
63-8870	2 mm Jaws	90° Vertical	5¼ in 135 mm
63-8855	3 mm Jaws	45° Horizontal	5¼ in 135 mm
63-8850	3 mm Jaws	45° Vertical	5¼ in 135 mm
63-8875	3 mm Jaws	90° Horizontal	5¼ in 135 mm
63-8880	3 mm Jaws	90° Vertical	5¼ in 135 mm



63-8845

## Forceps (Laryngeal)

### Jackson Laryngeal Forceps

CODE	DESCRIPTION	LENGTH
74-5757	Angled Up, 4 mm Cup	8 in 200 mm



Tip

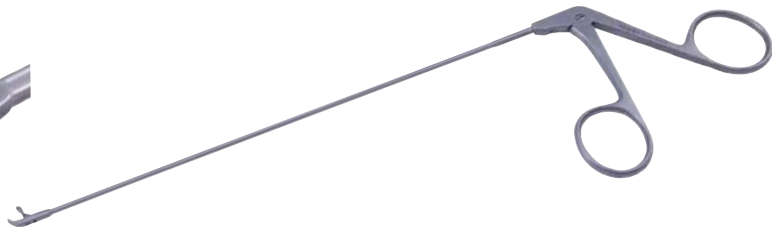

### Jackson Laryngeal Forceps Alligator Forceps

Standard Jaws, Deep Serrations and Grooves

CODE	JAWS	WORKING LENGTH
74-5800	4 x 22 mm	280 mm
74-5801	4 x 22 mm	350 mm



Tip



## Forceps (Cup)

### Jackson Laryngeal Forceps Cup Forceps

Angled Up

CODE	DESCRIPTION	CUP SIZE	WORKING LENGTH
74-5718	Extra Lightweight Construction	2 mm	280 mm
74-5717	Extra Lightweight Construction	2 mm	280 mm
74-5706	Standard	4 mm	280 mm
74-5710	Standard	6 mm	200 mm



Tip

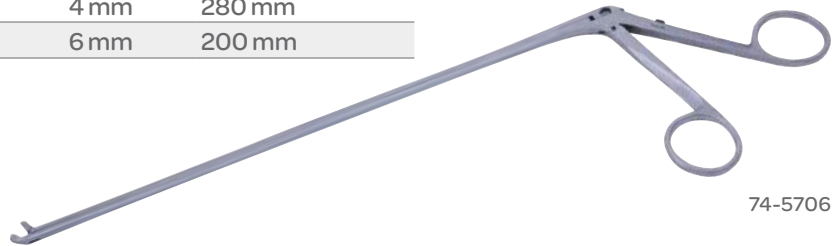

74-5706

### Jackson Laryngeal Forceps Cup Forceps

Straight

CODE	DESCRIPTION	CUP SIZE	WORKING LENGTH
74-5715	Extra Lightweight Construction	2 mm	200 mm
74-5716	Extra Lightweight Construction	2 mm	280 mm
74-5700	Standard	4 mm	280 mm
74-5708	Standard	6 mm	280 mm



Tip

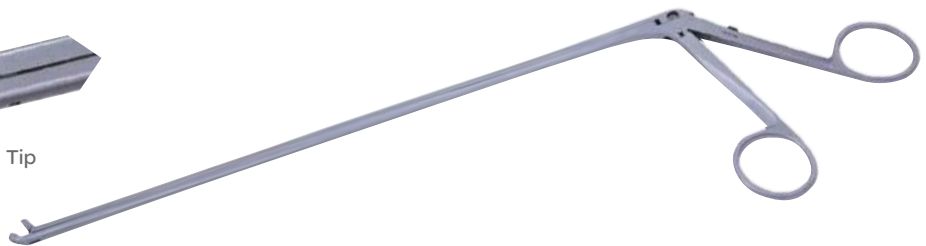

## Forceps (Maxillary)

### Rowe Maxillary Disimpaction Forceps

CODE	DESCRIPTION	LENGTH
68-5001	Left	9½ in 240 mm
68-5002	Right	9½ in 240 mm



68-5002

## Forceps (Cup)

### Jako Micro Laryngeal Cup Forceps

CODE	DESCRIPTION	ROUND CUPS	LENGTH
74-5925	Straight	2 mm	9¼ in 235 mm
74-5926	Curved Left	2 mm	9¼ in 235 mm
74-5927	Curved Right	2 mm	9¼ in 235 mm
74-5928	Curved Up	2 mm	9¼ in 235 mm



74-5926

## Forceps (Micro Laryngeal Cup)

### Jako-Kleinsasser Micro Laryngeal Cup Forceps

Extremely Delicate

CODE	DESCRIPTION	CUPS	LENGTH
74-5960	Straight	1 mm	8⅝ in 220 mm
74-5964	Angled Left	1 mm	8⅝ in 220 mm
74-5962	Angled Right	1 mm	8⅝ in 220 mm
74-5963	Angled Up	1 mm	8⅝ in 220 mm

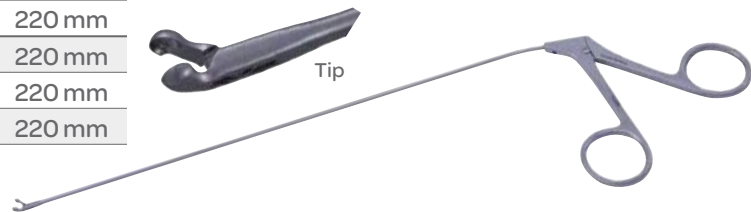

### Kleinsasser Micro Laryngeal Cup Forceps

CODE	DESCRIPTION	CUPS	LENGTH
74-6019	Straight	1 mm	10¾ in 270 mm
74-6020	Straight	2 mm	10¾ in 270 mm
74-6024	Curved Left	1 mm	10¾ in 270 mm



74-6024

## Forceps (Micro Laryngeal Grasping)

### Jako-Kleinsasser Micro Laryngeal Grasping Forceps

CODE	DESCRIPTION	LENGTH
74-5972	Straight	8⅝ in 220 mm
74-5971	Curved Right	8⅝ in 220 mm

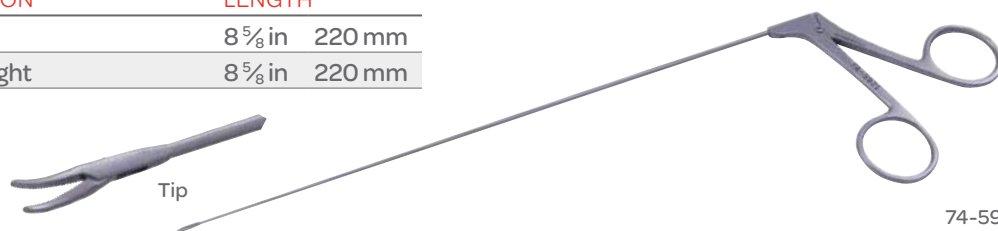

74-5971

## Forceps (Laryngeal)

### Jako Micro Laryngeal Instruments Alligator Grasping Forceps

Serrated Jaws

CODE	DESCRIPTION	JAWS	LENGTH
74-5920	Straight	1.5x10 mm	9½ in 240 mm
74-5921	Curved Left	1.5x8.5 mm	9½ in 240 mm
74-5922	Curved Right	1.5x8.5 mm	9½ in 240 mm
74-5923	Curved Up	1.5x8.5 mm	9½ in 240 mm

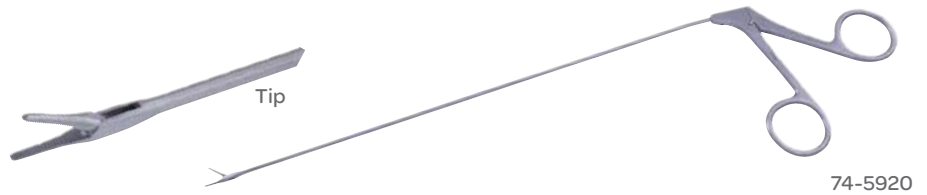

## Forceps (Middle Ear)

### House Miniature Forceps

3 mm, Finely Serrated

CODE	DESCRIPTION	LENGTH
61-0160	73 mm Shaft	5¼ in 135 mm



### Ebonized House-Wullstein Miniature Forceps

3 mm, Finely Serrated

CODE	DESCRIPTION	LENGTH
61-0160E	75 mm Shaft	5¼ in 135 mm



## Forceps (Middle Ear)

### House Oval Cup Forceps

CODE	DESCRIPTION	CUPS	LENGTH
61-0152	Straight, 75 mm Shaft	0.6 x 1.0 mm Oval	5 ¼ in 135 mm
61-0154	Angled Left, 75 mm Shaft	0.6 x 1.0 mm Oval	5 ¼ in 135 mm
61-0155	Angled Right, 75 mm Shaft	0.6 x 1.0 mm Oval	5 ¼ in 135 mm
61-0142	Angled Right 15°, 0.9 mm	Oval	5 ¼ in 135 mm
61-0143	Angled Left 15°, 0.9 mm	Oval	5 ¼ in 135 mm
61-0155E	Ebonized		5 ¼ in 135 mm



### House Miniature Forceps

4.0 mm, Finely Serrated

CODE	DESCRIPTION	LENGTH
61-0147	73 mm Shaft	5 ¼ in 135 mm
61-0147E	75 mm Shaft, Ebonized	5 ¼ in 135 mm



61-0147

### House Wullstein Miniature Ear Cup Forceps

Very Fine Oval Cup

CODE	DESCRIPTION	CUP SIZE	LENGTH
61-4122	Straight, 75 mm Shaft	0.6 x 1 mm	5 in 125 mm
61-0170	Angled Up, 72 mm Shaft	0.6 x 1 mm	5 in 125 mm
61-1290	Angled Down, 72 mm Shaft	0.6 x 1 mm	5 in 125 mm
61-1287	Angled Up 35°, 72 mm Shaft	0.6 x 1 mm	5 in 125 mm
61-1288	Angled Up 90°, 72 mm Shaft	0.6 x 1 mm	5 in 125 mm



61-0170

### House Alligator Crimper Forceps

Serrated

CODE	DESCRIPTION	JAWS	LENGTH
61-0138	75 mm Shaft	8 mm Tapered to Dull Point	8 ⅝ in 220 mm



## Forceps (Middle Ear)

### House Alligator Forceps

Serrated

CODE	DESCRIPTION	SHAFT	JAWS	LENGTH
61-0146	Straight	74 mm	6 mm	5 ½ in 140 mm
61-0140	Right Side Opening	75 mm	6 mm	5 ¼ in 135 mm



61-0146

### Hough CRURA Stapedectomy Forceps

3 mm Blade, Smooth 5 mm Jaws, Shaft 75 mm

CODE	DESCRIPTION	LENGTH
61-0130	Angled 45°, Left	9 ½ in 240 mm
61-0129	Angled 45°, Right	9 ½ in 240 mm
61-0126	Angled 45°, Right	9 ½ in 240 mm



61-0126

### House Strut Forceps

75 mm Shaft

CODE	JAWS	LENGTH
61-0139	Smooth 6 mm	5 ¼ in 135 mm



### McGee Wire Crimper Forceps

Delicate 3 mm

CODE	SHAFT	JAWS	LENGTH
61-0124	72 mm	Angled Down	5 ¼ in 135 mm
61-0125	75 mm	Straight	5 ¼ in 135 mm



61-0124



## Forceps (Nasal)

### Access Blakesley Forceps

CODE	DESCRIPTION	DIAMETER	WORKING LENGTH
11-102	0°	4 mm	89 mm
11-142	45°	4 mm	89 mm
11-192	90°	4 mm	89 mm

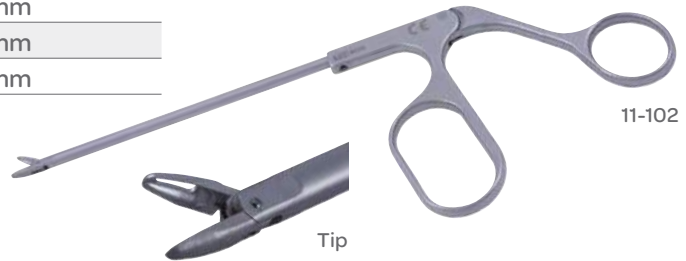

### Blakesley Nasal Forceps

CODE	DESCRIPTION	TIP SIZE
66-2551	Straight, Serrated	6 x 13 mm



### Noyes Nasal Dressing Forceps

Serrated Jaws, 110 mm Shaft

CODE	JAWS	LENGTH
66-2030	4 x 14 mm	6 <sup>3</sup> / <sub>4</sub> in 171 mm



### Takahashi Forceps

CODE	DESCRIPTION	JAWS	LENGTH
63-2026	Straight	2 x 10 mm	6 <sup>3</sup> / <sub>4</sub> in 171 mm

### Takahashi Nasal Forceps

4<sup>3</sup>/<sub>8</sub> in (110 mm) Shaft

CODE	DESCRIPTION	CUP SIZE	LENGTH
63-2019	Upturned 45°	2 x 8 mm	7 <sup>1</sup> / <sub>4</sub> in 185 mm
63-2020	Straight	2.5 x 8 mm	7 <sup>1</sup> / <sub>4</sub> in 185 mm
63-2020S	Straight with Suction	3 x 10 mm	7 <sup>1</sup> / <sub>4</sub> in 185 mm
63-2021	Straight	4 x 10 mm	7 <sup>1</sup> / <sub>4</sub> in 185 mm

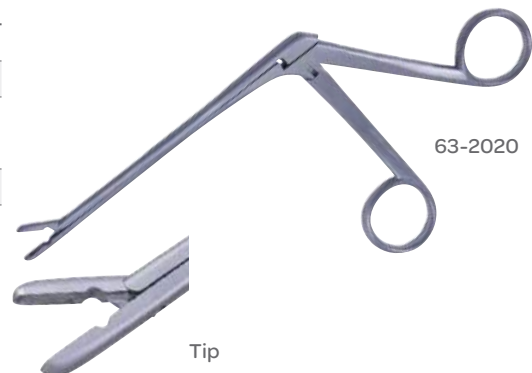

## Forceps (Nasal)

### Weil-Blakesley Nasal Forceps

Fenestrated Oval Cups, 4<sup>3</sup>/<sub>8</sub> in (110 mm) Shaft

CODE	SIZE	TIP	LENGTH
66-2810	#00	2.5 mm, Upturned 45°	7½ in 190 mm
66-2811	#0	3.5 mm, Upturned 45°	7½ in 190 mm
63-7634	#0	3.5 mm, Upturned 90°	7½ in 190 mm
66-2812	#1	4 mm, Upturned 45°	7½ in 190 mm
63-7635	#1	4 mm, Upturned 90°	7½ in 190 mm
66-2813	#2	5 mm, Upturned 45°	7½ in 190 mm

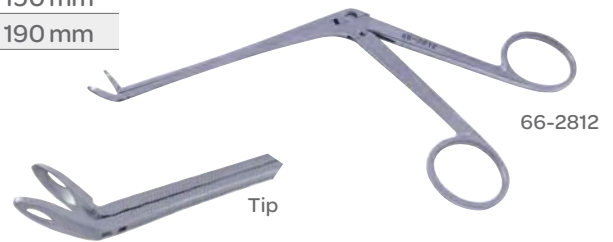

### Weil-Blakesley Nasal Forceps

Upturned 45°, Fenestrated Oval Cups, 4<sup>3</sup>/<sub>8</sub> in (110 mm) Shaft, w/Suction

CODE	SIZE	TIP	LENGTH
66-2810S	#00	2.5 mm	7½ in 190 mm
66-2811S	#0	3.5 mm	7½ in 190 mm
66-2812S	#1	4 mm	7½ in 190 mm
66-2813S	#2	5 mm	7½ in 190 mm



### Weil-Blakesley Nasal Forceps

Straight, Fenestrated Oval Cups, 4<sup>3</sup>/<sub>8</sub> in (110 mm) Shaft

CODE	DESCRIPTION	SIZE	TIP	LENGTH
63-2012		#00	2.5 mm	7½ in 190 mm
63-2009		#0	3.5 mm	7½ in 190 mm
63-2010		#1	4 mm	7½ in 190 mm
63-2011		#2	5 mm	7½ in 190 mm
63-2012S	With Suction	#00	2.5 mm	7½ in 190 mm
63-2009S	With Suction	#0	3.5 mm	7½ in 190 mm
63-2010S	With Suction	#1	4 mm	7½ in 190 mm
63-2011S	With Suction	#2	5 mm	7½ in 190 mm



## Forceps (Nasal)

### Weil-Blakesley Nasal Forceps

Fenestrated Oval Cups, 2.5 mm x 4.5 mm cups, 4  $\frac{3}{8}$  in (11 mm) shaft

CODE	DESCRIPTION	LENGTH
63-7423S	#00 Straight with Suction	7 $\frac{1}{2}$ in 190 mm
63-7424S	#00 Upturned 45° with Suction	7 $\frac{1}{2}$ in 190 mm
63-7425S	#00 Upturned 90° with Suction	7 $\frac{1}{2}$ in 190 mm
63-7423	#00 Straight	7 $\frac{1}{2}$ in 190 mm
63-7424	#00 Upturned 45°	7 $\frac{1}{2}$ in 190 mm
63-7424S	#00 Upturned 90°	7 $\frac{1}{2}$ in 190 mm



### Weil-Blakesley Thru-Cutting Nasal Forceps

Bottom Jaw Serrated

CODE	DESCRIPTION	JAWS	SHAFT	LENGTH
63-6600	#00 Straight	2.5 mm	120 mm	7 $\frac{1}{4}$ in 185 mm
63-6602	#00 Upturned 45°	2.5 mm	120 mm	7 $\frac{1}{4}$ in 185 mm
63-6610	#0 Straight	3.5 mm	120 mm	7 $\frac{1}{4}$ in 185 mm
63-6618	#0 Jaws Angled Left	3.5 mm	120 mm	7 $\frac{1}{4}$ in 185 mm
63-6612	#0 Upturned 45°	3.5 mm	120 mm	7 $\frac{1}{4}$ in 185 mm
63-6611	#1 Straight	4 mm	120 mm	7 $\frac{1}{4}$ in 185 mm
63-6613	#1 Upturned 45°	4 mm	120 mm	7 $\frac{1}{4}$ in 185 mm

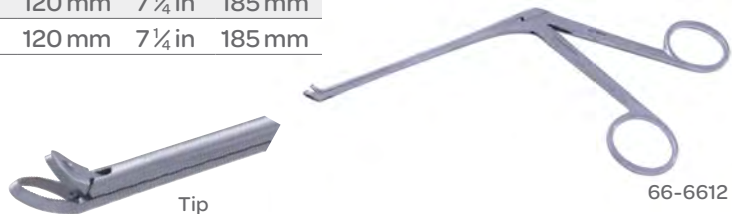

## Forceps (Nasal Dressing)

### Hartmann Nasal Dressing Forceps

CODE	DESCRIPTION	LENGTH
63-2017	Nasal Dressing Forceps	7 in 175 mm



## Foreceps (Nasal Polyp)

### Watson Williams Nasal Polyp Forceps

CODE	JAWS	SHAFT	LENGTH
63-2002	6 x 8 mm	110 mm	7 1/8 in 180 mm
63-2003	9 x 13 mm	110 mm	7 1/8 in 180 mm



## Foreceps (Nasal Punch)

### Gruenwald Nasal Punch Forceps

Jaws with No Cutting Edge

CODE	JAWS	SHAFT	LENGTH
66-3121	2.5 x 9 mm	110 mm	7 1/2 in 190 mm



## Forceps (Oval Cup)

### Ultra™ Oval Cup Forceps

Very Fine 4.0 mm Jaws with Oval Spoon Jaws, 0.9 x 0.2 mm

CODE	DESCRIPTION	LENGTH
61-0150	75 mm Shaft	5 1/4 in 135 mm
61-0150E	Ebonized	5 1/4 in 135 mm

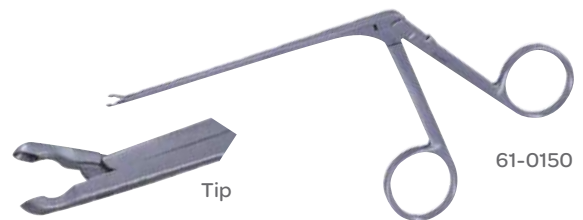

## Forceps (Post Nasal)

### Hildyard Post Nasal Forceps

CODE	DESCRIPTION	LENGTH
66-2519	Round Cup, 3.5 mm	6 3/4 in 170 mm

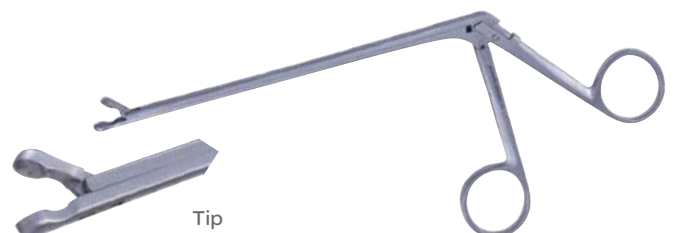

## Forceps (Septum)

### Asch Septum Straightening Forceps

CODE	DESCRIPTION	JAWS	LENGTH
67-6520	Angled on Flat	7 x 49 mm	8 <sup>3</sup> / <sub>4</sub> in 220 mm



### Bruening Septum Forceps

CODE	DESCRIPTION	LENGTH
66-2502	9 x 11 mm	7 <sup>1</sup> / <sub>8</sub> in 180 mm

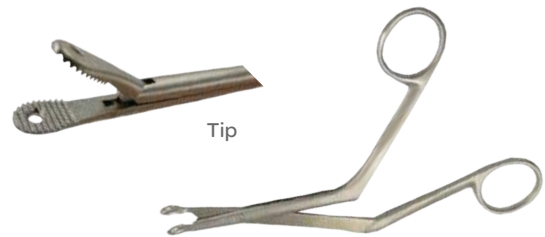

### Jansen-Middleton Septum Forceps

Cutting Jaws

CODE	DESCRIPTION	LENGTH
66-2560	4 x 11 mm	6 <sup>3</sup> / <sub>4</sub> in 170 mm

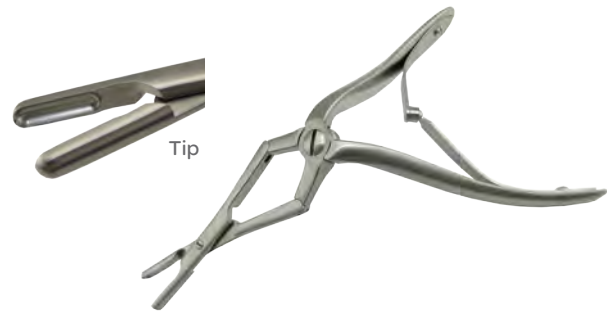

### Jansen-Middleton Septum Forceps

Thru-Cutting Jaws

CODE	DESCRIPTION	SHAFT	LENGTH
66-2565	4 x 14 mm		7 <sup>1</sup> / <sub>2</sub> in 190 mm
66-2566	3 x 13 mm	Narrow	7 <sup>1</sup> / <sub>2</sub> in 190 mm



66-2565

### Walsham Septum Straightening Forceps

CODE	DESCRIPTION	LENGTH
67-6513	Bayonet Blades, Straight Jaws	9 in 230 mm



## Forceps (Septum)

### Septum Morselizing Forceps

CODE	DESCRIPTION	LENGTH
63-5007	Straight	7¾ in 195 mm
63-5009	Angled	7¾ in 195 mm

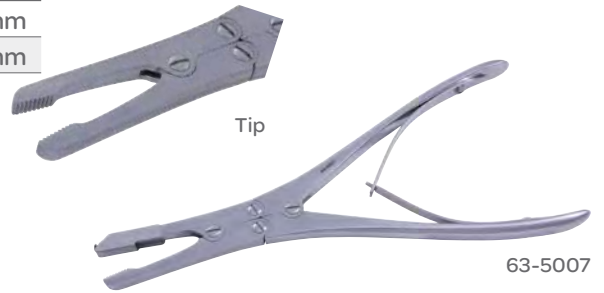

## Forceps (Sinus)

### Sinus Giraffe Forceps

Double-Action Cupped Forceps

CODE	DESCRIPTION	JAWS	LENGTH
63-5730	70° Horizontal	3 mm	4¾ in 120 mm
63-5731	110° Horizontal	3 mm	4¾ in 120 mm
63-5736	70° Vertical	3 mm	4¾ in 120 mm
63-5734	110° Vertical	3 mm	4¾ in 120 mm
63-5732	70° Horizontal	4 mm	4¾ in 120 mm
63-5733	110° Horizontal	4 mm	4¾ in 120 mm
63-5737	70° Vertical	4 mm	4¾ in 120 mm
63-5735	110° Vertical	4 mm	4¾ in 120 mm



## Forceps (Sinus & Nasal)

### Circular Cutting Antrum Punch Forceps

Allows Cutting 360° without Rotating the Instrument

CODE	DESCRIPTION	BITE	SHAFT
63-7453	Straight	3.5 mm	170 mm
63-7455	45° Upturned	3.5 mm	170 mm



## Forceps (Sinus & Nasal)

### Heuwer Antrum Forceps

Fenestrated and Stationary to 90°, Moveable to 120° Jaws, 100 mm Shaft

CODE	JAWS	LENGTH
63-7460	3 x 8 mm	4 in 100 mm



## Forceps (Sponge)

### Ferris Smith Sponge Forceps

Serrated Jaw

CODE	JAWS	LENGTH
66-2540	6 x 8 mm	7½ in 190 mm



## Forceps (Tonsil)

### Allis-Coakley Tonsil Forceps

One Open Ring Handle

CODE	DESCRIPTION	LENGTH
72-1002	Straight	7½ in 190 mm
72-1003	Slight Curve	7½ in 190 mm
72-1004	Strong Curve	7½ in 190 mm

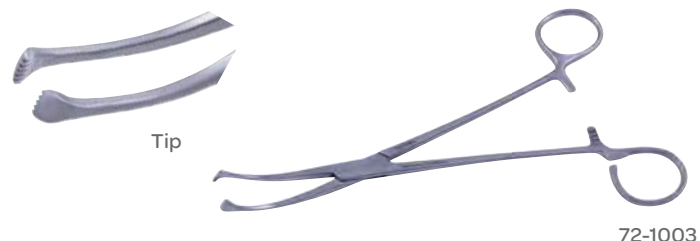

## Forceps (Tonsil)

### Colver Tonsil Seizing Forceps

CODE	DESCRIPTION	LENGTH
72-4019	Curved	7½ in 190 mm



### St. Clair Adenoid Forceps

CODE	DESCRIPTION	LENGTH
71-5018	5 x 10 mm, Ring Jaw	7¼ in 185 mm



### Tivnen Tonsil Forceps

One Open-Ring Handle

CODE	DESCRIPTION	LENGTH
72-1007	3 x 3 Prongs, Angled	8 in 200 mm



### White Tonsil Forceps

One Open Ring Handle

CODE	DESCRIPTION	LENGTH
72-1005	Medium Curve	9½ in 241 mm



## Forceps (Turbinate)

### Stryucken Turbinate Forceps

With Sharp Thru-Cutting Edge, 110 mm Shaft

CODE	JAWS	LENGTH
66-3110	1 x 15 mm	6¾ in 171 mm





## Handles (Knife)

### Landolt Knife Handle

CODE	DESCRIPTION	LENGTH
01-2721		8¼ in 210 mm
01-2725		10 in 250 mm
01-2726	Replacement Collet	



## Hooks (Double)

### Cottle Double Hook

Sharp Prongs

CODE	DESCRIPTION	LENGTH
67-2003	3 mm Wide	6 in 150 mm

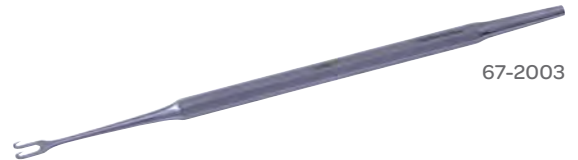

### Cottle-Joseph Double Hook

Sharp Prongs

CODE	DESCRIPTION	LENGTH
63-0313	2 mm Wide	5½ in 140 mm



### Freer Double Hook

CODE	DESCRIPTION	PRONGS	LENGTH
20-5202	3 mm Wide	Sharp	6 in 150 mm

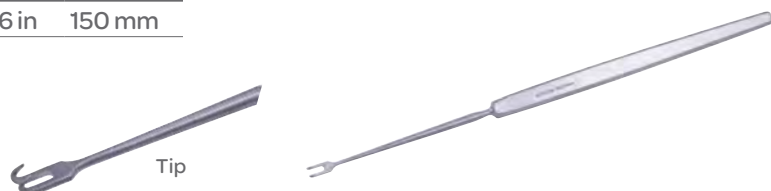

## Hooks (Dura)

### Adson Dura & Nerve Hook

CODE	DESCRIPTION	PRONGS	LENGTH
20-2722	3 mm Tip	Sharp	8 in 200 mm
20-2723	3 mm Tip	Blunt	8 in 200 mm



## Hooks (Ear)

### Day Ear Hook

CODE	DESCRIPTION	TIP	LENGTH
62-1650	Extra Small	1.5 mm	6 in 150 mm
62-1651	Small	2 mm	6 in 150 mm
62-1652	Large	2.5 mm	6 in 150 mm

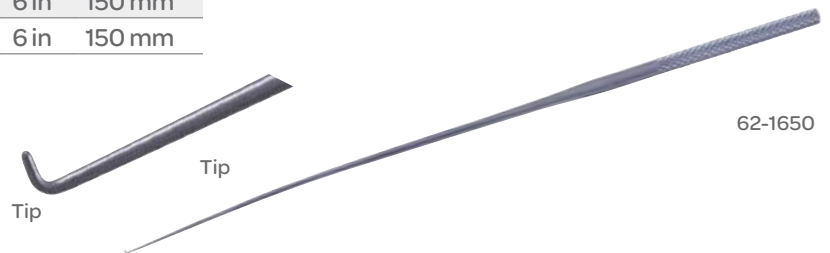

### Lillie Ear Hook

Angled 90°

CODE	TIP	LENGTH
61-0024	1 mm Ball	7 in 175 mm



## Hooks (Double Fixation)

### Double Fixation Hook

CODE	DESCRIPTION	LENGTH
60-1298	1.5 mm Wide	5¼ in 135 mm
60-1299	2 mm Wide	5¼ in 135 mm

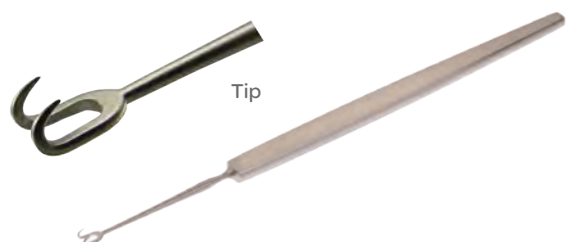

## Hooks (Iris, Middle Ear)

### Tyrell Iris Hook

CODE	DESCRIPTION
38-6525	Iris Hook



### Shea Oblique Hook

CODE	DESCRIPTION	HOOK	LENGTH
62-0425	Angled 90°	Blunt 0.2mm	6 in 150 mm

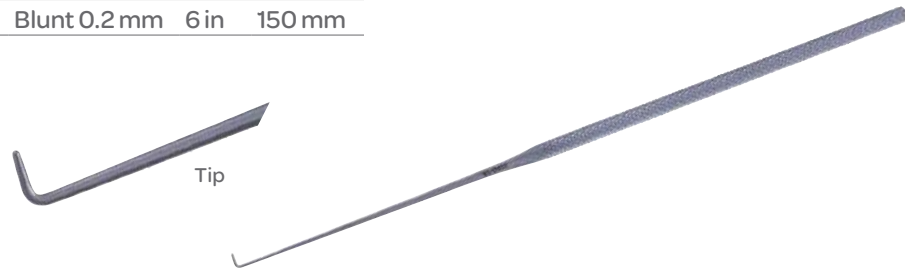

### Schuknecht Posterior Foot Plate Hook

CODE	DESCRIPTION	TIP	LENGTH
61-0475	Angled Down Shaft	0.6 mm	6½ in 165 mm



### Schuknecht Anterior Foot Plate Hook

CODE	DESCRIPTION	TIP	LENGTH
61-0473	Angled Up Shaft	0.3 mm	6½ in 165 mm



## Hooks (Middle Ear)

### Shea Foot Plate Hook

Very Fine 4.0 mm Jaws with 0.9 x 0.2 mm Oval Spoon

CODE	DESCRIPTION	TIP SIZE	LENGTH
62-0420	Angled 45°	1 mm	5¼ in 135 mm
62-0440	Angled 90°	1 mm	5¼ in 135 mm



### Saunders-Paparella Stapes Hook

Malleable Shaft, Fine Point

CODE	DESCRIPTION	TIP SIZE	LENGTH
61-3770	Angled Shaft, 90° Angled Tip	0.33 mm	6½ in 165 mm

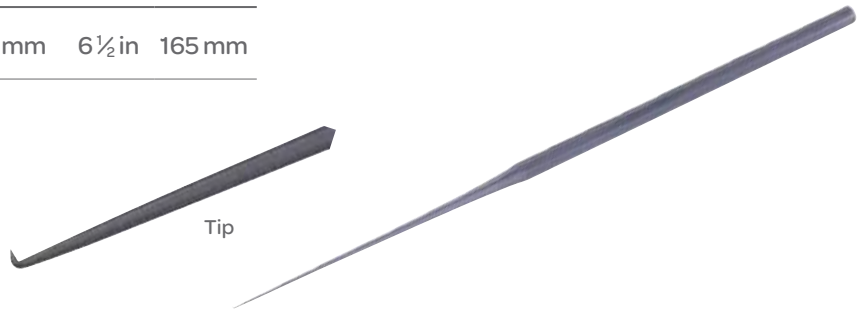

### Schuknecht Stapes Hook

Angled Shaft

CODE	DESCRIPTION	TIP	LENGTH
61-0476	Angled 90° Up	1 mm	6¼ in 160 mm



### Ebonized Schuknecht Hook

CODE	DESCRIPTION	TIP	LENGTH
61-0474E	Shaft Angled Down	0.3 mm	6¾ in 170 mm



## Hooks (Middle Ear, Nerve, Single)

### House Hook

CODE	DESCRIPTION
61-0386	Angled Right 90°



### Single Hook

CODE	DESCRIPTION	LENGTH
20-5012	2 mm Sharp	5 3/4 in 146 mm



## Hooks (Nerves)

### Cushing Nerve Hook

CODE	DESCRIPTION	LENGTH
20-2231	4 mm Ball Tip	7 1/2 in 190 mm
20-2232	6 mm Ball Tip	7 1/2 in 190 mm



20-2231

## Hooks (Retractor)

### Tracheal Hook

CODE	PRONG	LENGTH
20-6403	3 Sharp Prongs	6 1/4 in 160 mm



### Cottle Single Hook

CODE	DESCRIPTION	DETAILS	LENGTH
63-0302	Small	Shallow Curved	5 1/4 in 135 mm
63-0303	Small	Deep Curve	5 1/4 in 135 mm
63-0304	Large	Deep Curve	5 1/4 in 135 mm

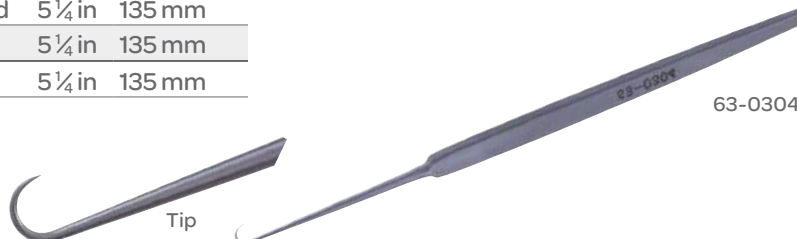

63-0304

## Hooks (Skin)

### Barsky Skin Hook

CODE	DESCRIPTION	LENGTH
20-3501	Single Prong	6 in 150 mm

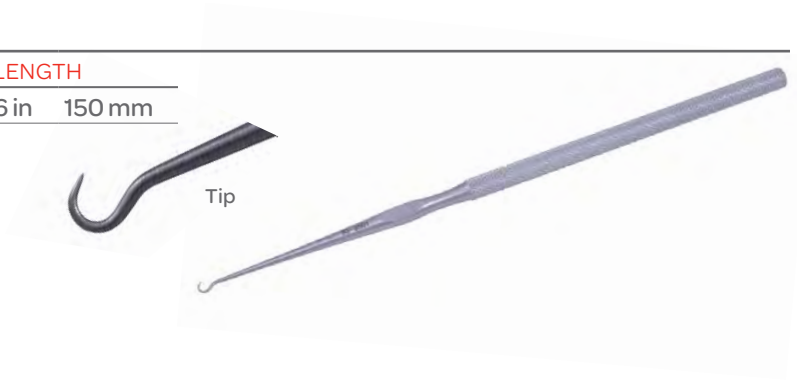

### Converse Skin Hook

CODE	DESCRIPTION	LENGTH
63-0306	Small	7 in 175 mm
63-0307	Large, Deep Curve	7 in 175 mm

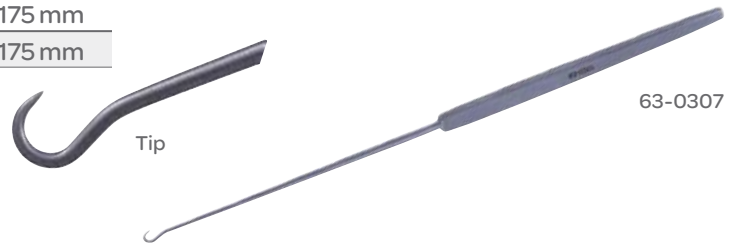

### Humby Swivel Skin Hook

CODE	DESCRIPTION	TIP	LENGTH
20-3532	Sharp	0.5 mm	4 ½ in 115 mm



### Joseph Skin Hook

CODE	DESCRIPTION	HOOK WIDTH	LENGTH
20-5001	Single Prong	4 mm	6 ¼ in 160 mm
20-5005	Double Prong	5 mm	6 ¼ in 160 mm
20-5007	Double Prong	7 mm	6 ¼ in 160 mm
20-5010	Double Prong	10 mm	6 ¼ in 160 mm



### Kilner Skin Hook

CODE	DESCRIPTION	LENGTH
20-5109	Sharp	6 in 150 mm



## Hooks (Tenaculum)

### Cottle Tenaculum Hook

CODE	DESCRIPTION	LENGTH
20-4016	Angled	6¼ in 160 mm



## Hooks (Thimble)

### Millard Thimble Hook

CODE	DESCRIPTION	LENGTH
67-2023	Single Prong	3¼ in 82 mm



## Hooks (Tracheal)

### News Tracheal Hook

CODE	DESCRIPTION	LENGTH
20-4015	Single Prong	6 in 150 mm



### Tracheal Hook

CODE	DESCRIPTION	LENGTH
20-6402	Double-Sharp Prongs	6¼ in 160 mm



## Hooks (Tracheal)

### Tracheal Hook

CODE	DESCRIPTION	LENGTH
20-6502	2 Blunt Prongs	6 ¼ in 160 mm



## Inserters (Middle Ear)

### Shea Prosthesis Placement Instrument

CODE	DESCRIPTION	TIP SIZE	LENGTH
62-0470	Angled 45°	0.5 mm	6 ¼ in 160 mm



## Instrument Covers (Forceps Protectors)

### Forceps Protectors

CODE	DESCRIPTION
62-4990	10 mm Wide, Protection Tube for Ear Forceps, Autoclavable

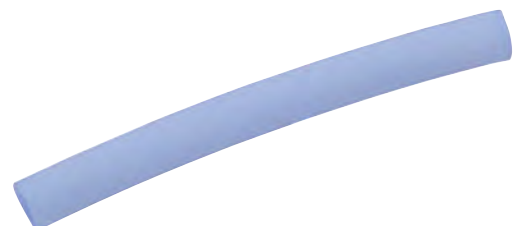



## Knives (Button End)

### Converse Button End Knife

CODE	LENGTH
67-1035	6 in 150 mm



### Joseph Button End Knife

CODE	DESCRIPTION	LENGTH
67-1030	Straight	6 in 150 mm
67-1060	Angled	6 in 150 mm



## Knives (Canal)

### Jordon Canal Knife

Tapered, 2 x 3 mm Blade

CODE	DESCRIPTION	LENGTH
61-0415	Angled 45°	6 ½ in 165 mm

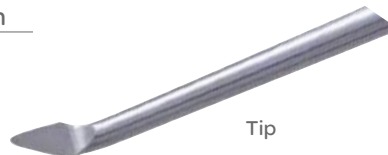

## Knives (Cartilage)

### Maltz Cartilage Knife

Blunt Tip, Angled

CODE	DESCRIPTION	LENGTH
67-1065	With Blade Guard	6 3/4 in 170 mm



## Knives (Ear)

### Ear Knife Blade & Handle

CODE	DESCRIPTION
61-0258	Replacement Baldes (6 per package)
61-0256	Chuck Handle

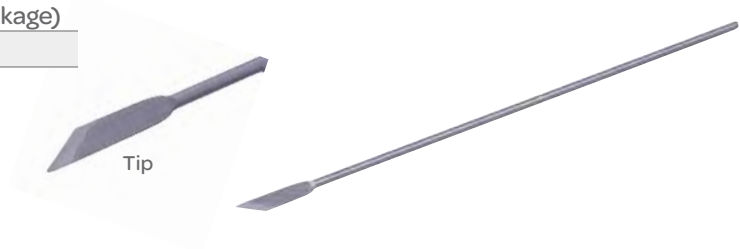

## Knives (Micro-Laryngeal)

### Jako Micro Laryngeal Knife

CODE	DESCRIPTION	LENGTH
74-4510	Sickle Blade	11 5/8 in 295 mm

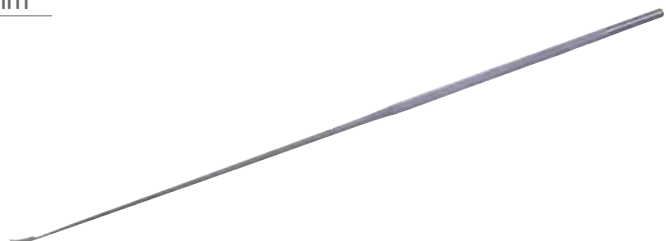

## Knives (Middle Ear)

### McCabe Canal Knife

CODE	TIP	BLADE DIAMETER	LENGTH
62-0481	Sharp	2 mm	6 <sup>3</sup> / <sub>4</sub> in 170 mm



### Rosen Cartilage Knife

CODE	DESCRIPTION	LENGTH
67-1080	Double-Ended Blades at 45° and 90°	7 <sup>3</sup> / <sub>4</sub> in 195 mm



### Guilford-Wright Elevator Knife

CODE	TIP WIDTH	LENGTH
61-0331	2 mm	5 <sup>1</sup> / <sub>2</sub> in 140 mm

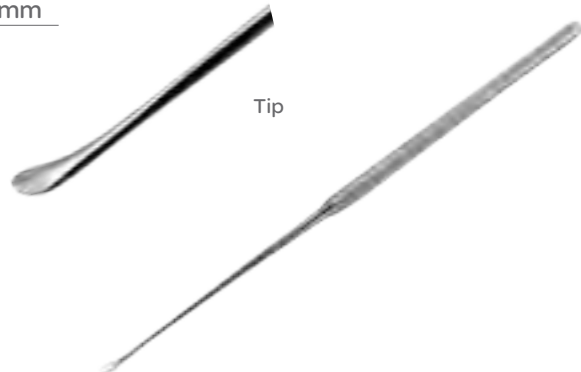

### Tabb Flap Knife

Double-Ended

CODE	BLADES	LENGTH
61-0270	Angled 25° and 45°	6 <sup>1</sup> / <sub>4</sub> in 160 mm
61-0271	Angled 90° and 120°	6 <sup>1</sup> / <sub>2</sub> in 165 mm



## Knives (Middle Ear)

### House Incudostapedial Joint Knife

CODE	ANGLE	BLADE	LENGTH
61-0396	20°	0.5 x 1.5 mm	6½ in 165 mm
61-0378	60°	0.75 mm	6¾ in 170 mm

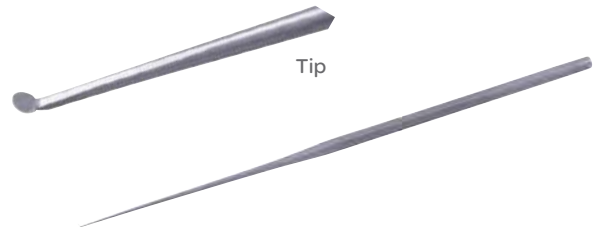

### Paparella Incudostapedial Joint Knife

CODE	ANGLE	BLADE	LENGTH
61-0435	20°	0.5 x 1.5 mm	6½ in 165 mm

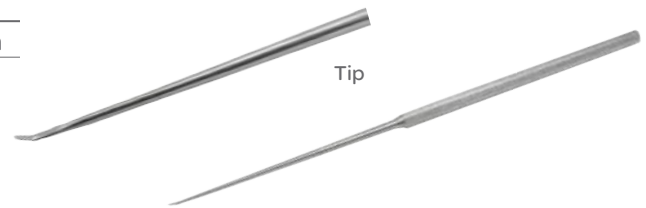

### House Lancet Knife

#2 Knife

CODE	ANGLE	BLADE	LENGTH
61-0377	45°	2 x 3 mm	6½ in 165 mm



### Hough Drum Scraper

Shaft Angled 15°

CODE	POINT/TIP	LENGTH
61-0352	0.5 mm Point Angled 45° on 2.5 mm Tip Angled 60°	6 in 150 mm



### Tabb Myringoplasty Knife

Curved

CODE	BLADE	LENGTH
61-0269	Curved, 8 mm	6½ in 165 mm



## Knives (Middle Ear)

### House Myringotomy Knife

CODE	BLADE	LENGTH
61-0397	3.5 mm	6½ in 165 mm



### Tabb Pick Knife

CODE	BLADE	LENGTH
61-0273	3 mm	6¼ in 160 mm



### Schuknecht Roller Knife

CODE	BLADE	SHAFT	LENGTH
61-0470	3 mm	Curved	7½ in 190 mm
61-0471	3 mm	90°	7½ in 190 mm



### House Tympanoplasty Knife

CODE	DESCRIPTION	BLADE	LENGTH
61-0395	Curved	7 mm	6½ in 165 mm



## Knives (Middle Ear, Myringotomy, Nasal)

### Hough "Whirly Bird" Knife

Strong Curve, 1 x 5 mm Blade

CODE	DESCRIPTION	LENGTH
61-0344	#1 Angled Right	6 in 150 mm
61-0345	#2 Angled Left	6 in 150 mm



### Myringotomy Knife

CODE	DESCRIPTION	LENGTH
61-0266	Straight	5¼ in 135 mm



## Knives (Middle Ear, Myringotomy, Nasal)

### Cottle Nasal Knife

CODE	DESCRIPTION	BLADE	LENGTH
67-1020	Straight	4 mm	5 ¼ in 135 mm
67-1033	Straight	Round	6 in 150 mm

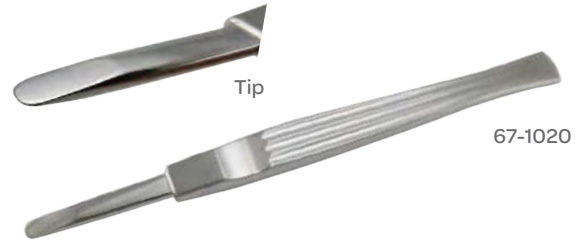

### Joseph Nasal Knife

Double Edge Blade

CODE	DESCRIPTION	BLADE	LENGTH
63-0813	Straight	4 x 18 mm	6 in 150 mm
63-0812	Curved	4 x 22 mm	6 in 150 mm
63-0814	Curved	4 x 22 mm	6 in 150 mm



## Knives (Middle Ear)

### Sickle Knife

Middle Ear

CODE	TIP	ANGLE	LENGTH
61-0594	Sharp 10 mm	30° Left	7 ½ in 190 mm
61-0595	Sharp 10 mm	30° Right	7 ½ in 190 mm



### House Sickle Knife

CODE	DESCRIPTION	BLADE	LENGTH
61-0379	"Number One Knife"	0.75 mm, Curved	6 ½ in 165 mm

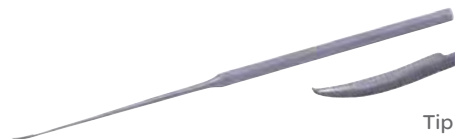

### Paparella Sickle Knife

CODE	DESCRIPTION	BLADE	LENGTH
61-3789	Straight	5.5 mm	6 ½ in 165 mm



### Schuknecht Sickle Knife

CODE	DESCRIPTION	SHAFT	LENGTH
61-0469	7 mm	Angled	6 ¼ in 160 mm



## Knives (Septum)

### Freer Septum Knife

CODE	DESCRIPTION	TIP SIZE	LENGTH
66-5210	"D" Model	5 x 8 mm	6 ¼ in 160 mm
66-5208	Angled	3 mm Angled	7 in 175 mm
66-5201	"E" Model	-	7 ¼ in 185 mm



66-5208

## Knives (Sinus & Nasal)

### Sickle Knife

Curved Blade

CODE	TIP	LENGTH
63-7580	10 mm Sharp	7 ½ in 190 mm
63-7582	10 mm Blunt	7 ½ in 190 mm

Tip  
63-7580

### Ballenger Swivel Knife

CODE	DESCRIPTION	BLADE	LENGTH
66-5003	Straight	3 mm	7 ½ in 190 mm
66-5004	Straight	3 mm	7 ½ in 190 mm
66-5005	Straight	3 mm	7 ½ in 190 mm
66-5013	Bayonet	3 mm	8 in 200 mm
66-5014	Bayonet	4 mm	8 in 200 mm
66-5015	Bayonet	5 mm	8 in 200 mm



66-5015

## Knives (Tonsil)

### Canfield Tonsil Knife

CODE	BLADE	LENGTH
72-2030	9 mm Curved	8 ¼ in 210 mm



## Knives (Tonsil)

### Fisher Tonsil Knife

CODE	DESCRIPTION	LENGTH
72-2540	Slightly Curved Blade	7½ in 190 mm



## Laryngoscope Holders

### Lewy Laryngoscope Holder

CODE	DESCRIPTION
74-3520	Laryngoscope Holder



## Loops (Ear)

### Billeau Ear Loop

CODE	SIZE	LENGTH
62-1401	Small	6½ in 165 mm
62-1402	Medium	6½ in 165 mm
62-1403	Large	6½ in 165 mm



## Mallets (Sinus & Nasal)

### Cottle Mallet

One Flat Face and One Round Face

CODE	DESCRIPTION	LENGTH
67-4020	10 oz, 1¼ in (31 mm) Diameter Head	7½ in 190 mm





## Mirrors (Laryngeal)

### Laryngeal Mirror

Stationary Octagonal Handle

CODE	DESCRIPTION	SIZE	LENGTH
73-4808	#000	8 mm	6 <sup>3</sup> / <sub>4</sub> in 171 mm
73-4810	#00	10 mm	6 <sup>3</sup> / <sub>4</sub> in 171 mm
73-4812	#0	11 mm	6 <sup>3</sup> / <sub>4</sub> in 171 mm
73-4814	#1	14 mm	6 <sup>3</sup> / <sub>4</sub> in 171 mm
73-4816	#2	16 mm	6 <sup>3</sup> / <sub>4</sub> in 171 mm
73-4818	#3	18 mm	6 <sup>3</sup> / <sub>4</sub> in 171 mm
73-4820	#4	20 mm	6 <sup>3</sup> / <sub>4</sub> in 171 mm
73-4822	#5	22 mm	6 <sup>3</sup> / <sub>4</sub> in 171 mm
73-4824	#6	24 mm	6 <sup>3</sup> / <sub>4</sub> in 171 mm
73-4826	#7	26 mm	6 <sup>3</sup> / <sub>4</sub> in 171 mm
73-4828	#8	28 mm	6 <sup>3</sup> / <sub>4</sub> in 171 mm

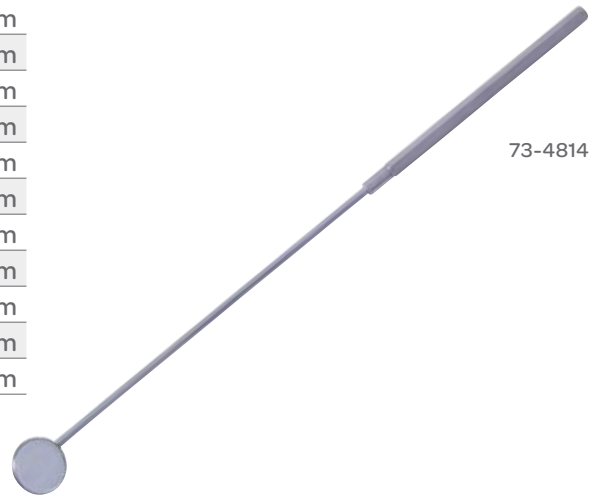

## Mirrors (Middle Ear)

### House Middle Ear Mirror

Straight Shaft

CODE	ANGLE	MIRROR	LENGTH
61-0390	45°	2 mm	6 <sup>1</sup> / <sub>2</sub> in 165 mm



## Mobilizers (Middle Ear)

### Derlacki Mobilizer

CODE	TIP	LENGTH
61-0516	Angled, Serrated Round End	6 <sup>1</sup> / <sub>4</sub> in 158 mm



### Hough-Derlacki Mobilizer

CODE	TIP	LENGTH
61-0343	Curved, 4 Pronged, 2 mm Diameter	6 <sup>1</sup> / <sub>4</sub> in 160 mm



## Mouth Gags (Tonsil & Laryngeal)

### Crowe-Davis Mouth Gag Blades

CODE	DESCRIPTION	SIZE
45-5111	#1	18 x 23 mm
45-5112	#2	20 x 62 mm
45-5113	#3	25 x 75 mm
45-5114	#4	25 x 95 mm
45-5115	#5	25 x 106 mm



45-5111

### Crowe-Davis Mouth Gag

CODE	DESCRIPTION	BITE
45-5122	Frame Only, Left	Double
45-5121	Frame Only, Right	Double
45-5122 x	Set of 2	Silicon Replacement Pads for Mouth Gag Frames 45-5122 and 45-5121
45-5126	Child Right	



45-5122

### Mclvor Mouth Gag & Mclvor Tongue Blade

CODE	DESCRIPTION	SIZE
45-5300	Complete Set, Includes 1 of each of the items listed below.	
45-5320	Mouth Gag	Frame Only
45-5311	Tongue Blade #1	22 X 69 mm
45-5312	Tongue Blade #2	24 X 90 mm
45-5313	Tongue Blade #3	25 X 100 mm



45-5320



45-5313

### Ring Blade

CODE	DESCRIPTION	SIZE
45-2140	Left #2	2 ¼ x 7/8 in 60 x 22 mm
45-2141	Left #3	3 x 1 1/8 in 76 x 28 mm
45-2143	Left #5	3 3/4 x 1 1/2 in 95 x 36 mm
45-2142	Left #4	3 1/2 x 1 1/4 in 90 x 32 mm
45-2144	Right #2	2 ¼ x 7/8 in 60 x 22 mm
45-2145	Right #3	3 x 1 1/8 in 76 x 28 mm
45-2146	Right #4	3 1/2 x 1 1/4 in 95 x 36 mm
45-2147	Right #5	3 3/4 x 1 1/2 in 90 x 32 mm



45-2140

## Mouth Gags (Tonsil & Laryngeal)

### Russel-Davis Tongue Blade

CODE	BLADE SIZE
45-5331	33 x 75 mm
45-5332	38 x 85 mm
45-5333	40 x 92 mm



45-5331

### Dingman Mouth Gag

CODE	DESCRIPTION
72-0800	Complete Set includes Frame, 2 Lateral Cheek Retractors and the 3 Grooved Blades listed below.
72-0801	Frame Only
72-0811	Small, Blades with Groove 25 x 55 mm
72-0812	Medium, Blades with Groove 27 x 60 mm
72-0813	Large, Blades with Groove 30 x 70 mm

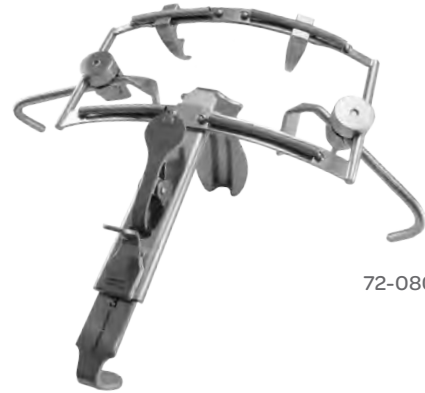

72-0800

### Jennings Mouth Gag

Standard Pattern

CODE	DESCRIPTION	LENGTH
72-0709	Extra Small	3 <sup>3</sup> / <sub>8</sub> in 90 mm
72-0711	Small	4 <sup>3</sup> / <sub>8</sub> in 112 mm
72-0713	Medium	5 <sup>1</sup> / <sub>8</sub> in 130 mm
72-0715	Large	6 in 150 mm

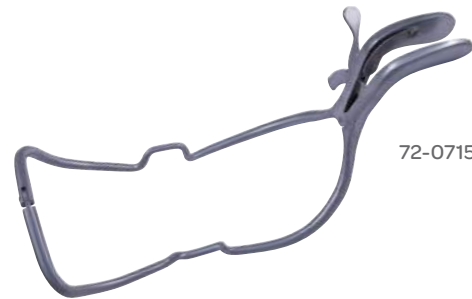

72-0715

## Mouth Gags (Tonsil & Laryngeal)

### Sluder Jansen/Schink Mouth Gag

CODE	DESCRIPTION	LENGTH
72-0515	Adult	4 <sup>1</sup> / <sub>4</sub> in 108 mm



## Mouth Gags (Tonsil & Laryngeal)

### Denhardt Mouth Gag

Self-Retaining

CODE	DESCRIPTION
72-0560	Serrated, No inserts needed (Silicon pads not used with this item)
72-0561	Frame for use with Silicon Pads 72-0560x
72-0560x	Silicon Inserts for use with 72-0561



72-0560

### McKesson Mouth Prop

Sold in pairs, Black

CODE	DESCRIPTION
62-1211	Infant
68-1212	Child
68-1214	Adult



68-1214

## Needles (Middle Ear)

### Shambaugh-Derlacki Needle

CODE	DESCRIPTION	LENGTH
61-0408	Straight Tip with Angled Shaft, Fine	6 ¼ in 160 mm
61-0409	Straight Tip with Angled Shaft, Super Fine	6 ¼ in 160 mm



61-0408

### McGee Perforating Needle

CODE	DESCRIPTION	LENGTH
61-0431	Straight Point on Angled Shaft	6 ½ in 165 mm



## Needles (Middle Ear)

### House-Rosen Type Needle

Curved

CODE	DESCRIPTION	TIP SIZE	LENGTH
61-0361	Justify left	3 mm	6½ in 165 mm
61-0366	Slightly Dulled Point	4 mm	6½ in 165 mm



### Schuknecht Stapes Needle

CODE	DESCRIPTION	LENGTH
61-0477	Angled Shaft, Straight Tip	6¼ in 160 mm



### Austin Needle

CODE	DESCRIPTION	TIP SIZE	LENGTH
61-0305	Slightly Curved	10 mm	6¼ in 160 mm

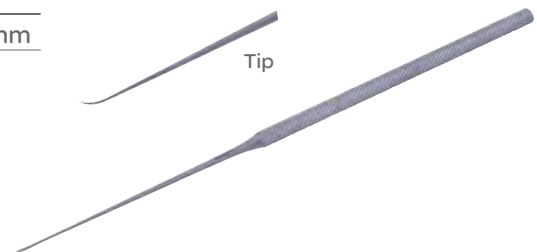

### House Needle

CODE	DESCRIPTION	TIP SIZE	LENGTH
61-0359	Curved, Sharp Point	4 mm	6½ in 165 mm

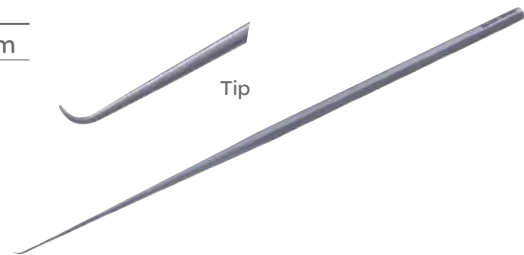

### Saunders-Paparella Needle

Straight, Malleable Shaft, Fine Point

CODE	DESCRIPTION	LENGTH
61-3750	#5, Fine	6½ in 165 mm
61-3752	#6, Heavy	6½ in 165 mm



## Needles (Septum)

### Septum Needle

CODE	DESCRIPTION
63-7591	90° Tip, Straight Shaft, 22 Gauge



## Needles (Tonsil)

### Tonsil Needle

23 Gauge

CODE	DESCRIPTION	NEEDLE EXTENSION
72-9514	45° Angle	13 mm
72-9510	Straight	13 mm



## Nippers (Middle Ear)

### House-Dieters Malleus Nipper

75 mm Shaft

CODE	DESCRIPTION	LENGTH
61-0158	1.5 mm Jaws	5 in 125 mm
61-0157	2 mm Jaws	5 in 125 mm



## Nippers (Malleus)

### Malleus Nipper

Delicate, Non-Serrated

CODE	DESCRIPTION	LENGTH
61-0700	7 mm Jaws	4 1/2 in 115 mm



## Sponges

### Secto® Tonsil Sponges

Sterile Pack, 5 Per Card/Pouch, 25 Pouches Per Dispenser, 2 Dispensers Per Case

CODE	DESCRIPTION	SIZE
81-1010	X-Ray Detectable	$\frac{5}{8}$ in 16 mm
81-1011	X-Ray Detectable	1 in 25 mm
81-1012	X-Ray Detectable	4 $\frac{1}{2}$ in 32 mm

Note: Cord Length on all sizes is 10 in (254 mm)



81-1010

## Osteotomes

### Anderson-Neivert Osteotome

CODE	DESCRIPTION	WIDTH	LENGTH
63-0120	Curved Left	4 mm	8 $\frac{1}{4}$ in 210 mm
63-0119	Curved Right	4 mm	8 $\frac{1}{4}$ in 210 mm



63-0120

### Converse Osteotome

CODE	DESCRIPTION	LENGTH
67-3102	2 mm	7 in 175 mm
67-3104	4 mm	7 in 175 mm
67-3106	6 mm	7 in 175 mm
67-3108	8 mm	7 in 175 mm
67-3110	10 mm	7 in 175 mm
67-3112	12 mm	7 in 175 mm



67-3102

### Cottle Osteotome

Very Delicate, Round Corners

CODE	DESCRIPTION	LENGTH
63-0103	4 mm Wide	7 in 175 mm
63-0104	6 mm Wide	7 in 175 mm
63-0105	9 mm Wide	7 in 175 mm
63-0106	12 mm Wide	7 in 175 mm

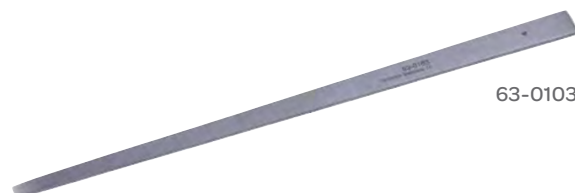

63-0103

## Osteotomes

### Neivert Osteotome

CODE	DESCRIPTION	GENERATOR PLUG	LENGTH
63-0121	Straight	With 4 mm Single Guarded Edge	8 in 200 mm



### Osteotome

CODE	TIP WIDTH	LENGTH
63-0092	2 mm	6 ¼ in 160 mm
63-0093	3 mm	6 ¼ in 160 mm
63-0094	4 mm	6 ¼ in 160 mm
63-0095	5 mm	6 ¼ in 160 mm
63-0096	6 mm	6 ¼ in 160 mm
63-0097	7 mm	6 ¼ in 160 mm
63-0098	8 mm	6 ¼ in 160 mm
63-0099	9 mm	6 ¼ in 160 mm
63-0100	10 mm	6 ¼ in 160 mm
63-0101	11 mm	6 ¼ in 160 mm
63-0102	12 mm	6 ¼ in 160 mm



63-0092

### Ristow Osteotome

CODE	DESCRIPTION	LENGTH
63-0122	Curved Right	8 in 200 mm



### Rubin Osteotome

Rounded Corners with Finger Guard

CODE	DESCRIPTION	LENGTH
63-0107	10 mm Width, With 8 mm Cutting Edge	6 ½ in 165 mm
63-0108	14 mm Width, With 12 mm Cutting Edge	6 ½ in 165 mm
63-0109	16 mm Width, With 14 mm Cutting Edge	6 ½ in 165 mm



63-0108



## Osteotomes

### Silver Osteotome

5.0 mm Wide Angled Blade with Single Guarded Edge

CODE	DESCRIPTION	LENGTH	
67-3810	Straight	7¼ in	185 mm
67-3811	Right	7¼ in	185 mm
67-3812	Left	7¼ in	185 mm



### Tessier Osteotome

CODE	DESCRIPTION	WIDTH	LENGTH
63-0151	Straight	3.5 mm	6¼ in 160 mm



## Osteotomes (Guarded)

### Cinelli Double Guarded Osteotome

CODE	TIP WIDTH	LENGTH
63-3710	10 mm	6 in 150 mm
63-3712	12 mm	6 in 150 mm
63-3714	14 mm	6 in 150 mm
63-3716	16 mm	6 in 150 mm



### Converse Single Guarded Osteotome

CODE	DESCRIPTION	WIDTH	EDGE	LENGTH
63-0117	Straight	6 mm		7½ in 190 mm
63-0116	Curved Left	6 mm		7½ in 190 mm
63-0115	Curved Right	6 mm	4.5 mm	7½ in 190 mm



### Cottle Guarded Osteotome

CODE	DESCRIPTION	WIDTH	LENGTH
63-0118	Straight	6 mm	7½ in 190 mm



## Osteotomes (Guarded)

### Fomon Guarded Osteotome

CODE	TIP WIDTH	LENGTH
63-0112	7 mm	6 ½ in 165 mm



## Picks (Middle Ear)

### House-Barbara Pick

CODE	DESCRIPTION	LENGTH
61-0365	Straight Tip, Malleable Shaft	6 ½ in 165 mm



### Shea Pick

CODE	DESCRIPTION	LENGTH
61-0483	Blunt	6 ½ in 160 mm

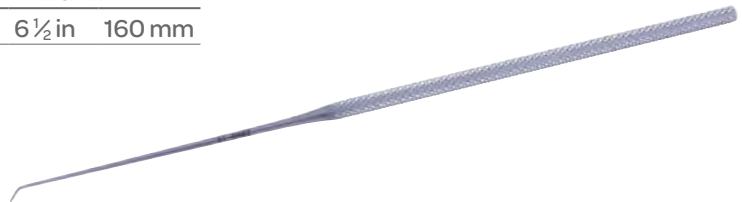

### House-Crabtree Dissector Pick "Jimmy"

Flat Tip, Angled 90°

CODE	DESCRIPTION	LENGTH
61-0392	Small 0.8 x 1.5 mm	6 ½ in 165 mm
61-0391	Large 0.5 x 2.5 mm	6 ½ in 165 mm



61-0391

## Picks (Middle Ear)

### Hough Foot Plate Pick

Slightly Curved Tip

CODE	DESCRIPTION	LENGTH
61-0336	Fine Pattern	6 in 150 mm
61-0335	Heavy Pattern	6 in 150 mm



### Hough "Hoe" Pick

0.5 mm Tip, Angled Shaft

CODE	DESCRIPTION	LENGTH
61-0351	Tip Angled 45°	6 in 150 mm
61-0340	Tip Angled 90°	6 in 150 mm



### House Obtuse Pick

CODE	DESCRIPTION	LENGTH
61-0371	0.33 mm Tip, Angled 30°	6½ in 165 mm



### House Oval Window Pick

CODE	DESCRIPTION	LENGTH
61-0373	0.33 mm Tip, Medium Shaft, Tip Angled 90°	6½ in 165 mm
61-0383	0.33 mm Tip, Angled 30° on Straight Malleable Shaft	6½ in 165 mm
61-0384	0.66 mm Long Tip, Angled 30° on Straight Malleable Shaft	6½ in 165 mm

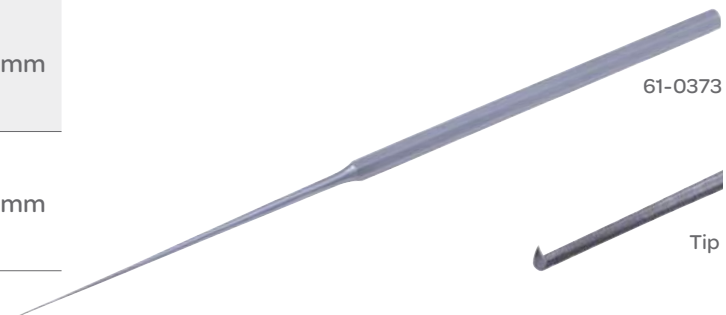

## Picks (Middle Ear)

### Hough Stapedectomy Pick

CODE	DESCRIPTION	LENGTH
61-0338	0.33 mm tip, Angled Shaft 90°	6 in 150 mm



### House Strut Pick

Malleable Medium Shaft

CODE	DESCRIPTION	TIP	LENGTH
61-0374	Angled 90°	0.5 mm	6½ in 165 mm
61-0375	Angled 90°	0.66 mm	6½ in 165 mm



### House Window Pick

Fine shaft

CODE	DESCRIPTION	LENGTH
61-0372	0.33 mm, Angled 90°	6½ in 165 mm

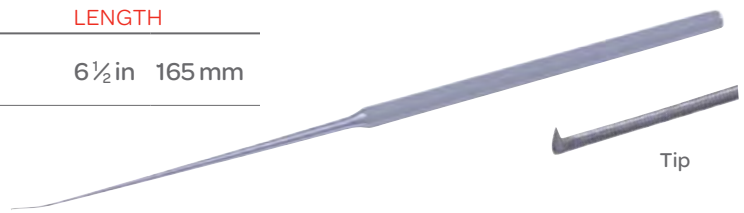

### Austin Pick

CODE	ANGLE	GENERATOR PLUG	LENGTH
61-0317	25°	1 mm Tip	6¼ in 160 mm
61-0306	45°	1 mm Wide Tip	6¼ in 160 mm
61-0308	90°	1 mm Wide Tip	6¼ in 160 mm
61-0307	90°	3 mm Wide Tip	6¼ in 160 mm

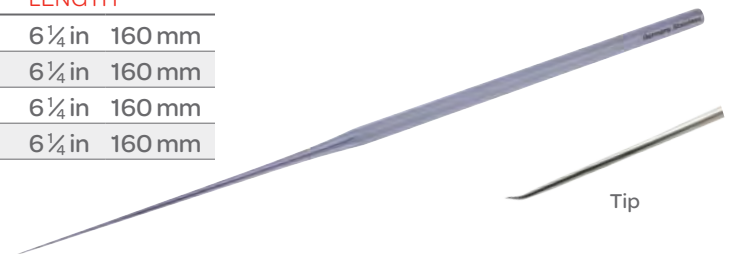

## Picks (Middle Ear)

### McGee Pick

CODE	DESCRIPTION	POINT	LENGTH
61-0425	Anterior Angled 90° Up	0.2 mm	6½ in 165 mm
61-0426	Posterior Angled 90° Down	0.2 mm	6½ in 165 mm



61-0425

### Paparella Pick

CODE	DESCRIPTION	BLADE	LENGTH
61-3812	Angled Left	1 x 4 mm	6½ in 165 mm
61-3810	Angled Right	1 x 4 mm	6½ in 165 mm



61-3812

### Rosen Pick

CODE	DESCRIPTION	LENGTH
61-0445	Curved Tip	6½ in 165 mm
61-0446	Angled Tip	6½ in 165 mm



61-0445

Tip

### Hough Pick

Straight Malleable Heavy Shaft

CODE	DESCRIPTION	LENGTH
61-0349	Straight Tip	6 in 150 mm
61-0387	1 mm Tip	6½ in 165 mm
61-0388	1.5 mm Tip	6½ in 165 mm
61-0389	3 mm Tip	6½ in 165 mm



61-0349

## Picks (Middle Ear)

### Kos Pick

CODE	DESCRIPTION	LENGTH
61-7723	Bayonet Shaft, 0.33 mm Point 90°	7 in 180 mm



## Presses

### Sheehy Fascia Press

CODE	GENERATOR PLUG	LENGTH
61-0517	23 x 31 mm Plate	7½ in 190 mm



### House Gelfoam Press

CODE	DESCRIPTION	LENGTH
61-0518	16 x 12 mm Plate	7½ in 190 mm
61-0519	16 x 12 mm plate	5 in 130 mm



61-0519

## Probes (Laryngeal)



### Jako Laryngeal Probe

CODE	DESCRIPTION	WORKING LENGTH	LENGTH
74-4520	Straight	8 <sup>5</sup> / <sub>8</sub> in 220 mm	11 <sup>5</sup> / <sub>8</sub> in 295 mm
74-4521	Angled	8 <sup>5</sup> / <sub>8</sub> in 220 mm	11 <sup>5</sup> / <sub>8</sub> in 295 mm

## Probes (Periodontal)



### Periodontal Probe

CODE	DESCRIPTION	LENGTH
69-6218	Dental Probe	6 in 152 mm

## Probes (Sinus)

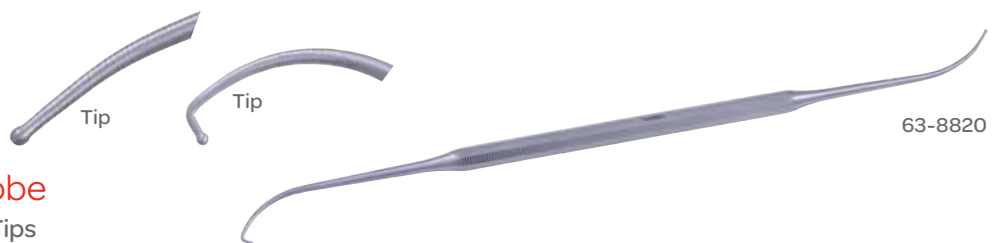

### Ostium Seeker Probe

With Double-Ended Ball Tips

CODE	DESCRIPTION	ANGLE	BALL TIPS	LENGTH
63-8820	Frontal Sinus	One End 90°		8 <sup>1</sup> / <sub>4</sub> in 210 mm
63-8825	Maxillary Sinus		2.3 and 2.6 mm	8 <sup>1</sup> / <sub>4</sub> in 210 mm

## Probes (Sinus)

### Skillern Sinus Probe

CODE	DESCRIPTION	LENGTH
09-1300	Malleable with Centimeter Graduations at 50 mm, 70 mm and 90 mm	6 1/2 in 165 mm

## Punches (Sinus)



### Access Down Biting Punch

CODE	DESCRIPTION	DIAMETER	WORKING LENGTH
11-311	90° Down Biter, Left	3.8 mm	4 5/8 in 115 mm
11-321	90° Down Biter, Right	3.8 mm	4 5/8 in 115 mm

## Punches (Adenoid)



### King Adenoid Punch

CODE	DESCRIPTION	BITE	BASKET	LENGTH
72-6179	Triangular Basket	6 mm	7 mm	7 in 175 mm



## Punches (Adenoid)



### Meltzer Adenoid Punch

CODE	DESCRIPTION	BASKET	SHAFT	BITE	LENGTH
71-4001	#1	6 mm, Round	120 mm	5 mm	8 ¼ in 210 mm
71-4002	#2	7 mm, Round	120 mm	7 mm	8 ¼ in 210 mm



### Ronis Adenoid Punch

CODE	DESCRIPTION	SIZE	LENGTH
71-5001	#1, Triangular Basket, Curved Up, Shaft 120 mm	7 mm Basket	8 ¼ in 210 mm
71-5002	#2, Triangular Basket, Curved Up, Shaft 120 mm	8 mm Basket	8 ¼ in 210 mm



### Meltzer Adenoid Punch

CODE	DESCRIPTION	BASKET	SHAFT	BITE	LENGTH
71-5220	#0	5 mm, Triangular	120 mm	4 mm	7 ¾ in 197 mm
71-5222	#1	7 mm, Triangular	120 mm	6 mm	7 ¾ in 197 mm

## Punches (Sinus & Nasal)

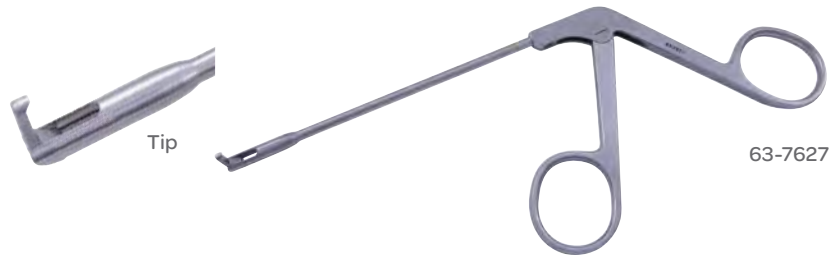

### Backbiting Antrum Punch

Adult, 2.5 x 7 mm Bite, Shaft 90 mm

CODE	DESCRIPTION	LENGTH
63-7625	Straight	7 <sup>3</sup> / <sub>8</sub> in 187 mm
63-7627	Left Side Cutting	7 <sup>3</sup> / <sub>8</sub> in 187 mm
63-7626	Right Side Cutting	7 <sup>3</sup> / <sub>8</sub> in 187 mm



### Antrum Cutting Punch

CODE	DESCRIPTION	BITE	LENGTH
63-7610	45° Backward Cutting	4 x 5 mm	8 <sup>1</sup> / <sub>4</sub> in 210 mm
63-7615	45° Forward Cutting	4 x 5 mm	8 <sup>1</sup> / <sub>4</sub> in 210 mm
63-7631	90° Down Cutting	4 x 8 mm	8 <sup>1</sup> / <sub>4</sub> in 210 mm
63-7630	90° Up Cutting	4 x 8 mm	8 <sup>1</sup> / <sub>4</sub> in 210 mm



### Circular Cutting Antrum Punch

Allows Cutting 360° without Rotating the Instrument

CODE	DESCRIPTION	BITE	SHAFT
63-7453	Straight	3.5 mm	7 in 180 mm
63-7454	Straight	4.5 mm	7 in 180 mm
63-7455	65° Degree Upturn	3.5 mm	6 <sup>3</sup> / <sub>4</sub> 170 mm

## Punches (Sinus & Nasal)

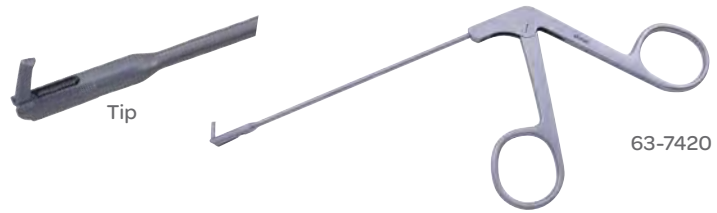

63-7420

### Pediatric Backbiting Antrum Punch

CODE	DESCRIPTION	BITE	SHAFT	LENGTH
63-7420	Straight	1.5 x 5 mm	4 1/8 in 105 mm	8 1/4 in 210 mm
63-7422	Left Side Cutting	1.5 x 5 mm	4 1/8 in 105 mm	8 1/4 in 210 mm
63-7421	Right Side Cutting	1.5 x 5 mm	4 1/8 in 105 mm	8 1/4 in 210 mm

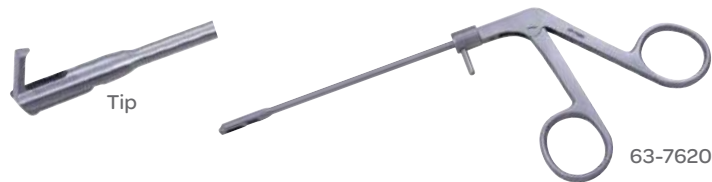

63-7620

### Rotating Backbiting Antrum Punch

With Post for One Hand Rotation of 360°

CODE	DESCRIPTION	BITE	SHAFT	LENGTH
63-7415	Pediatric	1.5 x 5 mm	100 mm	8 in 203 mm
63-7416	Pediatric	1.5 x 5 mm	100 mm	8 1/2 in 215 mm
63-7620	Adult	2.5 x 7 mm	100 mm	8 in 200 mm



63-7452

### Side Biting Antrum Punch

Thru-Punch, Designed to Cut Down, Right, Left and Forward

CODE	DESCRIPTION	SHAFT	LENGTH
63-7452	Left Side Cuts Down and Sideways	3 7/8 in 100 mm	8 1/2 in 215 mm
63-7451	Right Side Cuts Down and Sideways	3 7/8 in 100 mm	8 1/2 in 215 mm



11-301

### Access Small Punch

CODE	DESCRIPTION	DIAMETER	WORKING LENGTH
11-301	Straight	3.3 mm	3 7/8 in 97 mm
11-341	Up 45°	3.3 mm	3 3/5 in 94 mm

## Punches (Sinus & Nasal)



Tip



11-302

### Access Medium Punch

CODE	DESCRIPTION	DIAMETER	WORKING LENGTH
11-302	Straight	4 mm	3 7/8 in 97 mm
11-342	Up 45°	4 mm	3 3/8 in 94 mm



Tip



11-303

### Access Large Punch

CODE	DESCRIPTION	DIAMETER	WORKING LENGTH
11-303	Straight	6.1 mm	4 in 100 mm
11-343	Up 45°	6.1 mm	3 7/8 in 97 mm



### Hajek-Kofler Punch

CODE	DESCRIPTION	JAWS	SHAFT	LENGTH
66-3810	360° Rotatable	3 x 7 mm Solid Biting	5 7/8 in 150 mm	9 1/2 in 240 mm



Tip



11-303

### Access Suction Punch

CODE	DESCRIPTION	DIAMETER	WORKING LENGTH
11-402	Straight	4 mm	3 5/8 in 93 mm
11-442	Up 45°	4 mm	3 5/8 in 93 mm

## Punches (Sinus & Nasal)

### Access Toffel Punch

Thru-Cutting



11-371

CODE	DESCRIPTION	DIAMETER	WORKING LENGTH
11-371	Left	3 mm	3 7/8 in 97 mm
11-372	Right	3 mm	3 7/8 in 97 mm

## Punches (Sphenoid)

### McKenty Sphenoid Punch



CODE	DESCRIPTION	JAWS	SHAFT	LENGTH
66-3812	360° Rotatable	1.5 x 4 mm Thru-Biting	5 5/8 in 145 mm	7 in 175 mm

### Sphenoid Punch



11-502

CODE	DESCRIPTION	WORKING LENGTH
11-502	3.5 mm	4 1/2 in 115 mm
11-504	4.5 mm	4 1/2 in 115 mm

## Rasps (Bone & Skin)

### Bone & Skin Rasp

CODE	DESCRIPTION	LENGTH
26-0513	Bone and Skin Rasp	5 1/8 in 130 mm

## Rasps (Middle Ear)



61-0429

### McGee Oval Window Rasp

CODE	DESCRIPTION	ANGLE	DIAMETER	LENGTH
61-0429	Small	20°	0.4 mm	6 ½ in 165 mm
61-0430	Large	20°	0.7 mm	6 ½ in 165 mm

## Rasps (Nasal)



67-5941

### Aufricht Nasal Rasp

CODE	WIDTH	CUTTING DIRECTION	LENGTH
67-5941	8 mm	Down-Cutting	8 ¼ in 210 mm
67-5942	8 mm	Up-Cutting	8 ¼ in 210 mm



Tip

### Fomon Nasal Rasp

CODE	DESCRIPTION	LENGTH
67-5960	Double-Ended, with 4 Working Surfaces, 2 Surfaces with Fine and 2 with Coarse Serrations, Flat and Convex	8 ¾ in 220 mm

### Peet Nasal Rasp

CODE	DESCRIPTION	LENGTH
63-0560	Straight, Fine Tungsten Carbide Dust Surface	7 ½ in 190 mm

## Rasps (Sinus & Nasal)

### Good Antrum Rasp

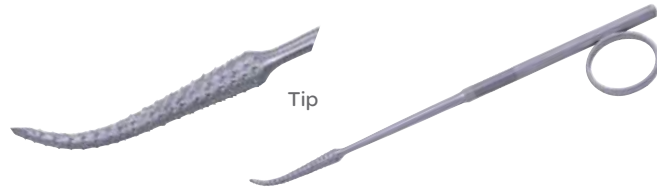

CODE	LENGTH
67-5920	6¾ in 170 mm

### Wiener Antrum Rasp



66-6233

CODE	TIP	LENGTH
66-6232	Extra-Small Trocar	7½ in 190 mm
66-6234	Small Trocar	7½ in 190 mm
66-6233	Large Trocar	7½ in 190 mm

### Dingman Otoabrader Rasp

10 Fine Teeth

CODE	DESCRIPTION	LENGTH
67-5912	Curved Left	6¼ in 160 mm
67-5911	Curved Right	6¼ in 160 mm



60-6054

### Obwegeser Push Pull Rasp

One Working End Operates by Pushing, the Other End by Pulling

CODE	DESCRIPTION	LENGTH
67-6051	Straight, Delicate	7½ in 190 mm
67-6052	Straight, Medium/Fine	7½ in 190 mm
67-6053	Curved, Delicate	7½ in 190 mm
67-6054	Curved, Medium/Fine	7½ in 190 mm
67-6055	Concave, Delicate	7½ in 190 mm
67-6056	Concave, Medium/Fine	7½ in 190 mm

## Rasps (Sinus & Nasal)

### Tungsten Carbide Rasp

Straight, Double-Ended, Down-Cutting



CODE	DESCRIPTION	LENGTH
63-0516	Very Fine Grit #1 and Fine Grit #2	8 ¼ in 210 mm
63-0518	Fine Grit #3 and Coarse Grit #4	8 ¼ in 210 mm
63-0520	Coarse Grit #5 and Coarse Grit #6	8 ¼ in 210 mm
63-0522	Coarse Grit #7 and Very Coarse Grit #8	8 ¼ in 210 mm

### Aufricht-Glabella Rasp



CODE	DESCRIPTION	LENGTH
67-5940	Curved Backwards, Cross Serrated, Up - and Down-Cutting	7 ½ in 190 mm

### Cottle Rasp

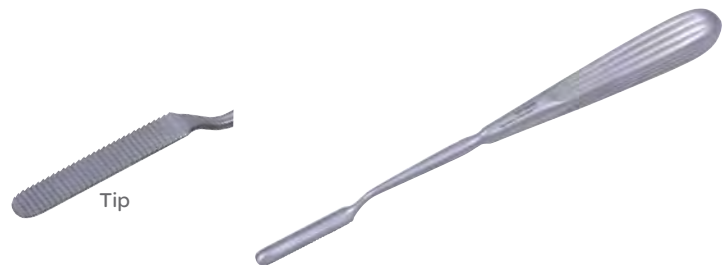

CODE	DESCRIPTION	LENGTH
67-5935	24 Straight, Fine, Down-Cutting Teeth	8 ¼ in 210 mm

### Fomon Rasp

Double-Ended Convex and Flat Ends, Down-Cutting



CODE	DESCRIPTION	LENGTH
63-0511	Fine Teeth	8 ⅜ in 212 mm
63-0512	Coarse Teeth	8 ⅜ in 212 mm



## Rasps (Sinus & Nasal)



63-0503

### Joseph Rasp

CODE	DESCRIPTION	WIDTH	LENGTH
63-0503	Fine, Single-Ended	2 mm Wide	7¼ in 185 mm
63-0504	Course, Single-Ended	2 mm Wide	7¼ in 185 mm

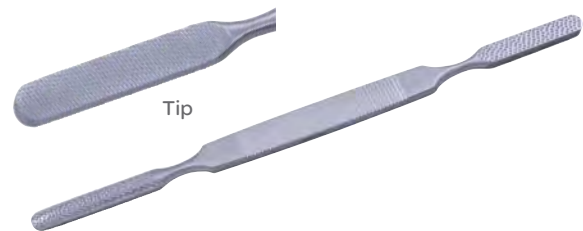

Tip

### Kleinert-Kutz Rasp

Double-Ended with One Flat End and One Convex End

CODE	DESCRIPTION	LENGTH
67-5970	Coarse Teeth on One Side and Fine Teeth on the Other Side	8½ in 215 mm

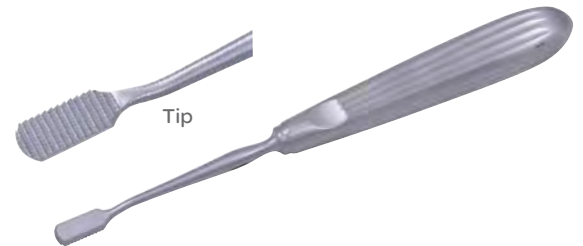

Tip

### Lewis Rasp

CODE	DESCRIPTION	LENGTH
67-5930	Down-Cutting Teeth	7 in 175 mm

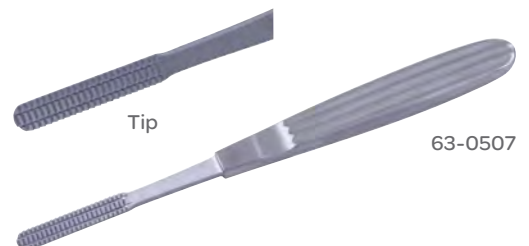

Tip

63-0507

### Maltz Rasp

CODE	DESCRIPTION	LENGTH
63-0507	Down-Cutting Pattern	6½ in 165 mm
63-0508	Up-Cutting Pattern	6½ in 165 mm

## Rasps (Sinus & Nasal)



### Maltz Rasp

Fine Tungsten Carbide Inserts

63-0551

CODE	DESCRIPTION	LENGTH	
63-0551	Down-Cutting Pattern	7 in	170 mm
63-0550	Up-Cutting Pattern	7 in	170 mm

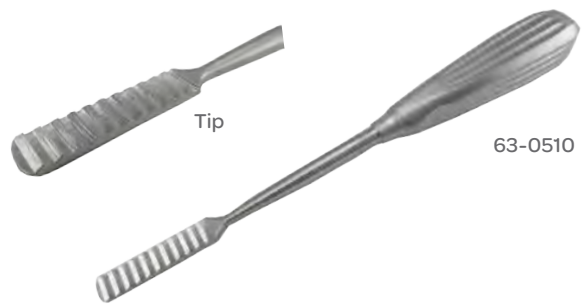

### Parkes Rasp

Down-Cutting

63-0510

CODE	DESCRIPTION	LENGTH	
63-0509	20 Fine, Concave Teeth	7 3/4 in	195 mm
63-0510	11 Coarse, Concave Teeth	7 3/4 in	195 mm



63-0498

### Rasp

Fine Tungsten Carbide Dust Teeth

CODE	DESCRIPTION	SURFACE	LENGTH	
63-0500	Straight	Convex	7 1/2 in	190 mm
63-0501	Straight	Concave	7 1/2 in	190 mm
63-0505	Straight	Concave	7 1/2 in	190 mm
63-0506	Curved	Convex	7 1/2 in	190 mm
63-0494	Curved Backwards	Convex	7 1/2 in	190 mm
63-0495	Curved Backwards	Concave	7 1/2 in	190 mm
63-0496	Curved Backwards	Flat	7 1/2 in	190 mm
63-0498	Curved Forward	Convex	7 1/2 in	190 mm
63-0498	Curved Forward	Concave	7 1/2 in	190 mm
63-0499	Curved Forward	Flat	7 1/2 in	190 mm

## Retractors (Cheek)

### Cheek Retractor



CODE	DESCRIPTION	LENGTH
72-0240	With Swivel	8¼ in 209 mm

## Retractors (Hand-Held)

### Aufricht Retractor



67-2135

CODE	WIDTH	LENGTH
67-2135	45 mm	7⅞ in 180 mm
67-2136	60 mm	7⅞ in 180 mm
67-2137FO	70 mm, Fiber Optic Light Guide	7 in 175 mm

### Blair (Rollet) Retractor

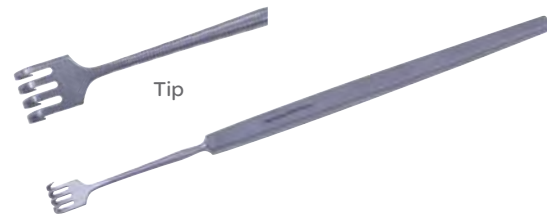

Tip

CODE	WIDTH	PRONGS	LENGTH
63-4010	6 mm	4 Sharp	5 in 125 mm

### Cottle Retractor

Double-Prong, One Sharp and One Ball Tip



Tip

67-2021

CODE	DESCRIPTION	LENGTH
67-2021	Right Prong, Sharp	5½ in 140 mm
67-2022	Left Prong, Sharp	5½ in 140 mm

## Retractors (Hand-Held)

### Cottle-Neivert Retractor

Knife Guide and Retractor



67-2052

CODE	DESCRIPTION	PRONGS	WIDTH	LENGTH
67-2051	Double-Ended	Ball		7 3/4 in 195 mm
67-2052	Double-Ended	Blunt	10 mm	8 1/4 in 210 mm

### Crile Retractor



CODE	DESCRIPTION	LENGTH
20-0930	Double-Ended	4 3/8 in 110 mm

### Heiss Retractor



24-0909

CODE	PRONGS	LENGTH
24-0909	4 x 4 Prongs, Sharp	4 in 100 mm
24-0910	4 x 4 Prongs, Blunt	4 in 100 mm

EAR, NOSE & THROAT

## Retractors (Tracheal)

### Jackson Tracheal Tenaculum



CODE	DESCRIPTION	LENGTH
20-4014	Single Prong	5 3/4 in 145 mm

## Retractors (Hand-Held)



### Knapp Retractor

CODE	WIDTH	PRONGS	LENGTH
20-5516	6 mm	4 Sharp	5 in 125 mm
20-5517	6 mm	4 Blunt	5 in 125 mm



### Murphy Retractor

CODE	PRONGS	LENGTH
22-5002	2 Sharp	7 <sup>3</sup> / <sub>4</sub> in 195 mm
22-5004	4 Sharp	7 <sup>3</sup> / <sub>4</sub> in 195 mm
22-5006	6 Sharp	7 <sup>3</sup> / <sub>4</sub> in 195 mm
22-5102	2 Blunt	7 <sup>3</sup> / <sub>4</sub> in 195 mm
22-5103	3 Blunt	7 <sup>3</sup> / <sub>4</sub> in 195 mm
22-5104	4 Blunt	7 <sup>3</sup> / <sub>4</sub> in 195 mm
22-5106	6 Blunt	7 <sup>3</sup> / <sub>4</sub> in 195 mm



### Perkins Retractor

Three Sharp Prongs and Solid Blades with Spikes

CODE	DESCRIPTION	SPREAD	LENGTH
66-6650	3 Prongs on Left with Solid Blade Right	5 in 125 mm	5 in 125 mm
66-6651	3 Prongs on Right with Solid Blade Left	5 in 125 mm	5 in 125 mm

### Ragnell Retractor

Double-Ended



CODE	BLADES	LENGTH
20-0525	2.5 mm 5 mm	6 <sup>1</sup> / <sub>4</sub> in 160 mm

## Retractors (Tracheal)

### Ragnell Retractor

Double-Ended



CODE	BLADES	LENGTH
20-0526	3 mm 5 mm	6 ¼ in 160 mm

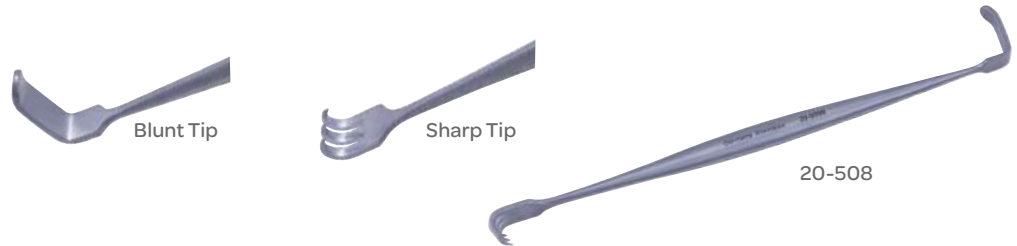

### Senn Retractor

Double-Ended

CODE	PRONGS	LENGTH
20-0508	Sharp	6 ¼ in 160 mm
20-0509	Blunt	6 ¼ in 160 mm



### Volkman Retractor

CODE	PRONGS	LENGTH
22-3402	2 Sharp	8 ¾ in 220 mm
22-3403	3 Sharp	8 ¾ in 220 mm
22-3404	4 Sharp	8 ¾ in 220 mm
22-3406	6 Sharp	8 ¾ in 220 mm
22-3502	2 Blunt	8 ¾ in 220 mm
22-3503	3 Blunt	8 ¾ in 220 mm
22-3504	4 Blunt	8 ¾ in 220 mm
22-3506	6 Blunt	8 ¾ in 220 mm

## Retractors (Hook, Tracheal, Middle Ear)



### Fomon Hook Retractor

CODE	DESCRIPTION	WIDTH	LENGTH
67-2025	Ball Tipped Prongs	13 mm	6 <sup>3</sup> / <sub>4</sub> in 170 mm



### Jackson Tracheal Retractor

CODE	DESCRIPTION	LENGTH
20-0708	Double-Ended	6 <sup>3</sup> / <sub>4</sub> in 170 mm



### Endaural Retractor

CODE	DESCRIPTION	WORKING LENGTH	OVERALL LENGTH
61-0601	T-Model	3 in 76 mm	4 <sup>1</sup> / <sub>4</sub> in 108 mm



### House Hand Retractor

CODE	DESCRIPTION	LENGTH
61-0600	5 x 16 mm and 9 x 25 mm Blades	6 in 150 mm

## Retractors (Middle Ear, Nasal)

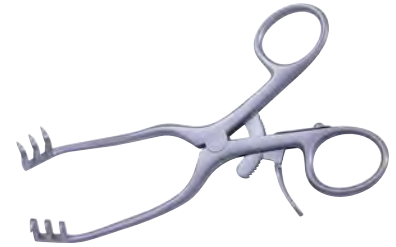

### Schuknecht Retractor

CODE	DESCRIPTION	PRONGS	LENGTH
24-2620	Double Curved Arms	3 x 3 Sharp	5 1/8 in 130 mm

### Schuknecht Retractor

CODE	DESCRIPTION	PRONGS	DEEP	LENGTH
24-2625	Arms Curved Downwards	3 x 3 Sharp	17 mm	5 1/8 in 130 mm



61-0605

### Bellucci-Wullstein Retractor

CODE	DESCRIPTION	BLADE	PRONGS	LENGTH
61-0605	Solid Blade on Right	10 x 20 mm	Two Blunt	5 in 125 mm
61-0606	Solid Blade on Left	10 x 20 mm	Two Blunt	5 in 125 mm



63-4022

### Converse Nasal Retractor

CODE	LENGTH
63-4022	4 3/8 in 112 mm



## Retractors (Tonsil & Laryngeal)



### Hurd Dissector & Pillar Retractor

CODE	DESCRIPTION	LENGTH
72-2522	7 mm Dissector, 11 mm Retractor	8½ in 215 mm

## Retractors (Nasal)



### Cottle Nasal Retractor

CODE	WIDTH	PRONGS	LENGTH
67-2044	10 mm	4 Blunt	6 in 150 mm

## Retractors (Orbital)



### Sewall Orbital Retractor

CODE	BLADE	LENGTH
63-4003	7x52 mm	6¾ in 170 mm
63-4004	9x51 mm	6¾ in 170 mm
63-4005	11x50 mm	6¾ in 170 mm

## Retractors (Scalp)



### Jansen Scalp Retractor

CODE	PRONGS	LENGTH
24-1310	3x3 Sharp	4 in 100 mm
24-1320	3x3 Blunt	4 in 100 mm
24-1321	4x4 Blunt	4 in 100 mm

## Retractors (Self-Retaining)

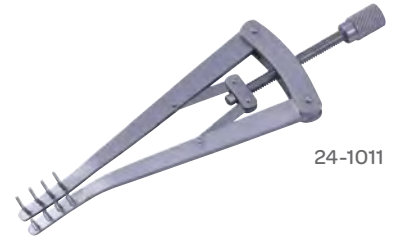

24-1011

### Alm Retractor

CODE	PRONGS	LENGTH
24-1007	4 x 4 Sharp	2 <sup>3</sup> / <sub>4</sub> in 70 mm
24-1010	4 x 4 Sharp	4 in 100 mm
24-1008	4 x 4 Blunt	2 <sup>3</sup> / <sub>4</sub> in 70 mm
24-1011	4 x 4 Blunt	4 in 100 mm



### Pediatric Weitlaner Retractor

CODE	PRONGS	LENGTH
61-0610	3 x 3 Blunt	4 <sup>1</sup> / <sub>2</sub> in 115 mm

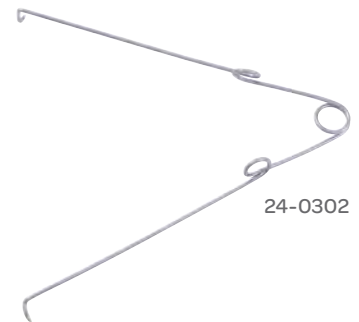

24-0302

### Spring Retractor

CODE	PRONGS	DESCRIPTION	LENGTH
24-0301	1x1 Sharp		3 <sup>1</sup> / <sub>2</sub> in 90 mm
24-0302	1x1 Sharp		4 <sup>1</sup> / <sub>2</sub> in 115 mm
24-0352	1x1 Sharp	With Ratchet	4 <sup>1</sup> / <sub>8</sub> in 105 mm
24-0303	3 x 3 Blunt		3 <sup>1</sup> / <sub>2</sub> in 90 mm
24-0304	3 x 3 Blunt		4 <sup>1</sup> / <sub>2</sub> in 115 mm

## Retractors (Self-Retaining)



24-2210

### Weitlaner Retractor

CODE	PRONGS	LENGTH
24-2210	2 x 3, Sharp	4 ½ in 115 mm
24-2213	3 x 4, Sharp	5 ½ in 140 mm
24-2216	3 x 4, Sharp	6 ½ in 165 mm
24-2220	3 x 4, Sharp	8 in 200 mm
24-2224	3 x 4, Sharp	9 in 230 mm
24-2211	2 x 3, Blunt	4 ½ in 115 mm
24-2214	3 x 4, Blunt	5 ½ in 140 mm
24-2217	3 x 4, Blunt	6 ½ in 165 mm
24-2221	3 x 4, Blunt	8 in 200 mm
24-2225	3 x 4, Blunt	9 in 230 mm



24-2614

### Wullstein-Weitlaner Retractor

CODE	DESCRIPTION	PRONGS	DEEP	LENGTH
24-2613	Arms Angled Downwards	3 x 3 Sharp	12 mm	5 ⅛ in 130 mm
24-2614	Arms Angled Downwards	3 x 3 Blunt	12 mm	5 ⅛ in 130 mm

### Converse Alar Retractor



CODE	DESCRIPTION	WIDTH	LENGTH
67-2010	Double-Ended, Sharp	10 mm and 14 mm	4 ¾ in 120 mm

## Retractors (Sinus & Nasal)

### Cottle Alar Retractor



CODE	DESCRIPTION	LENGTH
67-2115	Tapered End 16 mm–13 mm	5½ in 140 mm

### Converse Blade Retractor



63-4017

CODE	DESCRIPTION	LENGTH
63-4017	9 x 18 mm	3¾ in 95 mm
63-4018	12 x 21 mm	3¾ in 95 mm
63-4019	12 x 38 mm	3¾ in 95 mm
63-4020	12 x 53 mm	3¾ in 95 mm

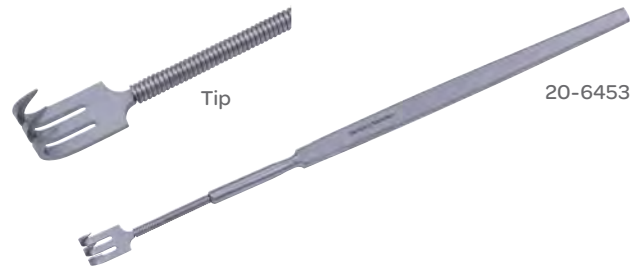

Tip

20-6453

### Flexible Neck Retractor

CODE	PRONGS	LENGTH
20-6452	2 Sharp	6¼ in 160 mm
20-6453	3 Sharp	6¼ in 160 mm
20-6552	2 Blunt	6¼ in 160 mm
20-6553	3 Blunt	6¼ in 160 mm

## Retractors (Thymus)



Lukens Thymus Retractor

CODE	DESCRIPTION	LENGTH
20-0707	Double-Ended	6 <sup>3</sup> / <sub>4</sub> in 170 mm

## Retractors (Thyroid)



Green Thyroid Retractor

CODE	DESCRIPTION	LENGTH
23-3512	Fenestrated Blade	8 <sup>1</sup> / <sub>2</sub> in 215 mm



Lahey Thyroid Retractor

CODE	DESCRIPTION	LENGTH
23-0306	6 mm x 3 mm	7 <sup>3</sup> / <sub>4</sub> in 195 mm

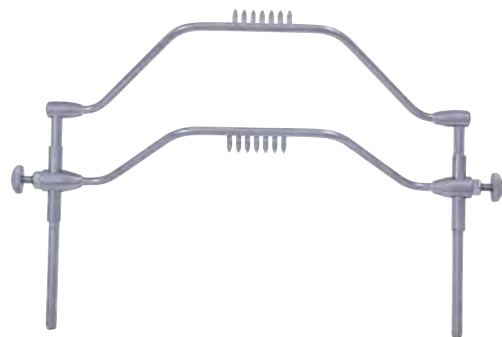

Mahorner Thyroid Retractor

CODE	DESCRIPTION	LENGTH
24-0888	7 Prong, 4 in, 100 mm Spread	10 <sup>1</sup> / <sub>2</sub> in 265 mm

## Retractors (Uvula)

### Goodyear Uvula Retractor



CODE	DESCRIPTION	LENGTH
71-6348	15 mm	7 ½ in 190 mm

### Lothrop Uvula Retractor

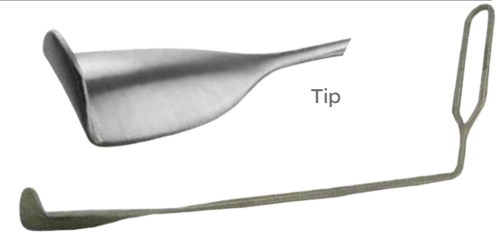

CODE	DESCRIPTION	LENGTH
71-6360	17 x 20 mm	8 in 200 mm

### Love Uvula Retractor



CODE	WIDTH	LENGTH
71-6318	18 mm	6 ½ in 165 mm
71-6320	20 mm	6 ½ in 165 mm

## Retractors (Vein)

### Cushing Vein Retractor



CODE	WIDTH	LENGTH
20-1708	8 mm	8 in 200 mm
20-1710	10 mm	8 in 200 mm
20-1712	12 mm	8 in 200 mm
20-1714	14 mm	8 in 200 mm
20-1716	16 mm	8 in 200 mm
20-1718	18 mm	8 in 200 mm

## Retractors (Cheek & Tongue)



### University of Minnesota Cheek Retractor & Tongue Depressor

CODE	LENGTH
72-0210	5½ in 140 mm

## Rongeurs (Bone)

### Beyer Bone Rongeur

CODE	DESCRIPTION	JAWS	LENGTH
30-7102	Slender	2 mm	6¾ in 170 mm
30-7103	Slender	3 mm	7 in 175 mm



30-7103

### Friedman Bone Rongeur

CODE	DESCRIPTION	JAWS	LENGTH
30-0514	Delicate	4 x 11 mm	5½ in 140 mm
30-0516	Curved	4 x 11 mm	5½ in 140 mm

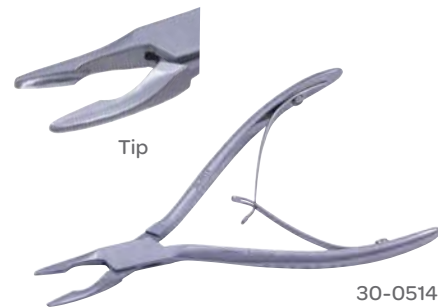

30-0514

### Micro Friedman Rongeur

Very Delicate

CODE	DESCRIPTION	JAWS	LENGTH
30-0201	Straight	1.3 mm	5½ in 140 mm
30-0203	Straight	2 mm	5½ in 140 mm
30-0202	Curved	1.3 mm	5½ in 140 mm
30-0204	Curved	2 mm	5½ in 140 mm

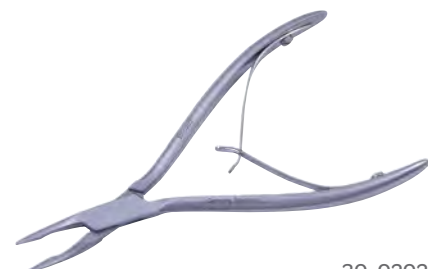

30-0202

## Rongeurs (Bone)

### Jansen Bone Rongeur

CODE	DESCRIPTION	JAWS	LENGTH
30-5018	Straight	4 mm	7 in 175 mm
30-5118	Curved	4 mm	7 in 175 mm



31-5018

### Ruskin-Mini Bone Rongeur

Double Action

CODE	DESCRIPTION	JAWS	LENGTH
31-0402	Straight	2 mm	6 in 150 mm
31-0502	Straight	2 mm	6 in 150 mm
31-0403	Curved	3 mm	6 in 150 mm
31-0503	Curved	3 mm	6 in 150 mm

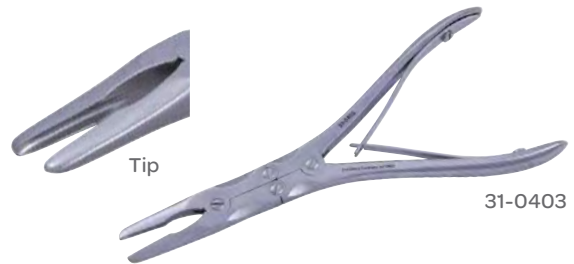

31-0403

## Rongeurs (Kerrison)

### Kerrison Rongeur

CODE	DESCRIPTION	LENGTH
62-6203	#0 3 mm Bite	6 3/4 in 170 mm
62-6204	#1 4 mm Bite	6 3/4 in 170 mm
62-6205	#2 5 mm Bite	6 3/4 in 170 mm
62-6206	#3 6 mm Bite	6 3/4 in 170 mm



62-6203

### Kerrison-Costen Rongeur

90° Bite on Curved Shaft

CODE	SHAFT	LENGTH
63-5010	102 mm 3x3 mm	5 1/2 in 140 mm





## Rongeurs (Synovectomy)

### Kleinert-Kutz Synovectomy Rongeur

Single Action

CODE	DESCRIPTION	JAW WIDTH	LENGTH
30-7613	Slightly Curved	2 mm	5½ in 140 mm
30-7614	Fully Curved	2 mm	5½ in 140 mm

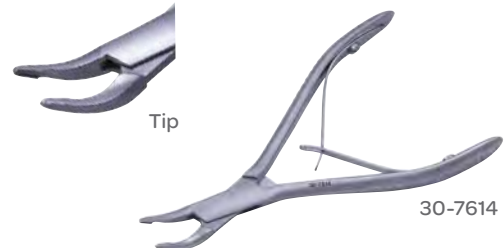

### Kleinert-Kutz Synovectomy Rongeur

Double Action

CODE	DESCRIPTION	JAW WIDTH	LENGTH
31-0552	Slightly Curved	2x13 mm	6 in 150 mm
31-0553	Slightly Curved	3x16mm	6 in 150 mm
31-0554	Fully Curved	3x8.0mm	6 in 150 mm

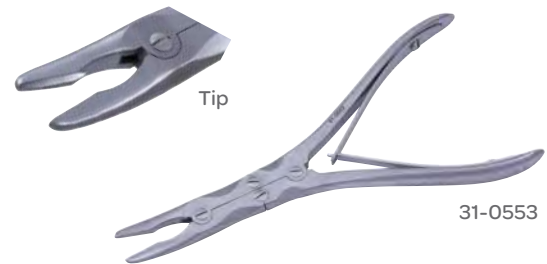

### Beyer Rongeur

Double Action

CODE	DESCRIPTION	JAW WIDTH	LENGTH
31-1003	Curved	3 mm	7⅛ in 180 mm
31-1104	Curved	4 mm	7⅛ in 180 mm



### Blumenthal Rongeur

CODE	DESCRIPTION	JAW WIDTH	LENGTH
30-2547	30° Angle	4 mm	6¼ in 160 mm
30-2545	45° Angle	4 mm	6¼ in 160 mm
30-2546	90° Angle	4 mm	6¼ in 160 mm



## Rongeurs (Synovectomy)

### Citelli Rongeur

Serrated Bite

CODE	DESCRIPTION	BITE	LENGTH
62-6251	9.5 mm Shaft	#1, 1.5 x 4 mm	5½ in 140 mm
62-6252	8.5 mm Shaft	#2, 2.5 x 4 mm	5½ in 140 mm



62-6252

### Goldman-Kazanjian Rongeur

CODE	DESCRIPTION	JAW WIDTH	LENGTH
30-8000	Straight Handle	17 mm	7 in 175 mm



### Jansen Rongeur

CODE	DESCRIPTION	JAW WIDTH	LENGTH
30-7959	Bayonet Shaped	4 mm	6¾ in 170 mm



### Juers-Lempert Rongeur

Jaws on Curved Handles

CODE	HANDLE	JAW WIDTH	LENGTH
30-7621	Straight	3 mm Wide	7½ in 190 mm

## Rongeurs (Synovectomy)

### Leksell Rongeur

Double Action

CODE	DESCRIPTION	JAW WIDTH	LENGTH
31-5103	Lightly Curve	3 mm	9 in 228 mm
31-5105	Lightly Curve	5 mm	9 in 228 mm
31-5108	Lightly Curve	8 mm	9 in 228 mm
31-5303	Fully Curved	3 mm	9 in 228 mm
31-5305	Fully Curved	5 mm	9 in 228 mm
31-5308	Fully Curved	8 mm	9 in 228 mm



### Lempert Rongeur

2.5 mm Jaws

CODE	DESCRIPTION	HANDLE	LENGTH
30-7620	Straight	Slender Pattern	6¼ in 160 mm
30-7624	Straight	Slender Pattern	7½ in 190 mm
30-7619	Straight	Heavy Pattern	7½ in 190 mm
30-7623	Curved	Slender Pattern	7¼ in 185 mm
30-7625	Curved	Slender Pattern	7½ in 190 mm
30-7622	Strong Curved	Slender Pattern	6¼ in 160 mm

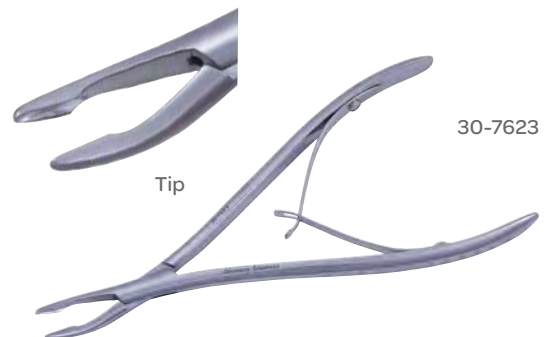

### Zaufel-Jansen Rongeur

Double Action

CODE	DESCRIPTION	WIDTH	LENGTH
31-1105	Curved	5 mm	7⅛ in 180 mm



## Saws (Nasal)

### Joseph Bayonet Saw

CODE	DESCRIPTION	LENGTH
67-6010	Straight	7¼ in 185 mm
67-6011	Angled Left	7¼ in 185 mm
67-6012	Angled Right	7¼ in 185 mm

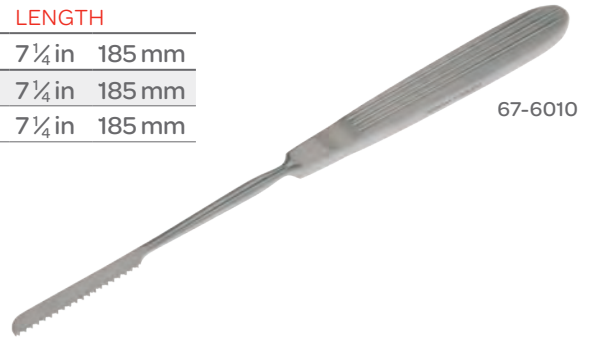

### Maltz-Joseph Saw

CODE	DESCRIPTION	WORKING LENGTH
67-6021	Angled Left	3¼ in 83 mm
67-6022	Angled Right	3¼ in 83 mm



## Scissors (Alligator)

### Bellucci Alligator Scissors

CODE	DESCRIPTION	SHAFT	BLADES	LENGTH
61-0706	Straight	74 mm	5 mm	5¼ in 135 mm
61-0710	Straight	77 mm	7 mm	5¼ in 135 mm
61-0710E	Straight, Ebonized	77 mm	7 mm	5¼ in 135 mm
61-0707	Curved Left	74 mm	5 mm	5¼ in 135 mm
61-0704	Curved Left	75 mm	7 mm	5¼ in 135 mm
61-0708	Curved Right	74 mm	5 mm	5¼ in 135 mm
61-0705	Curved Right	75 mm	7 mm	5¼ in 135 mm
61-0708E	Curved Right, Ebonized	74 mm	5 mm	5¼ in 135 mm



## Scissors (Alligator)

### Luetje Alligator Scissors

90 mm Shaft

CODE	DESCRIPTION	BLADES	LENGTH
61-0712	Straight	4 mm	5 ¼ in 135 mm

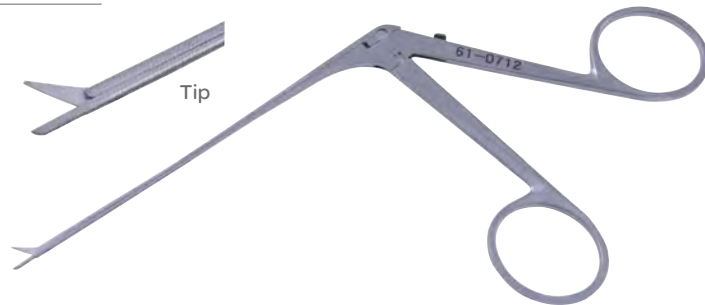

## Scissors (Dissecting)

### Brown Dissecting Scissors

Narrow Blades

CODE	DESCRIPTION	LENGTH
04-5075	Straight	5 ¾ in 145 mm
04-5076	Curved	5 ½ in 140 mm



### Kaye Dissecting Scissors

Serrated

CODE	DESCRIPTION	LENGTH
67-5120	Straight	4 ¾ in 108 mm
67-5121	Curved	4 ¾ in 108 mm



## Scissors (Dorsal)

### Converse Dorsal Scissors

CODE	DESCRIPTION	LENGTH
67-5511	Serrated Blades	6½ in 165 mm



### Cottle Dorsal Scissors

Angled Handle

CODE	DESCRIPTION	LENGTH
67-5316	Heavy Pattern	6 in 150 mm



### Cottle Dorsal Scissors

Angled Handle

CODE	DESCRIPTION	LENGTH
32-583	Tungsten Carbide	6¼ in 160 mm



### Dorsal Scissors

CODE	DESCRIPTION	LENGTH
67-5508	Straight, Blunt	4¾ in 120 mm



## Scissors (Dorsal)

### Fomon Dorsal Scissors

Fine Tungsten Carbide Blade, Serrated Lower Blade

CODE	DESCRIPTION	LENGTH
32-572	Angled Handle	5 <sup>5</sup> / <sub>16</sub> in 137 mm



### Fomon Dorsal Scissors

Serrated Blades

CODE	DESCRIPTION	LENGTH
67-5313	Angled Handle	6 <sup>1</sup> / <sub>2</sub> in 165 mm

### Ceramic Coated Cottle Dorsal Scissors

Razor Edges and Micro Serrations

CODE	DESCRIPTION	LENGTH
227.53.36	Ceramic Coated	6 <sup>1</sup> / <sub>4</sub> in 160 mm



### Converse Double Edge Scissors

CODE	DESCRIPTION	LENGTH
67-5013	Straight	5 <sup>1</sup> / <sub>8</sub> in 130 mm

## Scissors (Face Lift)

### Judy Friedman Face Lift Scissors

Curved, Sharp Outer Edges

CODE	DESCRIPTION	LENGTH
67-5154	Slender Pattern	9 <sup>7</sup> / <sub>8</sub> in 250 mm
67-5155	Heavy Pattern	6 <sup>3</sup> / <sub>4</sub> in 170 mm

## Scissors (Ganglion)

### Adson Kelly Ganglion Scissors

Sharp Outer Edges

CODE	DESCRIPTION	LENGTH
04-5416	Straight	6 <sup>1</sup> / <sub>4</sub> in 160 mm
04-5516	Curved	6 <sup>1</sup> / <sub>4</sub> in 160 mm



04-5516

## Scissors (Iris)

### Knapp Iris Scissors

CODE	DESCRIPTION	LENGTH
54-6524	Straight Sharp/Blunt	4 in 102 mm
54-6526	Straight Blunt/Blunt	4 in 102 mm
54-6525	Curved Sharp/Blunt	4 in 102 mm
54-6527	Curved Blunt/Blunt	4 in 102 mm



54-6524



## Scissors (Lower Lateral)

### Cinelli Lower Lateral Scissors

CODE	DESCRIPTION	LENGTH
67-5211	Strong Curve	4½ in 115 mm



### Fomon Lower Lateral Scissors

CODE	DESCRIPTION	LENGTH
67-5212	Strong Curve	5⅜ in 137 mm



## Scissors (Micro-Laryngeal)

### Jako Micro-Laryngeal Scissors

CODE	DESCRIPTION	LENGTH
74-5932	Straight, Vertical Cut	9¼ in 235 mm
74-5931	Angled Up	9¼ in 235 mm
74-5934	Curved Left, Vertical Cut	9¼ in 235 mm
74-5935	Curved Right, Vertical Cut	9¼ in 235 mm



Tip



74-5934

### Jako-Kleinsasser Micro-Laryngeal Scissors

CODE	DESCRIPTION	LENGTH
74-5974	Straight	8⅝ in 219 mm
74-5977	Angled Left	8⅝ in 219 mm
74-5976	Angled Right	8⅝ in 219 mm
74-5975	Angled Up	8⅝ in 219 mm

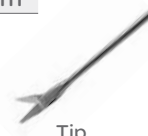

Tip



74-5974

## Scissors (Micro-Laryngeal)

### Kleinsasser Micro-Laryngeal Scissors

CODE	DESCRIPTION	BLADES	LENGTH
74-6028	Straight	4 mm	10 <sup>3</sup> / <sub>4</sub> in 270 mm
74-6035	Straight, Serrated	4 mm	10 <sup>3</sup> / <sub>4</sub> in 270 mm
74-6028	Curved Left	4 mm	10 <sup>3</sup> / <sub>4</sub> in 270 mm
74-6036	Curved Left, Serrated	4 mm	10 <sup>3</sup> / <sub>4</sub> in 270 mm
74-6030	Curved Right	4 mm	10 <sup>3</sup> / <sub>4</sub> in 270 mm
74-6037	Curved Right, Serrated	4 mm	10 <sup>3</sup> / <sub>4</sub> in 270 mm
74-6031	Curved Up	4 mm	10 <sup>3</sup> / <sub>4</sub> in 270 mm
74-6038	Curved Up, Serrated	4 mm	10 <sup>3</sup> / <sub>4</sub> in 270 mm

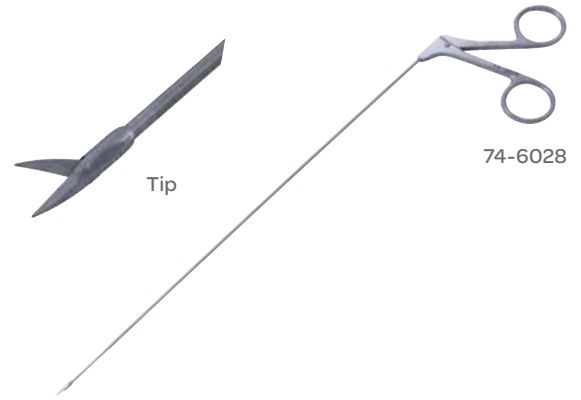

### Shea-Bellucci Scissors

Extra Narrow

CODE	DESCRIPTION	BLADES	LENGTH
61-0709	Straight	8 mm	5 <sup>1</sup> / <sub>4</sub> in 135 mm



## Scissors (Miniature)

### Bellucci Miniature Scissors

CODE	DESCRIPTION	BLADES	SHAFT	LENGTH
61-0713	Straight	4 mm Sharp	75 mm	5 <sup>1</sup> / <sub>4</sub> in 135 mm



## Scissors (Nasal)

### Converse-Wilmer Nasal Scissors

CODE	DESCRIPTION	LENGTH
67-5513	Angled on Flat	4 in 135 mm



### Fomon Nasal Scissors

CODE	DESCRIPTION	LENGTH
67-5112	Curved	5¼ in 125 mm



### Goldman Nasal Scissors

Saber Back, Semi-Sharp Outer-Edges

CODE	DESCRIPTION	LENGTH
67-5506	Curved	5¾ in 145 mm



### Knight Nasal Scissors

CODE	DESCRIPTION	LENGTH
67-5503	Standard Pattern	7 in 175 mm



### Jackson Nasal Bone Scissors

Angled Blade, Serrated

CODE	DESCRIPTION	LENGTH
67-5516	Heavy Pattern	8½ in 215 mm



## Scissors (Nasal)

### Jameson Tenotomy Scissors

CODE	DESCRIPTION	LENGTH
80-6716	Curved	6 $\frac{1}{8}$ in 156 mm



### Joseph Scissors

CODE	DESCRIPTION	LENGTH
80-5015	Straight	5 $\frac{3}{4}$ in 145 mm



## Scissors (Razor Edge)

### Kaye Scissors

Razor Edge

CODE	DESCRIPTION	LENGTH
80-4200	Curved	4 $\frac{1}{2}$ in 115 mm



### Ragnell Scissors

Beveled Dissecting Tips

CODE	DESCRIPTION	LENGTH
80-4905	Curved	5 $\frac{1}{4}$ in 133 mm



## Scissors (Removal, Rhinoplasty, Septum)

### Joseph Rhinoplasty Scissors

CODE	DESCRIPTION	BLADE	LENGTH
04-5015	Straight	Sharp/Sharp	6¼ in 160 mm
04-5016	Straight	Sharp Outer Blade	6¼ in 160 mm
04-5115	Curved	Sharp/Sharp	6¼ in 160 mm
04-5116	Curved	Sharp Outer Blade	6¼ in 160 mm



04-5115

### Becker Septum Scissors

CODE	DESCRIPTION	LENGTH
67-5505	Double Action, Angled Handles, Serrated	7¼ in 185 mm



### Caplan Septum Scissors

CODE	DESCRIPTION	LENGTH
67-5371	Double Action, Serrated	7¾ in 197 mm



## Scissors (Septum, Serrated, Sinus)

### Goldman Septum Scissors

CODE	DESCRIPTION	LENGTH
67-5509	Angled Handle, Serrated	5⅞ in 150 mm



## Scissors (Septum, Serrated, Sinus)

### Joseph Scissors with Micro Serrations

CODE	DESCRIPTION	LENGTH
204.50.15	Straight, Gold Screw	5 ¾ in 145 mm
204.51.15	Curved, Gold Screw	5 ¾ in 145 mm



204.51.15

### Sinus Scissors

Pediatric

CODE	DESCRIPTION	SHAFT	BLADES	LENGTH
63-7700	Straight	90 mm	5 mm	5 ¾ in 145 mm
63-7701	Curved Left	90 mm	5 mm	5 ¾ in 145 mm
63-7702	Curved Right	90 mm	5 mm	5 ¾ in 145 mm



63-7701

### Sinus Scissors

Adult

CODE	DESCRIPTION	SHAFT	BLADES	LENGTH
63-7705	Straight, Serrated	155 mm	11 mm	8 ¾ in 222 mm
63-7706	Curved Left, Serrated	155 mm	11 mm	8 ¾ in 222 mm
63-7707	Curved Right, Serrated	155 mm	11 mm	8 ¾ in 222 mm



Tip



63-7706

## Scissors (Strabismus, Suture Carrying)

### Littler Suture Carrying Scissors

CODE	DESCRIPTION	LENGTH
60-1868	Curved, Cutting Blades with Hole	4 ¾ in 120 mm



## Scissors (Tenotomy)

### Jamison Metzenbaum Tenotomy Scissors

CODE	DESCRIPTION	LENGTH
37-4033	Curved	6 in 152 mm
37-4031	Curved	8 in 203 mm
37-4027	Curved	9 in 229 mm



37-4027

### Razor Edge Scissors with Micro Serrations & Gold Screw

CODE	DESCRIPTION	LENGTH
214.67.12	Curved	4 ¾ in 120 mm
214.67.13	Curved	5 ⅛ in 130 mm
214.67.16	Curved	6 ¼ in 158 mm



214.67.16

### Potts Tenotomy Scissors

CODE	DESCRIPTION	LENGTH
37-4032	Curved	6 in 152 mm



### Stevens Tenotomy Scissors

CODE	DESCRIPTION	LENGTH
54-6520	Straight	4 ⅛ in 105 mm
54-6522	Straight	4 ⅝ in 118 mm
54-6521	Curved	4 ⅛ in 105 mm
54-6523	Curved	4 ⅝ in 118 mm



54-6520

## Scissors (Tissue and Gum, Tonsil)

### Fox Tissue and Gum Scissors

Tungsten Carbide Edges

CODE	DESCRIPTION	LENGTH
32-941	Straight	5 1/8 in 130 mm
32-940	Curved	5 1/8 in 130 mm



32-941

### Boettcher Tonsil Scissors

CODE	DESCRIPTION	BLADE	LENGTH
54-1081	Curved	Double-Edged, Angled on Side	7 1/4 in 184 mm
72-4525	Curved	Double-Edged	7 3/8 in 187 mm



72-4525

### Dean Tonsil Scissors

CODE	DESCRIPTION	BLADE	LENGTH
72-4550	Angled	One Serrated	6 3/4 in 170 mm



### Prince Tonsil Scissors

CODE	DESCRIPTION	BLADE	LENGTH
72-4520	Curved	Slender	7 5/16 in 186 mm





## Scissors (Turbinate)

### Gorney Turbinate Scissors

Serrated

CODE	DESCRIPTION	LENGTH
67-5515	Double Action, 33 mm Jaws	8 in 200 mm

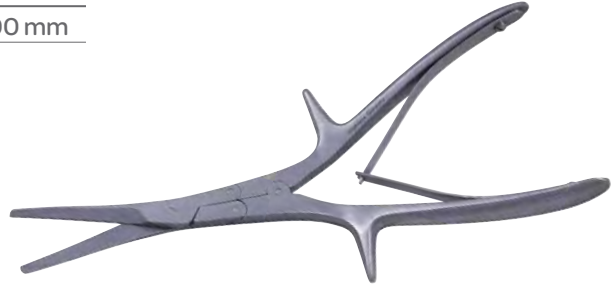

### Seiler Turbinate Scissors

CODE	DESCRIPTION	LENGTH
67-5504	Heavy Pattern, Angled on Side	6¼ in 158 mm



### Brophy Scissors

CODE	DESCRIPTION	LENGTH
04-2014	Straight, Sharp/Sharp	5½ in 140 mm
04-2114	Curved, Sharp/Sharp	5½ in 140 mm

### Jameson Reynolds Scissors

Serrated

CODE	DESCRIPTION	LENGTH
85-2121	Curved	5¼ in 133 mm
85-2123	Curved	6¼ in 158 mm
85-2125	Curved	7 in 177 mm



85-2121

## Scissors

### Jameson Reynolds Scissors

Serrated with Black Handles

CODE	LENGTH
86-6713	5¼ in 133 mm
86-6716	6¼ in 158 mm



86-6716

### Joseph Scissors

Serrated with Black Handles

CODE	DESCRIPTION	LENGTH
86-5015	Straight	6 in 152 mm
86-5115	Curved	6 in 152 mm



86-5115

### Joseph Scissors

Serrated

CODE	DESCRIPTION	LENGTH
85-2063	Straight	6 in 152 mm
85-2064	Curved	6 in 152 mm



85-2064

### Ragnell Dissecting Scissors

Beveled Dissecting Tip

CODE	DESCRIPTION	LENGTH
67-5507	Curved	5 in 127 mm



EAR, NOSE & THROAT

## Snares (Nasal, Snare Wire, Tonsil)

### Bruening Nasal Snare

CODE	DESCRIPTION	LENGTH
66-1510	Complete Bayonet Style W/ Snare & Stylet	8 in 203 mm
66-1512-3	Size 0 0.30 mm	Cut & Formed
66-1512-4	Size 1 0.33 mm	Cut & Formed
66-1512-5	Size 2 0.40 mm	Cut & Formed
66-1512-6	Size 3 0.50 mm	Cut & Formed

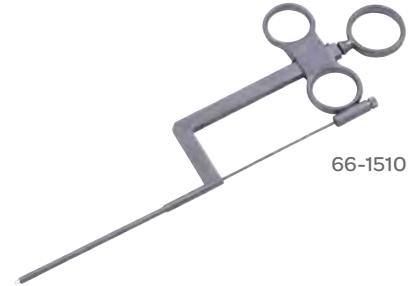

66-1510

### Sage Tonsil Snare

CODE	DESCRIPTION	LENGTH
72-6011	Sage Tonsil Snare Instrument	11 in 280 mm
72-6012-6	0.35 mm	
72-6012-7	0.40 mm	
72-6012-8	0.45 mm	
72-6012-9	0.50 mm	



72-6011

### Tyding Tonsil Snare

CODE	DESCRIPTION	LENGTH
72-5051		9½ in 241 mm
72-6515	Prepared Snare Wire #7	
72-6516	Prepared Snare Wire #8	
72-6517	Prepared Snare Wire #9	



72-5051

## Speculums (Middle Ear, Nasal)

### Shea Ear Speculum Holder

CODE	LENGTH
62-0380	11¾ in 300 mm



### Cottle Nasal Speculum

Self-Retaining, Narrow Tapered Blades

CODE	BLADES	LENGTH
67-0230	30 mm	5½ in 140 mm
67-0235	35 mm	5½ in 140 mm
67-0255	55 mm	5½ in 140 mm
67-0270	70 mm	5½ in 140 mm
67-0275	75 mm	5½ in 140 mm
67-0290	90 mm	5½ in 140 mm



67-0235

## Speculums (Middle Ear, Nasal)

### Halle Nasal Speculum

CODE	BLADE	LENGTH
79-6669	32 mm	6 in 152 mm
63-6235	32 mm	6¼ in 160 mm



79-6669

## Speculums (Nasal)

### Hartmann-Halle Nasal Speculum

CODE	DESCRIPTION	BLADES	LENGTH
66-0301	Small	25 mm	6 in 152 mm
66-0302	Medium	30 mm	6 in 152 mm
66-0303	Large	32 mm	6 in 152 mm



66-0303

### Tieck Infant Nasal Speculum

CODE	BLADES	LENGTH
63-6250	18 mm	5½ in 140 mm



### Vienna Nasal Speculum

CODE	BLADE LENGTH	LENGTH
63-6241	24 mm	5¼ in 133 mm
79-6675	27 mm	5¼ in 133 mm
79-6676	28 mm	5¼ in 133 mm
63-6242	30 mm	5¼ in 133 mm
63-6243	32 mm	5¼ in 133 mm
79-6677	32 mm	5¼ in 133 mm
63-6244	34 mm	5¼ in 133 mm



79-6676

## Speculums (Septum)

### Cottle Septum Speculum

CODE	DESCRIPTION	BLADES	LENGTH
63-6270	Self-Retaining, Thin Modified	50 mm	6 in 152 mm



### Killian Septum Specula & Killian Septum Speculum

Self-Retaining

CODE	BLADES	LENGTH
79-7011	51 mm	5 ¼ in 133 mm
79-7012	63 mm	5 ¼ in 133 mm
79-7013	76 mm	5 ¼ in 133 mm
63-6265	51 mm	6 in 152 mm
63-6266	64 mm	6 in 152 mm
63-6267	76 mm	6 in 152 mm
63-6268	90 mm	6 in 152 mm



79-7011

### Septum Speculum

Self-Retaining, Very Narrow Blade, Ebony Finish

CODE	BLADES	LENGTH
63-2181	35 mm	5 ½ in 139 mm
63-2182	50 mm	5 ½ in 139 mm
63-2183	75 mm	5 ½ in 139 mm
63-2184	90 mm	5 ½ in 139 mm



63-2181

### Tebbetts Speculum

CODE	DESCRIPTION	LENGTH
67-0242	Thin Blades 1 ¾ in (45 mm)	6 in 152 mm



## Speculums (Septum)



61-0932

### Farrior Speculum

CODE	SIZE	DISCRIPTION	DISTAL END
61-0980		Oval Oblique	3 x 4 mm
61-0831		Oval Oblique	3.5 x 4.8 mm
61-0982		Oval Oblique	4 x 5 mm
61-0833		Oval Oblique	4.5 x 5.3 mm
61-0931.5		Oval Oblique	4.5 x 5.5 mm
61-0834		Oval Oblique	5 x 5.8 mm
61-0931	#1	Oval Oblique	5 x 6 mm
61-0835		Oval Oblique	5.5 x 6.3 mm
61-0932.5		Oval Oblique	5.5 x 6.5 mm
61-0836		Oval Oblique	6 x 6.5 mm
61-0932	#2	Oval Oblique	6 x 7 mm
61-0933.5		Oval Oblique	6.5 x 7.5 mm
61-0933	#3	Oval Oblique	7 x 8 mm
61-0934.5		Oval Oblique	7.5 x 8.5 mm
61-0934	#4	Oval Oblique	8 x 9 mm
61-0935	#5	Oval Oblique	9 x 11 mm
61-0936	#6	Oval Oblique	10 x 12 mm
61-0937	#7	Oval Oblique	11 x 13 mm
61-0980E		Ebonized Oval Oblique	3 x 4 mm
61-0831E		Ebonized Oval Oblique	3.5 x 4.8 mm
61-0982E		Ebonized Oval Oblique	4 x 5 mm
61-0833E		Ebonized Oval Oblique	4.5 x 5.3 mm
61-0931.5E		Ebonized Oval Oblique	4.5 x 5.5 mm
61-0834E		Ebonized Oval Oblique	5 x 5.8 mm
61-0931E	#1	Ebonized Oval Oblique	5 x 6 mm
61-0835E		Ebonized Oval Oblique	5.5 x 6.3 mm
61-0932.5E	#2	Ebonized Oval Oblique	5.5 x 6.5 mm
61-0836E		Ebonized Oval Oblique	6 x 6.5 mm
61-0932E		Ebonized Oval Oblique	6 x 7 mm
61-0933.5E		Ebonized Oval Oblique	6.5 x 7.5 mm
61-0933E	#3	Ebonized Oval Oblique	7 x 8 mm
61-0934.5E		Ebonized Oval Oblique	7.5 x 8.5 mm
61-0934E	#4	Ebonized Oval Oblique	8 x 9 mm
61-0935E	#5	Ebonized Oval Oblique	9 x 11 mm
61-0936E	#6	Ebonized Oval Oblique	10 x 12 mm
61-0937E	#7	Ebonized Oval Oblique	11 x 13 mm

## Speculums (Septum)



61-0932

### Farrior Speculum

CODE	SIZE	DESCRIPTION	DISTAL END
61-0917	#1	Oval Regular End	4.5 x 6 mm
61-0918	#2	Oval Regular End	5.5 x 7 mm
61-0919	#3	Oval Regular End	6.5 x 8 mm
61-0920	#4	Oval Regular End	7.5 x 9 mm
61-0921	#5	Oval Regular End	8 x 10 mm
61-0922	#6	Oval Regular End	9 x 11.25 mm
61-0923	#7	Oval Regular End	10 x 12.5 mm
61-0917E	#1	Ebonized Oval Regular End	4.5 x 6 mm
61-0918E	#2	Ebonized Oval Regular End	5.5 x 7 mm
61-0919E	#3	Ebonized Oval Regular End	6.5 x 8 mm
61-0920E	#4	Ebonized Oval Regular End	7.5 x 9 mm
61-0921E	#5	Ebonized Oval Regular End	8 x 10 mm
61-0922E	#6	Ebonized Oval Regular End	9 x 11.25 mm
61-0923E	#7	Ebonized Oval Regular End	10 x 12.5 mm



61-0910

### Farrior Speculum

CODE	SIZE	DESCRIPTION	DISTAL END
61-0910	#1	Round Regular End	5 mm
61-0911	#2	Round Regular End	6 mm
61-0912	#3	Round Regular End	7 mm
61-0913	#4	Round Regular End	8 mm
61-0914	#5	Round Regular End	9 mm
61-0915	#6	Round Regular End	10 mm
61-0916	#4	Round Regular End	10.5 mm
61-0910E	#1	Ebonized, Round Regular End	5 mm
61-0911E	#2	Ebonized, Round Regular End	6 mm
61-0912E	#3	Ebonized, Round Regular End	7 mm
61-0913E	#4	Ebonized, Round Regular End	8 mm
61-0914E	#5	Ebonized, Round Regular End	9 mm
61-0915E	#6	Ebonized, Round Regular End	10 mm
61-0916E	#4	Ebonized, Round Regular End	10.5 mm

## Speculums (Septum)

### Farrior Speculum

CODE	SIZE	DESCRIPTION	DISTAL END
61-0924	#1	Round Oblique End	6 mm
61-0925	#2	Round Oblique End	7 mm
61-0926	#3	Round Oblique End	8 mm
61-0927	#4	Round Oblique End	9 mm
61-0928	#5	Round Oblique End	10 mm
61-0929	#6	Round Oblique End	11 mm
61-0930	#7	Round Oblique End	12 mm
61-0924E	#1	Ebonized Round Oblique End	6 mm
61-0925E	#2	Ebonized Round Oblique End	7 mm
61-0926E	#3	Ebonized Round Oblique End	8 mm
61-0927E	#4	Ebonized Round Oblique End	9 mm
61-0928E	#5	Ebonized Round Oblique End	10 mm
61-0929E	#6	Ebonized Round Oblique End	11 mm
61-0930E	#7	Ebonized Round Oblique End	12 mm



61-0924E

### Boucheron Speculum

Round, Chrome Plated

CODE	SIZE	DISTAL END
61-0901	#1	3 mm
61-0902	#2	4 mm
61-0903	#3	4.5 mm
61-0904	#4	5 mm
61-0906	#5	5.5 mm
61-0907	#6	7 mm
61-0908	#7	8.0 mm
61-0909	#8	9.5 mm



61-0901

### Gruber Speculum

Round, Chrome Plated

CODE	DISTAL END	LENGTH
61-0979	3 mm	33 mm
61-0965	3.5 mm	35 mm
61-0966	4 mm	35 mm
61-0967	5 mm	37 mm



61-0979



## Speculums (Ear)

### Gruber Speculum

Oval, Chrome-Plated

CODE	DISTAL END	LENGTH
61-0975	2 x 3 mm	33 mm
61-0968	3 x 4 mm	33 mm
61-0973	3 x 5 mm	35 mm
61-0974	3 x 6 mm	37 mm
61-0969	5 x 6 mm	42 mm
61-0970	6 x 7 mm	42 mm
61-0971	7 x 8 mm	42 mm



61-0973

### Hartmann Speculum

Round, Chrome-Plated

CODE	DISTAL END	LENGTH
61-0962	2.5 mm	35 mm
61-0953	4 mm	35 mm
61-0954	5 mm	35 mm
61-0955	6 mm	35 mm
61-0956	7 mm	35 mm



61-0955

### Hartmann Speculum

Oval, Chrome-Plated

CODE	DISTAL END	LENGTH
61-0963	2.5 x 3 mm	35 mm
61-0958	4.5 x 5 mm	35 mm
61-0959	5.5 x 6 mm	35 mm
61-0960	6.5 x 7 mm	35 mm
61-0961	7.5 x 8 mm	35 mm



61-0958

### Toynbee Speculum

Round, Chrome Plated

CODE	DISTAL END	LENGTH
61-0950	2 mm End	35 mm
61-0941	4 mm End	35 mm
61-0942	5 mm End	35 mm
61-0943	6 mm End	35 mm
61-0944	7 mm End	35 mm



61-0942

## Speculums (Ear)

### Toybee Speculum

Oval, Chrome Plated

CODE	DISTAL END	LENGTH
61-0939	2.5 x 3.5 mm	35 mm
61-0946	4.5 x 5 mm	35 mm
61-0947	5.5 x 6 mm	35 mm
61-0948	6.5 x 7 mm	35 mm
61-0949	7.5 x 8 mm	35 mm



61-0949

## Spreaders (Middle Ear)

### Guilford-Wright Loop Spreader

CODE	JAWS	SHAFT
61-0137	Pointed Serrated 7.0 mm	75 mm



Tip

## Suction Tubes (Ear, Middle Ear)

### Bellucci Ear Suction Tube

CODE	DESCRIPTION	TIP LENGTH	LENGTH
61-1010	18 Gauge Tip	1 3/8 in 35 mm	6 in 152 mm
61-1011	20 Gauge Tip	1 3/8 in 35 mm	6 in 152 mm
61-1012	21 Gauge Tip	1 3/8 in 35 mm	6 in 152 mm
61-1013	22 Gauge Tip	1 3/8 in 35 mm	6 in 152 mm
61-1014	24 Gauge Tip	1 3/8 in 35 mm	6 in 152 mm
61-1015	26 Gauge Tip	1 3/8 in 35 mm	6 in 152 mm
61-1016	Bellucci Tube Only		6 in 152 mm



61-1014

## Suction Tubes (Ear, Middle Ear)

### Rosen Suction Tube

CODE	DESCRIPTION	LENGTH	
61-1034	14 Gauge	2 in	50 mm
61-1035	15 Gauge	2 in	50 mm
61-1036	16 Gauge	2 in	50 mm
61-1037	17 Gauge	2 in	50 mm
61-1038	18 Gauge	2 in	50 mm
61-1039	19 Gauge	2 in	50 mm
61-1040	20 Gauge	2 in	50 mm
61-1041	22 Gauge	2 in	50 mm
61-1042	24 Gauge	2 in	50 mm
61-1043	26 Gauge	2 in	50 mm



61-1034

### House Cut-Off Adapter

CODE	DESCRIPTION	LENGTH
61-1045	For Use with Rosen Suction	2 in 50 mm



## Suction Tubes (Aspirating)

### Jackson "Velvet Eye" Aspirating Tube

CODE	DESCRIPTION	DIAMETER	LENGTH
72-6046	12 French	4 mm	10 x 250 mm
74-6455	12 French	4 mm	20 x 500 mm
74-6457	"Velvet Eye"		40 x 600 mm

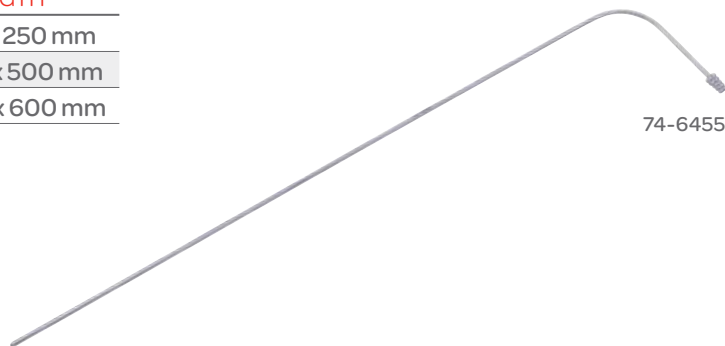

74-6455

## Suction Tubes (Aspirating)

### Jako Suction Tube

CODE	DESCRIPTION	HANDLE	LENGTH
74-5005	#00	5 French	9 in 230 mm
74-5006	#0	6 French	9 in 230 mm
74-5007	#1	7 French	9 in 230 mm



## Suction Tubes (Laryngeal, Septum)

### Kleinsasser Laryngeal Suction Tube

CODE	DESCRIPTION	LENGTH
74-5002	2.5 mm	9 in 230 mm



### Gorney Septum Suction Tube

CODE	DESCRIPTION	LENGTH
63-7570	2 mm, with Stylet	8½ in 215 mm



## Syringes (Ear)

### Ear Syringe

CODE	DESCRIPTION
61-2001	Bulbous Tip
61-2005	Bulbous Tip
61-2006	Shield Tip
61-2004	Tapered Tip



## Tracheal Tubes (Laryngectomy)

### Martin Laryngectomy Tube

CODE	DESCRIPTION
72-6053	Size 8, Stainless Steel
72-6054	Size 10, Stainless Steel
72-6055	Size 12, Stainless Steel



## Trocars (Sinus & Nasal)

### Van Alyea Antrum Trocar

CODE	DESCRIPTION
66-6047	Trocar Tip

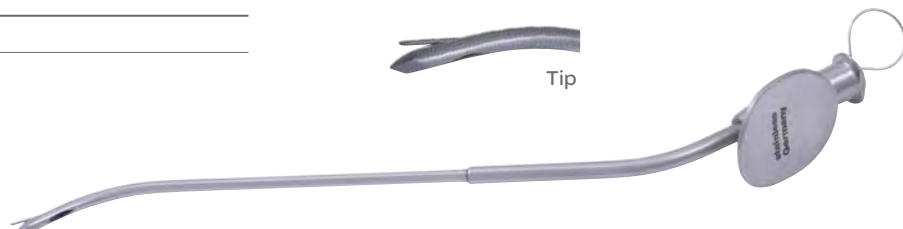

## Tuning Forks (Sinus & Nasal)

### Tuning Fork

Aluminum Alloy for Both Air and Bone Conduction

CODE	DESCRIPTION
62-0709	C-64 with Weights
62-0710	C-128 with Weights
62-0711	C-256 with Weights
62-0712	C-512 without Weights
62-0713	C-1024 without Weights
62-0714	C-2048 without Weights
62-0715	C-4096 without Weights



## Wire Guides (Middle Ear)

### House Wire Strut Guide

CODE	DESCRIPTION	LENGTH
61-0364	Straight Shaft, 0.6 mm Tip with Notched End	6 ½ in 165 mm

