



Scan the code above  
to learn more about  
our General portfolio.

# General Portfolio



symmetry surgical™

# General



Applicators	GEN-2	Needles	GEN-172
Cannulas	GEN-3	Pin Wheels	GEN-173
Clamps	GEN-3	Pliers	GEN-173
Connectors	GEN-17	Probes	GEN-175
Curettes	GEN-18	Punches	GEN-176
Depressors	GEN-19	Raspatories	GEN-177
Dilators	GEN-19	Retractors	GEN-177
Dissectors	GEN-21	Rings	GEN-251
Elevators	GEN-21	Ring Cutters	GEN-251
Extractors	GEN-26	Rulers	GEN-252
Forceps	GEN-26	Scissors	GEN-252
Gonimoters	GEN-123	Scoops	GEN-308
Hammers	GEN-124	Spatulas	GEN-309
Hooks	GEN-124	Sponges	GEN-310
Knives	GEN-131	Stringers	GEN-310
Knife Handles	GEN-131	Suction Tubes	GEN-314
Markers	GEN-135	Trocars	GEN-328
Nail Nippers	GEN-135	Wire & Pin Cutters	GEN-328
Nail Splitters	GEN-138	Wire Twisters	GEN-329
Needle Holders	GEN-138		

Questions? Contact us at [customerservice@symmetrysurgical.com](mailto:customerservice@symmetrysurgical.com) or learn more at [symmetrysurgical.com](http://symmetrysurgical.com)



# The Surgical Instrument Desk Reference

---

## How to Use Our Catalog

---

The Symmetry Surgical catalog is designed with you in mind, to be your trusted resource for surgical instrumentation. We took great care in creating an easy-to-use, robust catalog and we think you'll be pleased with the design as you become more familiar with our broad portfolio.

## Layout

---

The catalog is organized by surgical specialty *and* product function.

And we know that it is difficult to pick up an instrument and know what specialty it's listed in. To make your job easier, we've sorted the instruments in our portfolio by surgical function, too, including Energy, Laparoscopic, Retractors and Sterilization Solutions.

## U.S. Customer Service

---

Your Symmetry Surgical Customer Service team wants to make ordering surgical instruments the easiest part of your day. We accept orders via phone, fax, email, our website, Global Healthcare Exchange (GHX) and through the mail.

### PHONE

800.251.3000

(Available Monday through Friday, 8:30 AM–6:30 PM EST)

### FAX

800.342.3272

### EMAIL

[customerservice@symmetrysurgical.com](mailto:customerservice@symmetrysurgical.com)

### ONLINE

[symmetrysurgical.com](http://symmetrysurgical.com)

### MAILING ADDRESS

Symmetry Surgical  
Attn: Customer Service  
3034 Owen Drive  
Antioch, TN 37013

# The Surgical Instrument Desk Reference

## International Customer Service

### PHONE

Symmetry Surgical Switzerland GmbH  
+41 (0) 52 557 59 00  
(Available Monday through Friday, 7:00-16:00 GMT)

Symmetry Surgical, Inc., USA  
615.964.5672  
(Available Monday through Friday, 8:30 AM–6:30 PM EST)

### FAX

Symmetry Surgical Switzerland GmbH  
+41 (0) 52 557 59 99

### EMAIL

customerservice@symmetrysurgical.com  
internationalorders@symmetrysurgical.com

### ONLINE

symmetrysurgical.com

### MAILING ADDRESS

Symmetry Surgical Switzerland GmbH  
Bühlstrasse 27  
CH-8200 Schaffhausen  
Switzerland

Symmetry Surgical, Inc.  
3034 Owen Drive  
Antioch, TN 37013

### INTERNATIONAL PAYMENT TERMS/RETURN GOODS POLICY/INSTRUMENT REPAIR & RESTORE PROGRAM/LITERATURE REQUESTS

Please contact your local distributor. Locate a local distributor contact, International Customer Service at +41 (0) 52 557 59 00 or 615.964.5672 (US).

Cardiovascular/Thoracic

Energy

Ear, Nose & Throat

General

Laparoscopic

Neurology

Obesity

OB/GYN

Ophthalmology

Orthopedics & Arthroscopy

Pediatrics

Rectal

Retractors

Spine

Urology

Sterilization Solutions

Alphabetical & Numeric Indexes



## Applicators (Cotton)

### Dean Cotton Applicator

CODE	DESCRIPTION	LENGTH
09-2485	Triangular End	6 in 152 mm

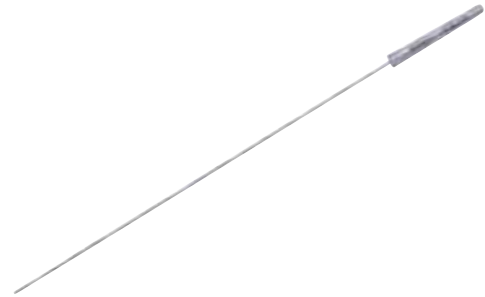

### Farrell Cotton Applicator

CODE	DESCRIPTION	LENGTH
09-2116	Serrated End	6 ¼ in 159 mm
09-2118	Serrated End	7 in 178 mm



09-2116

### Farrell Cotton Applicator

CODE	DESCRIPTION	LENGTH
09-2166	Triangular End	6 ¼ in 159 mm



### Uebe Cotton Applicator

CODE	DESCRIPTION	LENGTH
09-2168	Triangular End	7 in 178 mm



## Cannulas

### Suction/Irrigating Cannula

CODE	DESCRIPTION
57-3953	3.0 x 2.0 mm



## Cannulas

### Heparin I.M.A. Cannula

CODE	TIP WIDTH
54-5998	1.5 mm

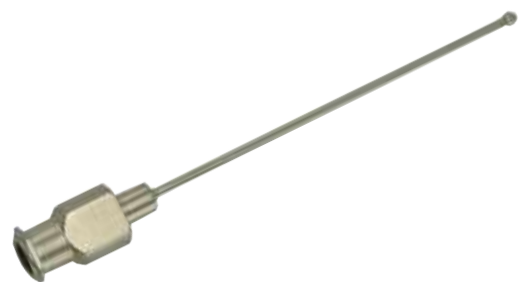

## Clamps (Angiotribe)

### Ferguson Clamp

CODE	DESCRIPTION	LENGTH
16-3816	Straight	6¼ in 159 mm
16-3819	Straight	8 in 203 mm
16-3916	Curved	6½ in 165 mm



16-3816

## Clamps (Cystic Duct)

### Borge Cystic Duct Clamp

CODE	DESCRIPTION	LENGTH
51-3004	4 French	8¼ in 210 mm
51-3006	6 French	8¼ in 210 mm



51-3006

## Clamps (Intestinal)

### Allen Intestinal

CODE	DESCRIPTION	LENGTH
50-1036	Straight, 1x2 Teeth	8 in 203 mm



### Block Potts Intestinal Clamp

CODE	DESCRIPTION	LENGTH
50-1780	Angled 40°	8½ in 216 mm



## Clamps (Suction Tube)

### Lore Suction Holding Clamp

CODE	DESCRIPTION	LENGTH
30-1280	Clamp	7 in 178 mm



## Clamps (Tissue)

### Pennington Clamp

Triangular Jaws

CODE	TIP WIDTH	LENGTH
19-4000	$\frac{7}{16}$ in 11 mm	6 in 152 mm
19-4001	$\frac{7}{16}$ in 11 mm	8 in 203 mm

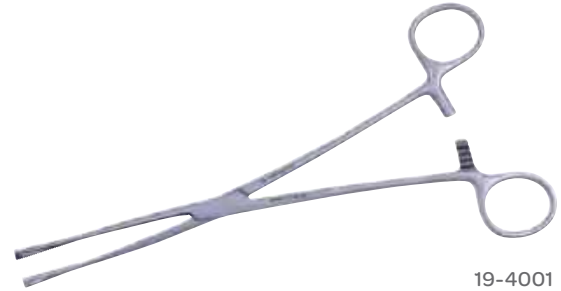

19-4001

## Clamps (Biopsy Clamp)

### Muscle Biopsy Forceps

CODE	JAW WIDTH	LENGTH
06-9100	15 mm	4½ in 114 mm



## Clamps (Breast)

### Adair Breast Clamp

CODE	DESCRIPTION	LENGTH
19-4004	Breast Clamp	7¾ in 197 mm



## Clamps (Gastrointestinal)

### Glassman Non-Crushing Gastrointestinal Clamp

CODE	DESCRIPTION	LENGTH
37-4018	Straight	9¼ in 235 mm
37-4017	Angled	9 in 229 mm



37-4017

## Clamps (Hemostatic)

### Classic® Delicate Clamp

CODE	DESCRIPTION	LENGTH
30-4493	Right Angle	5½ in 140 mm
30-4494	Right Angle	7 in 178 mm



30-4493

### Gemini Classic® Delicate Clamp

CODE	DESCRIPTION	LENGTH
19-5579	Curved	5½ in 140 mm



## Clamps (Hemostatic)

### Gemini Hemostatic Clamp

CODE	DESCRIPTION	LENGTH	
19-5580	Curved	7 in	178 mm
19-5581	Curved	8 in	203 mm
19-5582	Curved	9 in	229 mm



19-5580

### Mixer Right Angle Clamp

Longitudinal Serrations

CODE	DESCRIPTION	LENGTH	
19-8146	Angular, Cross-Serrated Tips	11 in	279 mm

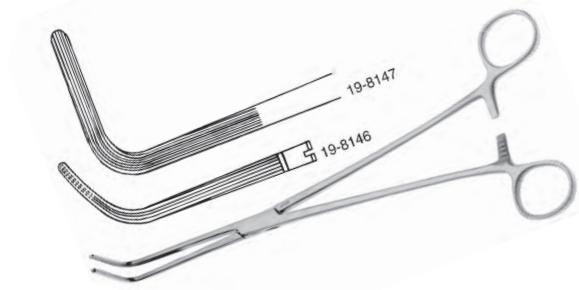

### Vanderbilt Clamp

CODE	DESCRIPTION	LENGTH	
54-5001	Curved	8 $\frac{5}{8}$ in	219 mm
30-3018	Curved	8 $\frac{1}{2}$ in	216 mm



54-5001

## Clamps (Hysterectomy)

### Masterson Hysterectomy Forceps

2 x 3 Vascular Teeth, Jaw Length 1  $\frac{5}{8}$  in (41 mm)

CODE	DESCRIPTION	LENGTH	
37-1520	Straight	8 $\frac{1}{2}$ in	216 mm
37-1521	Curved	8 $\frac{1}{2}$ in	216 mm

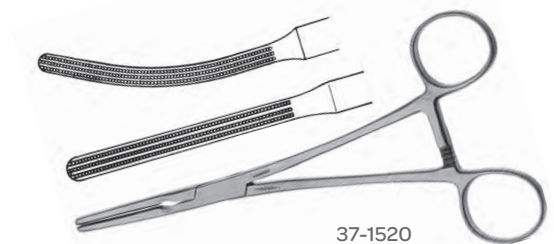

37-1520

## Clamps (Hysterectomy)

### Masterson Pelvic Clamp

Jaw Length  $1\frac{3}{4}$  in (44 mm)

CODE	DESCRIPTION	LENGTH
37-1522	Straight	$10\frac{1}{2}$ in 267 mm
37-1523	Curved	$10\frac{1}{2}$ in 267 mm

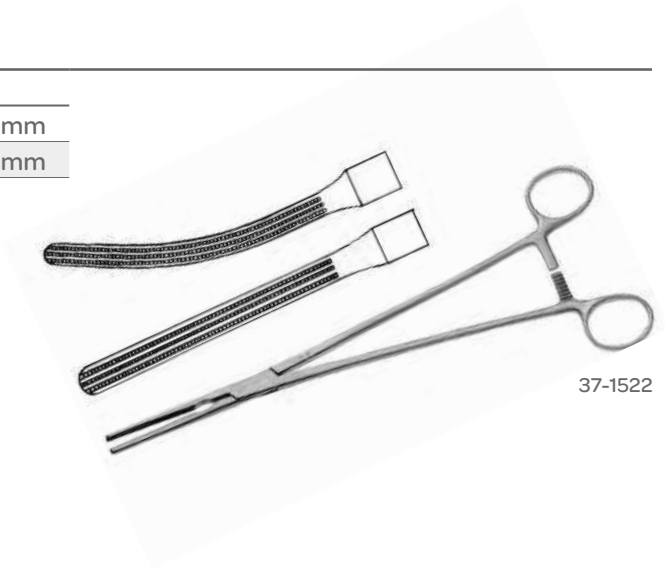

37-1522

### Rogers Hysterectomy Forceps

Sarot-Style Shanks, 2 x 3 Vascular Teeth

CODE	DESCRIPTION	JAW LENGTH	LENGTH
37-1502	Straight	$1\frac{3}{4}$ in 44 mm	10 in 254 mm
37-1503	Curved	$1\frac{3}{4}$ in 44 mm	10 in 254 mm



37-1502  
Tip

### Rogers Hysterectomy Forceps

2 x 3 Vascular Teeth, Sarot Style Shanks

CODE	DESCRIPTION	JAW LENGTH	LENGTH
37-1501	Straight	$1\frac{1}{2}$ in 38 mm	$8\frac{1}{2}$ in 216 mm
37-1502	Straight	$1\frac{3}{4}$ in 44 mm	10 in 254 mm
37-1500	Curved	$1\frac{1}{2}$ in 38 mm	$8\frac{1}{2}$ in 216 mm
37-1503	Curved	$1\frac{3}{4}$ in 44 mm	10 in 254 mm



37-1500



## Clamps (Intestinal)

### Dennis Intestinal Clamp

CODE	JAW LENGTH	LENGTH
19-4060	2¼ in 57 mm	9½ in 241 mm



### Doyen Vascular Toothed Intestinal Clamp

2x3 Vascular Teeth

CODE	DESCRIPTION	JAW LENGTH	LENGTH
37-1600	Straight	3¾ in 95 mm	9 in 229 mm
37-1601	Curved	3¾ in 95 mm	9 in 229 mm



37-1600

### Masters Intestinal Clamp

CODE	JAW LENGTH	LENGTH
19-4062	4½ in 114 mm	9¼ in 235 mm
19-4061	6½ in 165 mm	10¾ in 270 mm



19-4062

## Clamps (Kidney)

### Herrick Kidney Clamp

CODE	DESCRIPTION	LENGTH
51-5735	Double-Angled Jaws with Longitudinal Serrations	9 in 229 mm



## Clamps (Kidney)

### Mayo-Guyon Kidney Clamp

CODE	JAW LENGTH	LENGTH
19-4018	3 $\frac{1}{16}$ in 85 mm	9 in 229 mm



### Renal Artery Clamp

2 x 2 Vascular Teeth, Curved Shafts, Blades Calibrated at 5.0 mm Intervals

CODE	JAW LENGTH	LENGTH
37-1242	1 in 25 mm	10 $\frac{5}{8}$ in 270 mm



### Wertheim-Cullen Kidney Clamp

CODE	DESCRIPTION	LENGTH
51-5775	Right-Angled Jaws with Longitudinal Serrations	8 $\frac{1}{2}$ in 216 mm



## Clamps (Liver)

### Masters-Schwartz Liver Clamp

CODE	JAW WIDTH	JAW LENGTH	LENGTH
19-4063	$\frac{1}{2}$ in 13 mm	7 $\frac{1}{2}$ in 191 mm	12 in 305 mm

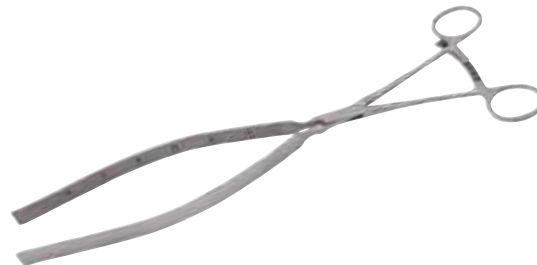

## Clamps (Pile)

### Buie Pile Clamp

CODE	JAW LENGTH	LENGTH
19-5515	2 in 51 mm	8½ in 216 mm



## Clamps (Pylorus)

### Payr Pylorus Clamp

Without Pins

CODE	JAW LENGTH	LENGTH
50-5220	3 in 76 mm	8 in 203 mm
50-5235	5¾ in 146 mm	13¾ in 349 mm



## Clamps (Thoracic)

### Castaneda-Mixter Thoracic Clamp

CODE	DESCRIPTION	LENGTH
19-8150	Smooth Jaws	5¼ in 133 mm



### Collier Modified Thoracic Clamp

CODE	DESCRIPTION	LENGTH
30-8065	Curved	10½ in 267 mm



## Clamps (Thoracic)

### Jones Thoracic Clamp

CODE	DESCRIPTION	LENGTH
19-8152	Curved	11¼ in 286 mm

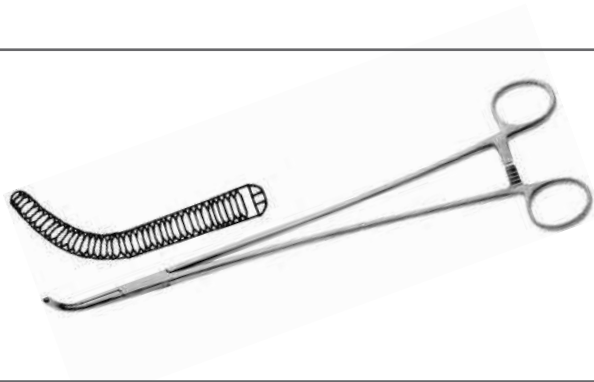

### Mixer Thoracic Clamp

CODE	DESCRIPTION	LENGTH
19-8145	Curved, Cross-Serrations	9 in 229 mm
19-8147	Angular, Longitudinal Serrations, Standard Jaw	11 in 279 mm



19-8145

## Clamps (Towel)

### Backhaus Towel Clamp

CODE	DESCRIPTION	LENGTH
17-5508	Sharp Tips	3½ in 89 mm
17-5510	Sharp Tips	4½ in 114 mm
17-5513	Sharp Tips	5½ in 140 mm
32-5005	Bright Finish	5½ in 140 mm



17-5508

### Edna Classic® Towel Clamp

CODE	DESCRIPTION	LENGTH
33-5016	Non-Perforating	4 in 102 mm
32-5015	Non-Perforating	5½ in 140 mm



33-5016

## Clamps (Towel)

### Jones Towel Clamp

CODE	DESCRIPTION	LENGTH
17-5008	Cross-Action	3½ in 89 mm
19-1016	Cross-Action	3½ in 89 mm



### Lorna (Edna) Towel Clamp

CODE	DESCRIPTION	LENGTH
17-5715	Non-Perforating	4 in 102 mm
17-5714	Non-Perforating	5½ in 140 mm



### Peers Non-Perforating Towel Clip

CODE	DESCRIPTION	LENGTH
17-5800	Non-Perforating Jaws	5¾ in 146 mm
19-4146	Non-Perforating Jaws	5¾ in 146 mm

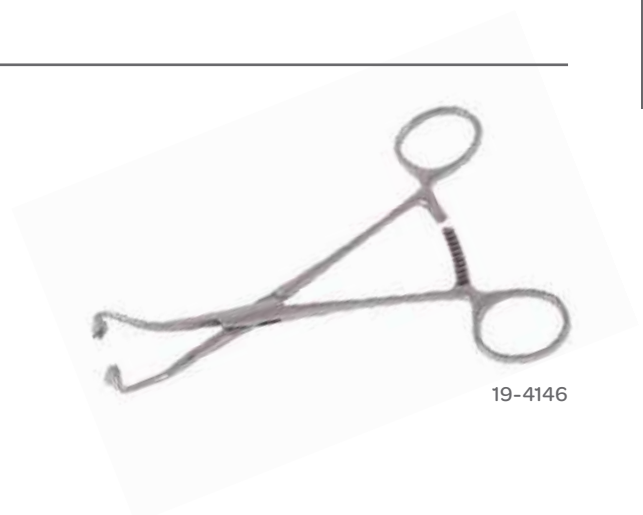

## Clamps (Towel)

### Roeder Towel Clamp

CODE	DESCRIPTION	LENGTH
19-4012	Ball Stops	5¼ in 133 mm



### Towel Clamp

CODE	DESCRIPTION	LENGTH
17-5783	Jaws, Non-Perforating	5⅞ in 130 mm

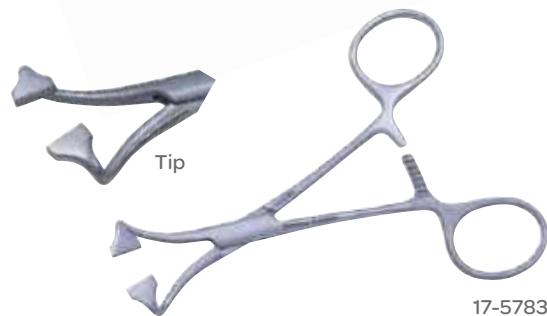

17-5783

### Towel Clamp

CODE	DESCRIPTION	LENGTH
19-4137	Sterile, 6 Clamps to Package, 24 Packages to Case	2¾ in 70 mm
19-4141	Non-Sterile, Bulk Pack of 432	2¾ in 70 mm



## Clamps (Tubing)

### Presbyterian Hospital Tubing Clamp

Heavy Pattern

CODE	DESCRIPTION	LENGTH
17-7216	Smooth Jaws	6½ in 166 mm
17-7218	Smooth Jaws	7 in 178 mm
17-7220	Smooth Jaws	8 in 203 mm



17-7216

## Clamps (Tubing)

### Tubing Clamp

CODE	DESCRIPTION	LENGTH
32-3514	With Guard for Tubing 2.2 cm	8 in 203 mm



### Tubing Clamp

Cross-Hatched Jaws, Tubing Jaw Length 1 in (25 mm), Tubing Jaw Opening with Closed Ratchets,  $\frac{1}{8}$  in (3.0 mm)

CODE	JAW LENGTH	LENGTH
19-4133	1 $\frac{3}{4}$ in 44 mm	6 $\frac{1}{2}$ in 165 mm



### Tubing Clamp

Should be Used with Tubing No Larger than  $\frac{1}{4}$  in (6.0 mm) in Diameter

CODE	JAW LENGTH	LENGTH
19-8010	Length to Cuff 1 $\frac{5}{16}$ in (32 mm)	7 $\frac{1}{2}$ in 191 mm



### U.S. Pattern Tube Occluding Forceps

U-Shaped Guard

CODE	DESCRIPTION	LENGTH
17-7280	Serrated Jaws	6 in 152 mm
17-7281	Serrated Jaws	6 $\frac{3}{4}$ in 171 mm
17-7282	Serrated Heavy Jaws	8 in 203 mm



17-7280



## Clamps (Tubing)

### Vorse Tubing Clamp

CODE	DESCRIPTION	LENGTH	
17-7283	Serrated Beveled Jaws	6 in	152 mm
17-7284	Serrated Beveled Jaws	7½ in	191 mm
17-7285	Serrated Heavy Jaws	8 in	203 mm



17-7285

## Clamps (Vasectomy)

### Vasectomy Fixation Ring Clamp

CODE	DESCRIPTION	LENGTH	
51-8005	15 Gauge Ring	6 in	152 mm



### Vasectomy No Scalpel Hemostat Clamp

CODE	DESCRIPTION	LENGTH	
51-4001	Curved	6 in	152 mm



### Vasectomy Clamp

CODE	DESCRIPTION	LENGTH	
51-8002	5x5 Blunt Teeth, Circular Jaws	6 in	152 mm



## Clamps (Vessel)

### Guyon-Mayo Vessel Clamp

CODE	DESCRIPTION	LENGTH
51-5615	Double-Curved Jaws	9 ¼ in 235 mm



## Clamps (Wire)

### Rubio Classic® Wire Holder Clamp

Tungsten Carbide Jaw Inserts

CODE	JAW WIDTH	LENGTH
36-2023	1.0 mm	5 in 127 mm



## Connectors (Luer-Lock)

### Connector

Luer Lock Connector

CODE	DESCRIPTION
09-7925	Olive End, Male Attachment for 3/16 in (21 mm) Tubing
09-7927	Olive End, Female Attachment for 3/16 in (21 mm) Tubing
09-7932	Cone End, Female Attachment Suitable for Inner 2.0–6.0 mm
09-7935	Cone End, Female Attachment for Inner 5.0–9.0 mm



09-7925

### Stopcock

Luer Lock Connector

CODE	DESCRIPTION
09-7955	One-Way Male/Female
09-7965	Three-Way, 1 Male, 2 Female



09-7955

## Curettes

### Verucca Curette

Without Hole

CODE	TIP WIDTH	LENGTH
43-0483.0	1.0 mm	5 in 127 mm
43-0483.1	1.5 mm	5 in 127 mm
43-0483.2	2.0 mm	5 in 127 mm
43-0483	3.0 mm	5 in 127 mm
43-0485	4.0 mm	5 in 127 mm



43-0483

### Curette Excavator

CODE	DESCRIPTION	LENGTH
43-0459	Non-Fenestrated Cup, 1.0 mm	5 in 127 mm
43-0461	Non-Fenestrated Cup, 1.5 mm	5 in 127 mm
43-0463	Non-Fenestrated Cup, 2.0 mm	5 in 127 mm
43-0465	Non-Fenestrated Cup, 2.5 mm	5 in 127 mm
43-0468	Fenestrated Cup, 1.0 mm	5 in 127 mm
43-0480	Fenestrated Cup, 2.0 mm	5 in 127 mm
43-0481	Fenestrated Cup, 2.5 mm	5 in 127 mm
43-0488	With Hole, 1.5 mm and 2.0 mm	5½ in 140 mm
43-0492	Double-Ended, 1.5 mm and 2.5 mm	5½ in 140 mm



43-0465

### Fox Dermal Curette

Round

CODE	TIP WIDTH	LENGTH
43-1302	2.0 mm	5¾ in 146 mm
43-1303	3.0 mm	5¾ in 146 mm
43-1304	4.0 mm	5¾ in 146 mm
43-1305	5.0 mm	5¾ in 146 mm
43-1306	6.0 mm	5¾ in 146 mm



43-1302

## Depressors

### Wieder Tongue Depressors

Fenestrated-Serrated Blade

CODE	DESCRIPTION	BLADE WIDTH	
83-6505	Small Blade	1 $\frac{3}{16}$ in	30 mm
83-6506	Large Blade	1 $\frac{3}{8}$ in	35 mm



83-6506

### Dilators (Common Bile Duct)



### Bakes Common Duct Dilator Set

Malleable

CODE	DESCRIPTION	LENGTH	
25-4005	Set of Nine in Blue Vinyl Roll		
51-0601	1.0 mm	11 $\frac{3}{4}$ in	298 mm
51-0602	2.0 mm	11 $\frac{3}{4}$ in	298 mm
51-0603	3.0 mm	11 $\frac{3}{4}$ in	298 mm
51-0604	4.0 mm	11 $\frac{3}{4}$ in	298 mm
51-0605	5.0 mm	11 $\frac{3}{4}$ in	298 mm
51-0606	6.0 mm	11 $\frac{3}{4}$ in	298 mm
51-0607	7.0 mm	11 $\frac{3}{4}$ in	298 mm
51-0608	8.0 mm	11 $\frac{3}{4}$ in	298 mm
51-0609	9.0 mm	11 $\frac{3}{4}$ in	298 mm
51-0610	10 mm	11 $\frac{3}{4}$ in	298 mm
51-0611	11 mm	11 $\frac{3}{4}$ in	298 mm
51-0612	12 mm	11 $\frac{3}{4}$ in	298 mm
51-0613	13 mm	11 $\frac{3}{4}$ in	298 mm

## Dilators (Vascular)

### Garrett Vascular Dilators

Malleable Shaft

CODE	DESCRIPTION	LENGTH	
25-8035	Garrett Dilator Set	5½ in	140 mm
25-8036	1.0 mm	5½ in	140 mm
25-8037	1.5 mm	5½ in	140 mm
25-8038	2.0 mm	5½ in	140 mm
25-8039	2.5 mm	5½ in	140 mm
25-8040	3.0 mm	5½ in	140 mm
25-8041	3.5 mm	5½ in	140 mm
25-8042	4.0 mm	5½ in	140 mm
25-8043	4.5 mm	5½ in	140 mm
25-8044	5.0 mm	5½ in	140 mm



## Dilators (Tracheal Dilators)

### LaBorde Tracheal Dilator, Tri-Valve

CODE	DESCRIPTION	LENGTH	
25-4002	Jaw Width $\frac{3}{16}$ in (5.0 mm) Jaw Thickness $\frac{1}{4}$ in (6.0 mm) Total Spread $1\frac{15}{16}$ in (23.8 mm)	5¼ in	133 mm



## Dilator (Tracheal Dilators)

### Trousseau Tracheal Bi-Valve Dilator

CODE	DESCRIPTION	LENGTH	
25-4000	Jaw Width (Closed) $\frac{1}{4}$ in (6.0 mm) Jaw Thickness $\frac{3}{16}$ in (5.0 mm) Total Spread $1\frac{1}{2}$ in (38 mm)	5½ in	140 mm
25-5569	Jaw Width (Closed) $\frac{1}{8}$ in (3.0 mm) Jaw Thickness $\frac{1}{8}$ in (3.0 mm) Total Spread $1\frac{1}{4}$ in (32 mm)	5¼ in	133 mm



## Dissectors

### Cherry Secto® Dissectors

Dispenser box includes 96 packages of 5 each; 4 dispenser boxes to a case.

CODE	DESCRIPTION	DIAMETER
81-1002	Sterile, X-Ray Detectable	$\frac{3}{8}$ in 10 mm

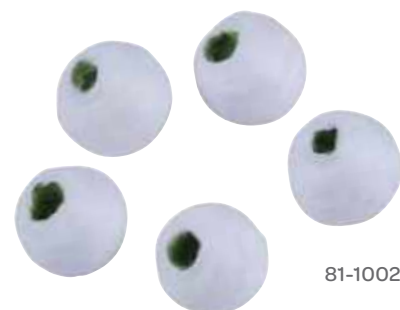

81-1002

### Kittner Secto® Dissectors

Dispenser box includes 96 packages of 5 each; 4 dispenser boxes to a case.

CODE	DESCRIPTION	DIAMETER
81-1001	Sterile, X-Ray Detectable	$\frac{5}{16}$ in 8.0 mm

### Peanut Secto® Dissectors

Dispenser box includes 96 packages of 5 each; 4 dispenser boxes to a case.

CODE	DESCRIPTION	DIAMETER
81-1000	Sterile, X-Ray Detectable	$\frac{3}{8}$ in 10 mm

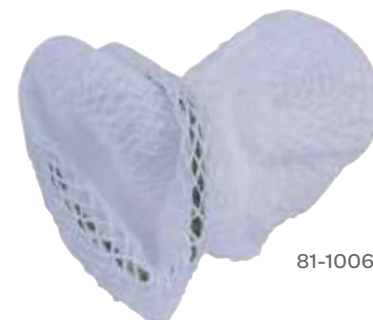

81-1006

### Triangle Secto® Dissectors

Dispenser box includes 96 packages of 5 each; 4 dispenser boxes to a case.

CODE	DESCRIPTION	DIAMETER
81-1006	Sterile, X-Ray Detectable	$\frac{1}{2}$ in 13 mm

## Elevators

### Magnafree® Woodson Elevator & Spatula

CODE	DESCRIPTION	BLADE (W X D)	LENGTH
65-2423	Semi-Sharp, Titanium	$\frac{1}{8}$ x $\frac{1}{2}$ in 3.0 x 13 mm	10 in 254 mm



### Verity™ Elevator

Stainless Steel Shaft, Titanium Handle, Curved Tip

80-1537

CODE	DESCRIPTION	TIP WIDTH	WORKING DISTANCE	LENGTH
80-1537	Straight	3.5 mm		7 $\frac{1}{4}$ in 184 mm
80-1503	Bayonet	3.5 mm	4 in 102 mm	8 in 203 mm



## Elevators

### Rhoton® General Purpose Elevator

Titanium

80-1683



CODE	DESCRIPTION	TIP WIDTH	LENGTH
80-1683	Straight, Blunt, Small	1.2 mm	7½ in 191 mm
80-1684	Curved, Blunt, Large	2.2 mm	7½ in 191 mm

### Woodson-Dural Separator & Packer



CODE	DESCRIPTION	BLADE (W X L)	LENGTH
65-1135	Double-Ended with Groove in Blade	⅛ x ½ in 3.0 x 13 mm	7 in 178 mm

### Adson Periosteal Elevator

65-1033



CODE	DESCRIPTION	BLADE WIDTH	LENGTH
65-1030	#1, Chisel Edge Blade	⅝ in 8.0 mm	6½ in 165 mm
65-1031	#2, Curved, Blunt Edge	¼ in 6.0 mm	6½ in 165 mm
65-1032	#3, Curved, Semi-Sharp Edge	¼ in 6.0 mm	6½ in 165 mm
65-1033	#4, Straight, Semi-Sharp Edge	⅝ in 8.0 mm	6½ in 165 mm

### Carroll Periosteal Elevator



CODE	DESCRIPTION	BLADE WIDTHS	LENGTH
65-2549	Double-Ended	⅛ in, ⅜ in 3.0 mm, 10 mm	5½ in 140 mm

### Cushing Little Joker Periosteal Elevator

65-1047



CODE	DESCRIPTION	BLADE WIDTH	LENGTH
65-1047	"Little Joker" Hollow Handle	¼ in 6.0 mm	6 in 152 mm
65-1048	"Little Joker" Solid Handle	¼ in 6.0 mm	7½ in 191 mm



## Elevators

## Cushing Periosteal Elevator



65-1075

Sharp

CODE	DESCRIPTION	BLADE WIDTH	LENGTH
65-1050	Narrow, Round Handle	$\frac{1}{4}$ in 6.0 mm	$8\frac{1}{8}$ in 206 mm
65-1075	Wide, Rounded Edge Blade	$\frac{5}{8}$ in 16 mm	$7\frac{1}{4}$ in 184 mm
65-1076	Wide, Square Edge Blade	$\frac{5}{8}$ in 16 mm	$7\frac{1}{4}$ in 184 mm



## Cushing Staphylorrhaphy Elevator

CODE	DESCRIPTION	BLADE WIDTH	LENGTH
65-1045	Round Handle	$\frac{7}{16}$ in 11 mm	$8\frac{1}{2}$ in 216 mm



## Dorsey Dural Separator

CODE	BLADE WIDTH	BLADE LENGTH	LENGTH
65-1104	$\frac{3}{16}$ in 5.0 mm	$1\frac{1}{16}$ in 17 mm	6 in 152 mm



## Frazier Dural Separator

CODE	DESCRIPTION	BLADE DEPTH	LENGTH
65-1100	Tapered Blade Width $\frac{1}{16}$ in to $\frac{1}{8}$ in (2.0 to 3.0 mm)	$\frac{1}{2}$ in 13 mm	$6\frac{1}{2}$ in 166 mm

## Elevators



65-6620



55-7026

### Freer Elevator

CODE	DESCRIPTION	WIDTH	LENGTH
65-6620	Double-Ended, Sharp and Blunt Ends	4.5 mm	7¼ in 184 mm
55-7027	Double-Ended, Sharp and Blunt Ends	4.5 mm	7½ in 191 mm
55-7026	Double-Ended, Sharp and Blunt Ends	6.5 mm	7½ in 191 mm



65-1101

### Hoehn Dural Separator

CODE	DESCRIPTION	BLADE WIDTH	BLADE LENGTH	LENGTH
65-1101	#1, 90° Angle	⅛ in 3.0 mm	½ in 13 mm	6 in 152 mm
65-1102	#2, 45° Angle	⅛ in 3.0 mm	½ in 13 mm	6½ in 166 mm



65-1002

### Hoehn Periosteal Elevator

CODE	DESCRIPTION	BLADE WIDTH	LENGTH
65-1001	#1	⅝ in 8.0 mm	7 in 178 mm
65-1003	#1	¾ in 20 mm	7½ in 191 mm
65-1002	#2	⅝ in 16 mm	7¼ in 184 mm



### Iowa University Periosteal Elevator

CODE	BLADE WIDTH	LENGTH
65-1001	1⅛ in 17 mm	7¼ in 184 mm

## Elevators



65-2510

## Langenbeck Periosteal Elevator

CODE	BLADE WIDTH		LENGTH	
65-2510	¼ in	6.0 mm	7½ in	191 mm
65-2513	¼ in	6.0 mm	7½ in	191 mm
65-2511	⅜ in	10 mm	7½ in	191 mm
65-2512	½ in	13 mm	7½ in	191 mm
65-2514	1 in	25 mm	7½ in	191 mm



65-1115

## Langenbeck Periosteal Elevator

CODE	DESCRIPTION	BLADE WIDTH		LENGTH	
65-1115	Narrow Blade	¼ in	6.0 mm	8¼ in	210 mm
65-1116	Wide Blade	⅛ in	17 mm	7½ in	191 mm



## Love-Adson Periosteal Elevator

CODE	DESCRIPTION	BLADE WIDTH		LENGTH	
65-1110	Semi-Sharp	⅜ in	5.0 mm	6½ in	165 mm



## Molt Periosteal Elevator #9

CODE	LENGTH
32-3420	7¼ in 184 mm

## Elevators

### Periosteal Elevators



65-1056

CODE	DESCRIPTION	TIP WIDTH	LENGTH
65-1056	#1, Sharp	$\frac{3}{16}$ in 5.0 mm	8 in 203 mm
65-1057	#2, Sharp	$\frac{1}{4}$ in 6.4 mm	8 in 203 mm
65-1058	#3, Sharp	$\frac{5}{16}$ in 8.0 mm	8 in 203 mm
65-1059	Sharp	$\frac{15}{32}$ in 12 mm	8 in 203 mm



65-1005

### Presbyterian Hospital Staphylorrhaphy Elevator

Double-Ended, Semi-Sharp and Sharp Blades

CODE	DESCRIPTION	LENGTH
65-1005	Straight	7 in 178 mm
65-1006	Curved	7 in 178 mm

## Extractors

### Schaumberg Comedone Extractor

CODE	DESCRIPTION	LENGTH
43-3812	Small Loop Crimped	$5\frac{3}{4}$ in 148 mm



## Forceps (Artery)

### Sarot Artery Forceps

CODE	DESCRIPTION	LENGTH
30-8059	Slightly Curved, Jaw Length $2\frac{1}{4}$ in (57 mm)	9 in 229 mm
54-5002	Curved	$9\frac{1}{2}$ in 241 mm
54-4900	Curved	11 in 279 mm
54-4905	Curved	13 in 330 mm
32-3548	Curved	14 in 356 mm



30-8059

## Forceps (Artery)

### Adson Artery Forceps

CODE	DESCRIPTION	LENGTH
16-4019	Straight, Standard Pattern	7¼ in 184 mm
16-4021	Straight, Standard Pattern	8¼ in 210 mm
16-4118	Curved, Delicate Pattern	7⅛ in 181 mm
16-4119	Curved, Standard Pattern	7¼ in 184 mm
16-4121	Curved, Standard Pattern	8¼ in 210 mm



16-4019

### Carmalt Artery Forceps

Jaws with Longitudinal Serrations, Cross-Serrated Tips

CODE	DESCRIPTION	LENGTH
16-3616	Straight	6½ in 165 mm
16-3716	Curved	6½ in 165 mm
16-3720	Curved	8⅞ in 225 mm
16-3723	Curved	9 in 229 mm



16-3616

### Crafoord (Coller) Artery Forceps

Delicate Pattern

CODE	DESCRIPTION	LENGTH
16-1520	Curved	7¾ in 197 mm
16-1524	Curved	9 in 229 mm
16-1519	Strong Curve	7 in 178 mm
16-5123	Angled 90°	9½ in 241 mm



16-1520

### Crile-Baby Artery Forceps

Delicate Pattern

CODE	DESCRIPTION	LENGTH
15-2414	Straight	5½ in 140 mm
15-2514	Curved	5¾ in 146 mm



15-2414

## Forceps (Artery)

### Harrington Artery Forceps

CODE	DESCRIPTION	LENGTH
16-3727	Curved	10 <sup>3</sup> / <sub>4</sub> in 273 mm



### Heiss Artery Forceps

CODE	DESCRIPTION	LENGTH
16-5024	Straight, Delicate Pattern	9 <sup>1</sup> / <sub>2</sub> in 241 mm
16-5124	Curved, Delicate Pattern	9 <sup>1</sup> / <sub>4</sub> in 235 mm
16-5190	Right Angle 90° Delicate Pattern	8 in 203 mm
16-5194	Right Angle 90° Delicate Pattern	9 <sup>1</sup> / <sub>2</sub> in 241 mm



16-5024

### Micro Hartmann Mosquito Artery Forceps

Very Delicate Pattern

CODE	DESCRIPTION	LENGTH
15-3009	Straight	3 <sup>1</sup> / <sub>2</sub> in 89 mm
15-3109	Curved	3 <sup>1</sup> / <sub>2</sub> in 89 mm



15-3009

### Nissen Artery Forceps

CODE	DESCRIPTION	LENGTH
16-4025	Curved	7 <sup>1</sup> / <sub>4</sub> in 184 mm



## Forceps (Artery)

### Rochester-Mixer Artery Forceps

CODE	DESCRIPTION	LENGTH
17-0736	Angled 80°	6¼ in 159 mm
17-0740	Angled 80°	8 in 203 mm



17-0736

### Rochester-Pean Baby Artery Forceps

CODE	DESCRIPTION	LENGTH
15-2914	Curved Delicate Pattern	5½ in 140 mm

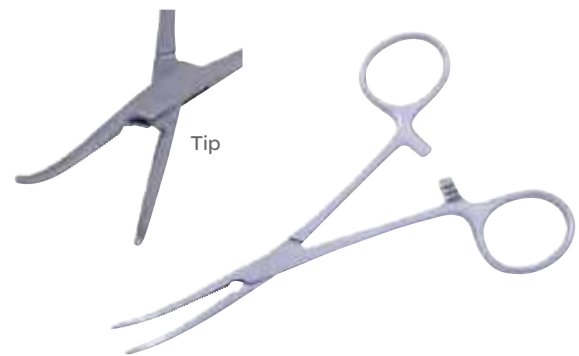

### Wikstroem Artery Forceps

CODE	DESCRIPTION	LENGTH
17-0770	Angled 90°	8¼ in 210 mm

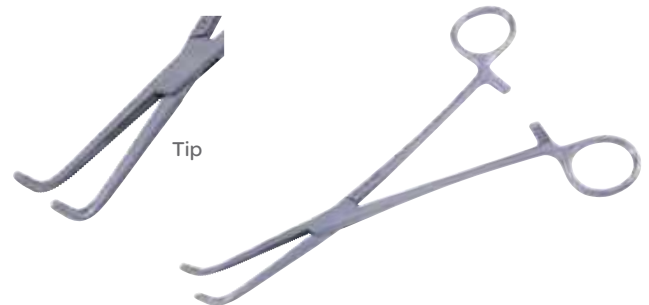

### Coller-Crile Artery Forceps

Delicate

CODE	DESCRIPTION	LENGTH
15-7284	Straight	5½ in 140 mm
15-7286	Straight	6¼ in 159 mm
15-7384	Curved	5½ in 140 mm
15-7386	Curved	6¼ in 159 mm



15-7284



## Forceps (Artery)

### Crile Artery Forceps

CODE	DESCRIPTION	LENGTH
15-7214	Straight	5½ in 140 mm
15-7216	Straight	6¼ in 159 mm
15-7314	Curved	5½ in 140 mm
15-7316	Curved	6¼ in 159 mm



15-7214

### Kelly Artery Forceps

CODE	DESCRIPTION	LENGTH
15-7014	Straight	5⅝ in 143 mm
15-7016	Straight	6¼ in 159 mm
15-7114	Curved	5½ in 140 mm
15-7116	Curved	6¼ in 159 mm



15-7014

### Leriche Artery Forceps

CODE	DESCRIPTION	LENGTH
15-5615	Straight	6 in 152 mm
15-5715	Curved	6 in 152 mm



15-5615

### Phaneuf Artery Forceps

CODE	DESCRIPTION	LENGTH
16-8021	Straight, 1x2 Teeth	8½ in 216 mm



## Forceps (Artery & Intestinal)

### Allen-Kocher Artery & Intestinal Forceps

Longitudinal Serrations

CODE	DESCRIPTION	LENGTH
15-8416	Straight, 1 x 2 Teeth	6 ¼ in 159 mm
15-8420	Straight, 1 x 2 Teeth	8 in 203 mm



15-8416

### Bainbridge Artery & Intestinal Forceps

Standard Pattern

CODE	DESCRIPTION	LENGTH
15-8216	Straight	7 ½ in 191 mm
15-8316	Curved	7 ½ in 191 mm



15-8216

## Forceps (Bayonet)

### Adson Hypophyseal Forceps

Bayonet

CODE	CUP I.D.	WORKING DISTANCE	LENGTH
30-1000	¼ in 6.0 mm	4 ½ in 114 mm	9 in 229 mm



### Cushing Bayonet Forceps

CODE	DESCRIPTION	LENGTH
07-2618	Serrated, Dissector End	7 ¼ in 184 mm
07-2619	Serrated, Dissector End	7 ½ in 191 mm
07-2718	1 x 2 Teeth, Dissector End	7 ¼ in 184 mm
07-2618-R	Round End	7 ¼ in 184 mm



07-2618

## Forceps (Bayonet)

### D'errico Bayonet Forceps

Bayonet Shape

CODE	DESCRIPTION	LENGTH
58-1547	Serrated	8 <sup>3</sup> / <sub>4</sub> in 222 mm
58-1548	1x2 Teeth	8 <sup>3</sup> / <sub>4</sub> in 222 mm



58-1547

### Gruenwald Bayonet Forceps

CODE	DESCRIPTION	LENGTH
07-3019XL	Serrated	9 <sup>1</sup> / <sub>2</sub> in 241 mm
07-3020	Serrated Tips	7 <sup>3</sup> / <sub>4</sub> in 197 mm



07-3019XL

### Jacobson Bayonet Forceps

Delicate Teeth

CODE	DESCRIPTION	LENGTH
58-1533	Sharp Tips	7 <sup>1</sup> / <sub>4</sub> in 184 mm
58-1532	Blunt Tips	7 <sup>3</sup> / <sub>8</sub> in 187 mm



58-1533

### Lucae Ear Forceps

Bayonet Shape

CODE	DESCRIPTION	LENGTH
30-6898	2.0 mm Tip, Working Distance 2 <sup>3</sup> / <sub>4</sub> in (70 mm)	5 <sup>1</sup> / <sub>2</sub> in 140 mm



## Forceps (Bayonet)

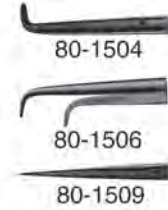

### Verity™ Forceps

Bayonet, Titanium, Working Distance 3 ¾ in (95 mm)

CODE	DESCRIPTION	TIP WIDTH	WORKING DISTANCE	LENGTH
80-1509	Straight, Extra-Fine Tip	0.25 mm	3 ¾ in 95 mm	8 ¾ in 222 mm
80-1503	Straight, Fine Tip	0.5 mm	3 ¾ in 95 mm	8 ¾ in 222 mm
80-1502	Straight, Blunt Tip	0.75 mm	3 ¾ in 95 mm	8 ¾ in 222 mm
80-1505	Angled Up, Fine Tip	0.5 mm	3 ¾ in 95 mm	8 ½ in 216 mm
80-1507	Angled Down, Fine Tip	0.5 mm	3 ¾ in 95 mm	8 ½ in 216 mm
80-1504	90° Curved Up, Blunt Tip	0.75 mm	3 ¾ in 95 mm	8 ½ in 216 mm
80-1506	90° Curved Down, Blunt Tip	0.75 mm	3 ¾ in 95 mm	8 ½ in 216 mm

### Yasargil Bayonet Forceps

CODE	DESCRIPTION	LENGTH
58-1544	Blunt Tips	9 ¼ in 230 mm
58-1546	Sharp Tips	9 ¼ in 230 mm



### Adson Cushing Bayonet Forceps

CODE	DESCRIPTION	LENGTH
07-2620	Serrated Tips	7 ¾ in 197 mm



## Forceps (Bayonet)

### Hoehn Bayonet Forceps

CODE	DESCRIPTION	LENGTH
58-1550	Serrated, Gutsch Handle	7 <sup>5</sup> / <sub>8</sub> in 194 mm



### Hoehn Alligator Forceps

CODE	DESCRIPTION	LENGTH
30-1230	Tip Width 2.2 mm, 1x2 Teeth	5 <sup>1</sup> / <sub>2</sub> in 140 mm

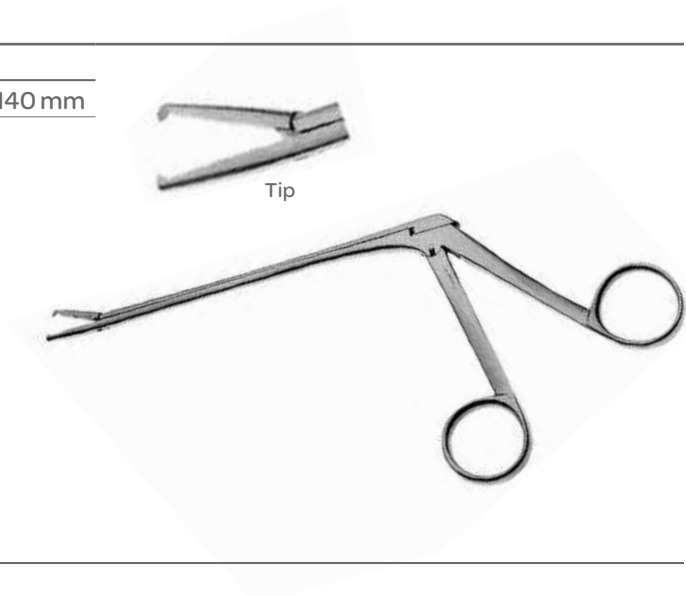

## Forceps (Bipolar)

### Adson Bipolar Forceps

Smooth Jaw

CODE	DESCRIPTION	LENGTH
08-0004	Non-insulated, 1.0 mm Tip	5 in 127 mm
08-0004I	Insulated, 1.0 mm Tip	4 <sup>3</sup> / <sub>4</sub> in 121 mm



08-0004

## Forceps (Bipolar)

### Coaptation Bipolar Forceps

CODE	DESCRIPTION	LENGTH
08-0048	0.4 mm Tip	4½ in 114 mm

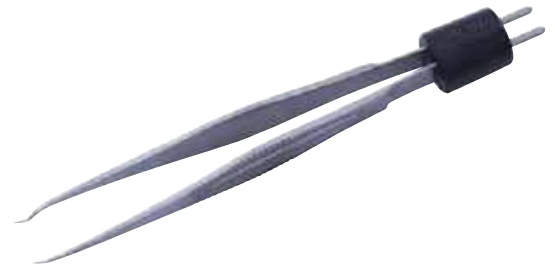

### Coaptation Bipolar Forceps

CODE	DESCRIPTION	LENGTH
08-0008	Straight, 0.5 mm Tip	4¼ in 108 mm

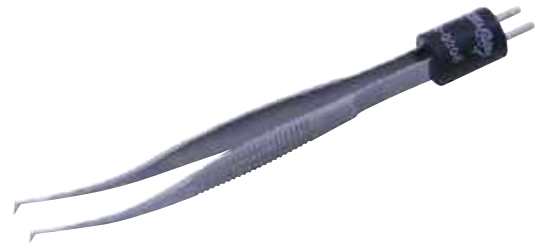

### Gerald Bipolar Forceps

CODE	DESCRIPTION	LENGTH
08-0012	Straight, 1.0 mm Tip	7⅛ in 181 mm



### Jewelers Bipolar Forceps

0.4 mm Tips

CODE	DESCRIPTION	LENGTH
08-0002	Curved	4⅜ in 111 mm
08-0005	Curved Arc	4 in 102 mm



08-0005

## Forceps (Bipolar)

### Jewelers Titanium Bipolar Forceps

0.4 mm Tips, Titanium

CODE	DESCRIPTION	LENGTH
08-0054	Straight Tip, Titanium	3½ in 89 mm
08-0057	Straight Tip, Titanium	4¼ in 108 mm
08-0052	30° Angle Tip	3½ in 89 mm
08-0056	90° Angle Tip	4¼ in 108 mm
08-0053	Curved Tip	3½ in 89 mm



08-0054

### McPherson Iris Bipolar Forceps

CODE	DESCRIPTION	LENGTH
08-0007	Angled, 0.25 mm Tip	3½ in 89 mm



### Rhoton® Bayonet Bipolar Forceps

Straight, Titanium

CODE	DESCRIPTION	LENGTH
08-01221	0.5 mm Tip Insulated	9½ in 241 mm
08-0509	1.5 mm	



08-01221

### Rhoton® Titanium Bipolar Forceps

CODE	DESCRIPTION	LENGTH
08-0058	0.5 mm Tips Round Handle	6 in 152 mm
08-0130	1.0 mm Tips	7 in 178 mm
08-0061	Curved 0.5 mm Tips Titanium, Round Handle	7⅛ in 181 mm



08-0061

## Forceps (Bipolar)

### Tenzel Bipolar Forceps

CODE	DESCRIPTION	LENGTH
08-0003	0.5 mm Tip, with Stop Curved Arc	4 in 102 mm



### Bayonet Bipolar Titanium Forceps

Titanium

CODE	DESCRIPTION	TIP WIDTH	LENGTH
08-0020	Straight	1.0 mm	8½ in 216 mm
08-0062NS	Straight, Non-Stick	1.5 mm	8¾ in 222 mm
08-0101	Straight	1.5 mm	9 in 229 mm
08-0104	Angled Down	0.5 mm	8¾ in 222 mm
08-0105	Curved Up	0.75 mm	8¾ in 222 mm



### Cushing Bayonet Bipolar Forceps

CODE	DESCRIPTION	LENGTH
08-0000I	0.7 mm Tips, Insulated	7½ in 191 mm
08-0026I	1.0 mm Tips, Insulated	7½ in 191 mm
08-0027I	1.0 mm Tips, Insulated	7½ in 191 mm
08-0026IG	1.0 mm Tips, Insulated, Irrigating	7½ in 191 mm
08-0000	0.7 mm Tips	7½ in 191 mm
08-0026	1.0 mm Tips	7½ in 191 mm
08-0027	1.5 mm Tips	7½ in 191 mm

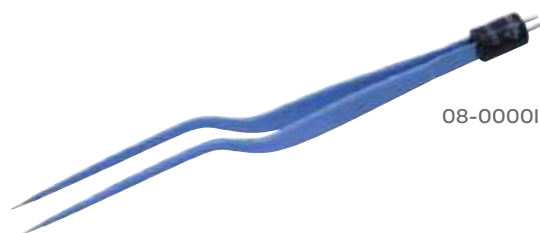



## Forceps (Bipolar)

### Gerald Bayonet Bipolar Forceps

1.0 mm Tips

CODE	DESCRIPTION	LENGTH
08-0013	Non-Insulated	7½ in 191 mm
08-0013IG	Insulated, Irrigating	7½ in 191 mm
08-0041	Irrigating	7½ in 191 mm



08-0013

### Hardy™ Bayonet Bipolar Forceps

0.5 mm Tips without Stop

CODE	DESCRIPTION	LENGTH
08-0043	Non-Insulated	8½ in 216 mm
08-0043I	Insulated Flat Handle	8½ in 216 mm

### Olsen® Bayonet Bipolar Forceps, Non-Insulated

CODE	TIPS	DESCRIPTION	LENGTH
08-0089	1.5 mm		7¾ in 197 mm
08-0090	0.5 mm	Straight	5½ in 140 mm
08-0091	1.5 mm		7 in 178 mm
08-0100	0.5 mm	Straight, Titanium	8¾ in 222 mm
08-0108	0.75 mm	Straight, Titanium Flat Handle	8¾ in 222 mm



08-0090

### Olsen® Bayonet Bipolar Forceps, Insulated

CODE	TIPS	DESCRIPTION	LENGTH
08-0100IG	0.5 mm	Straight, Titanium Irrigating, Flat Handle	8¾ in 222 mm
08-0101IG	1.5 mm	Straight, Titanium Irrigating, Flat Handle	8¾ in 222 mm
08-0101I	1.5 mm	Straight, Titanium Flat Handle	8¾ in 222 mm
08-0100I	0.5 mm	Titanium, Flat Handle	8¾ in 222 mm
08-0075	0.25 mm	Titanium, Irrigating	8¾ in 222 mm
08-0143	0.5 mm	Straight, Irrigating, Flat Handle	7¾ in 197 mm
08-0149	1.5 mm	Insulated	8¾ in 222 mm



08-0143

## Forceps (Bipolar)

### Symmetry®-Jensen Bayonet Bipolar Forceps

CODE	DESCRIPTION	LENGTH
08-0223	0.25 mm Tip	7½ in 191 mm



### McPherson Iris Bipolar Forceps

CODE	DESCRIPTION	LENGTH
08-00071	Angled 0.5 mm Tip, Insulated	3½ in 89 mm

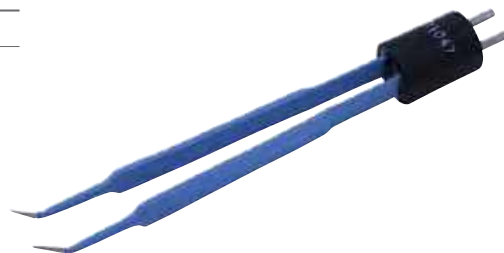

### Rhoton® Bayonet Bipolar Forceps, Non-Insulated

CODE	TIPS	DESCRIPTION	LENGTH
08-0303	0.5 mm	Straight	7⅛ in 181 mm
08-0304	0.7 mm	Straight	7⅛ in 181 mm
08-0311	1.0 mm	Straight	8⅝ in 219 mm
08-0312	1.5 mm	Straight	8⅝ in 219 mm
08-0301	2.0 mm	Straight	7⅛ in 181 mm
08-0308	0.3 mm	Straight, Round Handle	8⅝ in 219 mm
08-0309	0.5 mm	Straight, Round Handle	8⅝ in 219 mm
08-0310	0.7 mm	Straight, Round Handle	8⅝ in 219 mm
08-0319	0.7 mm	Straight, Round Handle	10 in 254 mm
08-0300	1.0 mm	Straight, Round Handle	7⅛ in 181 mm
08-0306	1.5 mm	Straight, Round Handle	7⅛ in 181 mm
08-0307	2.0 mm	Straight, Round Handle	7⅛ in 181 mm
08-0313	2.0 mm	Straight, Round Handle	8⅝ in 219 mm



## Forceps (Bipolar)

### Rhoton® Bayonet Bipolar Forceps, Insulated

CODE	TIPS	DESCRIPTION	LENGTH	
08-0028I	0.25 mm	Insulated	7 <sup>3</sup> / <sub>4</sub> in	197 mm
08-0128	1.5 mm	Titanium	9 <sup>1</sup> / <sub>2</sub> in	241 mm
08-0301I	2.0 mm	Round Handle	7 <sup>1</sup> / <sub>8</sub> in	181 mm
08-0306I	1.5 mm	Round Handle	7 <sup>3</sup> / <sub>4</sub> in	197 mm
08-0311I	1.0 mm	Round Handle	8 <sup>5</sup> / <sub>8</sub> in	219 mm
08-0312I	1.5 mm	Round Handle	8 <sup>5</sup> / <sub>8</sub> in	219 mm
08-0313I	2.0 mm	Round Handle	8 <sup>5</sup> / <sub>8</sub> in	219 mm
08-0313IG	2.0 mm	Irrigating, Round Handle	8 <sup>5</sup> / <sub>8</sub> in	219 mm



### Rhoton® Titanium Bayonet Bipolar Forceps

Round Handle

CODE	DESCRIPTION	LENGTH	
08-0120	0.5 mm Tips	8 <sup>1</sup> / <sub>2</sub> in	216 mm
08-0122	0.5 mm Tips	9 <sup>1</sup> / <sub>2</sub> in	241 mm
08-0123	1.0 mm Tip	9 <sup>1</sup> / <sub>2</sub> in	241 mm



### Scoville-Greenwood Bayonet Bipolar Forceps

1.5 mm Tips

CODE	DESCRIPTION	LENGTH	
08-0092	Non-Insulated	7 in	178 mm
08-0030	Non-Insulated	7 <sup>3</sup> / <sub>4</sub> in	197 mm
08-0030I	Insulated	7 <sup>3</sup> / <sub>4</sub> in	197 mm
08-0030IG	Irrigating, Insulated	7 <sup>3</sup> / <sub>4</sub> in	197 mm



### Yasargil Bayonet Bipolar Forceps, Non-Insulated

CODE	TIPS	DESCRIPTION	LENGTH	
08-0015	0.7 mm	Flat Handle	6 <sup>3</sup> / <sub>4</sub> in	171 mm
08-0016	1.0 mm	Flat Handle	6 <sup>3</sup> / <sub>4</sub> in	171 mm
08-0017	0.5 mm		7 <sup>1</sup> / <sub>8</sub> in	181 mm
08-0018	0.7 mm		7 <sup>1</sup> / <sub>8</sub> in	181 mm
08-0019	1.0 mm	Flat Handle	7 <sup>1</sup> / <sub>8</sub> in	181 mm
08-0022	0.7 mm		7 <sup>1</sup> / <sub>8</sub> in	181 mm
08-0023	1.0 mm	Flat Handle	7 <sup>1</sup> / <sub>8</sub> in	181 mm
08-0024	1.3 mm	Flat Handle	7 <sup>1</sup> / <sub>8</sub> in	181 mm
08-0025	1.3 mm	Flat Handle	7 <sup>1</sup> / <sub>8</sub> in	181 mm



## Forceps (Bipolar)

### Yasargil Bayonet Bipolar Forceps, Insulated

CODE	TIPS	DESCRIPTION	LENGTH
08-0022I	0.7 mm	Irrigating	7 1/8 in 181 mm
08-0023IG	1.0 mm	Insulated, Irrigating, Flat Handle	7 1/8 in 181 mm
08-0025I	1.3 mm	Insulated, Flat Handle	7 1/8 in 181 mm



08-0022I

## Forceps (Bronchus Clamp)

### Sarot Bronchus Clamp

CODE	DESCRIPTION	LENGTH
54-5751	Curved Left	9 1/4 in 235 mm
54-5752	Curved Right	9 1/4 in 235 mm



54-5752

## Forceps (Catheter)

### Magill Catheter Forceps

CODE	DESCRIPTION	LENGTH
45-7501	Infant	6 1/4 in 159 mm
45-7502	Child	7 1/2 in 191 mm
45-7503	Adult	9 1/2 in 241 mm



45-7501

### Magill Endotracheal Catheter Introducing Forceps

CODE	DESCRIPTION	LENGTH
30-4340	Adult	9 1/2 in 241 mm

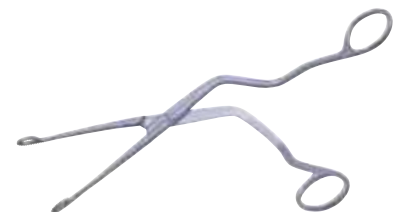

## Forceps (Combination with Needle Holder)

### Combination Needle Holder & Forceps

CODE	LENGTH
30-8002	5½ in 140 mm



## Forceps (Cystic Duct)

### Malik Cystic Duct Forceps

CODE	LENGTH
51-3369	8½ in 216 mm

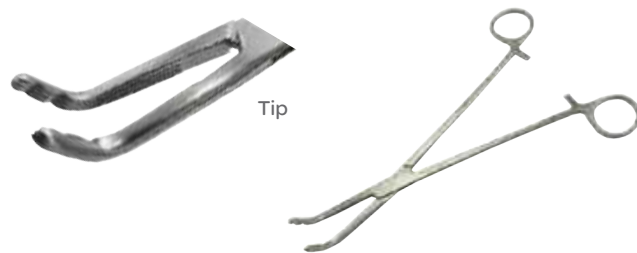

## Forceps (Dissecting)

### Mixer-Crafoord Dissecting Forceps

CODE	DESCRIPTION	LENGTH
17-0775	Angled 90°	10 in 254 mm

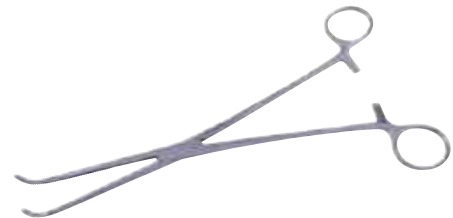

## Forceps (Dissecting and Ligature)

### Overholt Dissecting & Ligature Forceps

CODE	DESCRIPTION	LENGTH
16-6519	Curved	8¼ in 210 mm



## Forceps (Dissecting Artery)

### Rumel Dissecting Artery Forceps

CODE	DESCRIPTION	LENGTH
16-6761	Curved	9 in 229 mm



## Forceps (Dressing)

### Adson Dressing Forceps

Standard Pattern

CODE	DESCRIPTION	LENGTH
06-2012	Serrated	4 3/4 in 121 mm
06-2014	Cross-Serrated Tips	4 3/4 in 121 mm
06-2112	1x2 Teeth	4 3/4 in 121 mm

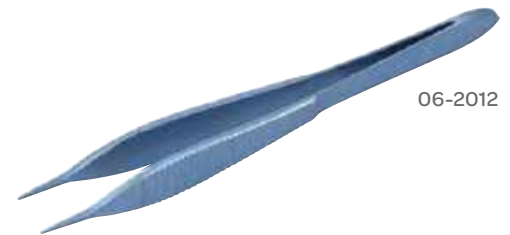

### Adson Bayonet Dressing Forceps

CODE	WORKING DISTANCE	LENGTH
30-1191	3 5/8 in 92 mm	7 1/2 in 191 mm



### Adson Dressing Forceps

CODE	DESCRIPTION	LENGTH
32-500	Tungsten Carbide Inserts	4 3/4 in 121 mm
30-1185	1.2 mm Tip, Standard Pattern	5 in 127 mm
30-1190	2.0 mm Tip, Standard Pattern	7 in 178 mm
06-2216	XL Tip	4 3/4 in 121 mm
32-501	Tungsten Carbide Inserts	6 in 152 mm
30-4214	0.8 mm Tip, Delicate Pattern	5 in 127 mm



## Forceps (Dressing)

### Bozeman Dressing Forceps

CODE	DESCRIPTION	LENGTH
19-8126	S-Shape	10 <sup>3</sup> / <sub>4</sub> in 273 mm



### Children's Hospital Classic® Delicate Dressing Forceps

CODE	DESCRIPTION	LENGTH
30-4208	1.4 mm Tip, Narrow Serrated Tips, Dissecting End	5 <sup>3</sup> / <sub>4</sub> in 146 mm



### Cosgrove Type Dressing Forceps

CODE	DESCRIPTION	LENGTH
32-518	1.0 mm Tip, Tungsten Carbide Inserts	8 in 203 mm



### Cushing Bayonet Dressing Forceps

Serrated, Bayonet, Dissecting Handle

CODE	TIP WIDTH	WORKING DISTANCE	LENGTH
30-1155	1.8 mm	3 in 76 mm	7 <sup>1</sup> / <sub>4</sub> in 184 mm
30-1156	1.4 mm	3 in 76 mm	7 <sup>3</sup> / <sub>4</sub> in 197 mm



30-1155

## Forceps (Dressing)

### Cushing Dressing Forceps

CODE	TIP WIDTH	WORKING DISTANCE	LENGTH
30-1203	2.1 mm	3¼ in 83 mm	8¾ in 222 mm



30-1203

### Cushing Dressing Forceps

CODE	DESCRIPTION	LENGTH
30-1152	1.3 mm Tip, Serrated Handle	7 in 178 mm
30-1150	1.5 mm Tip, Serrated Handle	7 in 178 mm
30-1154	1.8 mm Tip, Serrated	7¾ in 197 mm

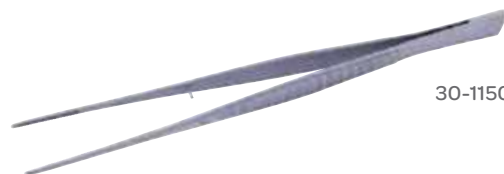

30-1150

### Dressing Forceps

Fine Serrated Handle

CODE	DESCRIPTION	LENGTH
06-0011	Standard Pattern	4½ in 114 mm
06-0013	Standard Pattern	5 in 127 mm
06-0014	Standard Pattern	5½ in 140 mm
06-0015	Standard Pattern	6 in 152 mm
06-0018	Standard Pattern	7 in 178 mm
06-0020	Standard Pattern	8 in 203 mm
06-0025	Standard Pattern	10 in 254 mm
06-0030	Standard Pattern	12 in 305 mm
06-0035	Standard Pattern	14 in 356 mm
06-0040	Standard Pattern	16 in 405 mm
06-0045	Standard Pattern	18 in 458 mm
06-0020E	Serrated, Ebonized	8 in 203 mm
06-0025E	Serrated, Ebonized	10 in 254 mm



06-0011



## Forceps (Dressing)

### Dressing Forceps

Serrated

CODE	TIP WIDTH	LENGTH	
30-4138	3.0 mm	10 in	254 mm
30-4139	3.4 mm	12 in	305 mm



30-4138

### Ewald-Hudson Dressing Forceps

CODE	DESCRIPTION	LENGTH	
30-4215	1.7 mm Tip, Serrated	5 in	127 mm
06-2001	Serrated	4 $\frac{3}{4}$ in	121 mm



06-2001

### Eye Dressing Forceps

CODE	DESCRIPTION	TIP WIDTH	LENGTH	
30-6520	Straight	1.0 mm	4 in	102 mm
30-6524	Curved	1.0 mm	4 in	102 mm



30-6520

### Gerald Bayonet Dressing Forceps

Serrated

CODE	TIP WIDTH	WORKING DISTANCE	LENGTH	
30-1216	1.3 mm	3 $\frac{1}{2}$ in 89 mm	7 $\frac{1}{2}$ in	191 mm



## Forceps (Dressing)

### Gerald Dressing Forceps

CODE	DESCRIPTION	LENGTH
30-1214	Straight Tip, Width 1.1 mm Serrated	7 in 178 mm



### Gillies Forceps

CODE	DESCRIPTION	LENGTH
06-4088	1.0 mm Tip, Cross Serrations	10 in 254 mm



### Gruenwald Bayonet Dressing Forceps

Bayonet

CODE	DESCRIPTION	LENGTH
07-3016	Serrated	6 ¼ in 159 mm
07-3019	Serrated	8 in 203 mm
07-3119	1x2 Teeth	8 in 203 mm



### Hardy™ Dressing Forceps

Bayonet

CODE	TIP WIDTH	WORKING DISTANCE	LENGTH
30-1205	1.0 mm	4 ½ in 114 mm	8 ¼ in 210 mm



## Forceps (Dressing)

### Hoehn Bayonet Dressing Forceps

Serrated, Gutsch Handle

CODE	DESCRIPTION	LENGTH
30-1165	Tip Width 2.0 mm Working Distance 3 in (76 mm)	7 <sup>3</sup> / <sub>4</sub> in 197 mm



### Jansen Bayonet Dressing Forceps

CODE	DESCRIPTION	LENGTH
30-1160	Serrated Tip, Tip Width 1.8 mm, Working Distance 4 <sup>3</sup> / <sub>8</sub> in (121 mm)	8 <sup>1</sup> / <sub>2</sub> in 216 mm
30-6995	Serrated Tip, Tip Width 2.0 mm, Working Distance 3 <sup>1</sup> / <sub>8</sub> in (80 mm)	6 <sup>1</sup> / <sub>2</sub> in 165 mm



30-1160

### Lucae Bayonet Dressing Forceps

CODE	DESCRIPTION	LENGTH
07-3014	Serrated	5 <sup>3</sup> / <sub>4</sub> in 146 mm
07-3114	1 x 2 Teeth	5 <sup>3</sup> / <sub>4</sub> in 146 mm



07-3014

## Forceps (Dressing)

### Potts-Smith Dressing Forceps

CODE	DESCRIPTION	LENGTH
30-8020	1.4 mm Tip	7¼ in 184 mm
30-8022	1.5 mm Tip, Serrated	9½ in 241 mm
30-8122	1.6 mm Tip, Serrated	12 in 305 mm
06-4638	Serrated	14 in 356 mm



06-4638

### Rhoton® Dressing Forceps

CODE	DESCRIPTION	LENGTH
80-1732	1.8 mm Tip Serrated, Titanium	7 in 178 mm



### Semken Dressing Forceps

Serrated

CODE	DESCRIPTION	LENGTH
06-3012	Straight	5 in 127 mm
06-3112	Straight	5 in 127 mm
06-3022	Curved	5 in 127 mm
30-1180	Tip Width 1.3 mm	5 in 127 mm



06-3012

## Forceps (Gall Stone)

### Blake Gall Stone Forceps

CODE	DESCRIPTION	LENGTH
51-4020	Straight	8 in 203 mm

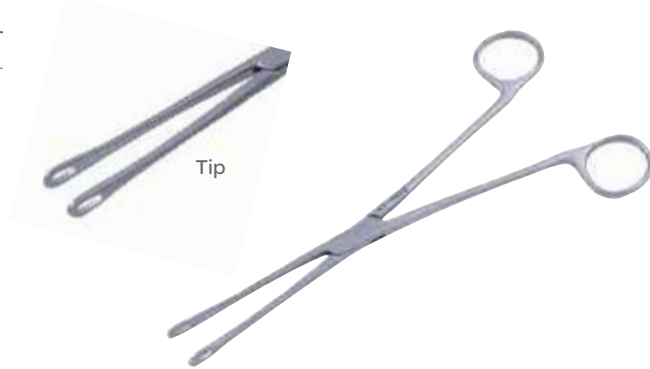

### Desjardins Gall Stone Forceps

Curved Jaws with Atraumatic Serrations 2½ in (64 mm)

CODE	DESCRIPTION	LENGTH
51-4301	Small Jaws	9 in 229 mm
51-4302	Large Jaws	9¼ in 235 mm

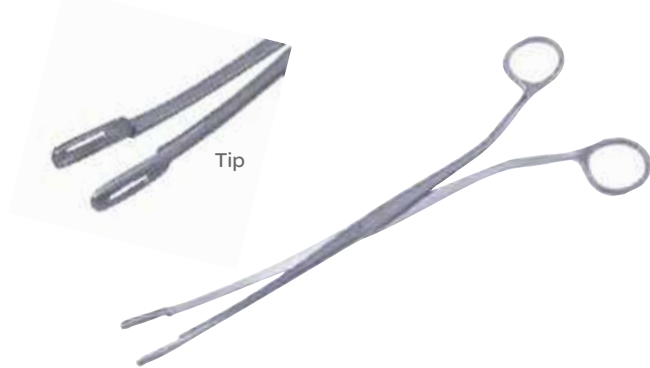

## Forceps (Gallbladder)

### Moynihan Gallbladder Duct Forceps

CODE	DESCRIPTION	LENGTH
30-4295	Curved	8½ in 216 mm



## Forceps (Gastrointestinal)

### Glassman Gastrointestinal Forceps

4 ½ in (102 mm) Jaws with 2 x 2 Atraumatic Traumatic Serrations, Sturdy Pattern

CODE	DESCRIPTION	LENGTH
50-3028	Straight	11 in 279 mm
50-3128	Angled	11 in 279 mm



### Mayo-Robson Gastrointestinal Forceps

CODE	DESCRIPTION	LENGTH
50-1825	Straight	10 in 254 mm



## Forceps (Goiter)

### Lahey Goiter Traction Forceps

CODE	DESCRIPTION	LENGTH
73-7233	3 x 3 Sharp Teeth	6 in 152 mm



### Lahey Goiter Tenaculum

CODE	DESCRIPTION	LENGTH
30-4088	3 x 3 Sharp Teeth	6 ¼ in 159 mm



## Forceps (Hemostatic)

### Adson Hemostatic Forceps

Delicate Pattern, 1 x 2 Teeth

CODE	DESCRIPTION	LENGTH
16-4218	Straight	7 $\frac{1}{8}$ in 181 mm
16-4318	Curved	7 $\frac{1}{8}$ in 181 mm



16-4318

### Adson-Baby Hemostatic Forceps

CODE	DESCRIPTION	LENGTH
17-0519	Curved, Very Delicate	7 $\frac{1}{2}$ in 191 mm



### Adson Hemostatic Forceps

CODE	DESCRIPTION	LENGTH
30-1010	Straight	7 $\frac{1}{4}$ in 184 mm
30-1011	Curved	7 $\frac{1}{4}$ in 184 mm



30-1010

### Skillman Forceps

CODE	DESCRIPTION	LENGTH
30-4009	Curved	5 in 127 mm



## Forceps (Hemostatic)

### Crile Classic® Delicate Hemostatic Forceps

CODE	DESCRIPTION	LENGTH
30-4467	Straight	5½ in 140 mm
30-4468	Curved	5½ in 140 mm



### Crile Classic® Hemostatic Forceps

CODE	DESCRIPTION	LENGTH
32-4030	Straight, Standard Line	5½ in 140 mm
32-4040	Straight, Standard Line	6¼ in 159 mm
32-4031	Curved, Standard Line	5½ in 140 mm
32-4041	Curved, Standard Line	6¼ in 159 mm
33-4030	Straight, Bright Finish	5½ in 140 mm
33-4041	Curved, Bright Finish	6¼ in 159 mm
34-4040	Straight, Low-Glare Finish	6¼ in 159 mm
34-4041	Curved, Low-Glare Finish	6¼ in 159 mm



### Adson Classic® Hemostatic Forceps

CODE	DESCRIPTION	LENGTH
30-4464	Curved	7¼ in 184 mm

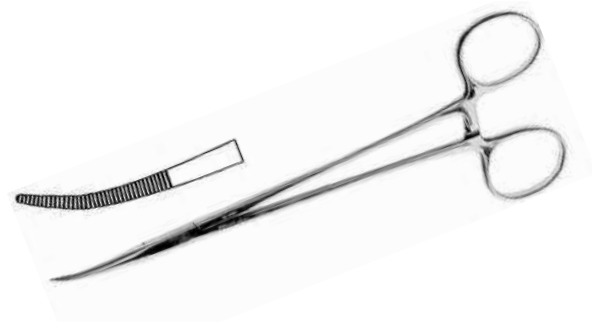



## Forceps (Hemostatic)

### Kocher Delicate Classic® Forceps

CODE	DESCRIPTION	LENGTH
30-4490	Straight, 1 x 2 Teeth	5½ in 140 mm
30-4491	Curved	5½ in 140 mm



30-4490

### Gemini Hemostatic Clamp

CODE	DESCRIPTION	LENGTH
19-5583	Curved	11 in 279 mm



### Halsted Hemostatic Forceps

CODE	DESCRIPTION	LENGTH
30-4105	Straight, 1 x 2 Teeth	5 in 127 mm
30-4038	Straight, without Teeth	7 in 178 mm
30-4106	Curved, 1 x 2 Teeth	5 in 127 mm
30-4039	Curved, without Teeth	7 in 178 mm



30-4105

### Kelly Classic® Hemostatic Forceps

CODE	DESCRIPTION	LENGTH
32-4020	Straight, Standard Line	5½ in 140 mm
33-4020	Straight, Bright Finish	5½ in 140 mm
32-4021	Curved, Standard Line	5½ in 140 mm
34-4021	Curved, Low-Glare Finish	5½ in 140 mm



33-4020

## Forceps (Hemostatic)

### Kelly Placenta Forceps

CODE	DESCRIPTION	LENGTH
30-5695	Serrated Jaw	12 in 305 mm

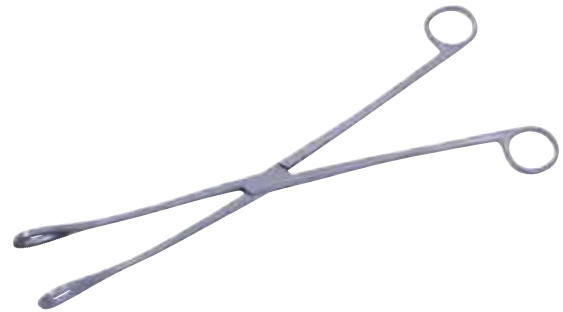

### Kocher Hemostatic Forceps

CODE	DESCRIPTION	LENGTH
16-1214	Straight, 1 x 2 Teeth	5 5/8 in 143 mm
16-1314	Curved, 1 x 2 Teeth	5 5/8 in 143 mm



### Kocher-Baby Forceps

CODE	DESCRIPTION	LENGTH
15-2014	Straight, Delicate Pattern 1 x 2 Teeth	5 1/2 in 140 mm



### Kocher Hemostatic Forceps

CODE	DESCRIPTION	LENGTH
32-4100	Straight, 1 x 2 Teeth Bright Finish	5 1/2 in 140 mm



## Forceps (Hemostatic)

### Kocher Intestinal Forceps

CODE	DESCRIPTION	LENGTH
30-4300	Straight, Longitudinal Serrations	11 in 279 mm



### Mosquito Classic® Delicate Hemostatic Forceps

CODE	DESCRIPTION	LENGTH
30-4471	Straight	4 in 102 mm
30-4473	Straight	5 in 127 mm
30-4472	Curved	4 in 102 mm
30-4474	Curved	5 in 127 mm
30-4470	Curved	6 in 152 mm



30-4470

### Pean Classic® Delicate Hemostatic Forceps

CODE	DESCRIPTION	LENGTH
30-4462	Curved	5½ in 140 mm



## Forceps (Hemostatic)

### Providence Hospital Hemostatic Forceps

CODE	DESCRIPTION	LENGTH
32-4011	Curved, Bright Finish	5½ in 140 mm



### Rankin Hemostatic Forceps

CODE	DESCRIPTION	LENGTH
32-4050	Straight, Bright Finish	6¼ in 159 mm



### Rochester-Carmalt Hemostatic Forceps Bright Finish

CODE	DESCRIPTION	LENGTH
32-4141	Curved	6½ in 165 mm
32-4151	Curved	8 in 203 mm



32-4151

## Forceps (Hemostatic)

### Rochester Ochsner Forceps

1 x 2 Teeth

CODE	DESCRIPTION	LENGTH
16-1216	Straight	6¼ in 159 mm
16-1218	Straight	7¼ in 184 mm
16-1220	Straight	8 in 203 mm
16-1222	Straight	8¾ in 222 mm
16-1224	Straight	9½ in 241 mm
16-1226	Straight	10 in 254 mm
16-1228	Straight	12 in 305 mm
16-1240	Straight	16 in 406 mm
16-1245	Straight	18 in 458 mm
16-1316	Curved	6¼ in 159 mm
16-1318	Curved	7¼ in 184 mm
16-1320	Curved	8 in 203 mm
16-1322	Curved	8¾ in 222 mm
16-1324	Curved	9½ in 241 mm
16-1326	Curved	10 in 254 mm
16-1328	Curved	12 in 305 mm
16-1330	Curved	14 in 356 mm
16-1340	Curved	16 in 406 mm
16-1345	Curved	18 in 458 mm



16-1328

### Rochester-Pean Hemostatic Forceps

CODE	DESCRIPTION	LENGTH
32-3553	Curved	12 in 305 mm
32-3554	Curved	14 in 356 mm
30-4565	Curved, Cross-Serrations	9 in 229 mm
30-4573	Curved, Cross-Serrations	10 in 254 mm

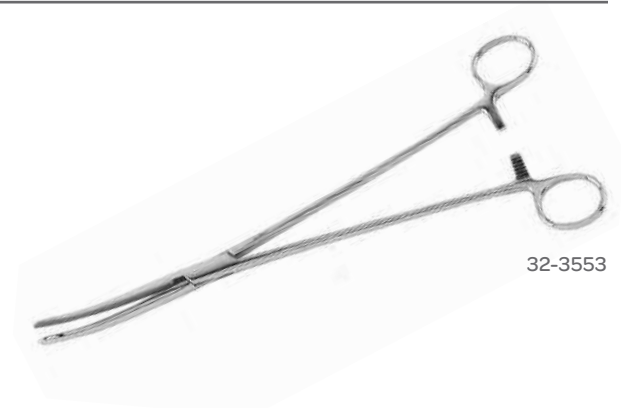

32-3553

### Rochester-Carmalt Hemostatic Forceps

CODE	DESCRIPTION	LENGTH
30-8092	Curved Longitudinal Serrations	12¼ in 311 mm



## Forceps (Hemostatic)

### Rochester-Pean Hemostatic Forceps

CODE	DESCRIPTION	LENGTH
16-1014	Straight	5½ in 140 mm
16-1016	Straight	6¼ in 159 mm
16-1018	Straight	7¼ in 184 mm
16-1020	Straight	8 in 203 mm
16-1022	Straight	8¾ in 222 mm
16-1024	Straight	9½ in 241 mm
16-1026	Straight	10¼ in 260 mm
16-1030	Straight	14 in 356 mm
16-1114	Curved	5½ in 140 mm
16-1116	Curved	6½ in 165 mm
16-1118	Curved	7¼ in 184 mm
16-1120	Curved	8 in 203 mm
16-1122	Curved	8¾ in 222 mm
16-1124	Curved	9½ in 241 mm
16-1126	Curved	10¼ in 260 mm
16-1128	Curved	11¾ in 298 mm
16-1130	Curved	14 in 356 mm
16-1140	Curved	16 in 406 mm
16-1145	Curved	18 in 458 mm



16-1014

### Rochester-Pean Forceps

CODE	DESCRIPTION	LENGTH
30-4563	Straight, Cross-Serrations	9 in 229 mm
30-8093	Curved	12 in 305 mm



30-4563

## Forceps (Hemostatic)

### Rochester-Ochsner Forceps

CODE	DESCRIPTION	LENGTH
32-4110	Straight, 1 x 2 Teeth	6 ¼ in 159 mm
32-4120	Straight, 1 x 2 Teeth	7 ¼ in 184 mm
32-4130	Straight, 1 x 2 Teeth	7 ¼ in 184 mm
33-4110	Straight, 1 x 2 Teeth, Bright Finish	6 ¼ in 159 mm
33-4120	Straight, 1 x 2 Teeth, Bright Finish	7 ¼ in 184 mm
34-4110	Straight, 1 x 2 Teeth, Low-Glare Finish	6 ¼ in 159 mm
34-4120	Straight, 1 x 2 Teeth, Low-Glare Finish	7 ¼ in 184 mm
32-4111	Curved, 1 x 2 Teeth	6 ¼ in 159 mm
32-4121	Curved, 1 x 2 Teeth	7 ¼ in 184 mm
32-4131	Curved, 1 x 2 Teeth	7 ¼ in 184 mm
30-4066	Straight	9 in 229 mm
30-8090	Straight	10 in 254 mm
32-3539	Straight, Serrated, 1 x 2 Teeth	14 in 356 mm



30-4066

### Rochester-Pean Classic® Forceps

Standard Line

CODE	DESCRIPTION	LENGTH
32-4070	Straight	6 ¼ in 159 mm
32-4080	Straight	7 ¼ in 184 mm
33-4071	Curved, Bright Finish	6 ¼ in 159 mm
32-4071	Curved	6 ½ in 165 mm
32-4081	Curved	7 ¼ in 184 mm
32-4091	Curved	8 in 203 mm



33-4071

### Schmidt Hemostatic Forceps

CODE	DESCRIPTION	LENGTH
30-4290	Full Curved	7 ¼ in 184 mm
30-4291	Slightly Curved	7 ¼ in 184 mm



## Forceps (Hysterectomy)

### Heaney Hysterectomy Forceps

Curved, Jaw Length 1½ in (38 mm)

CODE	DESCRIPTION	LENGTH
30-5525	Light Jaws, Single Tooth	8¼ in 210 mm
30-5526	Heavy Jaws, Single Tooth	8¼ in 210 mm
30-5527	Heavy Jaws, Double Tooth	8¼ in 210 mm



### Heaney-Kanter Hysterectomy Forceps

CODE	DESCRIPTION	LENGTH
30-5529	Curved, Double Tooth, Jaw Length 1¾ in (44 mm)	8½ in 216 mm



### Heaney-Rezak Hysterectomy Forceps

CODE	DESCRIPTION	LENGTH
30-5800	Straight, Single Tooth, Jaw Length 1⅞ in (48 mm)	8½ in 216 mm





## Forceps (Intestinal)

### Allen Intestinal Forceps

CODE	DESCRIPTION	LENGTH
50-1038	Straight, 1x2 Teeth	6½ in 165 mm



### Babcock Intestinal Forceps

Jaws with Atraumatic Parallel Serrations

CODE	DESCRIPTION	LENGTH
50-1116	Straight	6¼ in 159 mm
50-1123	Straight	9¾ in 238 mm

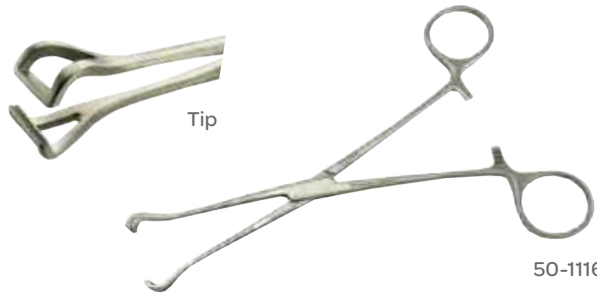

50-1116

### Doyen Intestinal Forceps

Jaws with Atraumatic Serrations

CODE	DESCRIPTION	LENGTH
50-1673	Straight	9 in 229 mm
50-1773	Curved	9 in 229 mm



50-1673

### Doyen Intestinal Forceps

Diagonal Serrations, Jaw Length 4 1/8 in (105 mm)

CODE	DESCRIPTION	LENGTH
30-4305	Straight	9¼ in 235 mm
30-4306	Curved	9¼ in 235 mm

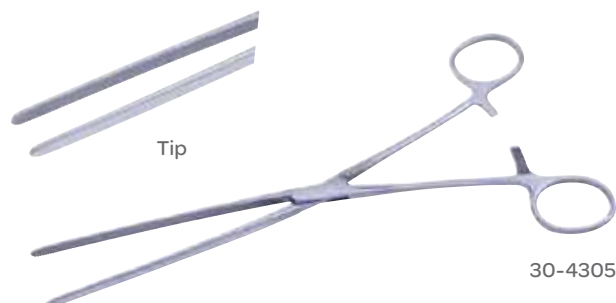

30-4305

## Forceps (Intestinal)

### Doyen-Baby Intestinal Forceps

Delicate Pattern

CODE	DESCRIPTION	LENGTH	
50-1617	Straight	7 in	178 mm
50-1717	Curved	7 in	178 mm



50-1717

## Forceps (Iris)

### Iris Forceps

Extremely Delicate

CODE	DESCRIPTION	LENGTH	
06-3010	Straight, Serrated	4 in	102 mm
06-3030	Strongly Curved, Serrated	4 in	102 mm
06-3110	Straight, 1x2 Teeth	4 in	102 mm
06-3130	Strongly Curved, 1x2 Teeth	4 in	102 mm

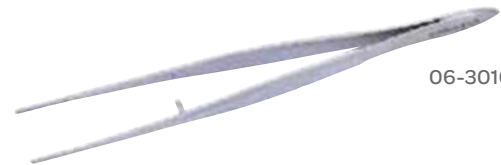

06-3010

## Forceps (Jewelers)

### Jewelers Forceps

Extra Fine Point

CODE	DESCRIPTION	LENGTH	
60-1690	Straight, Style #3	4 <sup>5</sup> / <sub>8</sub> in	117 mm
60-1692	Straight, Style #4	4 <sup>1</sup> / <sub>4</sub> in	108 mm
60-1693	Straight, Style #5	4 <sup>1</sup> / <sub>4</sub> in	108 mm
60-1694	Curved, Style #7	4 <sup>5</sup> / <sub>8</sub> in	117 mm



60-1690

## Forceps (Kidney Stone)

### Randall Kidney Stone Forceps

CODE	DESCRIPTION	LENGTH	
51-5801	#1, One Quarter Curve	9 in	229 mm
51-5802	#2, One Half Curve	9 in	229 mm
51-5803	#3, Three Quarter Curve	9 in	229 mm
51-5804	#4, Full Curve	9 in	229 mm



51-5801

## Forceps (Ligature)

### Semb Ligature Carrying Forceps

CODE	DESCRIPTION	LENGTH	
30-8056	Acute Curve	9½ in	241 mm



## Forceps (Lung Grasping)

### Lovelace Lung Grasping Forceps

CODE	DESCRIPTION	LENGTH	
54-5019	Angled to Side, 25 mm Jaw, Triangular Jaw	8 in	203 mm

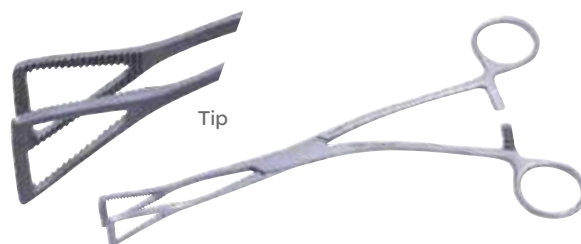

## Forceps (Micro)

### Micro Forceps

#### Straight

CODE	TIP WIDTH	LENGTH	
80-2000	0.3 mm	5½ in	140 mm
80-2009	0.3 mm	7 in	178 mm
80-2010	0.7 mm	7 in	178 mm



80-2000

## Forceps (Micro)

### Jacobson Micro Forceps

CODE	DESCRIPTION	LENGTH	
07-7015	Fine Sharp Tips	6 in	152 mm
07-7018	Fine Sharp Tips	7 $\frac{1}{8}$ in	181 mm



07-7015

### Jacobson-Adson Micro Forceps

CODE	DESCRIPTION	LENGTH	
07-6612	Sharp Tips	4 $\frac{3}{4}$ in	121 mm



## Forceps (Micro Artery)

### Jacobson Micro Artery Forceps

CODE	DESCRIPTION	LENGTH	
16-4088	Straight	7 in	178 mm
16-4188	Slight Curve	7 in	178 mm
16-4189	Full Curve	7 in	178 mm



16-4189

## Forceps (Micro Bayonet)

### Yasargil Micro Bayonet Forceps

CODE	TIP WIDTH	LENGTH	
58-1566	9.0 mm	9 $\frac{1}{2}$ in	241 mm



## Forceps (Mosquito)

### Halsted Mosquito Forceps

CODE	DESCRIPTION	LENGTH
15-4412	Straight, Standard Pattern	4 <sup>3</sup> / <sub>4</sub> in 121 mm
15-4612	Straight, 1 x 2 Teeth Standard Pattern	4 <sup>3</sup> / <sub>4</sub> in 121 mm
15-4512	Curved, Standard Pattern	4 <sup>3</sup> / <sub>4</sub> in 121 mm
15-4712	Curved, 1 x 2 Teeth Standard Pattern	4 <sup>3</sup> / <sub>4</sub> in 121 mm



15-4412

### Halsted Classic® Mosquito Forceps

Low-Glare Finish

CODE	DESCRIPTION	LENGTH
34-3900	Straight	3 <sup>1</sup> / <sub>2</sub> in 89 mm
32-3900	Straight, Standard Line	3 <sup>1</sup> / <sub>2</sub> in 89 mm
32-4000	Straight, Standard Line	5 in 127 mm
33-4000	Straight, Bright Finish	5 in 127 mm
32-3901	Curved, Standard Line	3 <sup>1</sup> / <sub>2</sub> in 89 mm
32-4001	Curved, Standard Line	5 in 127 mm
34-3901	Curved	3 <sup>1</sup> / <sub>2</sub> in 89 mm
34-4001	Curved	5 in 127 mm
33-3901	Curved, Bright Finish	3 <sup>1</sup> / <sub>2</sub> in 89 mm
33-4001	Curved, Bright Finish	5 in 127 mm



34-3900



32-3900

### Micro Halsted Mosquito Forceps

CODE	DESCRIPTION	LENGTH
15-4002	Curved	6 in 152 mm



## Forceps (Mosquito)

### Providence Hospital Mosquito Forceps

CODE	DESCRIPTION	LENGTH
15-5014	Straight	5½ in 140 mm
15-5114	Curved	5½ in 140 mm



15-5014

### Skillman Packer Mosquito Forceps

CODE	DESCRIPTION	LENGTH
15-4582	Curved	5 in 127 mm



### Micro Jacobson Mosquito Forceps

Very Slender Pattern

CODE	DESCRIPTION	LENGTH
15-3501	Straight	4 in 102 mm
15-4082	Straight	5 in 127 mm
15-3502	Curved	3⅞ in 98 mm
15-4182	Curved	4⅜ in 106 mm



15-3501

### Micro-Halsted Mosquito Forceps

Very Slender Pattern

CODE	DESCRIPTION	LENGTH
15-4012	Straight	4¾ in 121 mm
15-4112	Curved	4¾ in 121 mm



15-4012

## Forceps (Mosquito Artery)

### Hartmann-Baby Mosquito Artery Forceps

CODE	DESCRIPTION	LENGTH
15-3209	Straight	3 <sup>7</sup> / <sub>8</sub> in 98 mm
15-3309	Curved	3 <sup>7</sup> / <sub>8</sub> in 98 mm

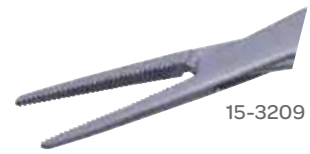

15-3209

## Forceps (Pile Clamp)

### Buie Pile Clamp

CODE	DESCRIPTION	LENGTH
16-3921	Curved	8 <sup>5</sup> / <sub>8</sub> in 219 mm



## Forceps (Skin Hook)

### Lalonde Skin Hook Forceps

CODE	DESCRIPTION	LENGTH
20-5003	Extra Fine	4 <sup>3</sup> / <sub>4</sub> in 121 mm



## Forceps (Splinter)

### Feilchenfeld Splinter Forceps

CODE	DESCRIPTION	LENGTH
07-8211	Splinter Forceps	4 <sup>1</sup> / <sub>2</sub> in 114 mm



## Forceps (Splinter)

### Ralks (Virtus) Splinter Forceps

CODE	DESCRIPTION	LENGTH
07-9424	Angled	5½ in 140 mm
07-9425	Angled	6 in 152 mm



07-9424

### Splinter Forceps

CODE	DESCRIPTION	LENGTH
07-8009	Straight	3½ in 89 mm
07-8010	Straight	4¼ in 105 mm
07-8011	Straight	4⅝ in 117 mm
07-8681	Straight, with Detachable Magnifying Glass	4⅜ in 111 mm
07-8108	Angled	3⅛ in 79 mm
07-8109	Angled	3½ in 89 mm
07-8110	Angled	4¼ in 105 mm
07-8111	Angled	4½ in 114 mm



07-8009

### Virtus Splinter Forceps

CODE	DESCRIPTION	LENGTH
30-4258	Straight, Sharp Tips	6 in 152 mm



### Walter Splinter Forceps

CODE	DESCRIPTION	LENGTH
07-8611	Straight	4¼ in 108 mm
30-4255	Straight, Sharp Tips	4¼ in 108 mm
07-8621	Curved	4⅛ in 105 mm



30-4255



## Forceps (Splinter)

### Williams Splinter Forceps

CODE	DESCRIPTION	LENGTH
07-9114	Straight	5½ in 140 mm

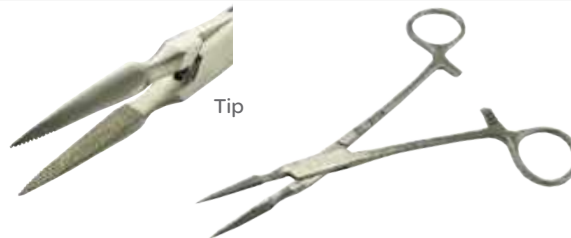

### Peet Splinter Forceps

CODE	DESCRIPTION	LENGTH
07-9011	Splinter Forceps	4½ in 114 mm



## Forceps (Sponge)

### Sponge Holding Forceps

Serrated Jaws, Bright Finish

CODE	DESCRIPTION	LENGTH
32-6010	Straight	7 in 178 mm
32-6030	Straight	9 in 229 mm
32-6031	Curved	9 in 229 mm

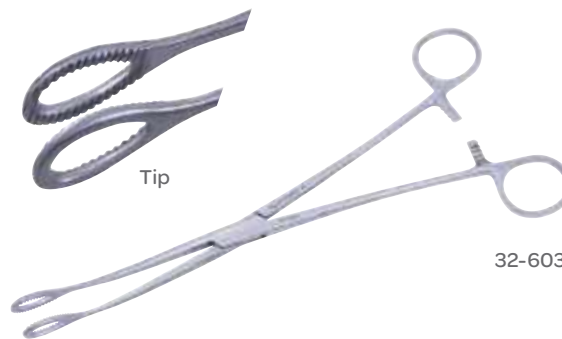

### Sponge Classic® Holding Forceps

Serrated Jaws, Bright Finish

CODE	DESCRIPTION	LENGTH
33-6031	Curved	9 in 229 mm

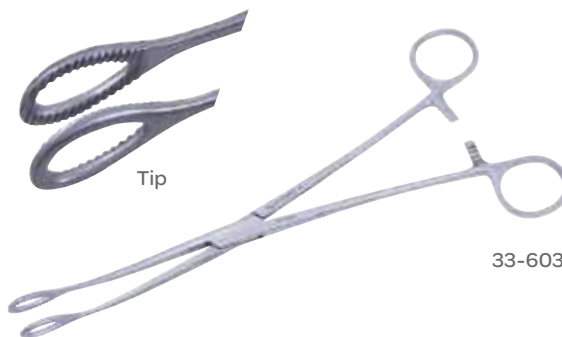

## Forceps (Sponge)

### Bariatric Sponge Forceps

CODE	DESCRIPTION	LENGTH
32-3540	Straight, Serrated Jaws	14 in 356 mm



### Bergmann-Forester Sponge Forceps

Serrated, Small Loop Jaws

CODE	DESCRIPTION	LENGTH
19-5424	Straight	9 <sup>5</sup> / <sub>8</sub> in 244 mm
19-5524	Curved	9 <sup>5</sup> / <sub>8</sub> in 244 mm

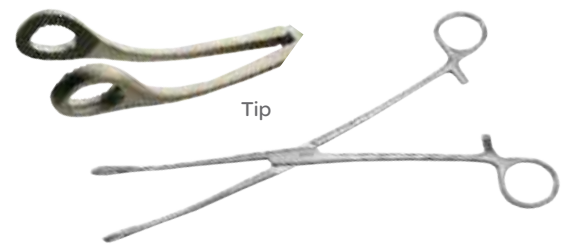

19-5524

### Fletcher (Javerts) Sponge Forceps

Serrated, Narrow Loop Jaws

CODE	DESCRIPTION	LENGTH
19-5824	Straight	9 <sup>7</sup> / <sub>8</sub> in 251 mm
19-5924	S-Shape	9 <sup>7</sup> / <sub>8</sub> in 251 mm

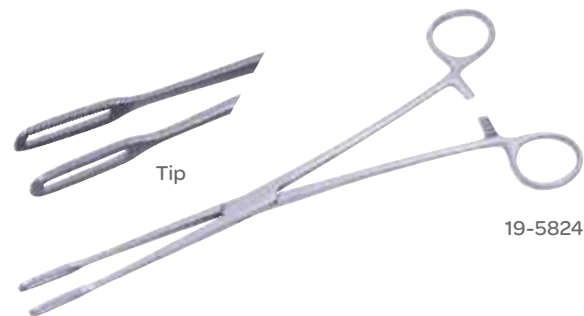

19-5824

### Foerster Sponge Forceps

CODE	DESCRIPTION	LENGTH
19-5024	Straight, Serrated Jaws	9 <sup>3</sup> / <sub>4</sub> in 248 mm
19-5029	Straight, Serrated Jaws	12 in 305 mm
19-5030	Straight, Serrated Jaws	14 in 356 mm
19-5040	Straight, Serrated Jaws	16 in 406 mm
19-5045	Straight, Serrated Jaws	18 in 458 mm
19-5224	Straight, Smooth Jaws	9 <sup>1</sup> / <sub>2</sub> in 241 mm
19-5124	Curved, Serrated Jaws	9 <sup>1</sup> / <sub>2</sub> in 241 mm
19-5324	Curved, Smooth Jaws	9 <sup>1</sup> / <sub>2</sub> in 241 mm



19-5024

## Forceps (Sponge)

### Foerster (Ballenger) Sponge Forceps

CODE	DESCRIPTION	LENGTH	
19-5017	Straight, Smooth Jaws	7 in	178 mm
19-5018	Straight, Serrated Jaws	7½ in	181 mm
19-5118	Curved, Serrated Jaws	7½ in	181 mm



19-5017

### Foerster Sponge Forceps

CODE	DESCRIPTION	LENGTH	
19-5029E	Straight, Serrated Ebonized	12 in	305 mm
19-5129	Curved, Serrated Jaws	12 in	305 mm
19-5031	Curved, Serrated Jaws	14 in	356 mm



19-5129

## Forceps (Stomach & Intestinal)

### Glassman Stomach & Intestinal Forceps

2½ in (64 mm) Jaws with Atraumatic Serrations

CODE	DESCRIPTION	LENGTH	
50-3024	Straight	9½ in	241 mm
50-3124	Angled	9¼ in	235 mm

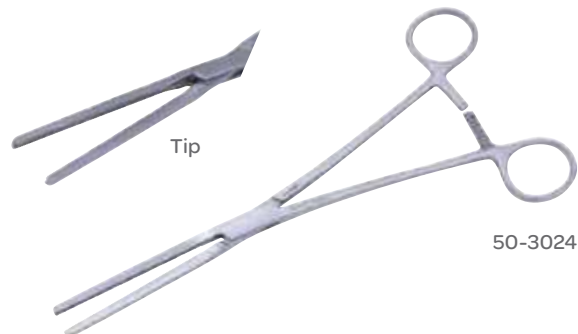

50-3024

## Forceps (Stomach Resection Clamps)

### Glassman Stomach Resection Clamps

Jaws with Serrations

CODE	DESCRIPTION	JAWS	LENGTH		
50-3225	Straight	4 1/8 in	105 mm	11 in	279 mm
50-3172	Angled 90°	2 in	51 mm	9 7/8 in	251 mm
50-3174	Angled 90°	3 in	76 mm	9 7/8 in	251 mm
50-3325	Angled	4 1/8 in	105 mm	10 1/4 in	260 mm

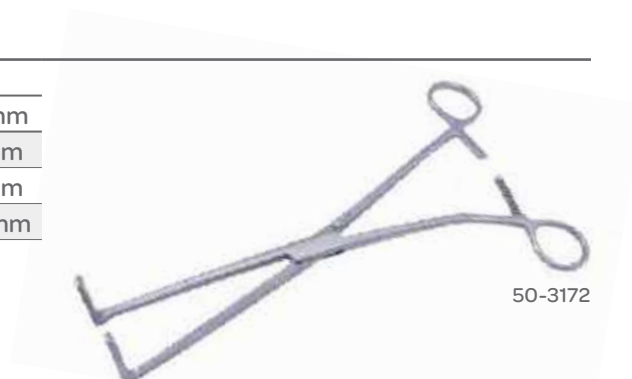

50-3172

### Forceps (Suture)

### Bonn Suture Forceps

0.12 mm Teeth, Extra Delicate

CODE	DESCRIPTION	LENGTH	
60-1641	Without Platform	3 in	76 mm
60-1660	With Platform	3 3/4 in	95 mm



60-1660

### Castroviejo Suture Forceps

With Platform, Wide Handle

CODE	TEETH	LENGTH	
60-1629	0.12 mm	4 1/4 in	108 mm
60-1631	0.3 mm	4 1/4 in	108 mm
60-1632	0.5 mm	4 1/4 in	108 mm
60-1637	0.9 mm	4 1/4 in	108 mm
60-1634	1.5 mm	4 1/4 in	108 mm
60-1630	0.12 mm, Angled on Shaft	4 1/8 in	105 mm
60-1628	0.3 mm, Angled on Shaft	4 1/8 in	105 mm
60-1627	0.5 mm, Angled on Shaft	4 1/8 in	105 mm

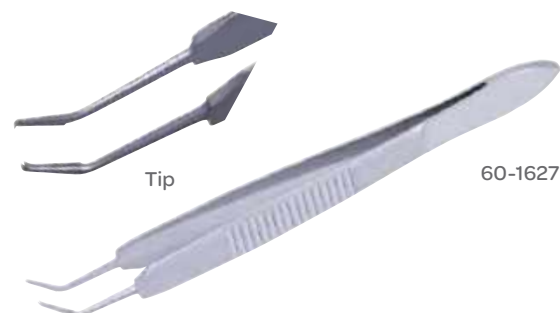

60-1627

### Micro Suture Forceps

CODE	DESCRIPTION	LENGTH	
13-7042	0.3 mm Tip, with Tying Platform, Flat Handle	4 1/8 in	105 mm



## Forceps (Suture)

### Castroviejo Suture Forceps

With Platform, 1 x 2 Teeth

CODE	TIP WIDTH	LENGTH
60-1638	0.12 mm	4¼ in 108 mm
60-1639	0.3 mm	4¼ in 108 mm
60-1635	0.5 mm	4¼ in 108 mm



60-1638

### Jaffe-Castroviejo Suture Forceps

With Platform, 1 x 2 Teeth

CODE	TIP WIDTH	LENGTH
60-1621	0.12 mm	4¼ in 108 mm



### Sauer Suture Forceps

CODE	DESCRIPTION	LENGTH
60-1650	1 x 2 Teeth at Oblique Angle to Shaft	3½ in 89 mm



## Forceps (Suture Stay)

### Castaneda Suture Tag Forceps

Smooth Jaws

CODE	DESCRIPTION	LENGTH
30-9007	#1	3½ in 89 mm
30-9008	#2	3½ in 89 mm
30-9009	#3	3½ in 89 mm
30-9010	#4	3½ in 89 mm



30-9007

## Forceps (Suture Stay)

### Gregory Suture Stay Forceps

Smooth Jaws

CODE	DESCRIPTION	JAW LENGTH	LENGTH
19-8026	#1, Gold	$\frac{5}{8}$ in 98 mm	$4\frac{3}{4}$ in 121 mm
19-8027	#2, Gold Large	$\frac{3}{4}$ in 16 mm	$4\frac{3}{4}$ in 121 mm
19-8029	#4, Gold Large	$1\frac{5}{8}$ in 19 mm	$4\frac{3}{4}$ in 121 mm
17-8026		$3\frac{7}{8}$ in 41 mm	



17-8026

## Forceps (Tebbetts)

### Tebbetts Forceps

Tungsten Carbide Inserts

CODE	TIP	LENGTH
32-551	5.0 mm	$4\frac{3}{4}$ in 121 mm
32-552	9.0 mm	$4\frac{3}{4}$ in 121 mm



32-552

## Forceps (Tendon)

### Carroll Tendon Pulling Forceps

CODE	SHAFT LENGTH	JAW DIAMETER	LENGTH
30-2540	5 in (127 mm)	$\frac{3}{8}$ in 10 mm	$7\frac{1}{2}$ in 191 mm



## Forceps (Thoracic)

### Harrington Thoracic Clamp Forceps

CODE	DESCRIPTION	LENGTH	
30-8049	Right Angled, Longitudinal Serrations with Cross-Serrated Tips	12 in	305 mm



### Julian Thoracic Artery Forceps

CODE	DESCRIPTION	LENGTH	
37-4034	Slightly Curved, 24 mm Jaw Length	9 ¼ in	235 mm



### Kantrowitz Thoracic Forceps

CODE	DESCRIPTION	LENGTH	
54-5003	Angled, Delicate, 90°	7 ½ in	191 mm
54-5000	Angled, Delicate, 90°	6 ½ in	166 mm



### Rumel Thoracic Forceps

CODE	DESCRIPTION	LENGTH	
30-8070	#1, Slight Curve	9 in	229 mm
30-8072	#2, Full Curve	9 in	229 mm
30-8073	#4, Right Angle	9 in	229 mm

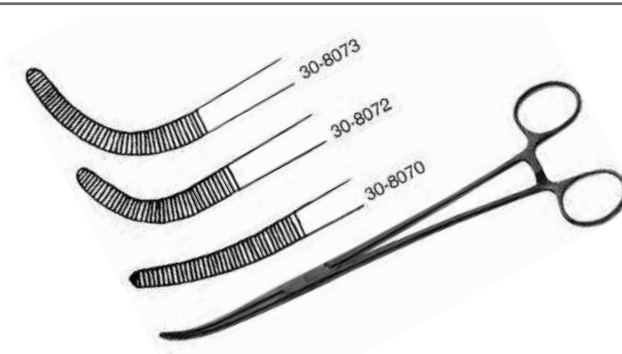

## Forceps (Tissue)

### Adair-Allis Tissue Forceps

CODE	TEETH	LENGTH
50-0417	9x10	9 in 229 mm
50-0415	9x10 Teeth	6 in 152 mm



50-0417

### Adson Tissue Forceps

CODE	TEETH	LENGTH
06-2113	1x2 with Serrations	4 3/4 in 121 mm
06-2113E	1x2 with Serrations, Ebonized	4 3/4 in 121 mm
06-2413	2x3	4 3/4 in 121 mm



06-2113

### Adson Brown Forceps

Tungsten Carbide Inserts

CODE	TEETH	LENGTH
32-502	7x7	4 3/4 in 121 mm
32-506	7x7	4 3/4 in 121 mm
32-507	7x7	6 in 152 mm
32-536	4x4	4 3/4 in 121 mm



32-502

### Adson Forceps

CODE	DESCRIPTION	LENGTH
32-512	With Hooks, Tungsten Carbide Inserts	5 in 127 mm





## Forceps (Tissue)

### Adson Tissue Forceps

Tungsten Carbide Inserts

CODE	DESCRIPTION	LENGTH
32-504	Micro, 1x2 Teeth	4 <sup>3</sup> / <sub>4</sub> in 121 mm



### Adson Tissue Forceps

Tungsten Carbide Inserts

CODE	DESCRIPTION	LENGTH
32-509	Standard, 1x2 Teeth	6 in 152 mm



### Adson Tissue Forceps

Tungsten Carbide Inserts

CODE	DESCRIPTION	LENGTH
32-503	1x2 Teeth	4 <sup>3</sup> / <sub>4</sub> in 121 mm



### Adson Tissue Forceps

CODE	TIP WIDTH	TEETH	LENGTH
30-1186	1.2 mm	1x2	5 in 127 mm
30-1187	1.8 mm	2x3	5 in 127 mm
30-1188	3.0 mm	2x3	7 in 178 mm
30-4218	0.7 mm Delicate		5 in 127 mm
36-6000	Tip Width 2.0 mm, Tungsten Carbide Inserts		4 <sup>3</sup> / <sub>4</sub> in 121 mm



36-6000

## Forceps (Tissue)

### Adson-Brown Tissue Forceps

CODE	DESCRIPTION	TEETH	LENGTH
06-2512	Straight	7x7	4 <sup>3</sup> / <sub>4</sub> in 121 mm
06-2572	Angled	7x7	4 <sup>3</sup> / <sub>4</sub> in 121 mm



06-2512

### Adson-Graefe (Beasley) Forceps

CODE	DESCRIPTION	LENGTH
06-2582	Multiple Teeth	4 <sup>3</sup> / <sub>4</sub> in 121 mm



### Adson-Brown Tissue Forceps

CODE	TIP WIDTH	TEETH	LENGTH
30-1189	1.7 mm	1x2	5 in 127 mm



### Allis Tissue Forceps

CODE	DESCRIPTION	LENGTH
50-0215	Standard Pattern, 4 x 5 Teeth	6 in 152 mm
50-0216	Standard Pattern, 5 x 6 Teeth	6 in 152 mm
50-0219	Standard Pattern, 5 x 6 Teeth	7 <sup>1</sup> / <sub>2</sub> in 191 mm
50-0223	Standard Pattern, 5 x 6 Teeth	9 <sup>1</sup> / <sub>2</sub> in 241 mm
50-0224	Standard Pattern, 5 x 6 Teeth	9 <sup>3</sup> / <sub>4</sub> in 248 mm
50-0226	Standard Pattern, 5 x 6 Teeth	12 in 305 mm
50-0245	Standard Pattern, 5 x 6 Teeth	18 in 458 mm
50-0315	Narrow Jaws, Atraumatic Parallel Serrations	6 in 152 mm
50-0320	Narrow Jaws Atraumatic Parallel Serrations	8 in 203 mm
50-0316	Jaws with Atraumatic Parallel Serrations	6 in 152 mm
50-0319	Jaws with Atraumatic Parallel Serrations	7 <sup>1</sup> / <sub>2</sub> in 191 mm

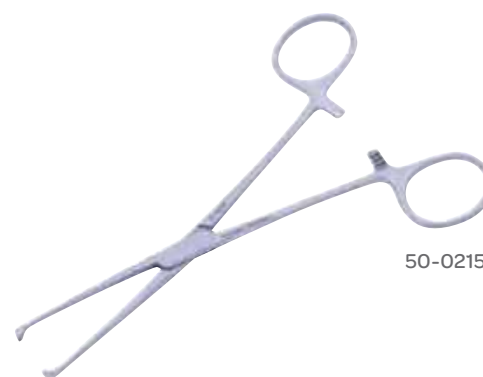

50-0215

## Forceps (Tissue)

### Allis Classic® Delicate Tissue Forceps

CODE	TEETH	LENGTH
30-4466	5 x 6	5 in 127 mm



### Allis Classic® Tissue Forceps

CODE	TEETH	DESCRIPTION	LENGTH
32-7000	4 x 5	Standard Line	6 in 152 mm
32-7001	5 x 6	Standard Line	6 in 152 mm
32-7010	5 x 6	Standard Line	7¼ in 184 mm
34-7000	4 x 5	Low-Glare Finish	

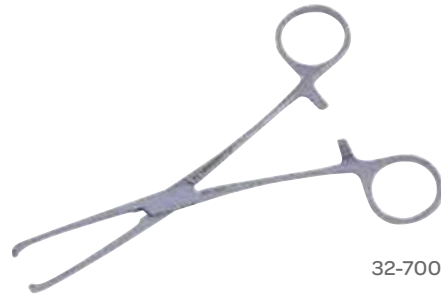

32-7001

### Allis-Adair Tissue Forceps

CODE	TEETH	LENGTH
30-4542	9 x 10	6 in 152 mm



### Allis-Baby Tissue Forceps

CODE	DESCRIPTION	LENGTH
50-0213	Delicate Pattern, 4 x 5 Teeth	5 in 127 mm



## Forceps (Tissue)

### Babcock Tissue Forceps

CODE	DESCRIPTION	LENGTH
50-1016	Standard Pattern	6¼ in 159 mm
50-1023	Standard Pattern	9½ in 241 mm
50-1024	Standard Pattern	12 in 305 mm
50-1040	Standard Pattern	16 in 405 mm
50-1045	Standard Pattern	18 in 458 mm



### Babcock Baby Tissue Forceps

CODE	DESCRIPTION	LENGTH
50-1015	Extra Delicate Jaws	6¼ in 159 mm



### Babcock Classic® Delicate

CODE	DESCRIPTION	LENGTH
30-4465	Tissue Forceps	5½ in 140 mm



### Babcock Classic® Tissue Forceps

CODE	DESCRIPTION	LENGTH
32-7020	Standard Line	6¼ in 159 mm
32-7025	Standard Line	7¾ in 197 mm
32-7030	Standard Line	9½ in 241 mm
33-7020	Bright Finish	6¼ in 159 mm
33-7025	Bright Finish	7¾ in 197 mm
34-7025	Low-Glare Finish	7¾ in 197 mm

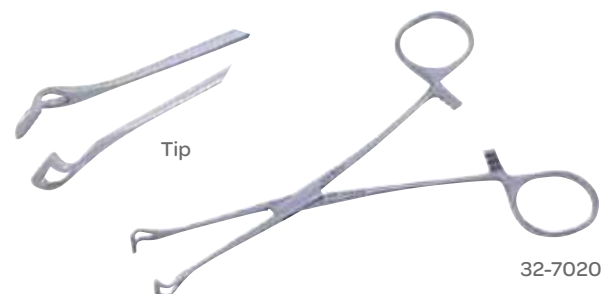

## Forceps (Tissue)

### Babcock Tissue Forceps

CODE	DESCRIPTION	LENGTH
36-6050	Tungsten Carbide Jaw Inserts	6¼ in 159 mm



### Ballentine Hysterectomy Forceps

CODE	DESCRIPTION	LENGTH
30-5801	Straight, Single Tooth Jaw Length 1¾ in (44 mm)	8½ in 216 mm



### Bariatric Tissue Forceps Babcock

CODE	DESCRIPTION	LENGTH
32-3544	Straight	12 in 305 mm
32-3545	Serrated	14 in 356 mm



32-3544

### Bariatric Forceps

CODE	DESCRIPTION	LENGTH
32-3551	Right-Angled	12¼ in 311 mm
32-3552	Right-Angled	14 in 356 mm



32-3551

## Forceps (Tissue)

### Bariatric Russian Tissue Forceps

CODE	DESCRIPTION	LENGTH
32-3543	Side Grasping Teeth	14 in 356 mm



### Bariatric Thumb Forceps

CODE	DESCRIPTION	LENGTH
32-3541	3.4 mm Tip	14 in 356 mm
32-3542	1 x 2 Teeth	14 in 356 mm



32-3541

### Barnes-Crile Classic® Forceps

CODE	DESCRIPTION	LENGTH
32-4043	Curved, Bright Finish	6 ¼ in 159 mm



### Bishop Harmon Tissue Forceps

CODE	DESCRIPTION	LENGTH
60-1524	Cross-Serrated Tips	3 ¾ in 75 mm
60-1522	1 x 2 Teeth	3 ½ in 86 mm



60-1522

## Forceps (Tissue)

### Bishop Harmon Tissue Forceps

1x2 Teeth

CODE	TIP WIDTH	LENGTH
30-6555	5.0 mm, Standard	3¼ in 83 mm
30-6556	0.3 mm, Delicate	3¼ in 83 mm



30-6555

### Bonney Tissue Forceps

CODE	TEETH	LENGTH
06-8791	1x2 Teeth	7⅞ in 181 mm
06-8782	1x2 Teeth	10 in 254 mm
06-8790	2x3 Teeth	7⅞ in 181 mm
06-8795	2x3 Teeth	12 in 305 mm



06-8791

### Bonney Tissue Forceps

CODE	TIP WIDTH	TEETH	LENGTH
30-1129	3.0 mm	1x2	6¾ in 171 mm



### Boston Lying-In Cervical Grasping Forceps

CODE	DESCRIPTION	LENGTH
30-5570	Fenestrated	9½ in 241 mm



## Forceps (Tissue)

### Boys-Allis Tissue Forceps

CODE	DESCRIPTION	LENGTH
50-0715	5 x 6 Teeth	6 in 152 mm



### Bridge Forceps

CODE	DESCRIPTION	LENGTH
54-5010	Straight	11 in 279 mm
54-5009	Curved	7½ in 191 mm
54-5011	Curved	11 in 279 mm
30-4700	Curved	11 in 279 mm

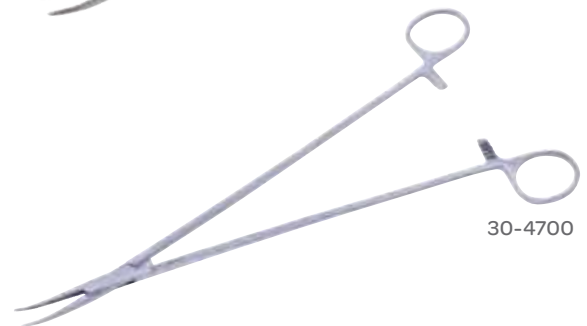

### Bridge Forceps

CODE	DESCRIPTION	LENGTH
54-5021	Curved	14 in 356 mm

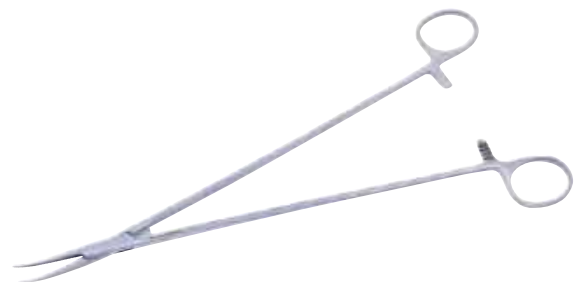



## Forceps (Tissue)

### Brigham Brain Tumor Forceps

CODE	RING JAW DIAMETER	LENGTH
30-1117	3/8 in (10 mm)	7 3/8 in 187 mm

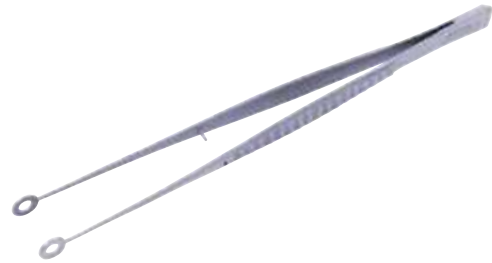

### Brigham Tissue Forceps

CODE	TIP	TEETH	LENGTH
30-4239	2.2 mm Dissecting End	1 x 2	5 1/2 in 140 mm



### Brown Tissue Forceps

CODE	DESCRIPTION	LENGTH
07-1015	Side-Grasping Teeth	6 in 152 mm
07-1020	Side-Grasping Teeth	8 in 203 mm
07-1025	Side-Grasping Teeth	10 in 254 mm
07-1030	Side-Grasping Teeth	12 in 305 mm
30-4200	Tip Width 2.2 mm Parallel Multiple Teeth	6 1/4 in 159 mm
30-4201	Tip Width 3.1 mm Parallel Multiple Teeth	8 in 203 mm



### Cartilage & Meniscus Forceps

CODE	DESCRIPTION	LENGTH
35-2021	Forceps	



## Forceps (Tissue)

### Castaneda Vascular Forceps

Titanium

CODE	DESCRIPTION	LENGTH	
30-8500	Tip Width 1.7 mm 1 x 2 Vascular Teeth Grooved with Cross Serrations	6 in	152 mm



### Classic Plus® General Surgery Dressing Forceps

Fine Tungsten Carbide Inserts

CODE	TIP WIDTH	LENGTH	
36-6010	1.8 mm Tip,	6 in	152 mm



### Coller Forceps

CODE	DESCRIPTION	LENGTH	
30-4035	Curved	6¼ in	159 mm



### Cooley Vascular Tissue Forceps

CODE	TIP WIDTH	LENGTH	
37-4028	1.0 mm, Cross-Serrated Jaws	8 in	203 mm



## Forceps (Tissue)

### Cushing Tissue Forceps

CODE	DESCRIPTION	LENGTH
32-520	Straight, Tungsten Carbide Inserts, Dissector Handle End	7 in 178 mm
36-6005	Straight 1.4 mm, Tip Tungsten Carbide Inserts	7 in 178 mm
32-525	Bayonet, Tungsten Carbide Inserts, Dissector Handle End	7½ in 191 mm
36-6007	Bayonet, 1.4 mm Tip Tungsten Carbide Inserts	7¾ in 197 mm
30-1140	Tip Width 1.5 mm, 1 x 2 Teeth Serrated Handle	7 in 178 mm
30-1142	Tip Width 1.7 mm, 1 x 2 Teeth Gutsch Handle	7 in 178 mm
30-1143	Tip Width 1.3 mm, 1 x 2 Teeth Gutsch Handle, Fine Tip	7 in 178 mm
30-1145	Tip Width 1.6 mm, 1 x 2 Teeth	7¾ in 197 mm



30-1140

### Cushing-Brown Bayonet Tissue Forceps

CODE	DESCRIPTION	LENGTH
07-2879	Tissue Forceps	7½ in 191 mm

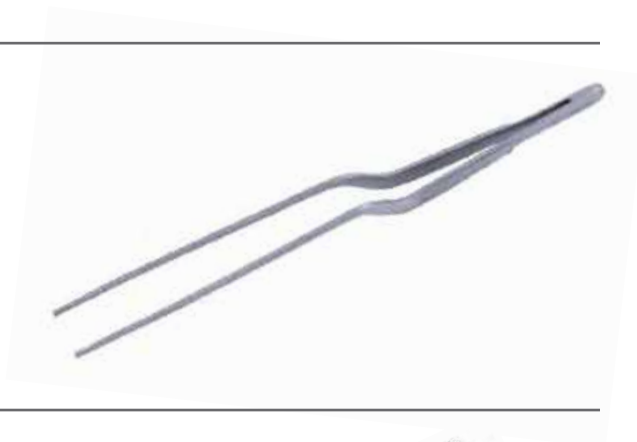

### D&y Scalp Forceps

Curved on One Side, Bright Finish

CODE	TEETH	LENGTH
32-4160	1 x 2 Serrated	5½ in 140 mm
32-4161	1 x 2 Teeth	5½ in 140 mm



32-4161

## Forceps (Tissue)

### DeBakey-Collier Tissue Forceps

CODE	DESCRIPTION	LENGTH
32-3549	Angled, Serrated	14 in 356 mm



### DeBakey Needle Pulling Tissue Forceps

DeBakey Teeth, Tungsten Carbide Inserts Behind Teeth

CODE	DESCRIPTION	LENGTH
32-559	1.5 mm Tip	7 <sup>3</sup> / <sub>8</sub> in 187 mm



### DeBakey Tissue Forceps

DeBakey Teeth, Tungsten Carbide Inserts Behind Teeth

CODE	TIP	LENGTH
32-564	1.5 mm	6 in 152 mm
32-565	1.5 mm	8 <sup>1</sup> / <sub>4</sub> in 210 mm
32-566	1.5 mm	9 <sup>5</sup> / <sub>8</sub> in 244 mm
32-560	2.0 mm	6 in 152 mm
32-561	3.0 mm	7 <sup>7</sup> / <sub>8</sub> in 200 mm
32-562	3.0 mm	9 <sup>1</sup> / <sub>2</sub> in 241 mm
32-563	3.0 mm	12 in 305 mm



## Forceps (Tissue)

### Delicate Right Angle Forceps

CODE	DESCRIPTION	LENGTH
54-7275	Angled, Delicate Jaws, 90°	5¼ in 133 mm
54-7277	Angled, Delicate Jaws, 90°	7¼ in 184 mm



### D'Errico Bayonet Tissue Forceps

Bayonet Shape

CODE	TIP WIDTH	TEETH	LENGTH
30-1201	2.4 mm	1x2	8¾ in 222 mm



### D'Errico Hypophyseal Forceps

Bayonet Shape

CODE	CUP I.D.	WORKING DISTANCE	LENGTH
30-1204	¼ in 6.0 mm	3½ in 89 mm	8⅝ in 219 mm



### Duval Lung Forceps

CODE	JAW WIDTH	LENGTH
30-8095	1 in 25 mm	7¾ in 197 mm

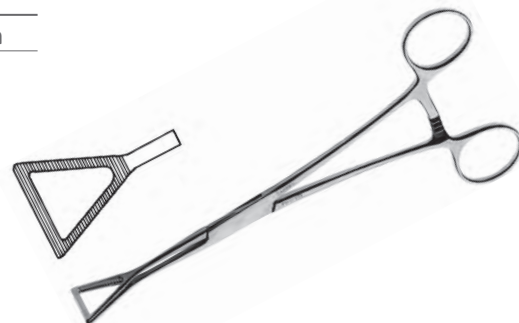

## Forceps (Tissue)

### Duval Tissue Forceps

Triangular Jaws, Tungsten Carbide Inserts

CODE	JAW WIDTH	LENGTH
36-6055	$\frac{3}{8}$ in 10 mm	$8\frac{1}{4}$ in 210 mm



### Duval-Collins Tissue Grasping Forceps

Triangular Jaw

CODE	JAW WIDTH	LENGTH
17-3615	15 mm	$7\frac{1}{2}$ in 191 mm
17-3665	15 mm	9 in 229 mm
17-3620	20 mm	$7\frac{1}{2}$ in 191 mm
17-3650	20 mm	9 in 229 mm
17-3671	25 mm	12 in 305 mm
17-3670	29 mm	9 in 229 mm



### Evans Tissue Forceps

CODE	DESCRIPTION	LENGTH
32-550	Tungsten Carbide Inserts Dissector Handle End	10 in 254 mm



## Forceps (Tissue)

### Ewald-Hudson Tissue Forceps

CODE	TIP WIDTH	TEETH	LENGTH
30-4216	1.6 mm	1x2	5 in 127 mm



### Ferris Smith Tissue Forceps

CODE	TIP WIDTH	TEETH	LENGTH
06-8792		1x2 Teeth	6 $\frac{7}{8}$ in 175 mm
30-1132	3.9 mm	2x3 Teeth	6 $\frac{3}{4}$ in 171 mm
06-8793		2x3 Teeth	6 $\frac{7}{8}$ in 175 mm

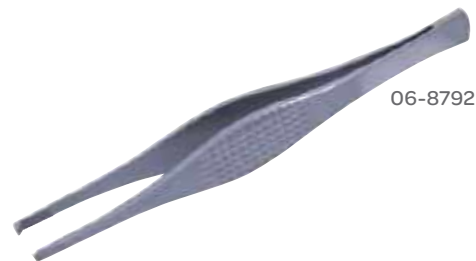

06-8792

### Forceps Allis Willauer

#### Bariatric Forceps

CODE	TEETH	LENGTH
32-3547	3x3 Teeth	14 in 356 mm



### Gemini Classic® Delicate Clamp

CODE	DESCRIPTION	LENGTH
30-4492	80° Angle	7 $\frac{1}{4}$ in 184 mm



## Forceps (Tissue)

### Gemini Mixer Forceps

CODE	DESCRIPTION	LENGTH
54-7262	Curved	14 in 356 mm
54-7255	Right Angle 90°, Delicate Jaws	5½ in 140 mm
54-7256	Right Angle 90°, Delicate Jaws	7¼ in 184 mm
54-7257	Right Angle 90°, Delicate Jaws	8¼ in 210 mm
54-7258	Right Angle 90°, Delicate Jaws	9 in 229 mm
54-7259	Right Angle, Delicate Jaws	11¼ in 286 mm
54-7266	Right Angle 90°	16 in 406 mm



54-7262

### Gemini Tissue Forceps

CODE	DESCRIPTION	LENGTH
32-3546	Serrated Tip	14 in 356 mm



### Gerald Tissue Forceps

CODE	DESCRIPTION	LENGTH
55-9001	1 x 2 Teeth	7 in 178 mm
32-568	1 x 2 Teeth, Tungsten Carbide Inserts	7 in 178 mm
32-567	1.0 mm Tips, Tungsten Carbide Inserts	9¼ in 235 mm
55-9000	Serrated	7 in 178 mm
55-9004	Serrated	9½ in 241 mm
55-9006	Serrated	14 in 356 mm



55-9000

55-9001



## Forceps (Tissue)

### Gerald Tissue Forceps

Tungsten Carbide Inserts

CODE	DESCRIPTION	LENGTH
32-570	1.0 mm Tips	7 in 178 mm
32-3531	1.0 mm Tips	7 in 178 mm
32-575	1.0 mm Tips	10 in 254 mm
32-3532	1.0 mm Tips	10 in 254 mm
32-576	1 x 2 Teeth	10 in 254 mm



### Gerald Tissue Forceps

CODE	DESCRIPTION	LENGTH
55-9048	Cross Serrations	7 ¾ in 197 mm



### Gerald Bayonet Tissue Forceps

1 x 2 Teeth

CODE	DESCRIPTION	LENGTH
30-1213	Tip Width 1.3 mm Working Distance: 3 ½ in (89 mm)	7 ½ in 191 mm



## Forceps (Tissue)

### Gerald Tissue Forceps

Straight

CODE	TIP WIDTH	TEETH	LENGTH
30-1210	1.3 mm	1x2	7 in 178 mm



### Gillies Tissue Forceps

CODE	TEETH	LENGTH
06-4085	1x2 Teeth	6 in 152 mm

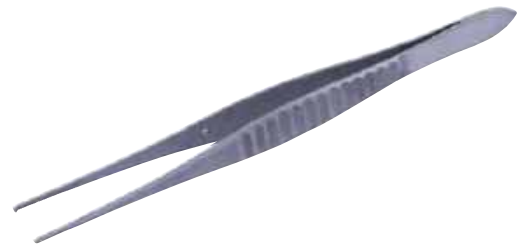

### Gorney Adson Forceps

CODE	TEETH	LENGTH
32-505	1x2 Teeth, Diamond-Dusted	4 3/4 in 121 mm



### Harrington-Mixer Forceps

Right-Angled Longitudinal Serrations with Cross-Serrated Tips

CODE	DESCRIPTION	LENGTH
30-8051	Thoracic Clamp	12 1/4 in 311 mm



## Forceps (Tissue)

### Heaney Tissue Forceps

CODE	DESCRIPTION	LENGTH
06-8798	2 x 3 Teeth, Cross-Serrated	5½ in 140 mm



### Hoehn Bayonet Tissue Forceps

Guthsch Handle

CODE	DESCRIPTION	LENGTH
30-1166	1 x 2 Teeth, Tip Width 2.1 mm Working Distance: 3 in (76 mm)	7¾ in 197 mm

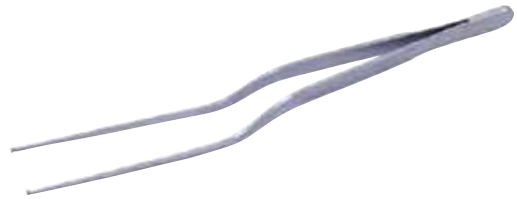

### Hoehn Scalp Hemostatic Forceps

CODE	DESCRIPTION	LENGTH
30-1115	Curved on Side, Serrated	5⅝ in 137 mm

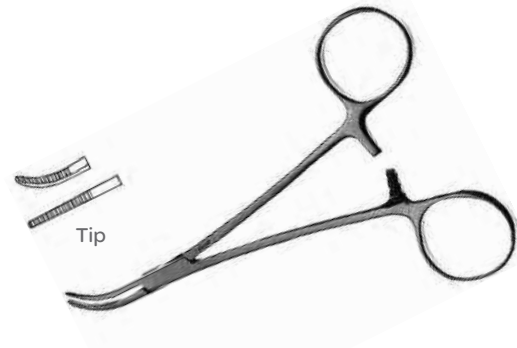

### Hudson Forceps

CODE	DESCRIPTION	LENGTH
06-2005	1 x 2 Teeth	4¾ in 121 mm



## Forceps (Tissue)

### Iowa Membrane Puncturing Forceps

CODE	DESCRIPTION	LENGTH
53-1226	5 x 6 Teeth, S-Shaped	10 ¼ in 260 mm



### Iris Tissue Forceps

1 x 2 Teeth

CODE	TIP WIDTH	LENGTH
30-6530	0.5 mm, Straight	4 in 108 mm
30-6532	0.5 mm, Curved	4 in 108 mm



30-6530

### Jewelers Forceps

CODE	DESCRIPTION	LENGTH
30-6712	#3, Extra Fine Point	4 ¾ in 121 mm
30-6713	#3C, Extra Fine Point	4 ⅝ in 109 mm
30-6714	#4, Extra Fine Point	4 ¼ in 108 mm
30-6715	#5, Extra Fine Point	4 ⅝ in 109 mm

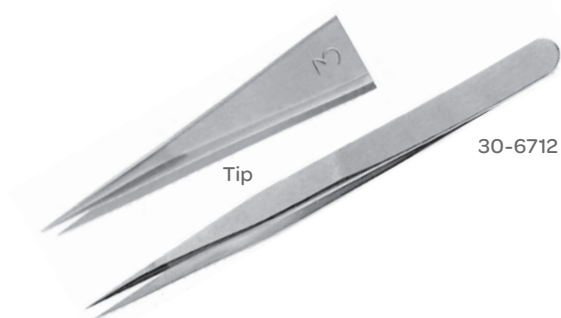

Tip

30-6712

### Johns Hopkins Gallbladder Forceps

CODE	DESCRIPTION	LENGTH
30-4297	Curved	8 in 203 mm



## Forceps (Tissue)

### Judd-Allis Tissue Forceps

CODE	DESCRIPTION	TEETH	LENGTH
50-0665	Narrow Jaws	3 x 4	6 in 152 mm
50-0670	Narrow Jaws	3 x 4	7½ in 191 mm

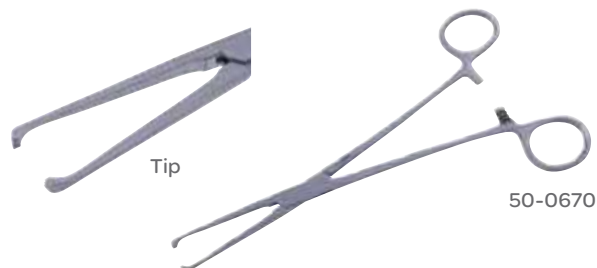

### Lahey Hemostatic Forceps

Full Serrations

CODE	DESCRIPTION	LENGTH
30-4020	Straight	5½ in 140 mm
30-4021	Curved	5¾ in 146 mm



### Lahey Gallbladder Duct Forceps Cross

CODE	DESCRIPTION	LENGTH
30-4500	Longitudinal Serrations	7½ in 191 mm
30-4502	Longitudinal Serrations	8¾ in 222 mm
30-4501	Horizontal Serrations	7½ in 191 mm



### Lawrence Forceps

CODE	DESCRIPTION	LENGTH
54-5006	Jaws Strongly Curved	7¼ in 184 mm
54-5007	Jaws Strongly Curved	11 in 279 mm



## Forceps (Tissue)

### Lockwood-Allis Tissue Forceps

CODE	TIP WIDTH	TEETH	LENGTH
50-0616		4x5	6 $\frac{1}{8}$ in 156 mm
30-4535	$\frac{3}{16}$ in 5.0 mm	5x6	6 in 152 mm



50-0616

### Martin Tissue Forceps

CODE	DESCRIPTION	LENGTH
07-5016	7x8 Teeth	8 in 203 mm
30-4230	6.0 mm Tip	6 in 152 mm
30-4231	6.0 mm Tip	7 in 178 mm



30-4231

### Mayo-Russian Tissue Forceps

CODE	DESCRIPTION	TIP WIDTH	LENGTH
30-8112	Fenestrated Jaws	6.0 mm	9 in 229 mm



### Meeker Forceps

CODE	DESCRIPTION	LENGTH
54-5005	Angled 90°	7 in 178 mm
54-7260	Angled 90°	10 $\frac{3}{4}$ in 273 mm



54-5005

## Forceps (Tissue)

### Meeker Deep Surgery Forceps

CODE	DESCRIPTION	LENGTH
30-4701	Right Angle	10 <sup>3</sup> / <sub>4</sub> in 273 mm

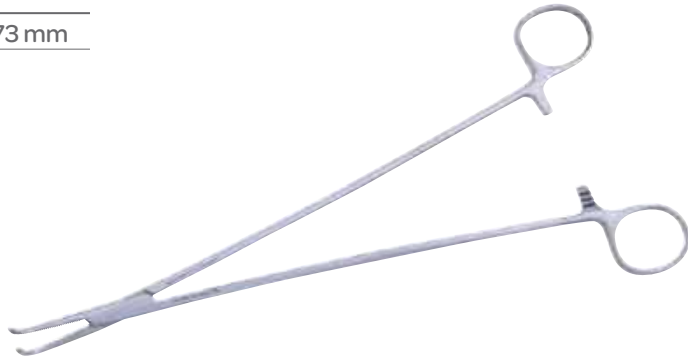

### Micro Forceps

CODE	DESCRIPTION	DIAMETER	TIP	LENGTH
78-0045	Straight, Flat Handle	9.0 mm	0.3 mm	4 <sup>1</sup> / <sub>4</sub> in 108 mm
78-0070	Straight, Flat Handle	9.0 mm	0.4 mm	4 <sup>1</sup> / <sub>4</sub> in 108 mm
78-0060	Straight, Flat Handle	7.0 mm	0.3 mm	5 <sup>1</sup> / <sub>4</sub> in 133 mm
78-0055	Straight, Flat Handle	9.0 mm	0.3 mm	5 <sup>1</sup> / <sub>4</sub> in 133 mm
78-0075	Straight, Flat Handle	9.0 mm	0.3 mm Pierce	5 <sup>1</sup> / <sub>4</sub> in 133 mm
78-0050	Straight, Flat Handle	9.0 mm	0.3 mm w/Platform	5 <sup>1</sup> / <sub>2</sub> in 140 mm
78-0047	Straight, Round Handle	8.0 mm	0.3 mm	5 <sup>1</sup> / <sub>2</sub> in 140 mm
78-0106	Straight, Counterbalance Handle	8.0 mm	0.6 mm w/Platform	6 in 152 mm
78-0086	Straight			4 <sup>3</sup> / <sub>4</sub> in 121 mm
78-0025	Round Handle	8.0 mm	0.3 mm	
78-0012	Flat Handle	9.0 mm	0.3 mm	4 <sup>3</sup> / <sub>4</sub> in 121 mm
78-0065	Angled 45°, Flat Handle	9.0 mm	0.3 mm	4 <sup>1</sup> / <sub>4</sub> in 108 mm
78-0040	Angled 45°, Flat Handle	9.0 mm	0.3 mm	5 <sup>1</sup> / <sub>4</sub> in 133 mm
78-0142			0.3 mm w/Platform	7 in 178 mm



78-0040

## Forceps (Tissue)

### Adson (Micro) Tissue Forceps

CODE	DESCRIPTION	LENGTH
06-2312	1x2 Teeth	4 <sup>3</sup> / <sub>4</sub> in 121 mm
06-2315	1x2 Teeth	6 in 152 mm

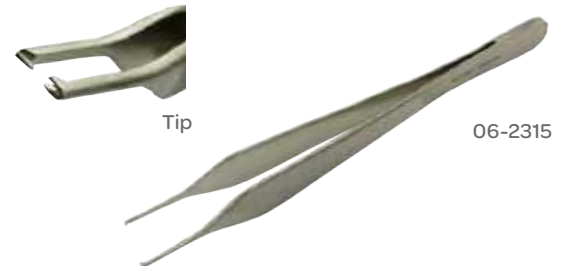

### Adson (Micro) Tissue Forceps

CODE	DESCRIPTION	LENGTH
06-2212	Serrated	4 <sup>3</sup> / <sub>4</sub> in 121 mm
06-2215	Serrated	6 in 152 mm



### Mixer Forceps

CODE	DESCRIPTION	LENGTH
17-0723	Right Angled, Delicate	9 <sup>1</sup> / <sub>2</sub> in 241 mm



### Mixer Right-Angled Forceps

CODE	DESCRIPTION	LENGTH
17-0820	90°	12 in 305 mm
17-0830	90°	14 <sup>1</sup> / <sub>2</sub> in 368 mm
17-0840	90°	16 in 406 mm
17-0845	90°	18 in 458 mm
17-1219	Cross-Serrated Tips, Longitudinal Serrations	7 <sup>1</sup> / <sub>2</sub> in 191 mm
17-1222	Cross-Serrated Tips, Longitudinal Serrations	8 <sup>1</sup> / <sub>2</sub> in 216 mm
17-1225	Cross-Serrated Tips, Longitudinal Serrations	10 in 254 mm
17-1228	Cross-Serrated Tips, Longitudinal Serrations	12 <sup>3</sup> / <sub>8</sub> in 314 mm

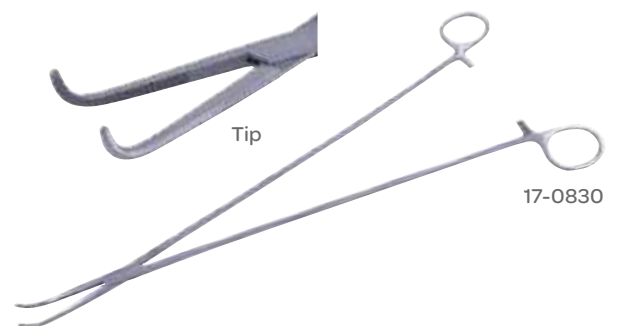



## Forceps (Tissue)

### Mixer Classic® Delicate Hemostatic Forceps

CODE	DESCRIPTION	LENGTH
30-4485	Right Angle	5½ in 140 mm



### Mixer Gall Bladder Forceps

CODE	DESCRIPTION	LENGTH
30-4080	Curved	6¼ in 159 mm
30-4081	Curved	7¼ in 184 mm



30-4080

### Needle Forceps

Micro, Tungsten Carbide Inserts

CODE	DESCRIPTION	LENGTH
32-532	1 x 2 Teeth with Serrations	6¼ in 159 mm

### Nelson Tissue Forceps

CODE	DESCRIPTION	LENGTH
07-1915	6 x 7 Teeth	6 in 152 mm



## Forceps (Tissue)

### Nugent Utility Forceps

Smooth, Angled Tip

CODE	TIP WIDTH	LENGTH
30-6695	0.5 mm	4 in 102 mm



### Opti-Length® Forceps

General Surgery

CODE	TIP WIDTH	LENGTH
67-7584	2.0 mm	10 in 254mm
67-7586	2.0 mm	12 in 305 mm
67-7585	3.0 mm	10 in 254 mm
67-7587	3.0 mm	12 in 305 mm

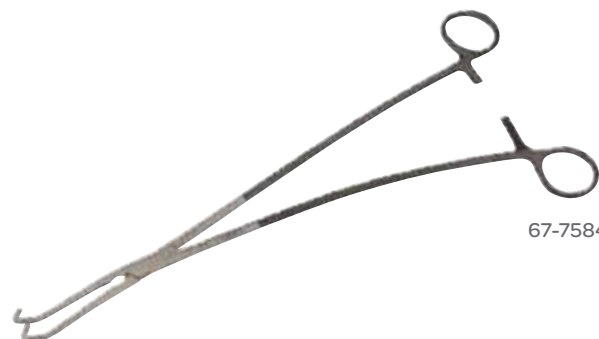

67-7584

### Penfield Watchmaker Forceps

CODE	TIP WIDTH	LENGTH
06-1966	0.9 mm	7 in 178 mm
30-1194	0.9 mm	7 in 178 mm



30-1194

### Pennington Forceps

Triangular Jaw

CODE	JAW WIDTH	LENGTH
17-3415	12 mm	6 in 152 mm
17-3420	12 mm	8 ½ in 216 mm



17-3415

## Forceps (Tissue)

### Potts-Smith Tissue Forceps

CODE	DESCRIPTION	LENGTH
32-526	Tungsten Carbide Inserts	7¼ in 184 mm
32-527	Tungsten Carbide Inserts	8 in 203 mm
32-530	Tungsten Carbide Inserts	9 in 229 mm
32-531	Tungsten Carbide Inserts	10 in 254 mm



32-526

### Potts-Smith Tissue Forceps

CODE	DESCRIPTION	LENGTH
06-4818	1x2 Teeth	7½ in 181 mm
06-4820	1x2 Teeth	8½ in 216 mm
06-4825	1x2 Teeth	10 in 254 mm
06-4835	1x2 Teeth	12 in 305 mm
06-4838	1x2 Teeth	14 in 356 mm



06-4818

### Potts-Smith Tissue Forceps

CODE	DESCRIPTION	TIP WIDTH	LENGTH
30-8023	1x2 Teeth	1.7 mm	7¼ in 184 mm
30-8024	1x2 Teeth	1.7 mm	8¼ in 210 mm

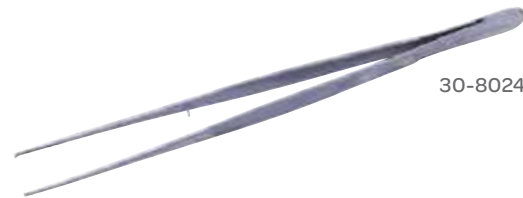

30-8024

### Potts-Smith Tissue Forceps

CODE	DESCRIPTION	TIP WIDTH	LENGTH
30-8123	1x2 Teeth	1.8 mm	12 in 305 mm
36-6015	Tungsten Carbide Inserts	1.5 mm	9 in 229 mm

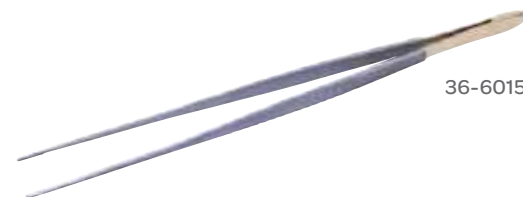

36-6015

### Potts-Smith Tissue Forceps

T-Shaped

CODE	TIP WIDTH	LENGTH
30-4095	⅝ in 8.0 mm	6 in 152 mm



## Forceps (Tissue)

### Raimondi Scalp Forceps

Infant Scalp

CODE	DESCRIPTION	LENGTH
30-1360	1x2 Teeth, Curved on Side	5 in 127 mm



### Resano Titanium Vascular Tissue Forceps

CODE	DESCRIPTION	LENGTH
55-2050T	Atraumatic Teeth	9 in 229 mm



### Rhoton® Dural Forceps

CODE	DESCRIPTION	TIP WIDTH	LENGTH
80-1731	1x2 Teeth, Titanium	1.0 mm	7 in 178 mm



### Rhoton® Forceps

Titanium

CODE	DESCRIPTION	TIP WIDTH	LENGTH
80-1700	Straight	0.3 mm, Extra Fine	7 in 178 mm
80-1701	Straight	0.7 mm, Fine	7 in 178 mm
80-1702	Bayonet	0.5 mm, Fine	8 ½ in 216 mm
80-1703	Bayonet	1.0 mm, Regular	8 ½ in 216 mm



80-1702

## Forceps (Tissue)

### Rhoton® Tumor Forceps

Bayonet, Tip Width 4.0 mm, Serrated Ring

CODE	DESCRIPTION	LENGTH
80-1736	Working Distance 3½ in (89 mm) Titanium	8½ in 216 mm
80-1748	Working Distance 3¾ in (95 mm)	9½ in 241 mm



80-1736

### Russian Tissue Forceps

CODE	DESCRIPTION	TIP WIDTH	LENGTH
07-1515	Side Grasping Teeth	6 in	152 mm
07-1520	Side Grasping Teeth	8 in	203 mm
07-1525	Side Grasping Teeth	10¼ in	260 mm
07-1530	Side Grasping Teeth	14 in	356 mm
30-4220		6.0 mm	6 in 152 mm
30-4221		7.0 mm	8 in 203 mm
30-4222		7.2 mm	10 in 254 mm



30-4220

### Sawtell Forceps

CODE	DESCRIPTION	LENGTH
17-2155	Full Curve, One Open Ring	7½ in 191 mm
17-2156	Full Curve, Closed Rings	7¼ in 184 mm

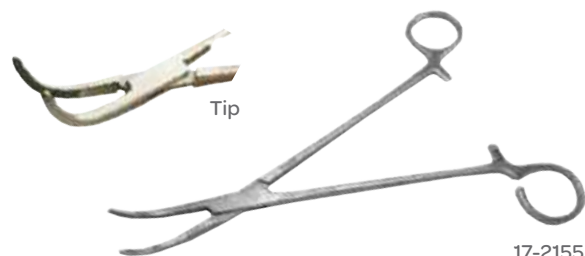

17-2155

### Schmidt Forceps

CODE	DESCRIPTION	LENGTH
17-2150	Light Curve, One Open Ring	7½ in 191 mm
17-2151	Light Curve, Closed Rings	7½ in 191 mm
17-2157	Closed Ring	10 in 254 mm

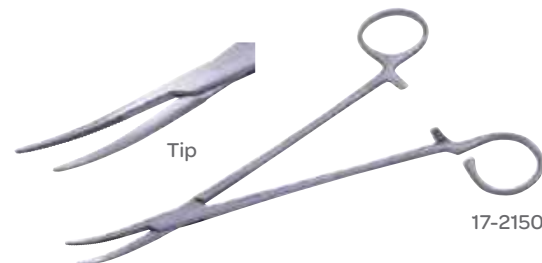

17-2150

## Forceps (Tissue)

### Seizing Forceps

CODE	DESCRIPTION
14-4805	Ext Forceps Wire

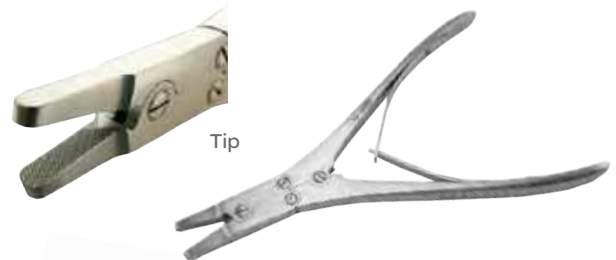

### Selman Tissue Forceps

CODE	DESCRIPTION	LENGTH
07-1406	Round Jaws with Teeth	6¼ in 159 mm
07-1410	Round Jaws with Teeth	8¼ in 210 mm



### Semken Tissue Forceps

CODE	TIP WIDTH	LENGTH
30-1170	1.3 mm	5 in 127 mm

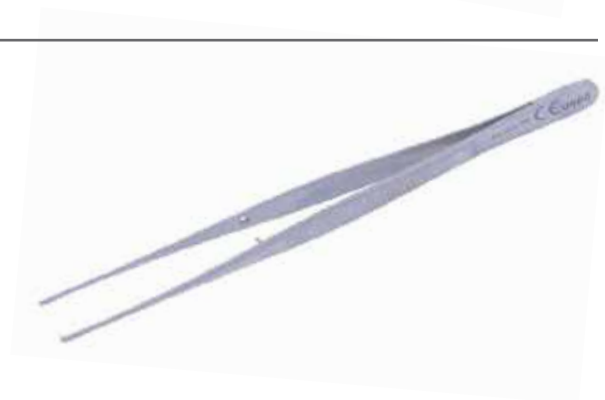

### Semkin Forceps

CODE	DESCRIPTION	LENGTH
06-3115	1x2 Teeth, Straight	6 in 152 mm



## Forceps (Tissue)

### Singley Intestinal Forceps

CODE	DESCRIPTION	LENGTH
30-4517	Serrated Fenestrated Jaws	9 in 229 mm

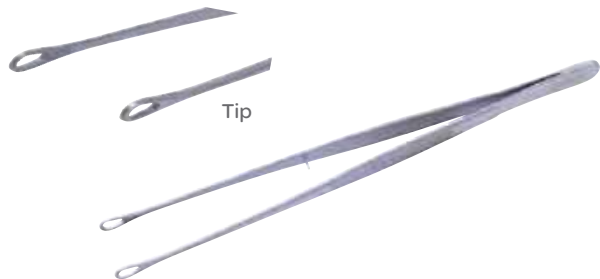

### Skinner Needle Forceps

CODE	DESCRIPTION	LENGTH
32-519	1 x 2 Teeth, Tungsten Carbide Inserts	9 in 229 mm
32-521	1 x 2 Teeth, Tungsten Carbide Inserts	9 in 229 mm

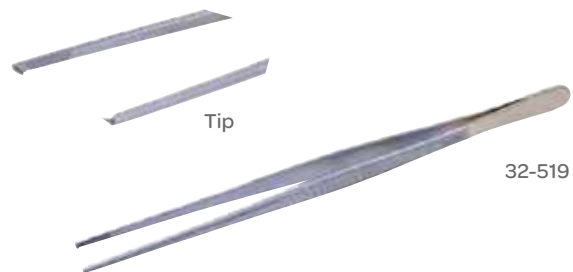

### Spetzler Neuro-Vascular Forceps

Bayonet, Titanium, Working Distance 4 in (102 mm)

CODE	DESCRIPTION	TIP WIDTH	LENGTH
80-1905	Straight Tip	0.7 mm	9½ in 241 mm
80-1906	30° Angled Tip	0.7 mm	9½ in 241 mm



### Stern-Castroviejo Forceps

CODE	DESCRIPTION	LENGTH
60-1633	Straight, 0.5 mm Teeth with Platform with Lock	4½ in 105 mm



## Forceps (Tissue)

### Tebbetts-Brown Forceps

CODE	DESCRIPTION	LENGTH
32-508	Tungsten Carbide Inserts	4 <sup>3</sup> / <sub>4</sub> in 121 mm



### Thoms-Allis Tissue Forceps

CODE	DESCRIPTION	LENGTH
50-0520	6 x 7 Teeth	8 in 203 mm
30-4554	Tip Width <sup>1</sup> / <sub>4</sub> in (6.0 mm)	8 <sup>1</sup> / <sub>2</sub> in 216 mm

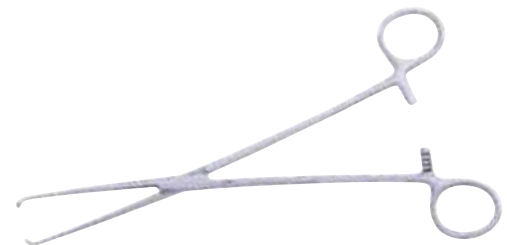

30-4554

### Thoracic Forceps

CODE	DESCRIPTION	LENGTH
30-8082	Delicately Curved	9 <sup>1</sup> / <sub>2</sub> in 241 mm



### Tickner Tissue Forceps

CODE	DESCRIPTION	TIP WIDTH	LENGTH
36-6030	Tungsten Carbide Inserts	1.8 mm	6 in 152 mm



### Tissue Forceps

CODE	DESCRIPTION	LENGTH
32-3557	Non-Slip, Round Tip	10 in 254 mm





# Forceps (Tissue)

## Tissue Forceps

CODE	DESCRIPTION	LENGTH
06-1125	3 x 4 Teeth, Standard Pattern	10 in 254 mm

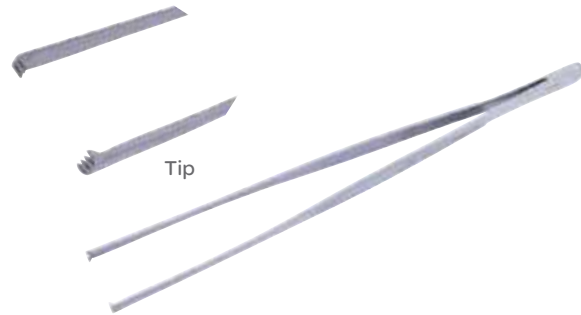

## Tissue Forceps

CODE	DESCRIPTION	LENGTH
06-5614	4 x 5 Teeth, Stille-Type	5 in 127 mm



## Tissue Forceps

Standard Pattern

CODE	DESCRIPTION	LENGTH
06-0511	1 x 2 Teeth	4 3/4 in 121 mm
06-0513	1 x 2 Teeth	5 in 127 mm
06-0514	1 x 2 Teeth	5 1/2 in 140 mm
06-0515	1 x 2 Teeth	6 in 152 mm
06-0518	1 x 2 Teeth	7 in 178 mm
06-0520	1 x 2 Teeth	8 in 203 mm
06-0525	1 x 2 Teeth	10 in 254 mm
06-0530	1 x 2 Teeth	12 in 305 mm
06-0535	1 x 2 Teeth	14 in 356 mm
06-0545	1 x 2 Teeth	18 in 458 mm
06-1013	2 x 3 Teeth	5 1/8 in 130 mm
06-1014	2 x 3 Teeth	5 3/4 in 146 mm
06-1016	2 x 3 Teeth	6 1/4 in 159 mm
06-1020	2 x 3 Teeth	8 in 203 mm
06-1113	2 x 3 Teeth	5 1/8 in 130 mm
06-1114	2 x 3 Teeth	5 3/4 in 146 mm
06-1116	2 x 3 Teeth	6 1/4 in 159 mm
06-1120	2 x 3 Teeth	8 in 203 mm

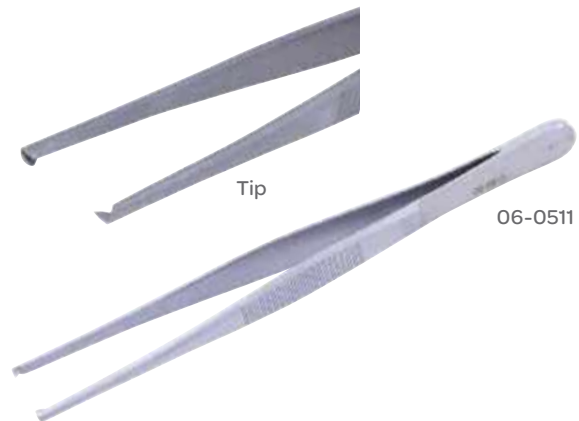

## Forceps (Tissue)

### Tissue Forceps

CODE	DESCRIPTION	LENGTH
30-4161	2 x 3 Teeth, 3.9 mm Tip	5½ in 140 mm

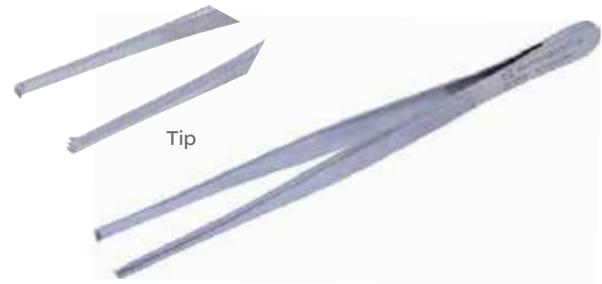

### Tissue Forceps

Tungsten Carbide Inserts

CODE	DESCRIPTION	LENGTH
32-514	1 x 2 Teeth	5¾ in 146 mm
32-516	1 x 2 Teeth	6¼ in 159 mm



### Tissue Forceps

CODE	TIP WIDTH	LENGTH
67-7582	2.0 mm	8 in 203 mm



### Tissue Forceps

1 x 2 Teeth

CODE	TIP WIDTH	LENGTH
30-4151	2.3 mm	5 in 127 mm
30-4152	2.3 mm	5½ in 140 mm
30-4153	2.3 mm	6 in 152 mm
30-4155	3.0 mm	8 in 203 mm
30-4156	3.1 mm	10 in 254 mm
30-4157	3.9 mm	12 in 305 mm

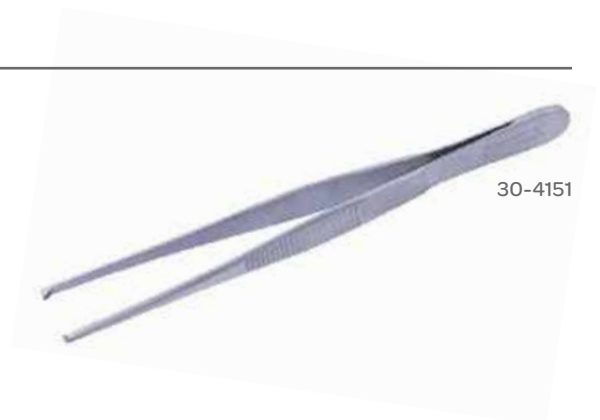

## Forceps (Tissue)

### Tissue Forceps MagnaFree®

Non-Magnetic, Titanium

CODE	DESCRIPTION	TIP	LENGTH
65-2420	2x3 teeth	3.9 mm	5½ in 140 mm



### Tuttle (Singley) Tissue Forceps

CODE	DESCRIPTION	LENGTH
07-1718	Tissue Forceps	7½ in 181 mm
07-1723	Tissue Forceps	9 in 229 mm
07-1724	Tissue Forceps	14 in 356 mm
07-1728	Tissue Forceps	18 in 458 mm

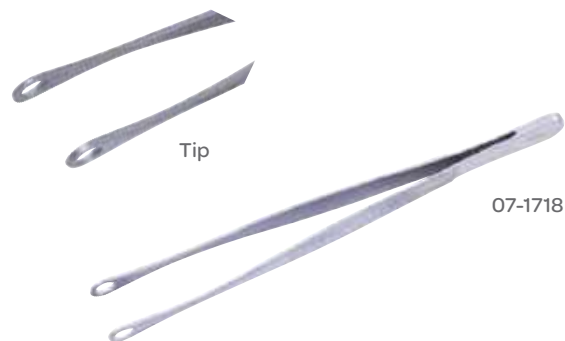

### Varco Gall Bladder Forceps Slight Curve

CODE	DESCRIPTION	LENGTH
30-4652	Slightly Curved	7½ in 191 mm

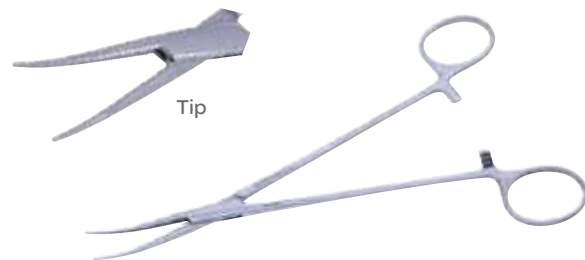

### Von Graefe Fixation Forceps

CODE	DESCRIPTION	TIP WIDTH	LENGTH
30-6585	No Teeth	2.0 mm	4¾ in 121 mm



## Forceps (Tissue)

### Wangensteen Tissue Forceps

CODE	DESCRIPTION	LENGTH
32-535	Serrated, Tungsten Carbide Inserts	9 in 229 mm

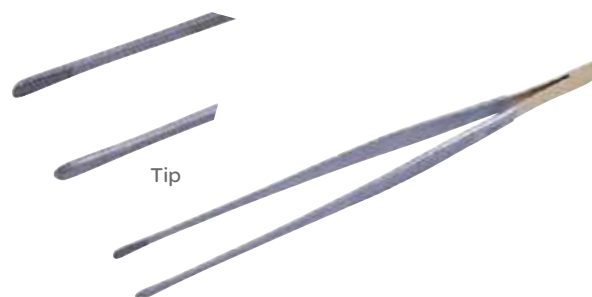

### Waugh Tissue Forceps

CODE	DESCRIPTION	TEETH	LENGTH
06-4215	Serrated		6 in 152 mm
06-4220	Serrated		8 in 203 mm
06-4315		1x2	6 in 152 mm



### Willauer-Allis Tissue Forceps

CODE	DESCRIPTION	LENGTH
30-8085	Curved	10 in 254 mm



### Williams Tissue Forceps

CODE	DESCRIPTION	LENGTH
50-0816	Straight	6½ in 165 mm

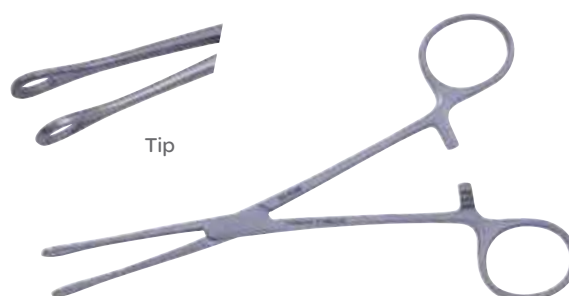

## Forceps (Tissue-Tying)

### Callison Tissue-Tying Forceps

Tying Platform

CODE	DESCRIPTION	LENGTH
06-2590	1 x 2 Teeth, 1.5 mm Teeth	4 7/8 in 124 mm



## Forceps (Titanium)

### Adson MagnaFree® Tissue Forceps

Titanium, Non-Magnetic

CODE	DESCRIPTION	LENGTH
65-2413	1 x 2 Teeth	5 in 127 mm



### Adson Titanium Dressing Forceps

CODE	DESCRIPTION	LENGTH
06-2012T	Serrated Jaws	4 3/4 in 121 mm
06-2112T	1 x 2 Teeth	4 3/4 in 121 mm

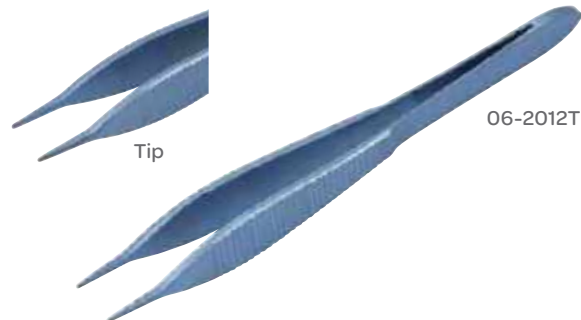

### DeBakey Titanium Vascular Tissue Forceps

DeBakey Teeth, Titanium

CODE	DESCRIPTION	LENGTH
55-2004T	1.0 mm Tips	6 in 152 mm
55-2005T	1.0 mm Tips	7 3/4 in 197 mm
55-2008T	2.0 mm Tips	7 3/4 in 197 mm
55-2009T	2.0 mm Tips	9 1/2 in 241 mm
55-2007T	2.0 mm Tips	6 in 152 mm

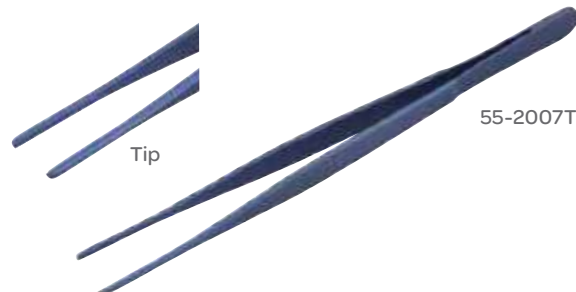

## Forceps (Titanium)

### Forceps

Straight, Titanium

CODE	DESCRIPTION	TIP WIDTH	LENGTH	
80-6631	Extra Fine Utility	0.3 mm	6 in	152 mm
80-6630	Extra Fine Tying Tip	0.7 mm	6 in	152 mm
80-6001	Ring Tip, Closing Pressure (Appx.) 50 Grams	1.0 mm	6 in	152 mm
80-6002	Ring Tip, Serrated, Closing Pressure (Appx.) 50 Grams	1.0 mm	6 in	152 mm



80-6630

### MagnaFree® Crile Forceps

Delicate

CODE	DESCRIPTION	LENGTH	
65-2418	Straight, Titanium	5½ in	140 mm
65-2419	Curved, Titanium	5½ in	140 mm



65-2418

### MagnaFree® Dressing Forceps

Non-Magnetic for Interventional MRI

CODE	DESCRIPTION	TIP	LENGTH	
65-2407	Serrated, Titanium	3.0 mm	10 in	254 mm



## Forceps

### MagnaFree® Sponge Forceps

CODE	DESCRIPTION	LENGTH
65-2415	Straight, Serrated Jaws, Titanium, Non Magnets	9½ in 241 mm

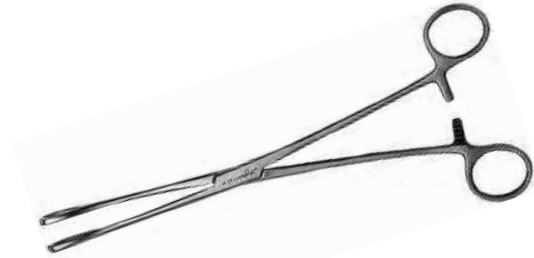

## Forceps (Tongue)

### Collin Tongue Forceps

CODE	DESCRIPTION	LENGTH
30-4330	Seizing Forceps	6½ in 165 mm



## Forceps (Tonsil)

### Schmidt Forceps

CODE	DESCRIPTION	LENGTH
17-2154	Full Curve, Closed Rings	14 in 356 mm

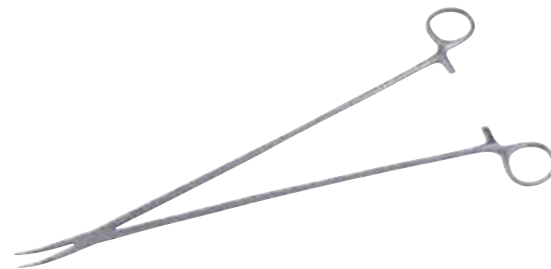

### White Tonsil Forceps

CODE	DESCRIPTION	LENGTH
30-7315	Seizing Forceps	7 in 178 mm



## Forceps (Tracheal Tenaculum)

### Jackson Tracheal Hook Tenaculum Forceps

CODE	DESCRIPTION	LENGTH
20-4014	1 Prong, Sharp	5 $\frac{3}{4}$ in 146 mm



## Forceps (Tying)

### Jaffe Tying Forceps

Smooth Tips, Very Delicate with Platform

CODE	DESCRIPTION	LENGTH
60-1608	Straight	4 in 102 mm
60-1609	Curved	4 in 102 mm



## Forceps (Uterine)

### Bozeman Uterine Dressing Forceps

CODE	DESCRIPTION	LENGTH
30-5561	Curved Shafts and Shanks	10 in 254 mm



### Jacobs Uterine Vulsellum Forceps

CODE	DESCRIPTION	LENGTH
30-5605	2 x 2 Teeth	8 in 203 mm





## Forceps (Uterine)

### Phaneuf Uterine Artery Forceps

CODE	DESCRIPTION	LENGTH
30-5536	1 x 2 Teeth, Angled	8 ¼ in 210 mm

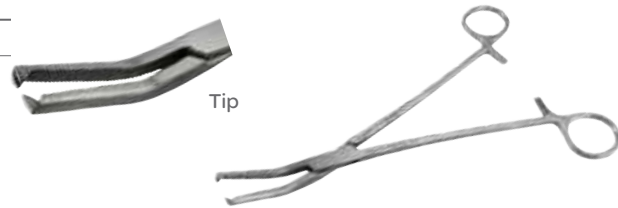

### Schroeder Uterine Tenaculum Forceps

CODE	DESCRIPTION	LENGTH
30-5580	1 x 1 Sharp Teeth, Straight	8 ¾ in 222 mm



### Schroeder Uterine Vulsellum Forceps

CODE	DESCRIPTION	LENGTH
30-5595	2 x 2 Sharp Teeth	9 in 229 mm



### Teale Uterine Vulsellum Forceps

CODE	DESCRIPTION	LENGTH
30-5615	4 x 5 Sharp Teeth, Curved on Side	10 ⅞ in 257 mm



## Forceps (Vascular)

### Cooley Vascular Forceps

CODE	DESCRIPTION	LENGTH	
55-2026	1.0 mm, Cross-Serrated Tip	8 in	203 mm
55-2027	1.0 mm, Cross-Serrated Tip	12 in	305 mm

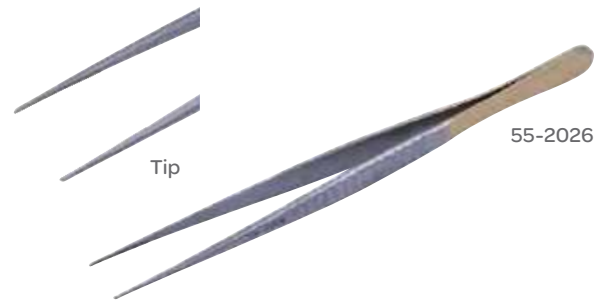

### Cooley Vascular Tissue Forceps

CODE	DESCRIPTION	LENGTH	
55-2022	Cooley Teeth	6 in	152 mm
55-2023	Cooley Teeth	8 in	203 mm
55-2024	Cooley Teeth	9½ in	241 mm

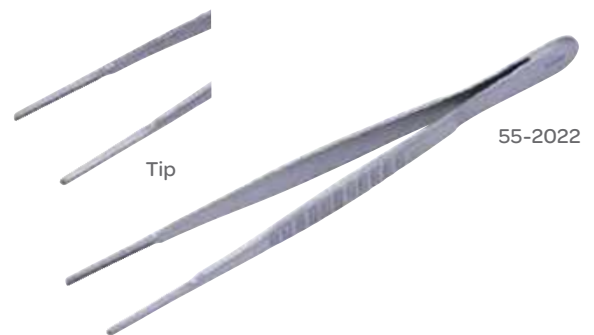

## Forceps (Vascular)



### Daicoff Vascular & Needle Pulling Forceps

Tungsten Carbide Inserts, Serration Length  $1\frac{1}{16}$  in (17 mm)

CODE	DESCRIPTION	TIP WIDTH	TOOTH LENGTH	LENGTH
30-8015	1 x 2 Vascular Teeth	2.0 mm	0.8 mm	7 $\frac{3}{4}$ in 197 mm

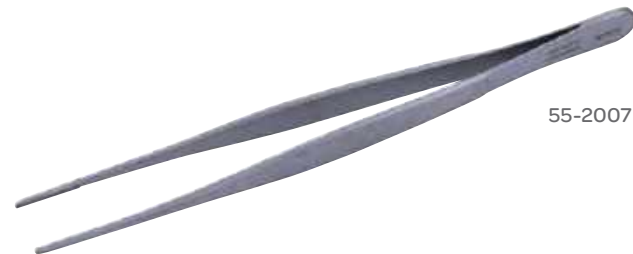

55-2007

### DeBakey Vascular Tissue Forceps

CODE	DESCRIPTION	TIP WIDTH	LENGTH
55-2000	Straight Tips	2.0 mm	7 in 178 mm
55-2007	Fluted Handle	2.0 mm	6 in 152 mm
55-2008	Fluted Handle	2.0 mm	7 $\frac{3}{4}$ in 197 mm
55-2009	Fluted Handle	2.0 mm	9 $\frac{1}{2}$ in 241 mm
55-2010	Fluted Handle	2.0 mm	12 in 305 mm
55-2030	Fluted Handle	2.0 mm	14 in 356 mm
55-2040	Fluted Handle	2.0 mm	16 in 406 mm
55-2015	Angled Tips	2.0 mm	7 $\frac{3}{4}$ in 197 mm
55-2016	Angled Tips	2.0 mm	9 $\frac{1}{2}$ in 241 mm
55-2017	Angled Tips	2.0 mm	11 $\frac{3}{4}$ in 298 mm
55-2018	Fluted Handle with Shoulders	3.0 mm	6 in 152 mm
55-2019	Fluted Handle with Shoulders	3.0 mm	7 $\frac{3}{4}$ in 197 mm
55-2020	Fluted Handle with Shoulders	3.0 mm	9 $\frac{1}{2}$ in 241 mm
55-2021	Fluted Handle with Shoulders	3.0 mm	12 in 305 mm
55-2065	Fluted Handle with Shoulders	3.0 mm	14 in 356 mm
55-2075	Fluted Handle with Shoulders	3.0 mm	16 in 406 mm

## Forceps (Vascular)

### DeBakey Vascular Tissue Forceps

CODE	TIP WIDTH	LENGTH
67-7801	2.0 mm	12 in 305 mm
67-7803	2.0 mm	14 in 356 mm



67-7801

### DeBakey Dietrich Vascular Tissue Forceps

DeBakey Teeth, Serrated Handle

CODE	TIP WIDTH	LENGTH
55-2004	1.0 mm	6 in 152 mm
55-2005	1.0 mm	7¾ in 197 mm
55-2006	1.0 mm	9½ in 241 mm

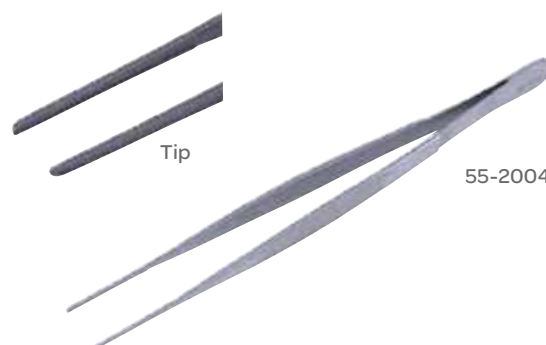

55-2004

### DeBakey Dietrich Vascular Tissue Forceps

CODE	DESCRIPTION	LENGTH
30-8131	Tip Tapers From 1.5–1.3 mm	6 in 152 mm
30-8132	Tips Taper From 1.5–1.3 mm	7¾ in 197 mm
30-8133	Tips Taper From 1.5–1.3 mm	9½ in 241 mm

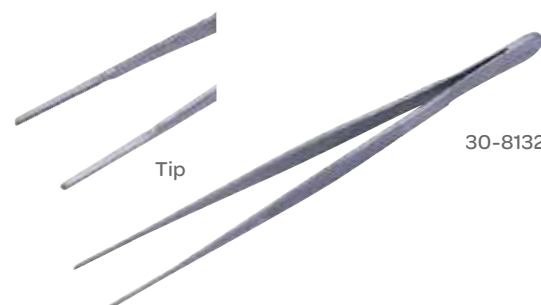

30-8132

### DeBakey Opti-Length® Forceps

CODE	TIP WIDTH	LENGTH
67-7800	1.5 mm	12 in 305 mm
67-7802	1.5 mm	14 in 356 mm



67-7800

## Forceps (Vascular)

### DeBakey Thoracic Tissue Forceps

CODE	DESCRIPTION	LENGTH
32-3550	Tissue Forceps	14 in 356 mm



### DeBakey Tissue Forceps

CODE	TIPS	LENGTH
37-1000	3.0 mm Tips	6 in 152 mm
37-1001	3.0 mm Tips	7 3/4 in 197 mm
37-1002	3.0 mm Tips	9 1/2 in 241 mm
37-1003	3.0 mm Tips	12 in 305 mm

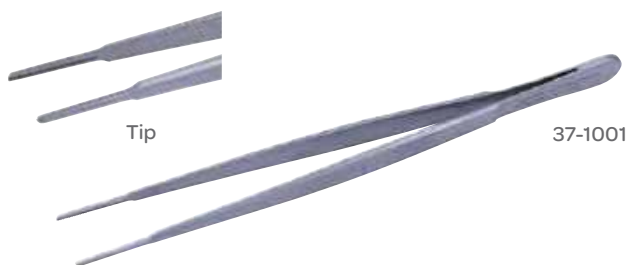

### DeBakey Vascular Forceps

CODE	DESCRIPTION	LENGTH
37-1010	2.0 mm Tips	6 in 152 mm
37-1011	2.0 mm Tips	7 3/4 in 197 mm
37-1012	2.0 mm Tips	9 1/2 in 241 mm
37-1013	2.0 mm Tips	12 in 305 mm



### DeBakey-Liddicoat Vascular Forceps

Straight, 1 x 2 Vascular Teeth, Titanium

CODE	TIP WIDTH	LENGTH
30-8400	1.8 mm	6 in 152 mm
30-8401	1.8 mm	6 in 152 mm
30-8402	1.8 mm	7 3/4 in 197 mm
30-8403	1.8 mm	7 3/4 in 197 mm
30-8404	1.8 mm	9 1/2 in 241 mm
30-8405	2.25 mm	9 1/2 in 241 mm

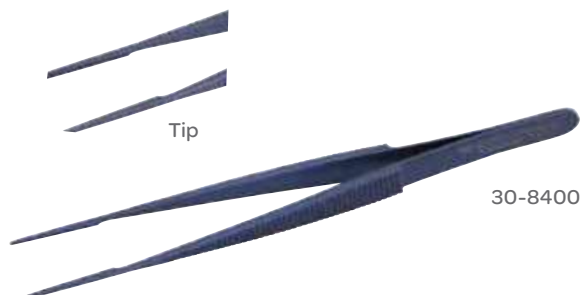

## Forceps (Vasectomy)

### Sanders Vasectomy Forceps

CODE	DESCRIPTION	LENGTH
51-8001	1x1 Prongs	6 $\frac{1}{8}$ in 156 mm



### Vasectomy No Scalpel Hemostatic Forceps

CODE	DESCRIPTION	LENGTH
51-8004	Circular Jaws	6 $\frac{1}{4}$ in 159 mm



## Goniometers (Finger Goniometer)

### Pollock Finger Goniometer

CODE	DESCRIPTION	LENGTH
44-3830	Finger Goniometer	6 in 152 mm



## Hammers

### Taylor Percussion Hammer

CODE	DESCRIPTION	LENGTH
88-4000	Percussion Hammer	8 in 203 mm



## Hooks (Double Hook)

### Fixation Double Hook

2 Prongs, Sharp

CODE	TIP WIDTH	LENGTH
60-1298	1.5 mm	5 1/8 in 130 mm
60-1299	2.0 mm	5 1/8 in 130 mm



### Freer Double Hook

CODE	TIP WIDTH	LENGTH
20-5202	3.0 mm, Sharp	6 in 152 mm



## Hooks (Double Hook)

### Joseph Nasal Double-Prong Hook

CODE	TIP WIDTH	LENGTH
38-6645	$\frac{1}{16}$ in 2.0 mm	6 $\frac{1}{4}$ in 159 mm
38-6646	$\frac{3}{16}$ in 5.0 mm	6 $\frac{1}{4}$ in 159 mm
38-6647	$\frac{1}{4}$ in 6.0 mm	6 $\frac{1}{4}$ in 159 mm
38-6648	$\frac{3}{8}$ in 10 mm	6 $\frac{1}{4}$ in 159 mm



38-6648

### Joseph Skin Hook

Sharp

CODE	TIP WIDTH	LENGTH
20-5002	$\frac{1}{16}$ in 2.0 mm	6 $\frac{1}{4}$ in 159 mm
20-5005	$\frac{3}{16}$ in 5.0 mm	6 $\frac{1}{4}$ in 159 mm
20-5007	$\frac{1}{4}$ in 6.0 mm	6 $\frac{1}{4}$ in 159 mm
20-5010	$\frac{3}{8}$ in 10 mm	6 $\frac{1}{4}$ in 159 mm



20-5002

### Meyerding Finger Hook-Retractor

With Skin Hook, Double Ended

CODE	DESCRIPTION	LENGTH
50-4485	Blade Width $\frac{3}{16}$ in (5.0 mm) Blade Depth $\frac{5}{8}$ in (16 mm) Hook Depth $\frac{3}{8}$ in (10 mm)	6 $\frac{1}{4}$ in 159 mm



### Smithwick Neck Hook-Dissector

Blunt, Double Ended

CODE	DESCRIPTION	LENGTH
38-1088	Tip Diameter (0.02 mm) Hook Length $\frac{7}{16}$ in (11 mm)	12 in 305 mm





## Hooks (Dura)

### Tracheal Hook

CODE	DESCRIPTION	LENGTH
20-6502	Double Prong, Blunt	6¼ in 159 mm



### Adson Dura Hook

CODE	DESCRIPTION	LENGTH
20-2722	1 Prong, Sharp	8 in 203 mm
20-2723	1 Prong, Blunt	8 in 203 mm
20-2723E	Blunt, Ebonized	8 in 203 mm

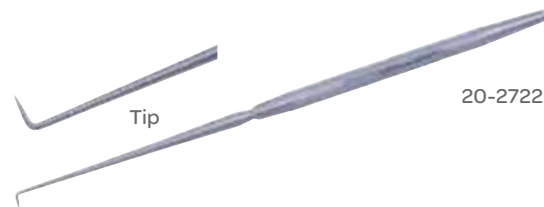

## Hooks

### Chamberlain-Fries Hook

CODE	DESCRIPTION	LENGTH
20-2040	Single	6½ in 165 mm



### Hook

CODE	DESCRIPTION
20-5012	Hook Single Prong, Large, Sharp



## Hooks (Nerve Hook)

### Adson Dura Hook

1 Prong, Blunt

CODE	TIP WIDTH	LENGTH
20-2057	7.0 mm	6¼ in 159 mm



## Hooks (Nerve)

### Cushing Nerve Hook

Ball Tip

CODE	TIP WIDTH	LENGTH
20-2231	4.0 mm	7½ in 191 mm
20-2232	6.0 mm	7½ in 191 mm
20-2236	6.0 mm	11 in 279 mm

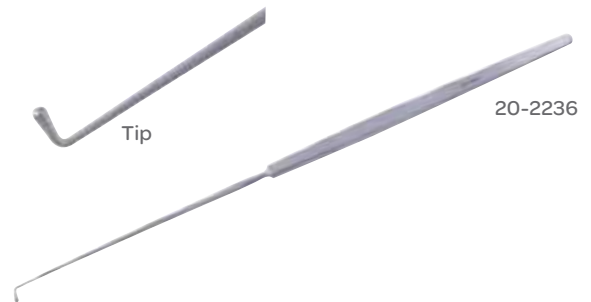

### Lucae Nerve Hook

Probe Tip

CODE	DESCRIPTION	LENGTH
20-2201	Small	5½ in 140 mm
20-2202	Medium	5½ in 140 mm
20-2203	Large	5½ in 140 mm

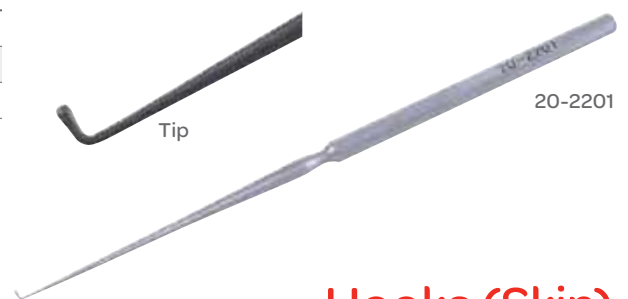

## Hooks (Skin)

### Barsky Skin Hook

CODE	DESCRIPTION	LENGTH
20-3501	1 Prong, Sharp	6 in 152 mm

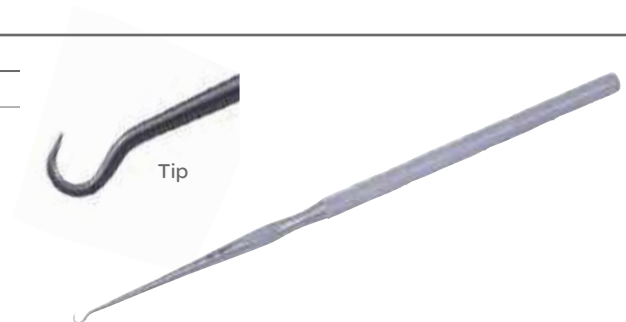

### Frazier Skin Hook

CODE	DESCRIPTION	LENGTH
20-3012	1 Prong, Small, Sharp	5 in 127 mm

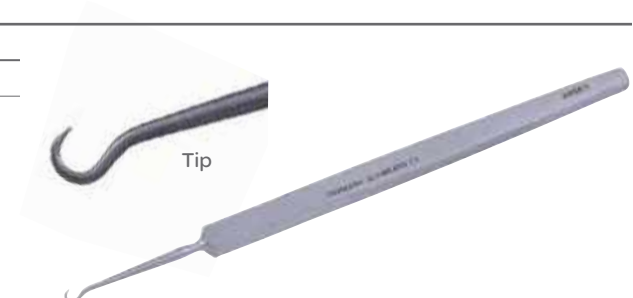

## Hooks (Skin)

### Gilles Skin Hook

1 Prong, Sharp

CODE	TIP WIDTH	LENGTH
20-3019	3.0 mm, Small	7 in 178 mm
20-3020	4.0 mm, Large	7½ in 191 mm

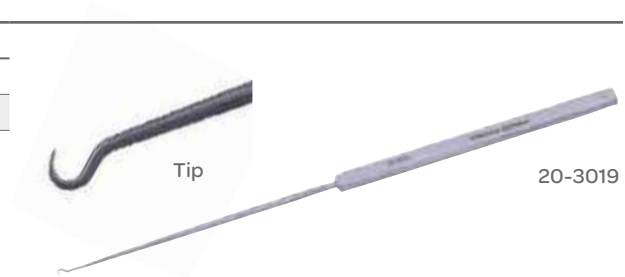

### Guthrie Skin Hook

1 Prong, Sharp

CODE	TIP WIDTH	LENGTH
20-5210	1.5 mm	5⅛ in 130 mm
20-5211	2.0 mm	5⅛ in 130 mm

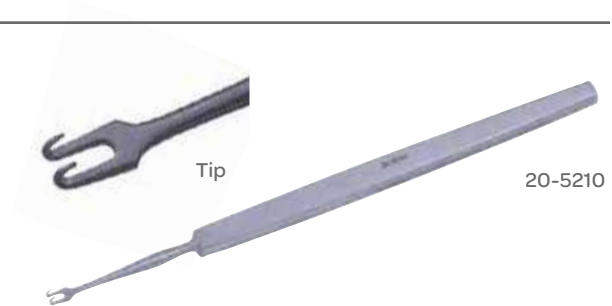

### Joseph Skin Hook

1 Prong, Sharp

CODE	TIP WIDTH	LENGTH
20-5001	4.0 mm	6¼ in 159 mm



### Kilner Skin Hook

CODE	DESCRIPTION	LENGTH
20-5109	Skin Hook	5 in 127 mm

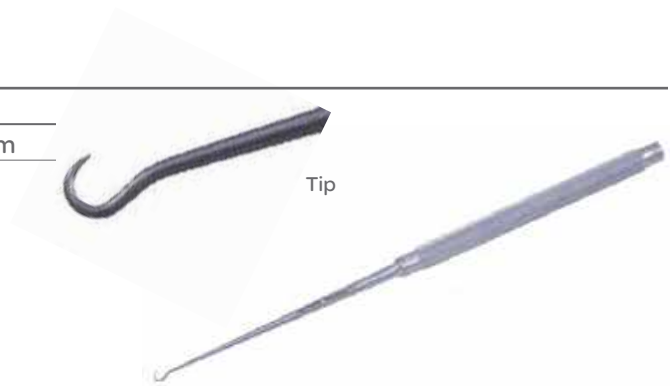

## Hooks (Skin Hook)

### Kleinert-Kutz Skin Hook

1 Prong, Sharp

CODE	DESCRIPTION	LENGTH
20-4803	#1, 3.0 mm	5 1/8 in 130 mm
20-4805	#2, 5.0 mm	5 1/8 in 130 mm
20-4807	#3, 7.0 mm	5 1/8 in 130 mm

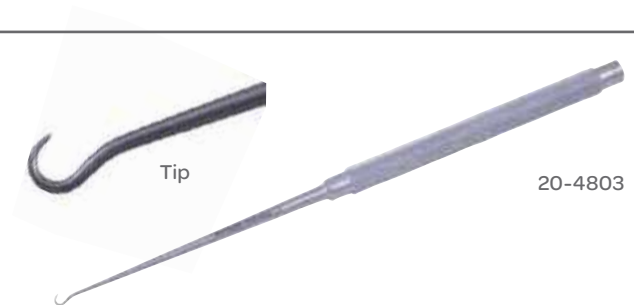

### Straight Skin Hook

CODE	DESCRIPTION	LENGTH
20-3113	1 Prong, Sharp	5 1/8 in 130 mm



## Hooks (Swivel)

### Humby Swivel Skin Hook

CODE	DESCRIPTION	LENGTH
20-3532	Sharp	4 1/2 in 114 mm



## Hooks (Tracheal Retractor)

### Tracheal Retractor

CODE	DESCRIPTION	LENGTH
20-6402	2 Prongs, Sharp	6 1/4 in 159 mm



## Hooks (Tracheal Retractor)

### Converse Skin Hook

Sharp

CODE	HOOK SIZE			LENGTH	
38-6638	1/8 in	3.0 mm	Small	7 1/4 in	184 mm
38-6640	1/5 in	5.0 mm	Large	7 1/4 in	184 mm



38-6638

### Gilles Skin Hook

Sharp

CODE	HOOK SIZE			LENGTH	
38-2520	1/5 in	3.0 mm		7 1/8 in	181 mm



### Guthrie Eye Fixation Hook

Standard

CODE	TIP WIDTH	LENGTH	
38-6530	2.0 mm	4 3/4 in	121 mm



### Guthrie Fixation Hook Del

Delicate

CODE	TIP WIDTH	LENGTH	
38-6531	1.0 mm	5 1/4 in	133 mm



## Hooks (Tracheal Retractor)

### Joseph Single Prong Nasal Hook

CODE	DESCRIPTION	LENGTH
38-6642	Single Prong Nasal Hook	6¼ in 159 mm



### Tyrell Iris Hook

CODE	TIP WIDTH	LENGTH
38-6525	0.4 mm, Sharp	4¾ in 121 mm



## Knives (Golf Stick)

### Golf Stick Knife

CODE	DESCRIPTION
43-4043	Stick Knife



## Knife Handles

### Corwin Knife Handle

CODE	DESCRIPTION	LENGTH
01-2740	Knife Handle	6¼ in 159 mm



## Knife Handles

### Javelin Micro-Knife Handles

Working Distance  $4\frac{2}{3}$  in (117 mm), Handle Diameter  $\frac{3}{11}$  in (7 mm)

CODE	DESCRIPTION	LENGTH
46-3177	2.0 mm Micro Tip	9 in 229 mm
46-3178	1.5 mm Ultra Tip	9 in 229 mm

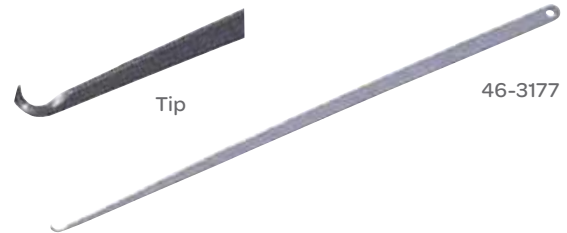

### Kaye Knife Handle

CODE	DESCRIPTION	LENGTH
01-6708	Lightweight (For BP Blades 10-15)	$6\frac{1}{8}$ in 156 mm



### Knife Handle

CODE	DESCRIPTION	LENGTH
01-2003	Octagonal	$5\frac{1}{4}$ in 133 mm



### Knife Handle

CODE	DESCRIPTION	LENGTH
01-2723	#3LA, Angled	$8\frac{3}{8}$ in 213 mm
01-2713	#3L, Long	$8\frac{3}{8}$ in 213 mm
01-2703	#3, Standard	5 in 127 mm
01-2733	#3, Standard	12 in 305 mm
01-2746	#3, Standard	16 in 406 mm



## Knife Handles

### Knife Handle

CODE	DESCRIPTION	LENGTH
01-2707	#7, Standard	6½ in 165 mm
01-2708	#7, Standard	9 in 229 mm



01-2708

### Knife Handle

CODE	DESCRIPTION	LENGTH
01-2709	#9, Standard	5 in 127 mm



### Knife Handle

CODE	DESCRIPTION	LENGTH
01-2804	#4, Standard	5¼ in 133 mm
01-2814	#4L, Long	8¾ in 213 mm



01-2804

### Knife Handle

CODE	DESCRIPTION	LENGTH
01-2850	Round (3K)	4 in 102 mm





## Knife Handles

### Knife Handle

CODE	DESCRIPTION	LENGTH
01-3032L	Round	6¼ in 159 mm



### Knife Handle

CODE	DESCRIPTION	LENGTH
01-3034	Hexagonal	4 in 102 mm
01-3036	Hexagonal	6 in 152 mm



01-3034

### Knife Handle

CODE	DESCRIPTION	LENGTH
11-5530	#3	4⅞ in 124 mm
11-5531	#4	5¼ in 133 mm
11-5534	#7	6¼ in 159 mm
11-5535	#3 Long	8⅜ in 213 mm



11-5531

## Markers (Surgical)

### Surgical Marker

Gentian Violet Dye, Sterile, Disposable, Packaged with 6 inch Ruler

CODE	DESCRIPTION	QTY
43-1030	Regular Tip	36/Box
43-1032	Micro Tip	36/Box



43-1030

## Nail Nippers

### Nail Nipper

CODE	DESCRIPTION	LENGTH
43-7081	Sharp End, Concave Jaw	5½ in 140 mm



### Nail Nipper

CODE	DESCRIPTION	LENGTH
43-7082	Barrel Spring, Concave Jaw	4½ in 114 mm
43-7083	Barrel Spring, Concave Jaw	5½ in 140 mm



43-7083

## Nail Nippers

### Nail Nipper

CODE	DESCRIPTION	LENGTH
43-7313	Stainless Steel, Straight Jaw	5 in 127 mm



### Nail Nipper

CODE	DESCRIPTION	LENGTH
43-7514	Double Spring, Concave Jaw	5½ in 140 mm
43-7515	Double Spring, Straight Jaw	5½ in 140 mm



### Nail Nipper

CODE	DESCRIPTION	LENGTH
43-7592	⅞ in 11 mm	4½ in 114 mm



### Nail Nipper

CODE	DESCRIPTION	LENGTH
43-7810	Straight Jaw, Double Spring	4 in 102 mm



## Nail Nippers

### Mycotic Nail Nipper

CODE	DESCRIPTION	LENGTH
43-0446	Double Action, Barrel Spring	6 in 152 mm

## Nail Nippers (Tissue & Cuticle)

### Tissue & Cuticle Nipper

CODE	DESCRIPTION	LENGTH
43-7594	Convex Jaw	5 in 127 mm



## Nail Nippers

### Nail Nipper

CODE	DESCRIPTION	LENGTH
43-7914	English Anvil, Double Spring	5 in 127 mm



### Nail Nipper

Curved Back, Straight Jaws

CODE	DESCRIPTION	LENGTH
43-7813	Stainless Steel	4 in 102 mm
43-7812	Heavy Pattern	4 in 102 mm



43-7813

## Nail Splitters

### Nail Splitter

Straight, Single End

CODE	DESCRIPTION	LENGTH
43-0557	Small Blade	5 in 127 mm
43-0560	Large Blade	5 in 127 mm



43-0557

## Needle Holders (Combination with Scissor)

### Gillies Needle Holder & Scissor Holder

CODE	DESCRIPTION	LENGTH
32-425	Tungsten Carbide Inserts, Use with 2-0, 3-0 Suture	6½ in 165 mm



## Needle Holders (Double Action)

### Double Action Needle Holder

Jaw Surface with Fine Tungsten Carbide Dust, Use with 5-0, 6-0 and 7-0 Suture, Round Handle

CODE	DESCRIPTION	LENGTH
55-2604	Straight without Lock	7¼ in 184 mm
55-2612	Straight without Lock	9 in 229 mm
55-2610	Straight with Lock	9 in 229 mm
55-2608	Curved without Lock	7¼ in 184 mm

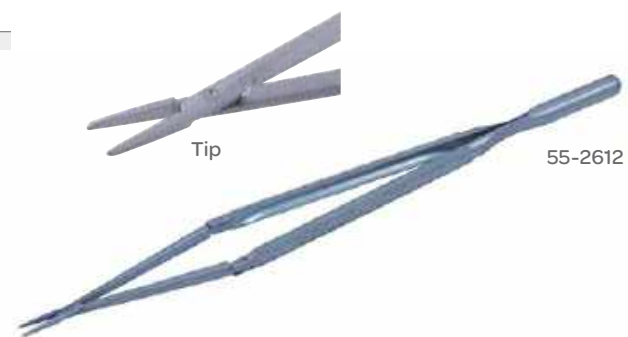

55-2612

## Needle Holders (Micro)

### Castroviejo (Jacobson Style) Heavy Needle Holder

Straight, Tungsten Carbide Inserts, Use with 1-0, 2-0, 3-0 Suture, Serrated Jaws

CODE	DESCRIPTION	LENGTH
32-449	Flat Handle with Lock	7¼ in 184 mm
32-439	Flat Handle with Lock	8¼ in 210 mm



### Jacobson Heavy Needle Holder

Straight, use with 1-0, 2-0 and 3-0 Suture, Round Handle, with Lock

CODE	DESCRIPTION	LENGTH
32-470	Tungsten Carbide Inserts	7¾ in 197 mm
32-471	Tungsten Carbide Inserts	9¼ in 235 mm
32-473	Tungsten Carbide Inserts	10 in 254 mm



## Needle Holders (Micro)

### Double Action Titanium Needle Holder

Jaw Surfaces with Tungsten Carbide Dust

CODE	DESCRIPTION	LENGTH
55-2612T	Straight	9 in 229 mm



## Needle Holders (Micro)



### Jacobson Micro Needle Holder

Tungsten Carbide Inserts, Straight

CODE	TIP	HANDLE	LENGTH
32-480	Smooth, Use with 4-0, 5-0 and 6-0 Suture	Flat Handle with Lock	7 in 178 mm
32-488	Serrated, Use with 3-0 and 4-0 Suture	Round Handle without Lock	7¼ in 184 mm
32-492	Serrated, Use with 3-0 and 4-0 Suture	Round Handle without Lock	8¼ in 210 mm
32-493	Serrated, Use with 3-0 and 4-0 Suture	Round Handle without Lock	9 in 229 mm

### Jacobson Micro Needle Holder

Tungsten Carbide Dust Jaws, Straight, Round Handle with Short Knurling

CODE	TIP	HANDLE	LENGTH
55-2527	Delicate Tips, Use with 7-0 and 8-0 Suture	With Lock	8¼ in 210 mm
55-2531	Delicate Tips, Use with 7-0 and 8-0 Suture	With Lock	9 in 229 mm
55-2528	Delicate Tips, Use with 7-0 and 8-0 Suture	Without Lock	8¼ in 210 mm
55-2532	Delicate Tips, Use with 7-0 and 8-0 Suture	Without Lock	9 in 229 mm

### Jacobson Micro Needle Holder

Tungsten Carbide Dust Jaws, Round Handle

CODE	TIP	HANDLE	LENGTH
55-2523	Straight, Use with 5-0, 6-0 and 7-0 Suture	With Lock	7¼ in 184 mm
55-2525	Straight, Use with 5-0, 6-0 and 7-0 Suture	With Lock	8¼ in 210 mm
55-2536	Straight, Use with 5-0, 6-0 and 7-0 Suture	With Lock	9¼ in 235 mm
55-2423	Curved, Use with 5-0, 6-0 and 7-0 Suture	With Lock	7¼ in 184 mm

### Jacobson Micro Needle Holder

Tungsten Carbide Dust Jaws, Round Handle

CODE	TIP	HANDLE	LENGTH
55-2549	Straight, Use with 5-0, 6-0 Suture	With Lock	9 in 229 mm
55-2524	Straight, Use with 5-0, 6-0 Suture	Without Lock	7¼ in 184 mm
55-2526	Straight, Use with 5-0, 6-0 Suture	Without Lock	8½ in 216 mm
55-2535	Straight, Use with 5-0, 6-0 Suture	Without Lock	9¼ in 235 mm
55-2530	Curved, Use with 5-0, 6-0 Suture	Without Lock	8½ in 216 mm

## Needle Holders (Micro)



### Jacobson Micro Needle Holder

Tungsten Carbide Dust Jaws, Round Handle

CODE	TIP	HANDLE	LENGTH
55-2541	Straight, Use with 7-0 and 8-0 Suture	With Lock	7¼ in 184 mm
55-2540	Curved, Use with 7-0 and 8-0 Suture	With Lock	7¼ in 184 mm

### Jacobson Micro Needle Holder

Finely Serrated Stainless Steel Jaws, Flat Handle

CODE	TIP	HANDLE	LENGTH
55-2500	Straight, Use with 4-0, 5-0 and 6-0 Suture	With Lock	7 in 178 mm
55-2510	Straight, Use with 4-0, 5-0 and 6-0 Suture	With Lock	9 in 229 mm

### Jacobson Micro Needle Holder

Tungsten Carbide Dust Jaws, Flat Knurled Handle

CODE	TIP	HANDLE	LENGTH
55-2547	Straight, Use with 5-0 and Smaller Suture	With Lock	8 in 203 mm

### Jacobson Micro Needle Holder

Tungsten Carbide Dust Jaws, Flat Handle

CODE	TIP	HANDLE	LENGTH
55-2550	Straight, Use with 6-0, 7-0 and 8-0 Suture	With Lock	7 in 178 mm
55-2555	Straight, Use with 6-0, 7-0 and 8-0 Suture	With Lock	7¼ in 184 mm
55-2560	Straight, Use with 6-0, 7-0 and 8-0 Suture	With Lock	8¼ in 210 mm
55-2565	Straight, Use with 6-0, 7-0 and 8-0 Suture	With Lock	9¾ in 238 mm
55-2566	Straight, Use with 6-0, 7-0 and 8-0 Suture	Without Lock	9½ in 241 mm



## Needle Holders (Micro)

### Jacobson Micro Needle Holder

Straight, Slim Pattern, Jaw Surface with Fine Tungsten Carbide Dust, Use with 7-0 and 8-0 Suture, Slim Line Jacobson

CODE	DESCRIPTION	LENGTH
55-2727	Round Handle with Lock	8¼ in 210 mm
55-2728	Round Handle with Lock	8¼ in 210 mm



55-2727

### Jacobson Micro Needle Holder

Straight, Jaw Surfaces with Tungsten Carbide Dust, Use with 5-0, 6-0 Suture

CODE	DESCRIPTION	LENGTH
55-2549	Round Handle with Lock	9 in 229 mm



### Micro Needle Holder

Straight, Smooth Jaws

CODE	DESCRIPTION	LENGTH
58-1515	Round Handle with Lock	7 in 178 mm



## Needle Holders (Micro)

### Micro Needle Holder

Tip Width 0.5 mm

CODE	DESCRIPTION	LENGTH
80-2002	Straight Tip	5½ in 140 mm
80-2003	Curved Tip	5½ in 140 mm



### Castroviejo Microsurgical Needle Holder

Tungsten Carbide Inserts with Lock

CODE	DESCRIPTION	LENGTH
36-1006	Smooth Jaws	5½ in 140 mm
36-1007	Smooth Jaws	7 in 178 mm
36-1008	Smooth Jaws	8½ in 216 mm



## Needle Holders

### Microvascular Classic Plus® Needle Holder

CODE	DESCRIPTION	LENGTH
36-3011	Tungsten Carbide Jaw Inserts, with Lock	9 in 229 mm



### Microvascular Needle Holder

Tungsten Carbide Inserts, Use with 5-0 and 6-0 Suture, Ring Handle

CODE	DESCRIPTION	TIP WIDTH	LENGTH
32-431	Serrated Jaw	1.0 mm	6 in 152 mm
32-322	Serrated Jaw	1.0 mm	7 in 178 mm
32-327	Serrated Jaw	1.0 mm	8 in 203 mm
32-352	Serrated Jaw	1.0 mm	9¼ in 235 mm

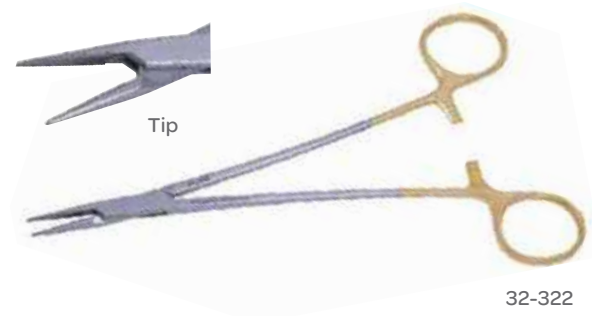

## Needle Holders (Micro)



### Microvascular Classic Plus® Needle Holder

CODE	DESCRIPTION	LENGTH
36-3010	Tungsten Carbide Jaw Inserts	7 in 178 mm



### Ultra™ Micro Needle Holder

Jaw Surface with Fine Tungsten Carbide Dust

CODE	DESCRIPTION	LENGTH
55-2513	Straight, Delicate, Serrated, Use with 7-0 and 8-0 Suture Round Handle, with Lock	7 in 178 mm
55-2515	Straight, Delicate, Serrated, Use with 7-0 and 8-0 Suture Round Handle, with Lock	9 in 229 mm
55-2518	1.0 mm Jaw (25 mm), Use with 5-0, 6-0 and 7-0 Suture Ring Handle	5 in 127 mm
55-2519	1.0 mm Jaw (25 mm), Use with 5-0, 6-0 and 7-0 Suture Ring Handle	5¾ in 146 mm
55-2520	1.0 mm Jaw (25 mm), Use with 5-0, 6-0 and 7-0 Suture Ring Handle	6½ in 165 mm
55-2521	1.0 mm Jaw (25 mm), Use with 5-0, 6-0 and 7-0 Suture, Ring Handle	7¼ in 184 mm
55-2522	1.0 mm Jaw (25 mm), Use with 5-0, 6-0 and 7-0 Suture, Ring Handle	8½ in 216 mm

## Needle Holders (Titanium)



### Cardiovascular Titanium Needle Holder

Jaw Surfaces with Fine Tungsten Carbide Dust

CODE	DESCRIPTION	LENGTH
55-0366T	Straight, Ring Handle	10 in 254 mm

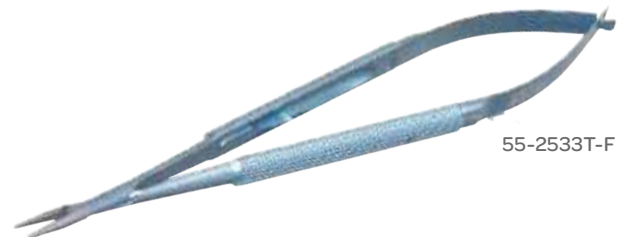

### Cardiovascular Titanium Needle Holder

Jaw Surfaces with Tungsten Carbide Dust, Round Handle

CODE	DESCRIPTION	LENGTH
55-2533T-F	Straight, Slim Line Pattern, Use with 7-0 and 8-0 Suture, with Lock	6 in 152 mm
55-2533T	Straight, Use with 5-0, and 6-0 Suture, with Lock	6 ½ in 165 mm
55-2534T	Straight, Use with 5-0, and 6-0 Suture, without Lock	6 ½ in 165 mm
55-2538T	Curved, Use with 5-0, and 6-0 Suture, without Lock	6 ½ in 165 mm

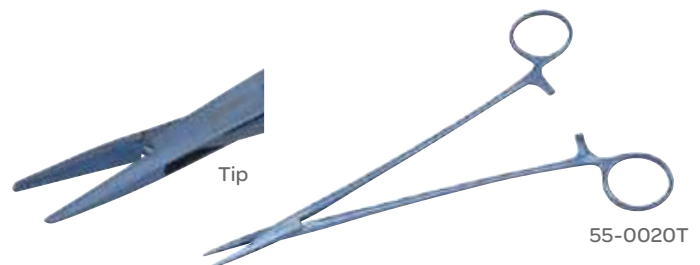

### DeBakey Titanium Needle Holder

Straight, Jaw Surfaces with Fine Tungsten Carbide Dust, Ring Handle

CODE	DESCRIPTION	LENGTH
55-0010T	Titanium Needle Holder	7 ¼ in 184 mm
55-0015T	Titanium Needle Holder	8 in 203 mm
55-0020T	Titanium Needle Holder	9 in 229 mm
55-0030T	Titanium Needle Holder	10 in 254 mm

## Needle Holders (Titanium)



Tip



80-6006

### Needle Holders

Curved, Titanium

CODE	DESCRIPTION	TIP WIDTH	LENGTH	
80-6621	Extra Fine	0.5 mm	6 in	152 mm
80-6006	Fine Tip	0.7 mm	6 in	152 mm
80-6007	Standard Tip	1.0 mm	6 in	152 mm



55-2555T-F

### Jacobson Micro Titanium Needle Holder, Straight

Jaw Surfaces with Tungsten Carbide Dust

CODE	DESCRIPTION	HANDLE	LENGTH	
55-2526T	Use with 5-0 and 6-0 Suture	Without Lock	8 ¼ in	210 mm
55-2531T	Straight	Round Handle, with Lock	9 in	229 mm
55-2543T	Delicate	Round Handle	10 in	254 mm
55-2523T-F	Use with 5-0 and 6-0 Suture	Round Handle, with Lock	7 in	178 mm
55-2524T	Use with 5-0 and 6-0 Suture	Round Handle, with Lock	7 ¼ in	184 mm
55-2556T	Use with 6-0, 7-0 and 8-0 Suture	Flat Handle, without Lock	7 ¼ in	184 mm
55-2565T	Use with 6-0, 7-0 and 8-0 Suture	Flat Handle, with Lock	9 in	229 mm
55-2555T-F	Slim Line Pattern	Flat Handle, with Lock	7 ¼ in	184 mm
55-2525T-F	Slim Line Pattern, Use with 7-0 and 8-0 Suture	Round Handle, with Lock	8 ¼ in	210 mm
55-2531T-F	Slim Line Pattern, Use with 7-0 and 8-0 Suture	Round Handle, with Lock	9 in	229 mm
55-2543T-F	Slim Line Pattern, Use with 5-0, 6-0 and 7-0 Suture	Round Handle, with Lock	10 in	254 mm



55-2423T-F

### Jacobson Micro Titanium Needle Holder, Curved

Jaw Surfaces with Tungsten Carbide Dust

CODE	DESCRIPTION	HANDLE	LENGTH	
55-2423T-F	Use with 5-0 and 6-0 Suture	Round Handle, with Lock	7 in	178 mm
55-2424T	Use with 5-0 and 6-0 Suture	Round Handle, without Lock	7 ¼ in	184 mm
55-2530T	Use with 5-0 and 6-0 Suture	Round Handle, without Lock	8 ¼ in	210 mm
55-2557T	Use with 6-0, 7-0 and 8-0 Suture	Flat Handle, with Lock	7 ¼ in	184 mm
55-2558T	Use with 6-0, 7-0 and 8-0 Suture	Flat Handle, without Lock	7 ¼ in	184 mm
55-2560T	Use with 6-0, 7-0 and 8-0 Suture	Flat Handle, with Lock	8 ½ in	216 mm
55-2560T-F	Slim Line Pattern	Flat Handle, with Lock	8 ½ in	216 mm

## Needle Holders



55-2555T

### Jacobson Titanium Micro Needle Holder

Flat Handle with Lock, Jaw Surfaces with Tungsten Carbide Dust

CODE	DESCRIPTION	LENGTH
55-2555T	Straight, Use with 6-0, 7-0 and 8-0 Suture	7¼ in 184 mm
55-2557T	Curved, Use with 6-0, 7-0 and 8-0 Suture	7¼ in 184 mm



55-2523T

### Jacobson Titanium Needle Holder

Jaw Surfaces with Fine Tungsten Carbide Dust Use with 5-0, and 6-0 Suture, Round Handle with Lock

CODE	DESCRIPTION	LENGTH
55-2523T	Straight	7¼ in 184 mm
55-2525T	Straight	8 in 203 mm
55-2529T	Curved	8 in 203 mm



### MagnaFree® MRI Mayo-Hegar Needle Holder

CODE	DESCRIPTION	LENGTH
65-2414	Non-Magnetic (Titanium) for Interventional MRI	7 in 178 mm

## Needle Holders (Titanium)

### Verity™ Needle Holder

Tip Width 0.5 mm, Titanium

CODE	DESCRIPTION	LENGTH
80-1510	Straight Tip	6 <sup>3</sup> / <sub>4</sub> in 171 mm
80-1511	Curved Tip	6 <sup>3</sup> / <sub>4</sub> in 171 mm



80-1510

### Verity™ Needle Holder

Titanium, Straight Tip

CODE	DESCRIPTION	TIP WIDTH	LENGTH
80-1515	Bayonet	0.4 mm	8 <sup>3</sup> / <sub>4</sub> in 222 mm
80-1512	Bayonet	0.6 mm	8 <sup>3</sup> / <sub>4</sub> in 222 mm
80-1514	Fine	0.5 mm	6 <sup>3</sup> / <sub>4</sub> in 171 mm

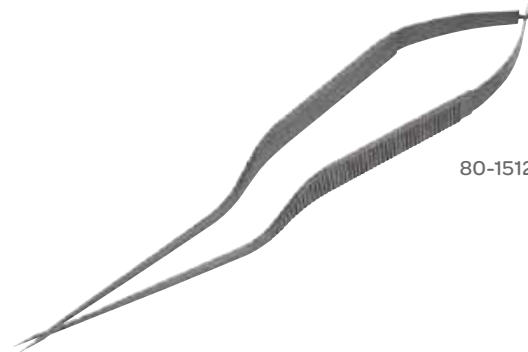

80-1512

### Mayo Hegar Titanium Needle Holder

Jaw Surfaces with Fine Tungsten Carbide Dust, Ring Handle

CODE	DESCRIPTION	LENGTH
55-0120T	Straight	6 <sup>1</sup> / <sub>4</sub> in 159 mm
55-0130T	Straight	7 <sup>1</sup> / <sub>8</sub> in 181 mm
55-0140T	Straight	8 in 203 mm

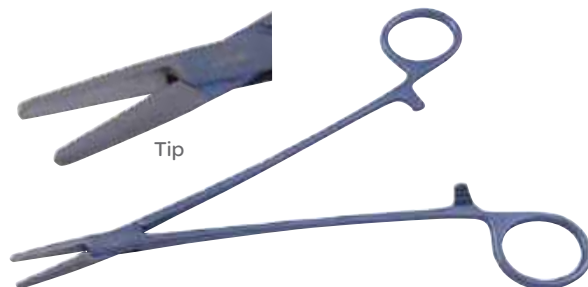

Tip

## Needle Holders (Titanium)

### Micro Titanium Needle Holder

Smooth Jaws, Round Handle

CODE	DESCRIPTION	LENGTH	
60-5510	Straight, with Lock	5 in	127 mm
60-5509	Straight, without Lock	5 in	127 mm
60-5520	Straight, without Lock	5 $\frac{3}{8}$ in	137 mm
60-5511	Curved, without Lock	5 in	127 mm

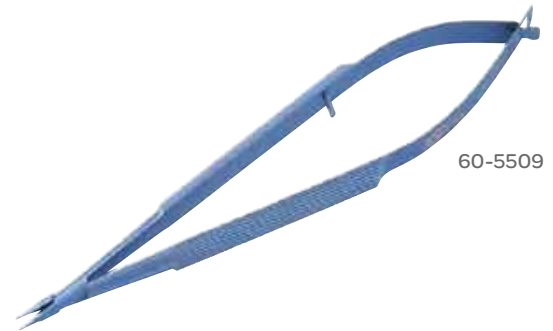

60-5509

### Microvascular Titanium Needle Holder

Jaw Surfaces with Fine Tungsten Carbide Dust, Ring Handle

CODE	DESCRIPTION	LENGTH	
55-0322T	Straight	7 $\frac{3}{8}$ in	187 mm
55-0352T	Straight	8 $\frac{5}{8}$ in	219 mm
55-0362T	Straight	10 in	254 mm



55-0322T

### Rhoton® Needle Holder

Titanium

CODE	DESCRIPTION	TIP WIDTH	LENGTH	
80-1726	Straight	0.9 mm	7 in	178 mm
80-1725	Curved, Fine	0.5 mm	7 in	178 mm
80-1727	Curved	0.9 mm	7 in	178 mm

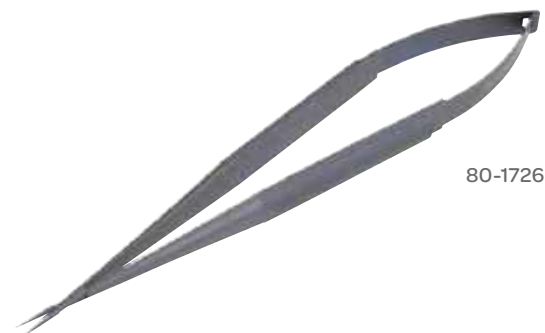

80-1726



## Needle Holders (Titanium)

### Rhoton® Needle Holders

Bayonet, Titanium

CODE	DESCRIPTION	TIP WIDTH	LENGTH
80-1728	Straight	0.9 mm	8 ½ in 216 mm
80-1746	Straight		9 ½ in 241 mm
80-1729	Curved	0.9 mm	8 ½ in 216 mm
80-1747	Curved		9 ½ in 241 mm



### Ryder Titanium Needle Holder

Ring Handle, Jaw Surfaces with Fine Tungsten Carbide Dust

CODE	DESCRIPTION	LENGTH
55-0466T	Straight	6 in 152 mm

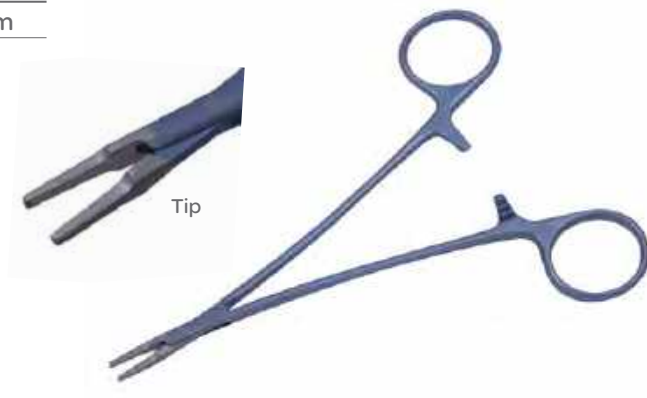

## Needle Holders (Wire Twister)

### Rubio Wire Twister

Snub Nose, Tungsten Carbide Inserts

CODE	DESCRIPTION	LENGTH
32-302	Ring Handle	5 ¼ in 133 mm



## Needle Holders (Wire Twister)

### Sternal Classic Plus® Needle Holder & Wire Twister

CODE	DESCRIPTION	LENGTH
36-2025	Tungsten Carbide Jaw Inserts	7 in 178 mm



### Sternal Wire Twister

Ultra™, Tungsten Carbide Inserts, Use with Sternal Needles and Wire 1-5

CODE	DESCRIPTION	LENGTH
32-132	Ring Handle	8¼ in 210 mm



### Ultra™ Sternal Needle Holder

Ultra™, 6.0 mm Jaws, Tungsten Carbide Inserts

CODE	DESCRIPTION	LENGTH
32-303	Ring Handle	7¼ in 184 mm



### Ultra™ Sternal Needle Holder & Wire Twister

Ultra™, 6.0 mm Jaws, Tungsten Carbide Inserts

CODE	DESCRIPTION	LENGTH
32-134	Ring Handle	7¼ in 184 mm



## Needle Holders

### Adson Dural Needle Holder

CODE	DESCRIPTION	LENGTH
64-1000	Fenestrated Jaws	7¼ in 184 mm



### Baumgartner Needle Holder

Tungsten Carbide Inserts, Ring Handle

CODE	DESCRIPTION	LENGTH
32-110	Use with 2-0, 3-0, 4-0 Suture	5 in 127 mm



### Baumgartner Classic Plus® Needle Holder

CODE	DESCRIPTION	LENGTH
36-2010	Tungsten Carbide Jaw Inserts	5 in 127 mm



### Bayonet Needle Holder

CODE	DESCRIPTION	LENGTH
32-157	Tungsten Carbide	7 in 178 mm



## Needle Holders

### Brown Needle Holders

Convex Jaws, Fine Serrations

CODE	DESCRIPTION	LENGTH
10-0902	Ring Handle	5¼ in 133 mm



### Castroviejo Needle Holders

Tungsten Carbide Inserts, Use with 5-0, 6-0 and 7-0 Suture

CODE	DESCRIPTION	LENGTH
32-440	Straight, Flat Spring Handle with Lock	5½ in 140 mm
32-444	Straight, Flat Spring Handle with Lock	7 in 178 mm
32-442	Straight, Flat Handle with Lock	8½ in 216 mm
32-441	Curved, Flat Spring Handle with Lock	5½ in 140 mm



32-440

### Castroviejo Needle Holders

Straight, Jaw Surfaces with Fine Tungsten Carbide Dust

CODE	DESCRIPTION	LENGTH
55-2533	Round Handle with Lock	5¾ in 146 mm
55-2534	Round Handle without Lock	5¾ in 146 mm



55-2533

### Castroviejo (Jacobson Style) Needle Holders

Tungsten Carbide Inserts, Use with 5-0, 6-0 and 7-0 Suture

CODE	DESCRIPTION	LENGTH
32-446	Curved, Smooth Jaws, Flat Handle with Lock	5½ in 140 mm



## Needle Holders

### Castroviejo Needle Holders

CODE	DESCRIPTION	LENGTH
36-1000	Tungsten Carbide Inserts with Lock	5½ in 140 mm
36-1002	Tungsten Carbide Inserts with Lock	7 in 178 mm
36-1001	Tungsten Carbide Inserts with Lock	8½ in 216 mm



36-1000

### Castroviejo-Ryder Needle Holders

1.0 mm Jaws Tungsten Carbide Inserts, Use with 5-0, 6-0 and 7-0 Suture

CODE	DESCRIPTION	LENGTH
32-454	Flat Handle	5½ in 140 mm
32-455	Flat Handle	7¼ in 184 mm
32-456	Flat Handle	8½ in 216 mm



32-454

### Cooley Needle Holders

CODE	DESCRIPTION	LENGTH
32-458	Serrated, Jaw Tungsten Carbide Inserts, Delicate, Use with 5.0 and 6.0 Suture	6¾ in 171 mm
32-457	Serrated, Jaw Tungsten Carbide Inserts	6 in 152 mm
32-462	Extra Delicate	8 in 203 mm



## Needle Holders

### Crile Wood Needle Holder

Use with 3-0 and 4-0 Suture, Ring Handle, Tungsten Carbide Inserts

CODE	DESCRIPTION	LENGTH
32-435	Straight, Smooth Jaw	6 ¼ in 159 mm
32-430	Straight, Serrated Jaw	5 7/8 in 149 mm
32-320	Straight, Serrated Jaw	7 1/8 in 181 mm
32-325	Straight, Serrated Jaw	8 in 203 mm
32-350	Straight, Serrated Jaw	9 ½ in 241 mm
32-365	Straight, Serrated Jaw	10 1/8 in 257 mm
32-310	Straight, Serrated Jaw	11 ¾ in 298 mm
32-330	Curved, Serrated Jaw	7 1/8 in 181 mm
32-360	Curved, Serrated Jaw	9 in 229 mm
32-350L	Serrated Jaw, Left Handed Pattern	9 in 229 mm



32-310

### Crile Wood Needle Holder

Use with 3-0 and 4-0 Suture, Ring Handle

CODE	DESCRIPTION	LENGTH
10-2015	Needle Holder	5 7/8 in 149 mm
10-2018	Needle Holder	7 in 178 mm
10-2020	Needle Holder	8 in 203 mm

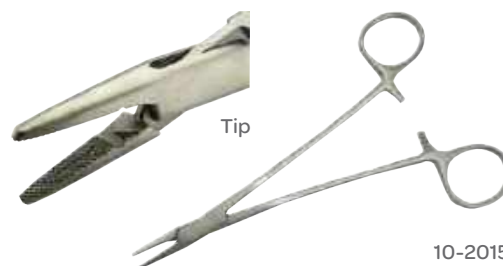

10-2015

### Crile-Wood Bariatric Needle Holder

CODE	DESCRIPTION	LENGTH
32-3685	Tungsten Carbide Insert	14 in 356 mm



### Crile-Wood Bariatric Needle Holder

CODE	DESCRIPTION	LENGTH
36-2000	Tungsten Carbide Jaw Inserts	6 in 152 mm
64-2509	Tungsten Carbide Jaw Inserts	6 in 152 mm
36-2001	Tungsten Carbide Jaw Inserts	7 in 178 mm
36-2002	Tungsten Carbide Jaw Inserts	8 in 203 mm
36-2003	Tungsten Carbide Jaw Inserts	9 in 229 mm
36-2004	Tungsten Carbide Jaw Inserts	10 in 254 mm
36-2005	Tungsten Carbide Jaw Inserts	12 in 305 mm



36-2000

## Needle Holders

### DeBakey Needle Holder

2.0 mm Tips, Serrated Jaw, Tungsten Carbide Inserts, Use with 3-0 and 4-0 Suture

CODE	DESCRIPTION	LENGTH
32-010	Ring Handle	7 ¼ in 181 mm
32-030	Ring Handle	10 ¼ in 260 mm
32-040	Ring Handle	12 ¼ in 311 mm



32-010

### DeBakey Ultra Light Needle Holder

1.0 mm Tip, Jaws Have Tungsten Carbide Inserts, Use 5-0 and 6-0 Suture

CODE	DESCRIPTION	LENGTH
32-001	Ring Handle	6 ¼ in 159 mm
32-002	Ring Handle	7 in 178 mm
32-003	Ring Handle	8 in 203 mm
32-004	Ring Handle	9 in 229 mm



32-001

### Deithrich Needle Holder

1.0 mm Tips, Serrated Jaw, Tungsten Carbide Inserts, Use with 6-0, 7-0 and 8-0 Suture

CODE	DESCRIPTION	LENGTH
32-453	Spring/Ring Handle with Lock	6 ¼ in 159 mm
32-450	Spring/Ring Handle with Lock	7 in 178 mm
32-451	Spring/Ring Handle with Lock	8 in 203 mm



32-450

## Needle Holders

### Derf Needle Holders

CODE	DESCRIPTION	LENGTH
10-1212	Ring Handle	5 in 127 mm



### Derf (Webster) Needle Holder

Tungsten Carbide Inserts, Use with 4-0, 5-0, 6-0 Suture, Ring Handle

CODE	DESCRIPTION	LENGTH
32-400	Standard Pattern	4 ¾ in 121 mm
32-400L	Left-Handed Pattern	4 ¾ in 121 mm



### Derf Needle Holders

CODE	DESCRIPTION	LENGTH
36-1010	Tungsten Carbide Jaw Inserts	5 in 127 mm



### Diethrich Micro Needle Holders

1.0 mm Jaw (25 mm), Jaw Surface with Fine Tungsten Carbide Dust, Use with 6-0, 7-0 and 8-0 Suture

CODE	DESCRIPTION	LENGTH
55-2570	Flat Handle	5 ¾ in 146 mm





## Needle Holders

### Euphrate-Pasque Needle Holder

Tungsten Carbide Inserts, Use with 6-0, 7-0 and 8-0 Suture, Ring Handle

CODE	DESCRIPTION	LENGTH
32-153	Micro Insert	7 in 178 mm
32-155	Micro Insert	8 in 203 mm
32-152	Smooth Insert	6 in 152 mm
32-153	Smooth Insert	7 in 178 mm
32-156	Smooth Insert	8 in 203 mm



32-152

### French Eye Needle Holder

Tungsten Carbide Inserts, Use with 1-0, 2-0 and 3-0 Suture

CODE	DESCRIPTION	LENGTH
32-200	Ring Handle	6 1/8 in 156 mm
32-210	Ring Handle	7 1/8 in 181 mm



32-200

### Halsey Needle Holder

Ring Handle

CODE	DESCRIPTION	LENGTH
10-1013	Smooth Jaws	5 in 127 mm
10-1213	Serrated Jaws	5 in 127 mm



10-1213

### Halsey Needle Holder

Ring Handle, Tungsten Carbide Inserts, Use With 5-0, 6-0 Suture

CODE	DESCRIPTION	LENGTH
32-415	Smooth Jaws	5 1/8 in 130 mm
32-410	Serrated Jaws	5 1/8 in 130 mm



32-415

## Needle Holders

### Halsey Needle Holder

Tungsten Carbide Inserts

CODE	DESCRIPTION	LENGTH
36-1016	Smooth Jaws	5 in 127 mm
36-1015	Serrated Jaws	5 in 127 mm



36-1015

### Halsey Needle Holder

Fine Tungsten Carbide Inserts, Use with 1-0, 2-0 and 3-0 Suture, Curved

CODE	DESCRIPTION	LENGTH
32-230	Ring Handle	8 in 203 mm
32-230L	Left Handed	8 in 203 mm
10-3121	Serrated, Ring Handle	8 ¼ in 210 mm
32-235	Ring Handle	10 ½ in 267 mm
32-236		12 in 305 mm
32-239	Ring Handle	14 in 356 mm



32-230

### Halsey Needle Holder

CODE	DESCRIPTION	LENGTH
64-6558	Smooth Jaws, Stainless Steel	5 in 127 mm



64-6558

## Needle Holders

### Heaney Classic Plus® Needle Holders

CODE	DESCRIPTION	LENGTH
36-4010	Curved Tip, Tungsten Carbide Inserts	8¼ in 210 mm



### Heaney Needle Holder

CODE	DESCRIPTION	LENGTH
32-3687	Curved, Serrated	14 in 356 mm



### Heaney Needle Holder

CODE	DESCRIPTION	LENGTH
64-2595	Curved, Serrated	8¼ in 210 mm



### Intracardiac (Ryder) Needle Holder

2.0 mm Tips, Serrated Jaw, Tungsten Carbide Inserts, Use with 3-0, 4-0 and 5-0 Suture

CODE	DESCRIPTION	LENGTH
32-326	Ring Handle	8 in 203 mm
32-366	Ring Handle	10¼ in 260 mm
32-368	Ring Handle	12 in 305 mm



32-368

## Needle Holders

### Jacobson Needle Holder

Jaws Have Tungsten Carbide Inserts, Use with 3-0, and 4-0 Suture, Round Handle with Lock

CODE	DESCRIPTION	LENGTH
32-497	Straight	5 <sup>7</sup> / <sub>8</sub> in 149 mm
32-489	Straight	7 in 178 mm
32-490	Straight	8 <sup>1</sup> / <sub>4</sub> in 210 mm
32-491	Straight	9 in 229 mm
32-495	Curved	9 in 229 mm



32-489

### Jacobson Needle Holders

Straight, Smooth Jaws, Titanium

CODE	DESCRIPTION	LENGTH
80-1866	With Lock	7 in 178 mm
80-1867	Without Lock	7 in 178 mm



80-1867

### Jacobson Needle Holders

Straight, Smooth Jaws, Titanium

CODE	DESCRIPTION	LENGTH
80-1868	With Lock	8 <sup>1</sup> / <sub>2</sub> in 216 mm
80-1869	Without Lock	8 <sup>1</sup> / <sub>2</sub> in 216 mm



80-1868

### Jones Ima Needle Holder Classic Plus®

CODE	DESCRIPTION	LENGTH
36-3018	Straight	6 in 152 mm
36-3019	Straight	7 in 178 mm



36-3018

## Needle Holders

### Julian Needle Holder

Jaws Have Tungsten, Carbide Inserts, Use With 5-0 and 6-0 Suture, Ring Handle

CODE	DESCRIPTION	LENGTH
32-475	Straight	8 in 203 mm



### Julian Classic Plus® Needle Holders

Tungsten Carbide Inserts

CODE	DESCRIPTION	LENGTH
36-3042	Straight	8 ¼ in 210 mm
36-3043	Curved	8 ¼ in 210 mm



36-3042

### Masson Needle Holder

Heavy Pattern, Tungsten Carbide Inserts

CODE	DESCRIPTION	LENGTH
32-304	Needle Holder	16 in 406 mm
32-305	Needle Holder	18 in 458 mm

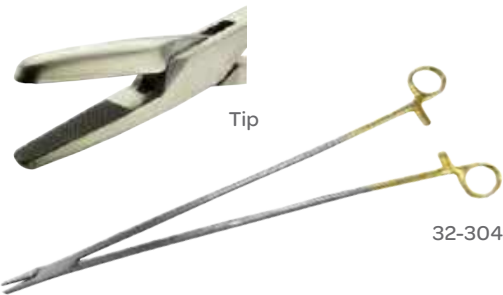

Tip

32-304

### Mathieu Needle Holder

Serrated Jaw, Tungsten Carbide Inserts Use with 2-0 and 3-0 Suture

CODE	DESCRIPTION	LENGTH
32-190	Flat Spring Handle with Lock	7 ½ in 191 mm

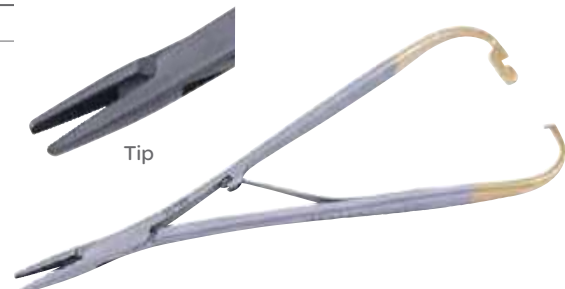

Tip

## Needle Holders

### Mayo-Hegar Needle Holder

Tungsten Carbide Inserts, Use With 1-0, 2-0 Suture

CODE	DESCRIPTION	LENGTH
32-120L	Left Handed Pattern, Ring Handle	6 in 152 mm
32-130L	Left Handed Pattern, Ring Handle	7 in 178 mm
32-140L	Left Handed Pattern, Ring Handle	8 ¼ in 210 mm
32-120	Ring Handle	6 ¼ in 159 mm
32-130	Ring Handle	7 ¼ in 184 mm
32-140	Ring Handle	8 ¼ in 210 mm
32-145	Ring Handle	9 ½ in 241 mm
32-240	Ring Handle	10 ½ in 267 mm
32-300	Ring Handle	11 ⅞ in 302 mm



### Mayo-Hegar Needle Holder

CODE	DESCRIPTION	LENGTH
10-1813		5 ¼ in 133 mm
10-1819	Stubby Jaw	7 in 178 mm



## Needle Holders

### Mayo-Hegar Needle Holder

CODE	DESCRIPTION	LENGTH
36-2015	Tungsten Carbide Jaw Inserts	5 in 127 mm
36-2016	Tungsten Carbide Jaw Inserts	6 in 152 mm
36-2017	Tungsten Carbide Jaw Inserts	7 in 178 mm
36-2018	Tungsten Carbide Jaw Inserts	8 in 203 mm
36-2019	Tungsten Carbide Jaw Inserts	10 in 254 mm
36-2020	Tungsten Carbide Jaw Inserts	12 in 305 mm
32-3686	Tungsten Carbide Insert	14 in 356 mm



36-2015

### Mayo-Hegar Needle Holder

CODE	DESCRIPTION	LENGTH
64-2512	Stainless Steel	6 in 152 mm
10-1815	Stainless Steel	6¼ in 159 mm
64-2513	Stainless Steel	7 in 178 mm
10-1818	Stainless Steel	7¾ in 187 mm
10-1820	Stainless Steel	8 in 203 mm
64-2503	Stainless Steel	8 in 203 mm
10-1823	Stainless Steel	9½ in 241 mm
10-1828	Stainless Steel	14 in 356 mm



64-2503

### Needle Holder

CODE	DESCRIPTION	LENGTH
78-0220	Curved Smooth Jaws, without Lock	6 in 152 mm
80-2012	Straight, 0.5 mm Tip	7 in 178 mm
78-0138	Curved, 0.4 mm, Round Handle without Lock	7 in 178 mm
80-2013	Curved, 0.5 mm Tip	7 in 178 mm
80-1800	Microvascular Needle Holder Titanium	7 in 178 mm

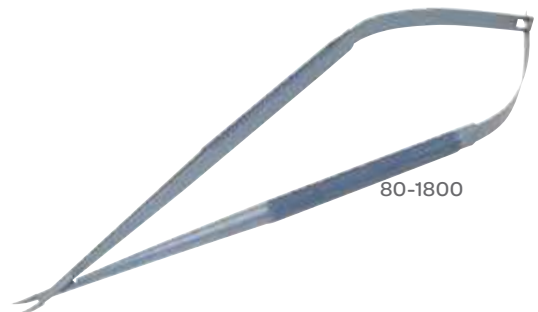

80-1800

## Needle Holders

### Neivert Needle Holder

CODE	DESCRIPTION	LENGTH
10-0812	Offset Ring Handle, Stainless Steel	4 $\frac{7}{8}$ in 124 mm
32-420	Tungsten Carbide Inserts, Use With 5-0, 6-0 Suture Offset Ring Handle	5 in 127 mm



10-0812

### New Orleans Needle Holder

CODE	DESCRIPTION	LENGTH
32-150	Ring Handle	7 in 178 mm
10-1418	Serrated, Ring Handle	7 in 178 mm

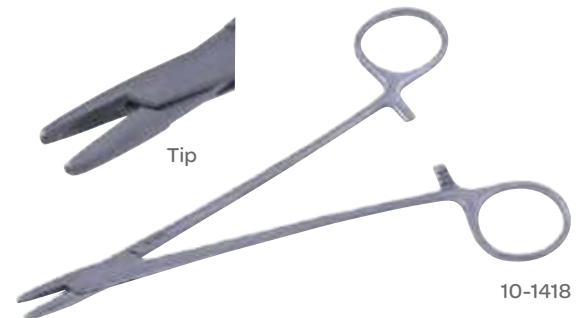

10-1418

### Olsen-Hegar Needle Holder

Combination Needle Holder And Scissors, Use with 3-0 and 4-0 Suture

CODE	DESCRIPTION	LENGTH
32-159	Tungsten Carbide Inserts	5 in 127 mm
32-160	Tungsten Carbide Inserts	5 $\frac{1}{2}$ in 140 mm
32-170	Tungsten Carbide Inserts	5 $\frac{3}{4}$ in 146 mm
32-180	Tungsten Carbide Inserts Ring Handle	7 $\frac{1}{2}$ in 191 mm



32-180



## Needle Holders

### Olsen Hegar Needle Holder

Combination of Needle Holder and Scissors

CODE	DESCRIPTION	LENGTH
36-4000	Tungsten Carbide Jaw Inserts	5½ in 140 mm



### Par Needle Holder

Tungsten Carbide Inserts, Use with 6-0, 7-0 Suture

CODE	DESCRIPTION	LENGTH
32-404	Ring Handle	4¾ in 118 mm



### Rogers Classic Plus® Needle Holder

Tungsten Carbide Inserts

CODE	DESCRIPTION	LENGTH
36-4011	Curved Jaws	10½ in 267 mm



### Rubio Classic Plus® Needle Holder

Tungsten Carbide Jaw Inserts, Tip 1.14 mm, Serrated Jaw

CODE	DESCRIPTION	LENGTH
36-2024	Offset Handles	7⅝ in 194 mm



## Needle Holders

### Ryder Needle Holder

Tungsten Carbide Inserts, Use with 5-0, 6-0 and 7-0 Suture

CODE	DESCRIPTION	TIP	LENGTH
32-465	Serrated Jaw, Ring Handle	1.0 mm	5¼ in 133 mm
32-466	Serrated Jaw, Ring Handle	1.0 mm	6 in 152 mm
32-467	Serrated Jaw, Ring Handle	1.0 mm	7¼ in 184 mm
32-468	Serrated Jaw, Ring Handle	1.0 mm	8 in 203 mm
32-469	Serrated Jaw, Ring Handle	1.0 mm	9 in 229 mm
32-472	Serrated Jaw, Ring Handle	1.0 mm	10¼ in 260 mm
32-467L	Serrated Jaw, Left-Handed	1.0 mm	7 in 178 mm
32-467XL	Serrated Jaw, Extra Large	1.0 mm	12 in 305 mm
32-468S	Smooth Jaw, Ring Handle	1.0 mm	8 in 203 mm



32-465

### Ryder Needle Holder

Jaw Surface with Fine Tungsten Carbide Dust, Use with 6-0, 7-0 and 8-0 Suture

CODE	DESCRIPTION	LENGTH
55-2660	Ring Handle	6½ in 165 mm
55-2662	Ring Handle	7¼ in 184 mm
55-2664	Ring Handle	8½ in 216 mm



55-2660

## Needle Holders

### Ryder Classic Plus® Needle Holder

Serrated Jaw, Tungsten Carbide Jaw Inserts

CODE	JAW WIDTH	TIP SIZE	LENGTH
36-3023	1.0 mm	1.5 mm	5 in 127 mm
36-3014	1.0 mm	1.5 mm	6 in 152 mm
36-3012	1.0 mm	1.5 mm	7 in 178 mm
36-3015	1.0 mm	1.5 mm	8 in 203 mm
36-3013	1.0 mm	1.5 mm	9 in 229 mm
36-3000	2.0 mm	1.5 mm	5 in 127 mm
36-3001	2.0 mm	1.5 mm	6 in 152 mm
36-3002	2.0 mm	1.5 mm	7 in 178 mm
36-3003	2.0 mm	1.5 mm	8 in 203 mm
36-3004	2.0 mm	1.5 mm	9 in 229 mm
36-3005	2.0 mm	1.5 mm	10 in 254 mm



36-3000

### Ryder Classic Plus® Needle Holder

Smooth Jaw, Tungsten Carbide Jaw Inserts

CODE	JAW WIDTH	LENGTH
36-3022	1.0 mm	5 in 127 mm
36-3007	1.0 mm	6 in 152 mm
36-3008	1.0 mm	7 in 178 mm
36-3009	1.0 mm	9 in 229 mm



36-3007

## Needle Holders

### Sarot Needle Holder

Tungsten Carbide Inserts, Ring Handle, Use with 3-0 and 4-0 Suture

CODE	DESCRIPTION	LENGTH
32-340	Serrated Jaw	7 <sup>3</sup> / <sub>8</sub> in 187 mm
32-342	Serrated Jaw	8 in 203 mm
32-344	Serrated Jaw	9 in 229 mm
10-2218	Serrated Jaw, Stainless Steel	7 <sup>1</sup> / <sub>4</sub> in 184 mm



### Sarot Classic Plus® Needle Holder

CODE	DESCRIPTION	LENGTH
36-3020	Tungsten Carbide Jaw Inserts	7 in 178 mm
36-3021	Tungsten Carbide Jaw Inserts	10 in 254 mm



### Spencer Needle Holder

Tungsten Carbide Inserts, Flat Handle

CODE	JAW WIDTH	LENGTH
32-185	0.76 mm	7 <sup>1</sup> / <sub>4</sub> in 184 mm



## Needle Holders

### Stratte Needle Holder

Curved Jaws, Tungsten Carbide Inserts

CODE	DESCRIPTION	LENGTH
32-255	Bent Shanks, Ring Handle	8 ¼ in 210 mm
32-256	Bent Shanks	9 in 229 mm
32-251	Bent Shanks, Curved to the Right	9 in 229 mm

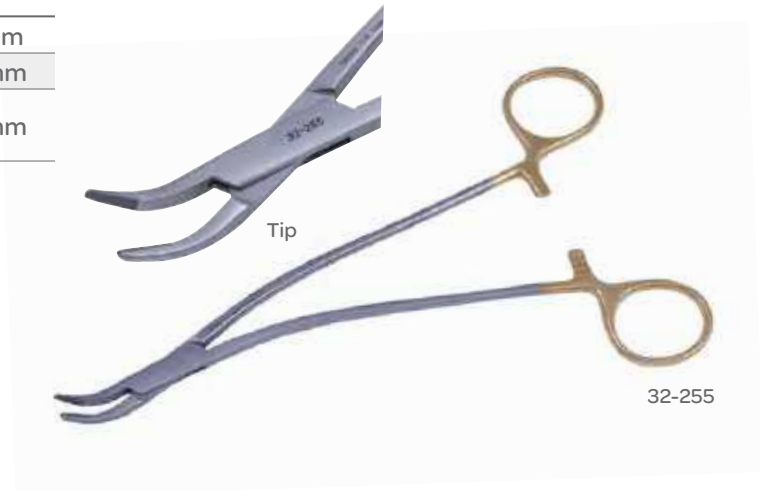

### Stratte Classic Plus® Needle Holder

Tungsten Carbide Inserts

CODE	DESCRIPTION	LENGTH
36-4015	Curved Jaw	9 in 229 mm

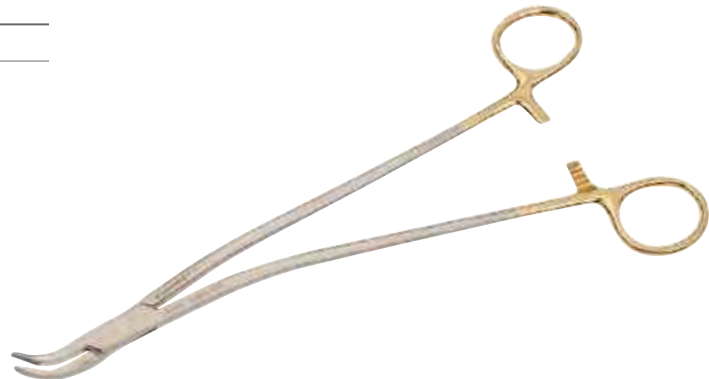

### Sweden Needle Holder

Tungsten Carbide Inserts, Delicate, Ring Handle, Use with 5-0 and 6-0 Suture

CODE	JAWS	LENGTH
32-460	1.5 x 8.0 mm	6 ¾ in 171 mm

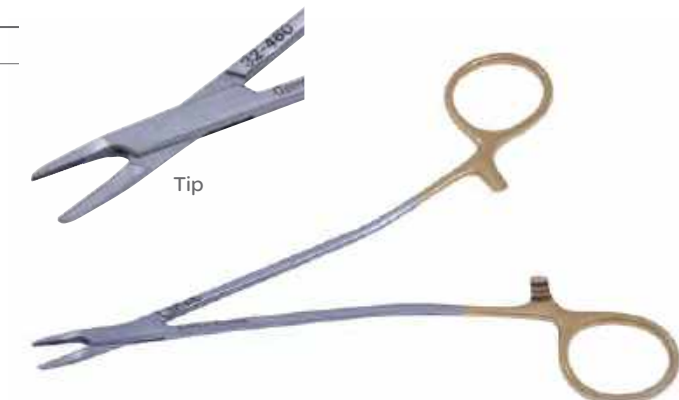

## Needle Holders

### Total Occlusion Needle Holder

Tungsten Carbide Inserts

CODE	DESCRIPTION	LENGTH
37-4029	Smooth Jaw	4 ¾ in 121 mm



### Wangensteen Classic Plus® Needle Holder

CODE	DESCRIPTION	LENGTH
36-4020	Tungsten Carbide Jaw Inserts	10 ½ in 267 mm



### Webster Needle Holder

Ring Handle, Use with 4-0, 5-0, 6-0 Suture

CODE	DESCRIPTION	LENGTH
32-405	Fine Tungsten Carbide Inserts,	4 ½ in 114 mm
32-405L	Fine Tungsten Carbide Inserts, Left Handed	4 ½ in 114 mm



### Webster Needle Holder

Ring Handle

CODE	DESCRIPTION	LENGTH
10-1012	Smooth Jaws, Non-Tungsten	5 in 127 mm



## Needles

### Heparin Needle

CODE	DESCRIPTION	LENGTH
54-6016	Medium Tip, 3.7 mm	2 1/8 in 55 mm



### Webster Infusion Needle

CODE	DESCRIPTION	LENGTH
09-5011	Straight	2 7/16 in 62 mm
09-5012	Curved	2 3/8 in 60 mm



09-5012

### Heparin Needle

CODE	DESCRIPTION	LENGTH
54-6000	Olive Tip, 2.9 mm	2 in 51 mm



### Reverdin Needle

CODE	DESCRIPTION	LENGTH
13-6101	#1	7 1/2 in 191 mm
13-6102	#2	7 1/2 in 191 mm
13-6103	#3	7 1/2 in 191 mm
13-6104	#4	7 1/2 in 191 mm
13-6201	#1	8 1/4 in 210 mm
13-6202	#2	8 1/4 in 210 mm
13-6203	#3	8 1/4 in 210 mm
13-6204	#4	8 1/4 in 210 mm



13-6101

## Pin Wheels

### Wartenberg Pin Wheel

CODE	LENGTH
44-3025	7¼ in 184 mm



## Pliers

### Heavy Duty Lock Pliers

CODE	DESCRIPTION	LENGTH
37-4101	Vice Grips	7 in 178 mm
32-3337	Tip Width 0.9 cm	8 in 203 mm



### Needle Nose Pliers

CODE	DESCRIPTION	LENGTH
32-3339	Wire Notch	5½ in 140 mm





# Pliers

## Needle Nose Pliers

CODE	DESCRIPTION	LENGTH
37-4100	Serrated Jaws	6¼ in 159 mm



## Pliers

CODE	DESCRIPTION	LENGTH
14-4600	Flat Nose Pliers, 2.0 mm Tip	6 in 152 mm

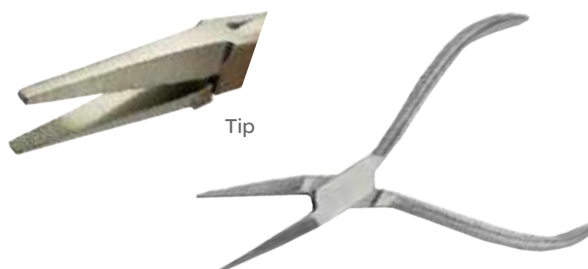

## Pliers

CODE	DESCRIPTION	LENGTH
14-5000	Slip Joint Pliers	6 in 152 mm



## Pliers

CODE	DESCRIPTION	LENGTH
14-5620	Parallel Pliers	7 in 175 mm



## Probes

### Excavator & Probe

CODE	DESCRIPTION	LENGTH
43-8501	Double-Ended	6 in 152 mm



### Double-Ended Probe

2.0 mm Diameter on Tip

CODE	DESCRIPTION	LENGTH
09-0514	Stainless Steel	5 3/4 in 146 mm
09-0515	Stainless Steel	6 in 152 mm
09-0520	Stainless Steel	8 in 203 mm



### Grooved Director & Tounge Tie Probe

2.0 mm Diameter on Tip

CODE	DESCRIPTION	LENGTH
09-1512	Stainless Steel	4 1/2 in 114 mm
09-1513	Stainless Steel	5 1/8 in 130 mm
09-1514	Stainless Steel	5 3/4 in 146 mm
09-1516	Stainless Steel	6 1/4 in 159 mm
09-1613	Stainless Steel, Probe End	5 1/8 in 130 mm
09-1614	Stainless Steel, Probe End	5 3/4 in 146 mm



## Probes

### Probe with Eye

CODE	DESCRIPTION	LENGTH
49-4030	Stainless Steel	4 ½ in 114 mm
49-4031	Stainless Steel	5 in 127 mm
49-4032	Stainless Steel	5 ½ in 140 mm
49-4033	Stainless Steel	6 in 152 mm
49-4035	Stainless Steel	8 in 203 mm
49-4037	Stainless Steel	10 in 254 mm



49-4030

### Bowman Lacrimal Probe

Double-Ended, Malleable, Silver

CODE	DESCRIPTION	LENGTH
49-6500	0000-000	4 7/8 in 118 mm
49-6501	00-0	4 7/8 in 118 mm
49-6502	1-2	4 7/8 in 118 mm
49-6503	3-4	4 7/8 in 118 mm
49-6504	5-6	4 7/8 in 118 mm
49-6505	7-8	4 7/8 in 118 mm



49-6503

### Probe

CODE	DESCRIPTION	LENGTH
09-1113	Stainless Steel	5 ½ in 130 mm
09-1114	Stainless Steel	5 ½ in 140 mm
09-1115	Stainless Steel	6 in 152 mm
09-1120	Stainless Steel	8 in 203 mm



09-1113

## Punches (Dermal Punch)

### Keyes Dermal Punch

CODE	DESCRIPTION	LENGTH
43-0302	2.0 mm	3 ¾ in 95 mm
43-0303	3.0 mm	3 ¾ in 95 mm
43-0304	4.0 mm	3 ¾ in 95 mm
43-0305	5.0 mm	3 ¾ in 95 mm
43-0306	6.0 mm	3 ¾ in 95 mm
43-0307	7.0 mm	3 ¾ in 95 mm
43-0308	8.0 mm	3 ¾ in 95 mm

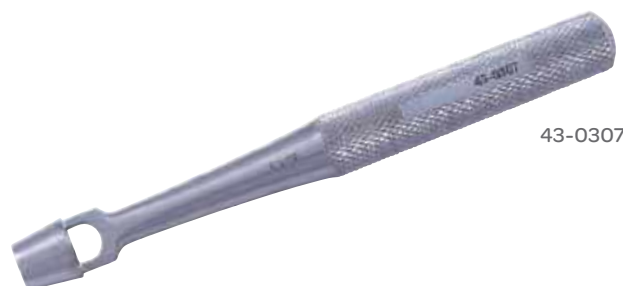

43-0307

## Raspatories

### Joseph Periosteal Raspatory

CODE	DESCRIPTION	TIP WIDTH	WORKING DISTANCE	LENGTH
52-1005	Sharp	¼ in 6.0 mm	1 ⅝ in 41 mm	6 ⅞ in 175 mm



## Retractors (Abdominal)



24-5200A

### Balfour Abdominal Retractor

Includes Two Pairs of Lateral "Snap On" Wire Blades 2 ½ in and 3 ½ in Deep, 24-5012B Center Blade

CODE	DESCRIPTION	MAXIMUM SPREAD	SIDE BLADE DEPTH
24-5200A	Complete, Snap on Lateral Blades	10 ½ in 267 mm	2 ½ in 64 mm
24-5200AA	Complete, Snap on Lateral Blades	14 in 356 mm	2 ½ in 64 mm
24-5200AAA	Complete, Snap on Lateral Blades	16 in 405 mm	3 ½ in 90 mm
24-7015	Complete, Fixed Blades 4 in deep, with Center Blade	7 ⅞ in 181 mm	4 in 102 mm
24-7017	Complete, Fixed Blades 4 in deep, with Center Blade	10 in 254 mm	4 in 102 mm



24-5201

### Balfour Retractor Snap-On Lateral Blades

CODE	DESCRIPTION	DEPTH
24-5201	Wire	2 ½ in 63 mm
24-5204	Solid	4 in 102 mm

## Retractors (Abdominal)



### Balfour Fenestrated Retractor

With 2 Lateral Blades and 1 Center Blade

CODE	TOTAL OPENING		LATERAL BLADE (W X D)		CENTER BLADE (W X D)	
50-4500	7 in	178 mm	1 ¼ x 2 in	32 x 51 mm	3 x 2 in	76 x 51 mm



### Balfour Retractor Complete

Self-Retaining with Ratchet Crossbar

CODE	COMPLETE TOTAL OPENING		LATERAL BLADES (W X D)		CENTER BLADE (W X D)	
50-4514	7 in	178 mm	1 ½ x 2 ¼ in (38 x 57 mm)	1 ½ x 3 ¼ in (38 x 83 mm)	¾ x 2 ¼ in (83 x 57 mm)	2 ½ x 2 ½ in (64 x 64 mm)

## Retractors (Abdominal)

### Balfour Retractor Blade

CODE	DESCRIPTION	LENGTH (W X D)	CODE	DESCRIPTION	LENGTH (W X D)
24-5012B	Standard Blade	2½ x 1¾ in (64 x 44 mm)	24-5022B	Supra-Pubic Blade	2¾ x 2⅝ in (70 x 67 mm)
24-5014B	Standard Blade	3⅝ x 1¾ in (92 x 44 mm)	24-5024B	Supra-Pubic Blade	3⅜ x 2¾ in (86 x 70 mm)



### Balfour Retractor Blade

CODE	DESCRIPTION
24-5060C	Center Blade Attachment, with Wing Nut



### Balfour Retractor Blade

CODE	DESCRIPTION	LENGTH (W X D)
24-7071	Center Blade	2½ x 1½ in 64 x 38 mm
24-7072	Center Blade	3 x 2 in 76 x 51 mm
24-7073	Center Blade	3⅝ x 2½ in 86 x 64 mm
24-7074	Center Blade	3⅞ x 2⅞ in 79 x 73 mm
24-5032B	Center Blade	2½ x 3½ in 64 x 89 mm
24-7075	Center Blade	2¾ x 4 in 70 x 102 mm



## Retractors (Abdominal)

### Balfour Retractor Blade

CODE	DESCRIPTION	LENGTH (W X D)
24-7085	Horgan Center Blade, Malleable	2x5 in 51x127 mm



### Balfour Retractor Blade

CODE	DESCRIPTION	LENGTH (W X D)
24-5036B	Horgan Blade, Malleable	2½ x 6½ in 64 x 165 mm



### Horgan Retractor Blade

CODE	DESCRIPTION	BLADE LENGTH	LENGTH
50-4524	Center Blade	7¾ in 197 mm	14¾ in 375 mm



### Balfour Retractor Blade

CODE	DESCRIPTION	LENGTH (W X D)
24-5028B	Narrow Blade	1⅝ x 3½ in 41 x 89 mm



## Retractors (Abdominal)

### Balfour Fenestrated Retractor

One Pair, Use with 50-4503 and 50-4509

CODE	DESCRIPTION	DEPTH
50-4505	Lateral Blade	3 ½ in 89 mm
50-4506	Lateral Blade	4 in 102 mm



### Balfour Retractor Fourth Arm Attachment

Without Blade

CODE	DESCRIPTION	LENGTH
24-5062L	Left	12 in 305 mm
50-4526	Left	12 in 305 mm
50-4527	Right	12 in 305 mm



### Balfour Retractor Blade

CODE	DESCRIPTION
24-5062C	Clamp for Balfour Fourth Blade Attachment, with Wing Nut



## Retractors (Abdominal)



### Baby Balfour Retractor

Abdominal Retractor, Miniature Model, Self-Retaining With Fixed Lateral Fenestrated Blades And One Center Blade

CODE	TOTAL OPENING		ARM LENGTH		LATERAL BLADE		CENTER BLADE	
50-5651	3 <sup>3</sup> / <sub>4</sub> in	95 mm	3 <sup>3</sup> / <sub>4</sub> in	95 mm	1 x 1 in	25 x 25 mm	1 x 1 in	25 x 25 mm

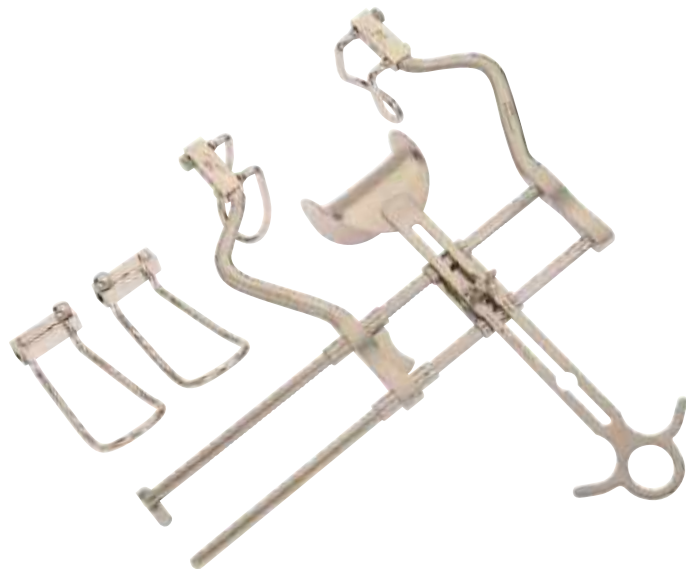

### Balfour Retractor with Fenestrated Blades

Abdominal Retractor, Self-Retaining with Trigger Ratchet. Includes Two Pair Of Detachable Lateral Fenestrated Blades And One Center Blade

CODE	TOTAL OPENING		LATERAL BLADES (W X D)		CENTER BLADE (W X D)		TOTAL WIDTH	
50-4503	7 <sup>5</sup> / <sub>8</sub> in	194 mm	1 <sup>3</sup> / <sub>4</sub> x 2 <sup>1</sup> / <sub>2</sub> in	44 x 64 mm	2 <sup>1</sup> / <sub>2</sub> x 2 <sup>1</sup> / <sub>2</sub> in	64 x 64 mm	7 <sup>5</sup> / <sub>8</sub>	194 mm
			1 <sup>3</sup> / <sub>4</sub> x 3 <sup>3</sup> / <sub>8</sub> in	44 x 86 mm				

## Retractors (Abdominal)



### Balfour Retractor with Fenestrated Blades

Abdominal Retractor, Self-Retaining. With Two Fixed Blades, Two Removable Small Blades And One Large Removable Blade

CODE	TOTAL OPENING	LATERAL BLADE (W X D)	CENTER BLADE (W X D)
50-4510	8½ in 216 mm	1½ x 2½ in 38 x 64 mm	2½ x 2½ in 64 x 64 mm



### B.E. Glass Abdominal Retractor

CODE	DIMENSIONS (W X D)	LENGTH
24-3380	6 x 3¼ in 153 x 83 mm	9¾ in 248 mm



### O'Connor-O'Sullivan Abdominal Retractor

Abdominal Retractor, self-retaining. Includes two fixed blades, two removable small blades and one large removable blade.

CODE	DESCRIPTION	SMALL BLADE (W X D)	FIXED BLADE (W X D)	LARGE BLADE
50-4400	Self-Retaining	1¾ x 3¼ in (44 x 83 mm)	1 x 2 in (25 x 51 mm) Opening: 5½ in (140 mm)	4 in (102 mm) Opening: 6½ in (159 mm)

## Retractors (Abdominal)

### O'Connor-O'Sullivan Abdominal Retractor

CODE	DESCRIPTION	LENGTH	
24-8500	Complete Set (24-8509, 24-8511, 24-8512)		
24-8509	Frame Only, with 2 Rotatable Lateral Blades Attached	1 x 2½ in	25 x 60 mm
24-8511	Center Blade, 2/Each Included in 24-8500	1¾ x 3¼ in	44 x 83 mm
24-8512	Center Blade, 1/Each Included in 24-8500	2¾ x 4⅛ in	70 x 105 mm
24-8599	Wing Nuts (Pair)		



## Retractors (Bookwalter® Horizontal Bars)

### Bookwalter® Gooseneck Horizontal Bar

CODE	DESCRIPTION	LENGTH
50-4681	Gooseneck Table Post for 1 in (25 mm) System, Includes Built In Coupler. For Use with 50-4680	



## Retractors (Bookwalter® Horizontal Bars)

### Bookwalter® Lightweight Horizontal Bar

CODE	DESCRIPTION	LENGTH
50-4552	Horizontal Bar	14 ¼ in 362 mm



### Bookwalter® Lightweight Horizontal Flexbar

CODE	DESCRIPTION
50-4582	Horizontal Flexbar with 360° Rotation



### Bookwalter® Ironman Horizontal Ring Holder

CODE	DESCRIPTION
50-4678	Horizontal Bar with incorporated Coupler for added adjustability



## Retractors (Bookwalter® Horizontal Bars)

### Bookwalter® Lightweight Horizontal Bar

CODE	DESCRIPTION
50-4618	Bookwalter® Lightweight Horizontal Bar 50-4618 Horizontal Bar, Lightweight design that can be back fed into the Bookwalter® Coupler.

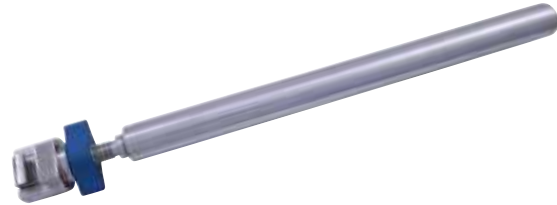

### Bookwalter® Lightweight Extension Bar

CODE	LENGTH
50-4553	12 in 305 mm
50-4797	18 in 458 mm

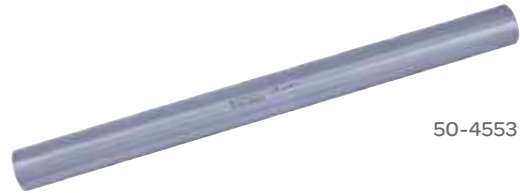

50-4553

## Retractors (Bookwalter® Blades)

### Bookwalter® Balfour Blade

CODE	WIDTH	DEPTH
50-4576	2 5/8 in 67 mm	3 in 76 mm
BW1271017	3 1/2 in 89 mm	2 3/4 in 70 mm



50-4576

### Bookwalter® Gelpi Blade

CODE	DESCRIPTION
50-4577	Sharp Tip



## Retractors (Bookwalter® Blades)

### Bookwalter® Harrington Blade

CODE	DESCRIPTION	WIDTH		DEPTH	
50-4566	Harrington Blade	2½ in	63 mm	5⅝ in	143 mm
BW1045176	Harrington Blade	3½ in	88 mm	10 in	253 mm



50-4566

### Bookwalter® Kelly Blade

CODE	DESCRIPTION	WIDTH		DEPTH	
50-4574	Kelly Blade	1 in	25 mm	1 in	25 mm
50-4575	Kelly Blade	1 in	25 mm	2½ in	64 mm
50-4565	Kelly Blade	2 in	51 mm	1½ in	38 mm
50-4563	Kelly Blade	2 in	51 mm	2 in	51 mm
50-4572	Kelly Blade	2 in	51 mm	2½ in	64 mm
50-4568	Kelly Blade	2 in	51 mm	3 in	76 mm
50-4569	Kelly Blade	2 in	51 mm	4 in	102 mm
50-4570	Kelly Blade	2 in	51 mm	5 in	127 mm
50-4571	Kelly Blade	2 in	51 mm	6 in	152 mm
BW1045000	Kelly Blade	2 in	51 mm	8 in	203 mm



50-4568

### Bookwalter® Rake Retractor

Sharp Teeth

CODE	DESCRIPTION	WIDTH		DEPTH	
50-4644	3 Prongs	⅔ in	17 mm	¾ in	19 mm
50-4645	4 Prongs	¾ in	19 mm	⅓ in	8.4 mm
50-4646	5 Prongs	1 in	25 mm	⅓ in	8.4 mm



50-4644

## Retractors (Bookwalter® Blades)

### Bookwalter® Richardson Blade

CODE	WIDTH X LENGTH
50-4597	$\frac{3}{4}$ x 1 in 19 x 25 mm
50-4598	$\frac{3}{4}$ x 2 in 19 x 51 mm
50-4599	1 x $\frac{1}{4}$ 25 x 32 mm



### Bookwalter® Scoville Hook

CODE	DESCRIPTION	DEPTH
50-4640	Small	2 in 51 mm
50-4639	Large	$3\frac{1}{4}$ in 83 mm



### Bookwalter® -Meyerding Retractor Blade

Small Sharp Teeth

CODE	DESCRIPTION	DIMENSIONS
50-4641	Small	$\frac{2}{3}$ x $2\frac{1}{3}$ in 17 x 60 mm
50-4642	Medium	1 x $3\frac{1}{3}$ in 25 x 85 mm
50-4643	Large	2 x $3\frac{3}{4}$ in 51 x 95 mm

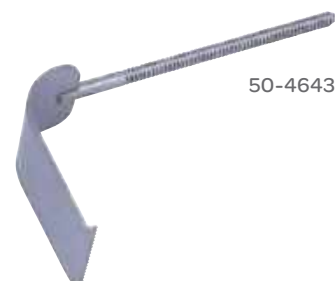

### Bookwalter® Opti-Length® Retractor Blade

Ebonized

CODE	DESCRIPTION	WIDTH X LENGTH
67-7502	Malleable with Lip	$1\frac{1}{2}$ x 11 in 38 x 279 mm
67-7504	Malleable with Lip	2 x 11 in 51 x 279 mm
67-7499	Malleable with Lip	3 x 11 in 76 x 279 mm
67-7500	Malleable with Lip	4 x 11 in 102 x 279 mm



## Retractors (Bookwalter® Blades)

### Bookwalter® Malleable Retractor Blade

Stainless Steel Matte Finish

CODE	WIDTH X LENGTH	
50-4561	2 x 6 in	51 x 152 mm
50-4562	1½ x 6 in	38 x 152 mm
50-4567	3 x 6 in	76 x 152 mm
BW1043016	2 x 10 in	51 x 254 mm
BW1043029	3 x 10 in	76 x 254 mm
BW1045069	4 x 8 in	101 x 203 mm



50-4561

### Bookwalter® Malleable Blade With Lip

CODE	DESCRIPTION	WIDTH X LENGTH	
50-4694	Small	1 x 4 in	25 x 102 mm
50-4672	Medium	1½ x 6 in	38 x 152 mm
50-4673	Large	2 x 6 in	51 x 152 mm
50-4674	X-Large	3 x 6 in	76 x 152 mm



50-4673

### Bookwalter® Retractor Blade

CODE	DESCRIPTION	WIDTH X LENGTH	
50-4669	Small	1½ x 6 in	38 x 152 mm
50-4670	Medium	2 x 6 in	51 x 152 mm
50-4671	Large	2 x 6 in	76 x 152 mm



50-4669

### Bookwalter®-Magrina Retractor Blade

CODE	DESCRIPTION	WIDTH X LENGTH	
50-4691	Malleable with Lip	1 x 4 in	25 x 102 mm





## Retractors (Bookwalter® Blade)

### Bookwalter® Radiolucent Titanium Blade

Low Glare Gold Coating

CODE	DESCRIPTION	WIDTH X LENGTH	
505580	Titanium Blade	1 x 4 in	25 x 102 mm
505581	Titanium Blade	1 x 5 in	25 x 127 mm
505582	Titanium Blade	1 x 6 in	25 x 152 mm
505583	Titanium Blade	1 x 7 in	25 x 178 mm
505584	Titanium Blade	1 x 8 in	25 x 203 mm
505585	Titanium Blade	2 x 4 in	51 x 102 mm
505586	Titanium Blade	2 x 5 in	51 x 127 mm
505587	Titanium Blade	2 x 6 in	51 x 152 mm
505588	Titanium Blade	2 x 7 in	51 x 178 mm
505589	Titanium Blade	2 x 8 in	51 x 203 mm



505581

### Bookwalter® Lightweight Post Coupling

CODE	DESCRIPTION	LENGTH	
50-4554	Malleable with Lip	1 x 1 in	25 x 25 mm



## Retractors (Bookwalter® Kits)

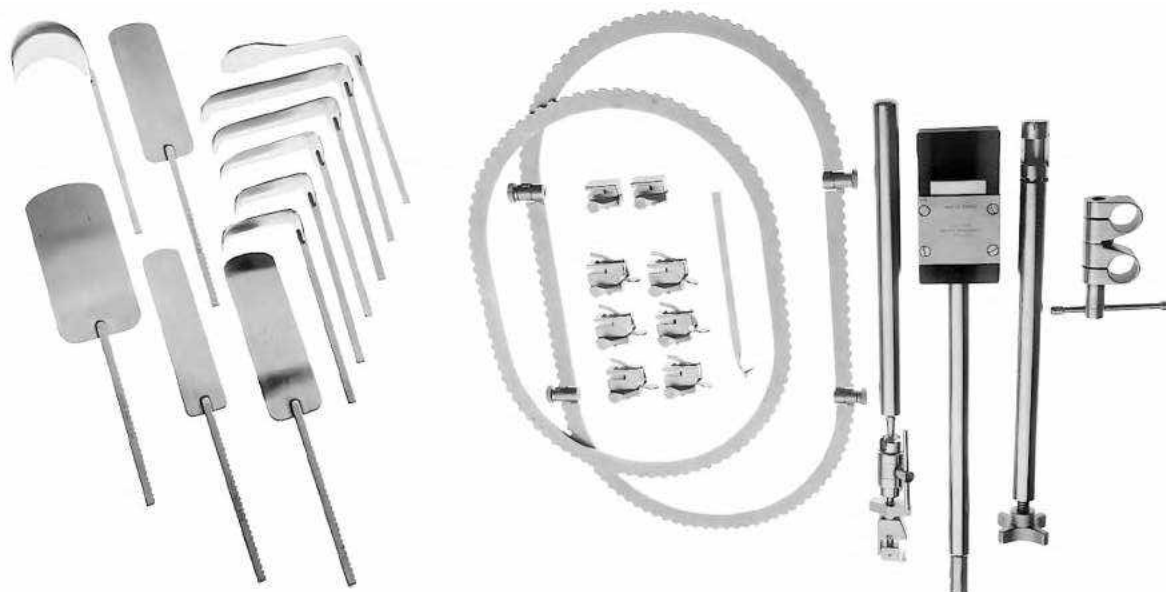

### Bookwalter® Retractor Kit II

CODE	DESCRIPTION	QUANTITY
50-4542	Includes Part Numbers and Quantities Listed Below:	
50-4581	Table Post	1
50-4554	Post Coupling	1
50-4552	Horizontal Bar	1
50-4582	Horizontal Flex Bar	1
50-4557	Medium Oval Ring	1
50-4583	Segmented Ring	1
50-4579	Ratchet Mechanisms	2
50-4580	Tilt Ratchet Mechanisms	6
50-4579	Ratchet Mechanisms	2
50-4580	Tilt Ratchet Mechanisms	6
50-4566	Harrington Retractor	1
50-4576	Balfour Retractor	1
50-4568	Kelly Retractors, 2 x 3 in (51 x 76 mm)	2
50-4569	Kelly Retractor, 2 x 4 in (51 x 102 mm)	1
50-4570	Kelly Retractor 2 x 5 in (51 x 127 mm)	1
50-4571	Kelly Retractor 2 x 6 in (51 x 152 mm)	1
50-4562	Malleable Retractor 1 ½ x 6 in (38 x 152 mm)	1
50-4561	Malleable Retractors, 2 x 6 in (51 x 152 mm)	2
50-4567	Malleable Retractor 3 x 6 in (76 x 152 mm)	1
50-4577	Gelpi Retractor	1
<b>ACCESSORIES</b>		
50-4507	Table Fixation & Ring Case	1
50-4508	Blade & Accessories Case	1

## Retractors (Bookwalter® Kits)

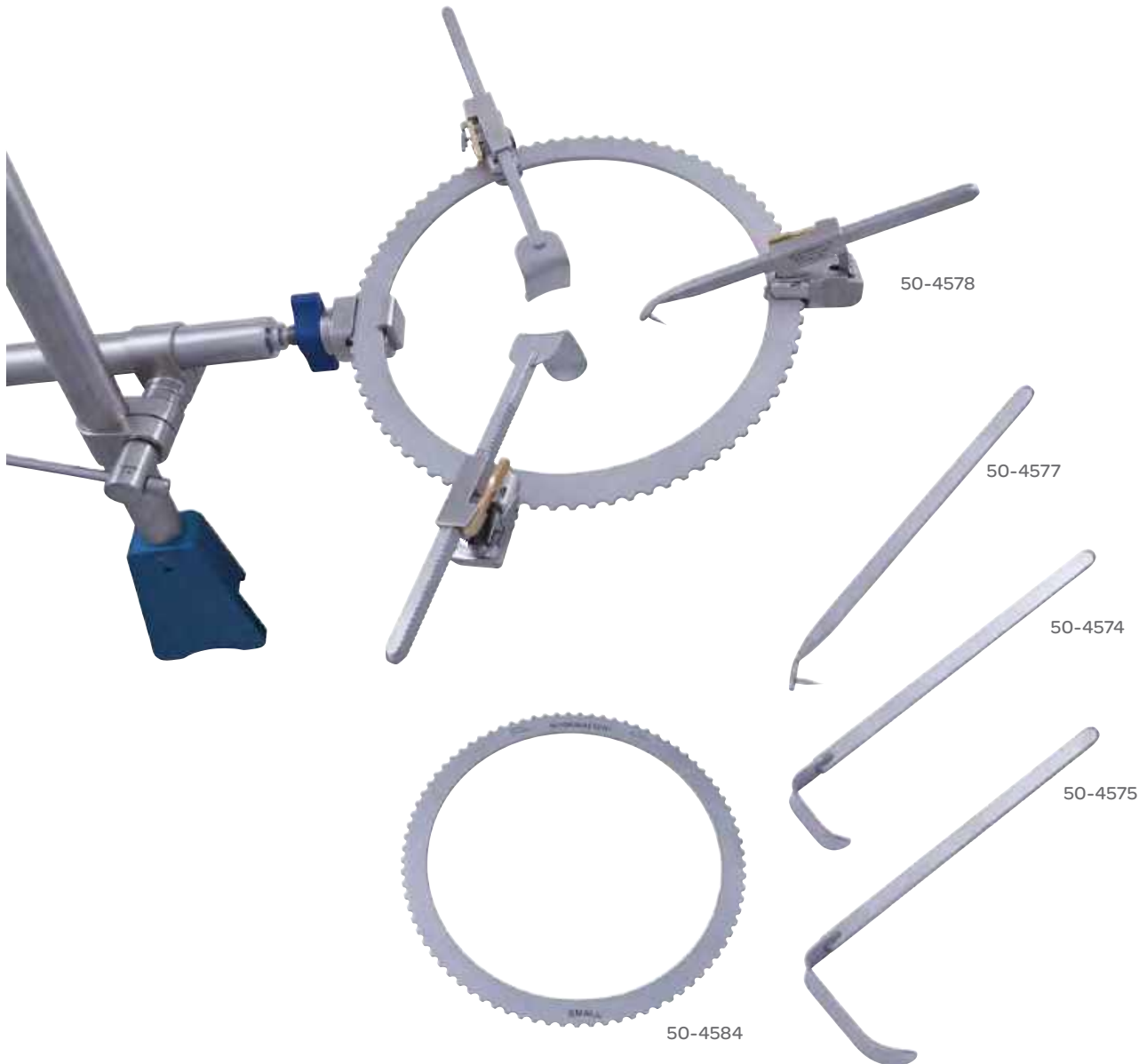

### Bookwalter® Small Incision Kit

CODE	DESCRIPTION	LENGTH
50-4578	Includes Part Numbers Below:	
50-4584	Round Ring	8½ in 216 mm
50-4577	Retractor Gelpi Blade	
50-4574	Kelly Retractor Blades	1x1½ in 25x38 mm
50-4575	Kelly Blade	1x2½ in 25x64 mm

Note: Bookwalter® Small Incision Kit, does not include: Bookwalter® Table Post, Bookwalter® Coupler, Bookwalter® Horizontal Bar or Bookwalter® Ratchets.

## Retractors (Bookwalter® Kits)

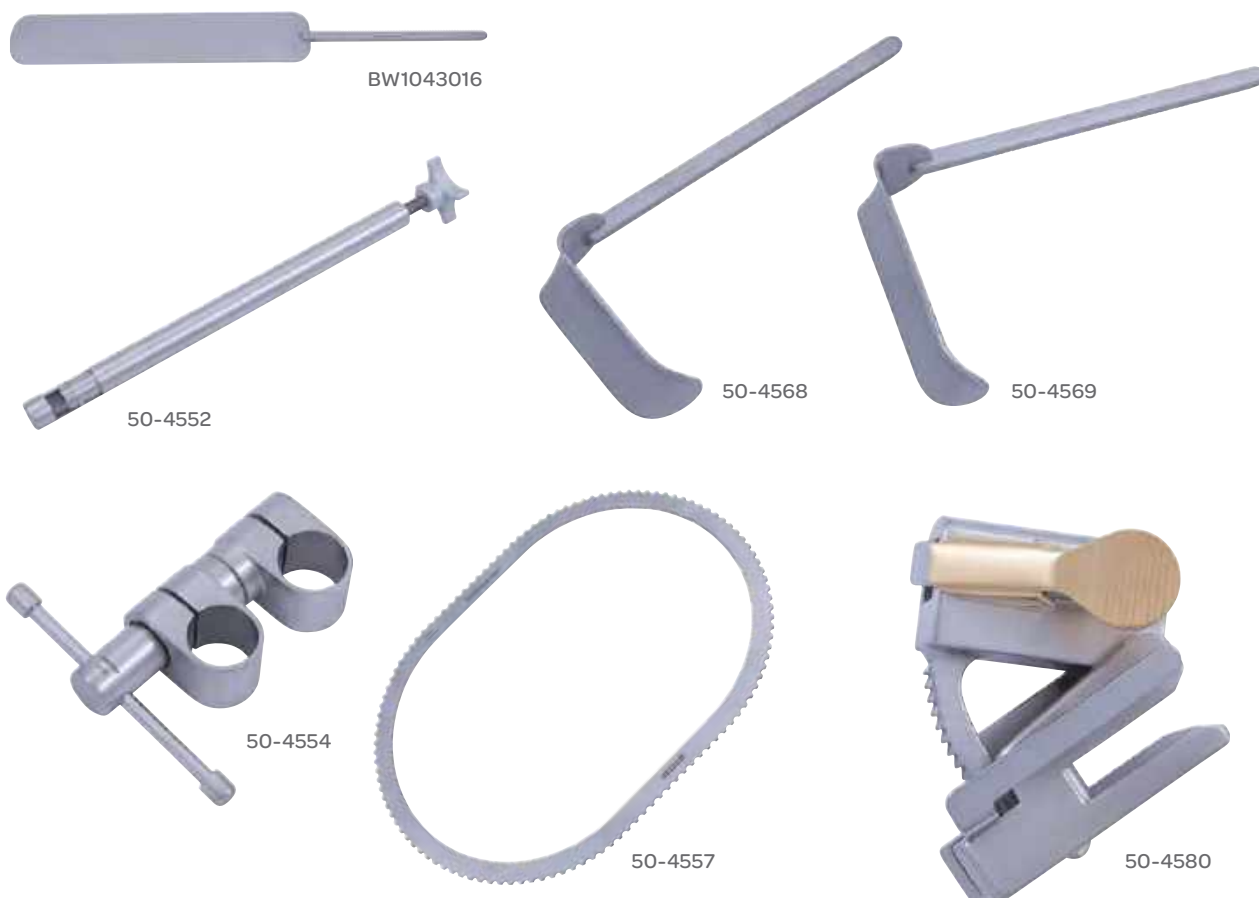

### Bookwalter® Obese Patient Retractor System, 18 Inch (258 mm) Table Post

CODE	DESCRIPTION	LENGTH	QUANTITY
BW1046BKIT	Includes Part Numbers Listed Below:		
BW0144005	Table Post Obese Patients		1
BW1043016	Malleable Blade	2 x 10 in 51 x 254 mm	1
BW1043029	Malleable Blade	3 x 10 in 76 x 254 mm	1
BW1045069	Malleable Blade	4 x 8 in 102 x 203 mm	1
BW1045000	Kelly Blade	2 x 8 in 51 x 203 mm	1
BW1271017	Balfour Blade	3 1/2 x 2 3/4 in 89 x 70 mm	1
BW1045176	Harrington Blade	3 1/2 x 10 in 89 x 254 mm	1
BW0338014	Ratchet Extender		1
BW0338015	Twister Ratchet		1
50-4552	Retractor Horizontal Bar		1
50-4554	Post Coupling	1 x 1 in 25 x 25 mm	1
50-4557	Retractor, Oval Ring Medium		1
50-4568	Kelly Retractor Blades	2 x 3 in 51 x 76 mm	1
50-4569	Kelly Retractor Blades	2 x 4 in 51 x 102 mm	1
50-4580	Tilting Ratchets		6

## Retractors (Bookwalter® Kits)

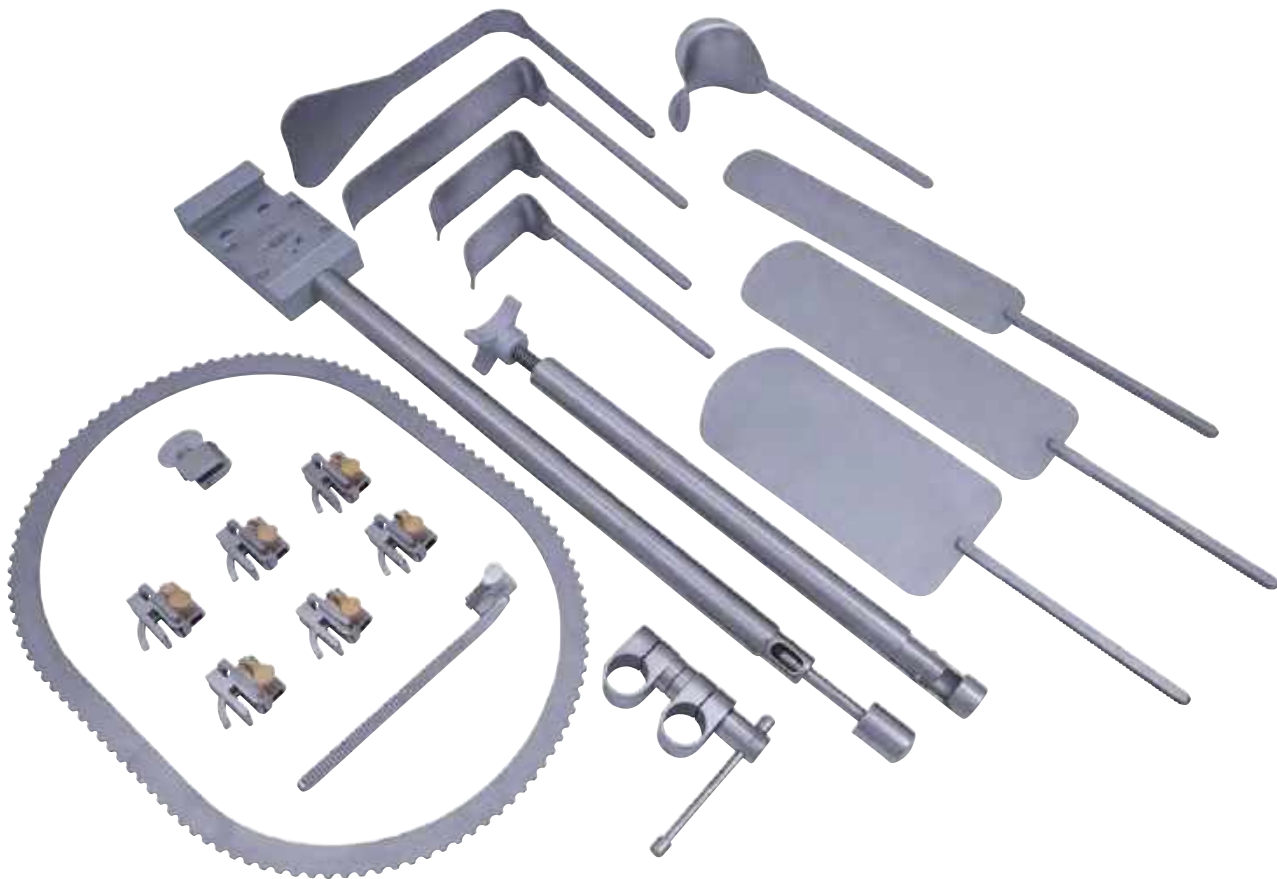

### Bookwalter® Obese Patient Retractor System, 24 Inch (610 mm) Table Post

CODE	DESCRIPTION	LENGTH	QUANTITY
BW1045BKIT	Includes Part Numbers Listed Below:		
BW0144003	Table Post		1
BW1043016	Malleable Blade	2 x 10 in 51 x 254 mm	1
BW1043029	Malleable Blade	3 x 10 in 76 x 254 mm	1
BW1045069	Malleable Blade	4 x 8 in 102 x 203 mm	1
BW1045000	Kelly Blade	2 x 8 in 51 x 203 mm	1
BW1271017	Balfour Blade	3 ½ x 2 ¾ in 89 x 70 mm	1
BW1045176	Harrington Blade	3 ½ x 10 in 89 x 254 mm	1
BW0338014	Ratchet Extender		1
BW0338015	Twister Ratchet		1
50-4552	Horizontal Bar		1
50-4554	Post Coupling	1 x 1 in 25 x 25 mm	1
50-4557	Medium Oval Ring		1
50-4568	Kelly Blade	2 x 3 in 51 x 76 mm	1
50-4569	Kelly Blade	2 x 4 in 51 x 102 mm	1
50-4580	Tilt Ratchets		6

## Retractors (Bookwalter® Kits)



### Bookwalter® Obese Patient Accessory Kit, 18 Inch (458 mm) Table Post

CODE	DESCRIPTION	LENGTH		QUANTITY
BW1046BRT	Includes Part Numbers Listed Below:			
BW0144005	Table Post	18 in	460 mm	1
BW1043016	Malleable Blade	2 x 10 in	51 x 254 mm	1
BW1043029	Malleable Blade	3 x 10 in	76 x 254 mm	1
BW1045069	Malleable Blade	4 x 8 in	102 x 203 mm	1
BW1045000	Kelly Blade	2 x 8 in	51 x 203 mm	1
BW1271017	Balfour Blade	3 ½ x 2 ¾ in	89 x 70 mm	1
BW1045176	Harrington Blade	3 ½ x 10 in	89 x 254 mm	1
BW0338014	Ratchet Extender			1
BW0338015	Twister Ratchet			1



50-4596

### Bookwalter® Richardson Blade Kit

CODE	DESCRIPTION	LENGTH	
50-4596	Includes 1 each of the following:		
50-4597	Blade	¾ x 1 in	19 x 25 mm
50-4598	Blade	¾ x 2 in	19 x 50 mm
50-4599	Blade	1 x 1 ¼ in	25 x 31 mm

## Retractors (Bookwalter® Ratchets)

### Bookwalter® Ratchet Mechanism

CODE	DESCRIPTION	QTY
50-4579	Basic Ratchet provides simple retraction at 0° angle to the surgical site.	1/Each Sold Individually



### Bookwalter® Tilt Ratchet Mechanism

CODE	DESCRIPTION	QTY
50-4580	Tilt ratchet articulates the blade into the surgical site.	1/Each Sold Individually





## Retractors (Bookwalter® Ratchets)

### Bookwalter Rotilt® Ratchet

CODE	DESCRIPTION	QTY
50-4589	The RoTilt Ratchet twists the blade in 7 indexed positions along a 60° arch and has the ability to independently articulate the blade into the surgical site.	1/Each Sold Individually



### Bookwalter® Self-Retaining Tilt Ratchet

CODE	DESCRIPTION	QTY
50-4686	Like the 50-4580 this ratchet articulates the blade into the surgical site, it also has an additional self-retention latch that holds the ratchet onto the Bookwalter® Retractor Ring.	1/Each Sold Individually



### Bookwalter® Self-Retaining Low Profile Locking Rotilt

CODE	DESCRIPTION	LENGTH
50-4696	The Bookwalter® Self-Retaining Low Profile Locking RoTilt Ratchet bring all of the best features of all other ratchets into one mechanism. The low profile design, inclusive of the capacity to tilt, rotate and self-retention it is the one ratchet to build your Bookwalter® Set.	1/Each Sold Individually





## Retractors (Bookwalter® Ratchets)

### Bookwalter® Twister Ratchet

CODE	DESCRIPTION
BW0338015	The Bookwalter® Twister Ratchet is compatible with all Bookwalter® Ratchets and Retractor Blades. It allows controlled fine tuning of blade position with the simple turn of the key.



### Bookwalter® Ratchet Extender

CODE	DESCRIPTION
BW0338014	A Bookwalter® Extender provides the surgeon with the extra length that is sometimes needed to get a blade positioned in 'just the right spot'.  Can be used with any Bookwalter® Retractor.

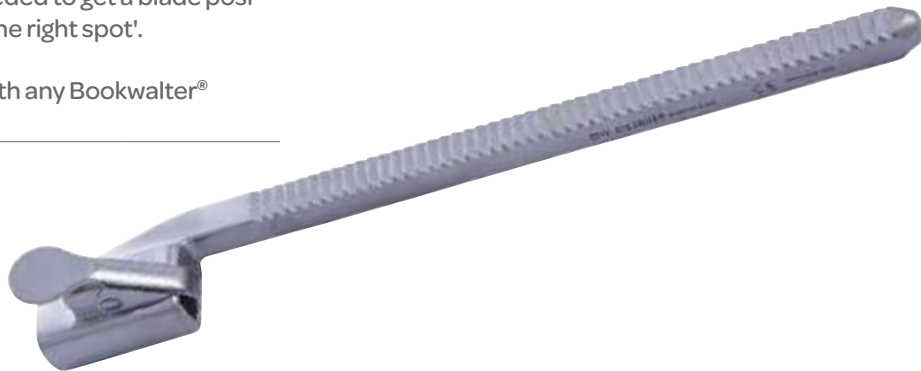

## Retractors (Bookwalter® Rings)

### Bookwalter® Adaptable Ring System Kit

CODE	DESCRIPTION
504810	Bookwalter® Adaptable Ring System includes the Horizontal Bar and dual ball joint hinge system as well as the Small Round, Medium Round and Medium Oval Ring Segments
504811	Small Round Ring Segments
504812	Medium Round Ring Segments
504813	Medium Oval Ring Segments



504810

### Bookwalter® Adaptable Ring System Bridge

CODE	DESCRIPTION
504687	For use with 50-4810



### Bookwalter® Elliptical Ring

For Obese Patients

CODE	DESCRIPTION	LENGTH
50-4595	Segmented	14 ½ in x 15 in 368 w x 381 mm



## Retractors (Bookwalter® Rings)

### Bookwalter® Oval Ring

CODE	DESCRIPTION	LENGTH	
50-4558	Small	8 x 12 ¼ in	203 x 311 mm
50-4557	Medium	10 ½ in x 14 ½ in	267 x 368 mm
50-4556	Large	12 x 18 ½ in	305 x 470 mm



50-4556

### Bookwalter® Round Ring

CODE	DESCRIPTION	LENGTH (INNER DIMENSION)	
50-4584	Small	8 ½ in	216 mm
50-4559	Medium	10 ½ in	267 mm
50-4560	Large	12 ½ in	318 mm



50-4584

### Bookwalter® Segmented Round Ring

CODE	DESCRIPTION	DIAMETER	
50-4635	Small, 1 Pair	8 ½ in	216 mm
50-4634	Medium, 1 Pair	10 ½ in	267 mm
50-4633	Large, with Suture Slots	16 in	406 mm



50-4635

## Retractors (Bookwalter® Rings)

### Bookwalter® Round Suture Ring

CODE	DESCRIPTION	LENGTH
50-4684	Large	12½ in 318 mm



### Bookwalter® Segmented Retractor Ring

CODE	DESCRIPTION	DIMENSIONS
50-4587	Small, Consists of One 8½ in (216 mm) Round Ring and Two 4 in Straight Segments	8½ x 14 in 216 x 356 mm
50-4583	Medium, Consists of One 10½ in (267 mm) Round Ring and Two 8 in Straight Segments	10½ x 19½ in 266 x 495 mm
50-4588	Large, Consists of One 12½ in (318 mm) Round Ring and Two 6 in Straight Segments	12½ x 19½ in 317 x 495 mm



50-4588

### Bookwalter® Straight Ring Segments

Sold in Pairs

CODE	DESCRIPTION	LENGTH
50-4636	Straight Ring Segment	4 in 102 mm
50-4637	Straight Ring Segment	6 in 152 mm
50-4638	Straight Ring Segment	8 in 203 mm



50-4638

## Retractor (Bookwalter® Table Posts)

### Bookwalter® Post Holder

CODE	DESCRIPTION	LENGTH
50-4680	For Use with the Violi Gooseneck 50-4681	4 in 102 mm



### Bookwalter® Table Post

CODE	DESCRIPTION	LENGTH
50-4581	Table Post	12 in 305 mm



### Bookwalter® Table Post

CODE	DESCRIPTION	LENGTH
50-4683	Table Post	8 in 203 mm



## Retractors (Bookwalter® Table Posts)

### Bookwalter® Table Post

CODE	DESCRIPTION	LENGTH
BW0144005	Table Post	18 in 458 mm
BW0144003	Table Post	24 in 610 mm



BW0144005

### Bookwalter® Lightweight Table Post

CODE	DESCRIPTION	LENGTH
504688	Lightweight Table Post	12 in 305 mm
504697	Lightweight Table Post	16 in 406 mm



504688

## Abdominal (Vision)

### Ultra™ Swivel Blade

CODE	LENGTH	DIAMETER
59-8816A	12 in	1 in 25 mm



### Ultra™ Blade Loading Locking Retractor Handle

CODE	LENGTH
59-0105	8 in 203 mm



## Retractors (Universal Ring Retractor)

### Universal Ring Big Boy Retractor Blade

CODE	DESCRIPTION	LENGTH	
58-0021	Fenestrated Blade	18 in	458 mm
58-0020	Fenestrated Blade	24 in	610 mm



### Universal Ring Harrington Retractor Blade

CODE	DESCRIPTION	LENGTH	
58-0035	Solid	$\frac{2}{3}$ x 2 $\frac{1}{4}$ in	17 mm x 57 mm
58-0037	Solid	3 x 10 $\frac{1}{2}$ in	76 x 267 mm



## Retractors (Universal Ring Retractor)

### Universal Ring Kelly Retractor Blade

CODE	DESCRIPTION	LENGTH	
58-0025	Stainless, Matte Finish	1 x 3 in	25 x 76 mm
58-0009	Stainless, Matte Finish	2½ x 5 x 3½ in	64 x 127 x 89 mm
58-0017T	Titanium	2½ x 8 x 3½ in	64 x 203 x 89 mm
58-0016T	Titanium	3 x 10½ in	76 x 267 mm



58-0009

### Universal Ring Meyering Retractor Blade

Titanium

CODE	LENGTH	
58-0048T	2 x 4 in	51 x 102 mm
58-0051T	2½ x 3 in	64 x 76 mm



58-0048T

### Universal Ring Pediatric Harrington Retractor Blade

CODE	LENGTH
58-0036	2 x 8 in 50 x 203 mm





## Retractors (Bookwalter®)

### Universal Ring Retractor Blade

Titanium

CODE	DESCRIPTION	DIMENSIONS	
58-0073	Fence, Rigid	2 x 3 <sup>3</sup> / <sub>4</sub> in	51 x 95 mm
58-0044T	Titanium	3 <sup>1</sup> / <sub>2</sub> x 3 <sup>3</sup> / <sub>4</sub> in	89 x 95 mm



58-0073

### Universal Ring Yu-Holtgrew Retractor Blade

CODE	DESCRIPTION	LENGTH
58-0022	Fence, Rigid	4 x 5 in 102 x 127 mm

### Universal Ring Retractor Blade

CODE	DESCRIPTION	LENGTH	
58-0042	Malleable, With Lip	3/4 x 4 in	19 x 102 mm
58-0045	Malleable, With Lip	1/2 x 4 in	13 x 102 mm
58-0049	Malleable, With Lip	1 x 5 in	25 x 127 mm
58-0054	Malleable, With Lip	2 x 8 in	51 x 203 mm
58-0056	Malleable, With Lip	3 x 8 in	76 x 203 mm
58-0057N	Malleable, With Lip	6 x 9 in	152 x 229 mm
58-0044N	Malleable, With Lip	6 x 12 in	152 x 305 mm



58-0057N

## Retractors (Vision)

### Ultra™ Mayo Swivel Blade

CODE	DESCRIPTION	LENGTH
59-8807A	Malleable, Lip	2 x 6 in 51 x 152 mm



### Ultra™ Side Loading Longitudinal Retractor

CODE	DESCRIPTION	LENGTH
59-0101	Segmented	14 x 15 in 356 x 381 mm



### Ultra™ Side Loading Transverse Retractor

CODE	LENGTH
59-0100	2 3/4 x 2 in 70 x 51 mm



## Retractors (Vision)



### Vision Retractor System

CODE	DESCRIPTION	DIMENSIONS		QTY
59-8850	System, Includes The Following Items:			
59-8802	Table Clamp with Vertical Post			1
59-8803	Retractor Clamp			6
59-8805	Vision Frame			1
59-8807	Mayo Swivel	2 3/4 x 2 in	70 x 51 mm	2
59-8809	Deaver Swivel	2 3/4 x 4 1/2 in	70 x 114 mm	1
59-8811	Harrington "Sweetheart"	2 x 5 in	51 x 127 mm	1
59-8813	Kelly Swivel "Modified"	3 x 2 1/2 in	76 x 64 mm	1
59-8814	Kelly Swivel "Modified"	3 x 4 in	76 x 102 mm	1
59-8815	Malleable Swivel, Perforated	3 x 6 in	76 x 152 mm	1
59-8816	Malleable Swivel, Perforated	3 x 6 1/2 in	76 x 165 mm	1
59-8818	Fence Swivel, Perforated	4 x 6 in	102 x 152 mm	1
59-8821	Splanchnic Swivel	2 x 6 in	51 x 152 mm	1
59-8828	Sterilization Case			1

Note: Individual components are available, in single quantities, by referencing their unique product code upon ordering.

## Retractors (Vision)

### Vision Retractor System

CODE	DESCRIPTION	DIMENSIONS		QTY
59-8855	System Includes The Following Items:			
59-8802	Table Clamp with Vertical Post			1
59-8803	Retractor Clamp			8
59-8804	Extension Arm, Hinged			1
59-8805	Vision Frame			1
59-8807	Mayo Swivel	2 <sup>3</sup> / <sub>4</sub> x 2 in	70 x 51 mm	2
59-8809	Deaver Swivel	2 <sup>3</sup> / <sub>4</sub> x 4 <sup>1</sup> / <sub>2</sub> in	70 x 114 mm	1
59-8811	Harrington "Sweetheart"	2 x 5 in	51 x 127 mm	1
59-8813	Kelly Swivel "Modified"	3 x 2 <sup>1</sup> / <sub>2</sub> in	76 x 64 mm	1
59-8814	Kelly Swivel "Modified"	3 x 4 in	76 x 102 mm	1
59-8815	Malleable Swivel, Perforated	3 x 6 in	76 x 152 mm	1
59-8816	Malleable Swivel, Perforated	3 x 6 <sup>1</sup> / <sub>2</sub> in	76 x 165 mm	1
59-8818	Fence Swivel, Perforated	4 x 6 in	102 x 152 mm	1
59-8821	Splanchnic Swivel	2 x 6 in	51 x 152 mm	1
59-8828	Sterilization Case			1

Note: Individual components are available, in single quantities, by referencing their unique product code upon ordering.

## Retractors (Laparoscopic)



24-1800

### Fan Retractor

CODE	DESCRIPTION	LENGTH	
24-1800	Pressure Lock Handle, 60° Opening 10 mm 60 mm	9 <sup>1</sup> / <sub>2</sub> in	241 mm
32-1800	Pressure Lock Handle, 60° Opening 10 mm 60 mm	12 <sup>3</sup> / <sub>5</sub>	320 mm
38-1800	Pressure Lock Handle, 60° Opening 10 mm 60 mm	15 in	381 mm
45-1800	Pressure Lock Handle, 60° Opening 10 mm 60 mm	17 <sup>3</sup> / <sub>4</sub>	450 mm

## Retractors (Laparoscopic)

### Fan Retractor

Pressure Lock Handle

CODE	DESCRIPTION	LENGTH
24-1800R	60° Opening 10 mm 60 mm	9½ in 240 mm
32-1800R	60° Opening 10 mm 60 mm	12¾ 320 mm
38-1800R	60° Opening 10 mm 60 mm	15 in 380 mm
45-1800R	60° Opening 10 mm 60 mm	17¾ 450 mm

### Fan Retractor

CODE	DESCRIPTION	LENGTH
90-9800	Curve 5.0 mm	6¼ in 155 mm



### Liver Fan Retractor

Pressure Lock Handle

CODE	DESCRIPTION
68-1590	5.0 mm
68-1591	10 mm
68-1593	5.0 mm Adjustable
68-1594	10 mm Adjustable



### Bookwalter® Telescopic Laparoscopic Holder

CODE	DESCRIPTION	LENGTH
504685	Telescopic with Instrument holder for instruments, trocars and laparoscopic retractors 5.0 mm - 17 mm.	



## Retractors (Laparoscopic)



### Bookwalter® Universal Flex Arm System

CODE	DESCRIPTION
50-4805	Includes Part Numbers Below:
50-4806	Ring Adapter for Bookwalter® Flex Arm
50-4807	Lap Instrument Adapter (Spring) for Bookwalter® Flex Arm
50-4808	Camera Lens Adapter for Bookwalter® Flex Arm
50-4809	Camera Housing Adapter for Bookwalter® Flex Arm

## Retractors (Laparoscopic)



50-4507

### Bookwalter® Table Fix & Ring Case, 12 In (305 mm) Post

CODE	DESCRIPTION
50-4507	Designed to Hold the Following Bookwalter® Components:
50-4581	Table Post
50-4582	Horizontal Flex Bar
50-4552	Retractor Horizontal Bar
50-4583	Medium Segmented Ring
50-4557	Retractor, Oval Ring Medium

For other specialty instrument holders and container systems please speak to your Symmetry Surgical Representative.

## Retractors (Cerebellar)

### Adson Cerebellar Retractor

4 x 4 Prongs

CODE	DESCRIPTION	LENGTH
24-2801	Sharp	7½ in 191 mm
24-2802	Straight Arms, Sharp	7½ in 191 mm

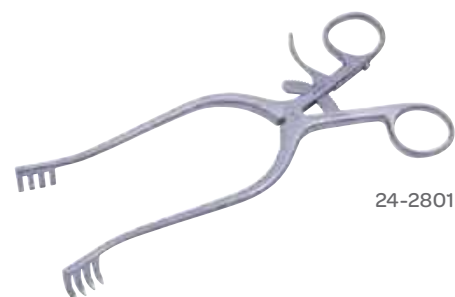

24-2801

### Miskimon Cerebellar Retractor

7 x 7 Prongs, Sharp, Angled Arms

CODE	BLADE DEPTH	LENGTH
24-2810	1¼ in 32 mm	8¾ in 222 mm



## Retractors (Epicardial)

### Meyerding Finger Retractor

CODE	DESCRIPTION	LENGTH
20-1004	#4, Single Ring	7⅞ in 181 mm
20-1005	#5, Single Ring	7⅞ in 181 mm
20-1006	#6, Single Ring	7⅞ in 181 mm



20-1004



## Retractors (Gall Bladder)

### Foss Gall Bladder Retractor

CODE	DESCRIPTION	WIDTH		LENGTH	
23-6300	Bladder Retractor	1¾ in	44 mm	10 in	254 mm



### Murphy Gall Bladder Retractor

CODE	DESCRIPTION	WIDTH		LENGTH	
23-6292	Bladder Retractor	2 in	51 mm	11 in	279 mm



### Allison's Lung Retractor

CODE	DESCRIPTION	LENGTH
50-8152	Adult, Small	10½ in 267 mm
50-8153	Adult, Large	12½ in 318 mm



50-8153

## Retractors (Hand-Held)

### Meyering Finger Retractor

Single Ring

CODE	DESCRIPTION	LENGTH	CODE	DESCRIPTION	LENGTH
20-1001	#1	7 1/8 in 181 mm	20-1004	#4	7 1/8 in 181 mm
20-1002	#2	7 1/8 in 181 mm	20-1005	#5	7 1/8 in 181 mm
20-1003	#3	7 1/8 in 181 mm	20-1006	#6	7 1/8 in 181 mm



20-1001

### Volkman Finger Retractor

CODE	DESCRIPTION	LENGTH	CODE	DESCRIPTION	LENGTH
22-2602	2 Prong, Sharp	4 1/2 in 114 mm	27-2702	2 Prong, Blunt	4 1/2 in 114 mm
22-2603	3 Prong, Sharp	4 1/2 in 114 mm	22-2703	3 Prong, Blunt	4 1/2 in 114 mm
22-2604	4 Prong, Sharp	4 1/2 in 114 mm	22-2704	4 Prong, Blunt	4 1/2 in 114 mm
22-2606	6 Prong, Sharp	4 1/2 in 114 mm	22-2706	6 Prong, Blunt	4 1/2 in 114 mm

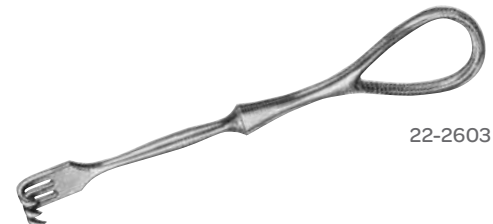

22-2603

### Flexible Neck Retractor

CODE	DESCRIPTION	LENGTH	CODE	DESCRIPTION	LENGTH
20-6452	2 Prong, Sharp	6 1/4 in 159 mm	20-6552	2 Prong, Blunt	6 1/4 in 159 mm
20-6453	3 Prong, Sharp	6 1/4 in 159 mm	20-6553	3 Prong, Blunt	6 1/4 in 159 mm

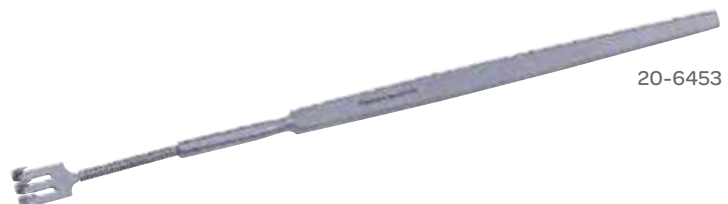

20-6453

## Retractors (Hand-Held)

### Baby Deaver Retractor

CODE	DESCRIPTION	BLADE (W X D)		LENGTH	
50-5630	Standard Handle	$\frac{5}{8}$ x 2 $\frac{1}{2}$ in	16 x 64 mm	8 in	203 mm
50-5631	Standard Handle	1 x 2 $\frac{1}{2}$ in	25 x 64 mm	8 in	203 mm

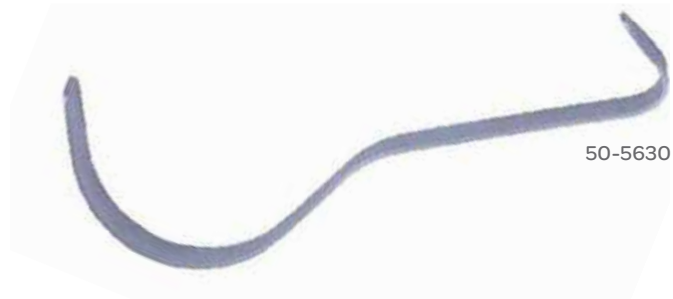

### Blade Retractor

CODE	WIDTH	LENGTH	HANDLE LENGTH		CODE	WIDTH	LENGTH	HANDLE LENGTH	
50-1050	18 mm	3 in 76 mm	4 $\frac{1}{2}$ in	114 mm	50-1053	23 mm	3 in 76 mm	4 $\frac{1}{2}$ in	114 mm
50-1052	20 mm	3 in 76 mm	4 $\frac{1}{2}$ in	114 mm					



### Boley Retractor

CODE	DESCRIPTION	BLADES (W X D)		LENGTH	
50-5608	#1, Double-Ended	$\frac{1}{2}$ x $\frac{1}{2}$ in	13 x 13 mm	6 $\frac{1}{4}$ in	159 mm
		$\frac{7}{16}$ x $\frac{7}{16}$ in	11 x 11 mm		



## Retractors (Hand-Held)

### Campbell Nerve Root Retractor

CODE	DESCRIPTION	BLADE WIDTH	LENGTH
50-1326	Malleable Shaft	$\frac{3}{8}$ in 10 mm	8½ in 216 mm



### Children's Hospital Retractor

CODE	DESCRIPTION	BLADE (W X D)	LENGTH
50-4100	Small, Double-Ended	$\frac{7}{16} \times \frac{7}{8}$ in 11 x 22 mm $\frac{9}{16} \times 1\frac{3}{8}$ in 14 x 35 mm	5½ in 140 mm



### Children's Hospital Retractor

CODE	DESCRIPTION	BLADE (W X D)	LENGTH
50-5645	S-Shaped, Double-Ended	$\frac{1}{4} \times \frac{3}{4}$ in 6.0 x 19 mm $\frac{1}{2} \times \frac{3}{4}$ in 13 x 19 mm	4⅞ in 124 mm



## Retractors (Hand-Held)

### Collins Retractor

CODE	DESCRIPTION	LENGTH	QTY
22-1215	Double-Ended	6½ in 165 mm	Set of 2



### Crile Retractor

CODE	DESCRIPTION	BLADE (W X D)	LENGTH
50-4105	Double-Ended	¼ x ¾ in	6.0 x 19 mm
		⅜ x ⅝ in	5.0 x 16 mm



### Cushing Decompression Retractor

CODE	DESCRIPTION	SIZE (W X D)	LENGTH
50-1060	Fenestrated Blade	½ in x ⅞ in 13 x 22 mm	8⅜ in 213 mm



### Cushing Retractor

CODE	JAW LENGTH	LENGTH	CODE	JAW LENGTH	LENGTH
32-3633	1.0 cm	11 in 279 mm	32-3634	1.1 cm	14 in 356 mm



32-3633

## Retractors (Hand-Held)

### Cushing Vein Retractor

CODE	DESCRIPTION	BLADE (W X D)	LENGTH
50-1020	Vein Retractor	13 x 10 mm	9 in 229 mm
50-1022	Vein Retractor	9 x 6 mm	7 <sup>3</sup> / <sub>4</sub> in 197 mm
20-1750	Fenestrated Handle	11 mm	9 in 229 mm
20-1752	Fenestrated Handle	11 mm	14 in 356 mm



### Davidson Scapular Retractor

CODE	DESCRIPTION	BLADE (W X D)	LENGTH
50-8096	Scapular Retractor	3 <sup>1</sup> / <sub>2</sub> x 3 in 89 x 76 mm	6 in 152 mm

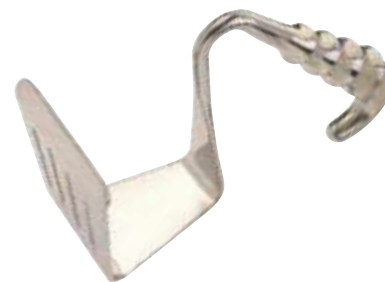

### Davis Retractor

CODE	DESCRIPTION	BLADES (W X D)	LENGTH
20-0510	Retractor	6.0 x 17 mm, 9.0 x 20 mm	6 in 152 mm



## Retractors (Hand-Held)

### Deaver Baby Retractor

CODE	DESCRIPTION	WIDTH		LENGTH	
23-7500	Standard Handle	$\frac{3}{8}$ in	10 mm	7 in	176 mm
23-7217	Standard Handle	$\frac{1}{16}$ in	17 mm	8 in	203 mm
23-7225	Standard Handle	1 in	25 mm	8 in	203 mm



23-7217

### Deaver Retractor

CODE	DESCRIPTION	WIDTH		LENGTH	
23-7211	Ring-Grip Handle	1 in	25 mm	12 in	305 mm
23-7212	Ring-Grip Handle	1 in	25 mm	12 in	305 mm
23-7213	Ring-Grip Handle	$1\frac{1}{2}$ in	38 mm	12 in	305 mm
23-7214	Ring-Grip Handle	2 in	51 mm	12 in	305 mm
23-7215	Ring-Grip Handle	3 in	76 mm	12 in	305 mm
23-7216	Ring-Grip Handle	4 in	102 mm	12 in	305 mm
23-7218	Ring-Grip Handle	2 in	51 mm	15 in	305 mm
23-7221	Ring-Grip Handle	1 in	25 mm	16 in	405 mm



23-7211

### Deaver Retractor

Standard Handle

CODE	WIDTH	LENGTH	CODE	WIDTH	LENGTH
23-7501	$\frac{3}{4}$ in 19 mm	7 in 178 mm	23-7504	1 in 25 mm	12 in 305 mm
23-7502	$\frac{7}{8}$ in 22 mm	$8\frac{1}{2}$ in 216 mm	23-7505	1 in 25 mm	12 in 305 mm
23-7503	1 in 25 mm	$9\frac{1}{4}$ in 235 mm	23-7507	$1\frac{1}{2}$ in 38 mm	12 in 305 mm
23-7244	1 in 25 mm	10 in 254 mm	23-7508	2 in 51 mm	12 in 305 mm
			23-7218	2 in 51 mm	15 in 381 mm



23-7244

## Retractors (Hand-Held)

### Deaver Retractor

Standard Handle

CODE	DESCRIPTION	WIDTH		LENGTH	
50-4303	#1	1 in	25 mm	12 in	305 mm
50-4304	#2	1 in	25 mm	12 in	305 mm
50-4306	#3	1½ in	38 mm	12 in	305 mm
50-4307	#4	2 in	51 mm	12 in	305 mm
50-4308	#5	3 in	76 mm	12 in	305 mm



50-4307

### Deaver Retractor

CODE	DESCRIPTION	WIDTH		LENGTH	
50-4316	#1, Ring-Grip Handle	1 in	25 mm	12 in	305 mm
50-4320	#4, Ring-Grip Handle	2 in	51 mm	12 in	305 mm



50-4316

### Bariatric Deaver Retractor

CODE	DESCRIPTION	BLADE LENGTH		HANDLE LENGTH	
32-3635	Deaver Retractor	2½ in	64 mm	14½ in	368 mm

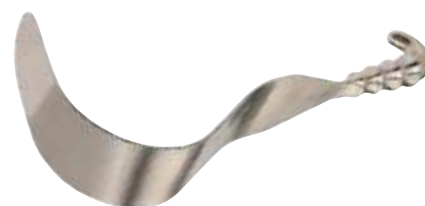

### D'Errico Nerve Root Retractor

CODE	DESCRIPTION	BLADE WIDTH		LENGTH	
50-1270	Nerve Root Retractor	¼ in	6.0 mm	9 in	229 mm





## Retractors (Hand-Held)

### Dural Suction Retractor

CODE	ANGLE	HANDLE LENGTH		TIP DEPTH		TIP WIDTH		WORKING DISTANCE	
46-3012	90°	4 <sup>5</sup> / <sub>8</sub> in	117 mm	<sup>1</sup> / <sub>4</sub> in	6.0 mm	<sup>9</sup> / <sub>32</sub> in	8.0 mm	4 <sup>3</sup> / <sub>4</sub> in	121 mm



### Farabeuf Baby Retractor

CODE	DESCRIPTION	LENGTH		QTY
22-1015	Double-Ended	6 in	152 mm	Set of 2



### Flexible Nerve Root Retractor

CODE	DESCRIPTION	BLADE LENGTH		BLADE WIDTH		LENGTH	
50-1209	Nerve Root Retractor	1 in	25 mm	<sup>5</sup> / <sub>16</sub> in	8.0 mm	8 <sup>1</sup> / <sub>2</sub> in	216 mm



## Retractors (Hand-Held)

### Goelet Retractor

CODE	DESCRIPTION	BLADE (W X D)		LENGTH
23-3752	Double-Ended	1¼ x 1 in	32 x 25 mm	7½ in 191 mm
		1⅝ x 1¼ in	41 x 32 mm	
50-4095	Double-Ended	1¼ x 1 in	32 x 25 mm	7½ in 191 mm
		1⅝ x 1¼ in	41 x 32 mm	



50-4095

### Green Retractor

CODE	DESCRIPTION	LENGTH
23-3512	Fenestrated Blade	8½ in 216 mm



### Greene Thyroid Retractor

CODE	DESCRIPTION	BLADE (W X D)		LENGTH
50-4297	Fenestrated Blade	1⅛ x 1 in	17 x 25 mm	8¾ in 222 mm



### Harrington-Pemberton Retractor

CODE	DESCRIPTION	SIZE		LENGTH
23-7040	Retractor	1⅝ x 5 in	41 x 127 mm	12½ in 318 mm
23-7106	Retractor	2½ x 7⅛ in	64 x 181 mm	12½ in 318 mm



23-7040

## Retractors (Hand-Held)

### Harrington Splanchnic Retractor

CODE	DESCRIPTION	BLADE WIDTH		LENGTH	
50-8102	Splanchnic Retractor	2½ in	64 mm	12½ in	318 mm



### Hayes Hand Retractor

CODE	DESCRIPTION	BLADE WIDTH		LENGTH	
20-1776	Hand Retractor	3.0 mm		6¼ in	159 mm
20-1777	Hand Retractor	6.0 mm		6¼ in	159 mm



20-1776

### Heiss Retractor

4 x 4 Prongs, Cross-Action

CODE	DESCRIPTION	LENGTH		CODE	DESCRIPTION	LENGTH	
24-0909	Sharp	4 in	102 mm	24-0910	Blunt	4 in	102 mm
24-0911	Sharp	4 in	102 mm	24-0912	Blunt	4 in	102 mm



24-0909

### Hibbs Retractor

CODE	DESCRIPTION	BLADE DEPTH		SIZE (W X D)		LENGTH	
23-6381	Sharp Teeth	1 in	25 mm	1 x 3 in	25 x 76 mm	9½ in	241 mm
23-6382	Sharp Teeth	1 in	25 mm	1 x 3¾ in	25 x 95 mm	9½ in	241 mm
50-2558C	Double-Ended, Set Two	2 in	51 mm	1 x ¾ in	25 x 19 mm	9½ in	241 mm



23-6381

## Retractors (Hand-Held)

### Hohmann Retractor

CODE	DESCRIPTION	WIDTH	LENGTH
77-1118	Retractor	18 mm	9½ in 241 mm



### Israel Retractor

CODE	DESCRIPTION	PRONGS	BLADES (W X D)	LENGTH
50-4246	Blunt	4 Prong	1¾ x 1¾ in 44 x 44 mm	7¾ in 197 mm
22-7204	Blunt	4 Prong	1½ x 1½ in 38 x 38 mm	10 in 254 mm
22-7205	Blunt	5 Prong	2 x 1¾ in 51 x 44 mm	10 in 254 mm
22-7206	Blunt	6 Prong	2¾ x 2 in 60 x 51 mm	10 in 254 mm



### Kasdan Hand Retractor

CODE	DESCRIPTION	BLADE WIDTH	LENGTH
20-0540	Double-Ended		6¼ in 159 mm



## Retractors (Hand-Held)

### Kelly Retractor

CODE	DESCRIPTION	BLADE (W X L)		LENGTH	
23-4701	Standard Handle	1½ x 2 in	35 x 51 mm	10¼ in	260 mm
23-4702	Standard Handle	2 x 2½ in	51 x 64 mm	10¼ in	260 mm
23-4703	Standard Handle	2½ x 3 in	64 x 76 mm	10¼ in	260 mm
23-4711	Lamb Handle	1¼ x 2 in	32 x 51 mm	10¼ in	260 mm
23-4712	Lamb Handle	2 x 2½ in	51 x 64 mm	10¼ in	260 mm
23-4713	Lamb Handle	2½ x 3 in	64 x 76 mm	10¼ in	260 mm
23-4714	Lamb Handle	3 x 3½ in	76 x 89 mm	10¼ in	260 mm
23-4715	Ring-Grip Handle	1½ x 2 in	38 x 51 mm	10¼ in	260 mm
23-4716	Ring-Grip Handle	2 x 2½ in	51 x 64 mm	10¼ in	260 mm
23-4717	Ring-Grip Handle	2½ x 3 in	63 x 76 mm	10¼ in	260 mm
23-4718	Ring-Grip Handle	3 x 3½ in	76 x 89 mm	10¼ in	260 mm



23-4701

### Kelly Retractor

Standard Handle

CODE	DESCRIPTION	BLADE (W X D)		LENGTH	
50-4110	Small	1½ x 2 in	38 x 51 mm	9¼ in	235 mm
50-4111	Medium	2 x 2½ in	51 x 64 mm	9½ in	241 mm
50-4112	Large	2½ x 3 in	64 x 76 mm	10 in	254 mm



50-4110

### Kelly Retractor

Ring-Grip Handle

CODE	DESCRIPTION	BLADE (W X D)		LENGTH	
50-4115	Small	1½ x 2 in	38 x 51 mm	9¼ in	235 mm
50-4116	Medium	2 x 2½ in	51 x 64 mm	9¼ in	235 mm
50-4117	Large	2½ x 3 in	64 x 76 mm	10 in	254 mm
50-4118	XL	3 x 3½ in	76 x 89 mm	10 in	254 mm



50-4117

## Retractors (Hand-Held)

### Knapp Retractor

CODE	DESCRIPTION	PRONGS	WIDTH	LENGTH
20-5516	Sharp	4 Prong	6.0 mm	5 in 127 mm
20-5517	Blunt	4 Prong	6.0 mm	5 in 127 mm



### Lahey Retractor

CODE	DESCRIPTION	BLADE (W X D)	LENGTH
23-0306	Retractor		7 <sup>3</sup> / <sub>4</sub> in 197 mm
50-4040C	Thyroid Retractor	1/4 x 1 in 6.0 x 25 mm	8 <sup>1</sup> / <sub>8</sub> in 206 mm

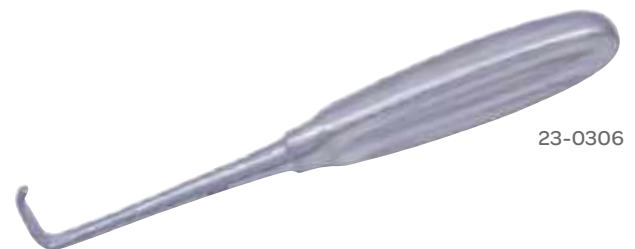

23-0306

### Langenbeck Retractor

CODE	DESCRIPTION	BLADE (W X D)	LENGTH
23-0710	Hollow Handle	3/8 x 1 1/2 in 10 x 38 mm	8 3/4 in 222 mm
50-4255	#1	3/8 x 1 5/8 in 10 x 41 mm	8 1/4 in 210 mm
50-4256	#2	1/2 x 1 5/8 in 13 x 41 mm	8 1/4 in 210 mm



50-4255

## Retractors (Hand-Held)

### Love Nerve Root Retractor

CODE	DESCRIPTION	BLADE WIDTH	SHAFT LENGTH	LENGTH
50-1315	Straight	¼ in 6.0 mm	4 in 102 mm	7 ⅝ in 194 mm
50-1316	90° Angle	¼ in 6.0 mm	4 in 102 mm	3 ¾ in 95 mm
50-1317	135° Angle	¼ in 6.0 mm	4 in 102 mm	3 ¼ in 83 mm



### Mathieu Retractor

CODE	DESCRIPTION	PRONG WIDTH	BLADE WIDTH	BLADE DEPTH	LENGTH
50-4290	Double-Ended, 3 Prong, Sharp	⅜ in 10 mm	¼ in 6.0 mm	3/4 in 19 mm	6 ½ in 165 mm



### Mayo Abdominal Retractor

CODE	DESCRIPTION	LENGTH
23-6346	2 ¾ in 70 mm	10 in 254 mm

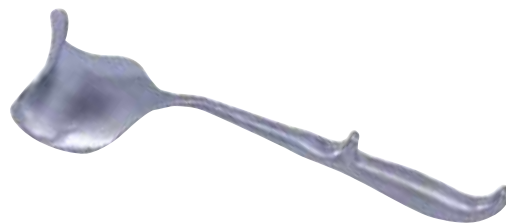

### McBurney Thyroid Retractor

CODE	DESCRIPTION	BLADE (W X D)	LENGTH
50-4410	Fenestrated Blades	⅜ x ¾ in 10 x 19 mm	7 ⅝ in 187 mm



## Retractors (Hand-Held)

### Meyerding Retractor

CODE	DESCRIPTION	BLADE (W X D)		LENGTH	
23-6301	#1 Small	$\frac{5}{8}$ x 2 in	16 x 51 mm	9 in	229 mm
23-6302	#2 Medium	1 x 3 in	25 x 76 mm	9½ in	241 mm
23-6303	#3 Large	2 x 3½ in	51 x 89 mm	9½ in	241 mm



23-6301

### Meyerding Laminectomy Retractor

CODE	DESCRIPTION	BLADE (W X D)		LENGTH	
50-1065	Small, Self-Retaining	$\frac{5}{8}$ x 2 in	16 x 51 mm	9 in	229 mm
50-1066	Medium, Self-Retaining	1 x 3 in	25 x 76 mm	9½ in	241 mm
50-1067	Large, Self-Retaining	2 x 3½ in	51 x 89 mm	9½ in	241 mm



50-1065

### Murphy Retractor

CODE	DESCRIPTION	LENGTH
22-5004	4 Prong, Sharp	7¾ in 197 mm
50-8072	4 Prong, Sharp	7¾ in 197 mm
22-5006	6 Prong, Sharp	7¾ in 197 mm
22-5103	3 Prong, Blunt	7¾ in 197 mm
22-5104	4 Prong, Blunt	7¾ in 197 mm
22-5106	6 Prong, Blunt	7¾ in 197 mm



50-8072

### Ollier Retractor

CODE	DESCRIPTION	LENGTH
22-7002	4 Prong, Blunt	8½ in 216 mm
50-4253	4 Prong, Blunt	9 in 229 mm



50-4253



## Retractors (Hand-Held)

### Parker Mott Retractor

CODE	DESCRIPTION	LENGTH	QTY
22-1516	Double-Ended	6½ in 166 mm	Set of 2



### Parker Retractor

Double-Ended

CODE	DESCRIPTION	LENGTH	QTY
22-1413	Small	5 in 127 mm	Set of 2
50-4090	Small	5½ in 140 mm	Set of 2
22-1418	Large	7 in 176 mm	Set of 2



22-1418

### Plastic Hand Retractor

CODE	DESCRIPTION	WIDTH	LENGTH
20-6102	2 Prong, Blunt	⅜ in 5.0 mm	6¾ in 171 mm
20-6103	3 Prong, Blunt	⅓ in 8.0 mm	6¾ in 171 mm
20-6104	4 Prong, Blunt	⅞ in 11 mm	6¾ in 171 mm



20-6103

### Plastic Hand Surgery Retractor

CODE	DESCRIPTION	DESCRIPTION	LENGTH
20-6001	9.0 mm Wide	1 Prong, Sharp	6¾ in 171 mm
20-6002	5.0 mm Wide	1 Prong, Sharp	6¾ in 171 mm
20-6003	8.0 mm Wide	3 Prong, Sharp	6¾ in 171 mm
20-6004	11 mm Wide	4 Prong, Sharp	6¾ in 171 mm



20-6002

## Retractors (Hand-Held)

### Ragnell Retractor

CODE	DESCRIPTION	BLADE (W X D)	LENGTH
50-2608	Double-Ended	$\frac{1}{8} \times \frac{1}{4}$ in 3.0 x 6.0 mm $\frac{1}{4} \times \frac{5}{8}$ in 6.0 x 16 mm	6 in 152 mm
20-0525	Double-Ended	$\frac{1}{8} \times \frac{1}{4}$ in 3.0 x 6.0 mm	6 in 152 mm
20-0526	Double-Ended	$\frac{1}{8} \times \frac{3}{16}$ in 3.0 x 5.0 mm	6 in 152 mm



50-2608

### Ribbon Malleable Retractor

CODE	DESCRIPTION	BLADE WIDTH	LENGTH
50-5637	Malleable, Double-Ended	$\frac{1}{2}$ in 13 mm	8 in 203 mm
50-5639	Malleable, Double-Ended	$\frac{3}{4}$ in 19 mm	8 in 203 mm
50-4210	Malleable, Double-Ended	1 in 25 mm	13 in 330 mm
50-4212	Malleable, Double-Ended	$1\frac{1}{2}$ in 38 mm	13 in 330 mm
50-4214	Malleable, Double-Ended	2 in 51 mm	13 in 330 mm



50-4212

### Ribbon Retractor

Double-Ended, Malleable

CODE	WIDTH	LENGTH	CODE	WIDTH	LENGTH
22-0006	$\frac{1}{4}$ in 6.0 mm	8 in 203 mm	22-0253	$1\frac{1}{4}$ in 32 mm	13 in 330 mm
22-0012	$\frac{1}{2}$ in 13 mm	8 in 203 mm	22-0254	$1\frac{1}{2}$ in 38 mm	13 in 330 mm
22-0017	$\frac{5}{8}$ in 16 mm	8 in 203 mm	22-0255	2 in 51 mm	13 in 330 mm
22-0025	1 in 25 mm	8 in 203 mm	22-0256	$2\frac{1}{2}$ in 64 mm	13 in 330 mm
22-0027	1 in 25 mm	10 in 254 mm	22-0257	3 in 76 mm	13 in 330 mm
22-0035	$1\frac{3}{4}$ in 44 mm	10 in 254 mm	22-0258	4 in 102 mm	13 in 330 mm
22-0251	$\frac{3}{4}$ in 19 mm	13 in 330 mm	22-0259	5 in 127 mm	13 in 330 mm
22-0252	1 in 25 mm	13 in 330 mm			



22-0006

## Retractors (Hand-Held)

### Richardson Appendectomy Retractor

CODE	DESCRIPTION	BLADE (W X D)	LENGTH
50-4130C	Standard Handle	$1\frac{3}{16}$ x 2 in 21 x 55 mm	9 $\frac{1}{4}$ in 235 mm
50-4131	Ring-Grip Handle	$\frac{3}{4}$ x 2 in 19 x 51 mm	9 $\frac{1}{4}$ in 235 mm



50-4130C

### Richardson Retractor

CODE	DESCRIPTION	BLADE (W X D)	LENGTH
23-4501	Standard Handle	$\frac{3}{4}$ x 1 in 19 x 25 mm	9 $\frac{1}{2}$ in 241 mm
23-4502	Standard Handle	1 x 1 $\frac{1}{4}$ in 25 x 32 mm	9 $\frac{1}{2}$ in 241 mm
23-4503	Standard Handle	1 $\frac{1}{2}$ x 1 $\frac{1}{2}$ in 38 x 38 mm	9 $\frac{1}{2}$ in 241 mm
23-4504	Standard Handle	$\frac{3}{4}$ x 2 in 19 x 51 mm	9 $\frac{1}{2}$ in 241 mm
23-4505	Standard Handle	1 $\frac{5}{8}$ x 2 $\frac{1}{2}$ in 41 x 64 mm	9 $\frac{1}{2}$ in 241 mm



23-4501

### Richardson Retractor

CODE	DESCRIPTION	BLADE (W X D)	LENGTH
23-4511	Lamb Handle	$\frac{3}{4}$ x 1 in 19 x 25 mm	9 $\frac{1}{2}$ in 241 mm
23-4512	Lamb Handle	1 x 1 $\frac{1}{4}$ in 25 x 32 mm	9 $\frac{1}{2}$ in 241 mm
23-4514	Lamb Handle	$\frac{3}{4}$ x 2 in 19 x 51 mm	9 $\frac{1}{2}$ in 241 mm



23-4514

## Retractors (Hand-Held)

### Richardson Retractor

CODE	DESCRIPTION	SIZE	BLADE (W X D)		LENGTH	
23-4515	Ring-Grip Handle	Small	$\frac{3}{4}$ x 1 in	19 x 25 mm	9 $\frac{1}{2}$ in	241 mm
23-4516	Ring-Grip Handle	Medium	1 x 1 $\frac{1}{4}$ in	25 x 32 mm	9 $\frac{1}{2}$ in	241 mm
23-4517	Ring-Grip Handle	Large	1 $\frac{1}{2}$ x 1 $\frac{1}{2}$ in	38 x 38 mm	9 $\frac{1}{2}$ in	241 mm
23-4518	Ring-Grip Handle	Small	$\frac{3}{4}$ in x 2 in	19 x 51 mm	9 $\frac{1}{2}$ in	241 mm
23-4520	Ring-Grip Handle	Medium	1 $\frac{3}{16}$ x 4 in	30 x 100 mm	9 $\frac{1}{2}$ in	241 mm
50-4120	Standard Handle	Small	$\frac{3}{4}$ x 1 in	19 x 25 mm	9 $\frac{1}{4}$ in	235 mm
50-4121	Standard Handle	Medium	1 x 1 $\frac{1}{4}$ in	25 x 32 mm	9 $\frac{1}{4}$ in	235 mm
50-4122	Standard Handle	Large	1 $\frac{1}{2}$ x 1 $\frac{3}{4}$ in	38 x 44 mm	9 $\frac{1}{2}$ in	241 mm
50-4123C	Ring-Grip Handle	Small	$\frac{3}{4}$ x 1 in	19 x 25 mm	9 $\frac{1}{2}$ in	241 mm
50-4124C	Ring-Grip Handle	Medium	1 x 1 $\frac{1}{4}$ in	32 mm	9 $\frac{1}{2}$ in	241 mm
50-4125C	Ring-Grip Handle	Large	1 $\frac{1}{4}$ x 1 $\frac{1}{2}$ in	38 mm	9 $\frac{1}{2}$ in	241 mm



50-4122

### Richardson-Eastman Retractor

#### Double-Ended

CODE	DESCRIPTION	BLADE (W X D)		LENGTH	
23-4550	Set of Two	$\frac{7}{8}$ x $\frac{5}{16}$ in	22 x 8.0 mm	10 in	254 mm
23-4551	Small Only	1 $\frac{1}{2}$ x 1 $\frac{5}{8}$ in	38 x 41 mm	10 in	254 mm
23-4552	Large Only	1 $\frac{3}{16}$ x 1 $\frac{3}{16}$ in	44 x 64 mm	10 $\frac{1}{2}$ in	267 mm
50-4135C	Set of Two (Small and Large)	1 $\frac{3}{4}$ x 2 $\frac{1}{2}$ in	44 x 64 mm	10 in	254 mm

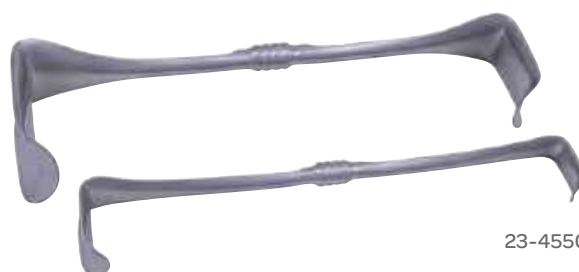

23-4550

## Retractors (Hand-Held)

### Rollet Lachrymal Sac Retractor

CODE	DESCRIPTION	LENGTH
50-6536	Four Prong, Sharp	5¼ in 133 mm



### Roux Retractor

Double-Ended

CODE	BLADE (W X D)		LENGTH	
22-1614	7⁄8 x 1½ in	22 x 29 mm	5½ in	140 mm
22-1615	1 x 1½ in	25 x 38 mm	6 in	152 mm
22-1616	1¼ x 1¾ in	32 x 45 mm	6½ in	166 mm



22-1614

### Sauerbruch Retractor

CODE	DESCRIPTION	BLADE (W X D)		LENGTH	
23-1501	#1	¾ x 1¾ in	19 x 44 mm	9 in	229 mm
23-1502	#2	15⁄16 x 2½ in	24 x 54 mm	9 in	229 mm
23-1503	#3	13⁄16 x 2¾ in	21 x 73 mm	9 in	229 mm



23-1501

### Schoenborn Retractor

CODE	DESCRIPTION	BLADE (W X D)		LENGTH	
20-4460	13 x 6.0 mm	½ x ¼ in	13 x 6.0 mm	8 in	203 mm

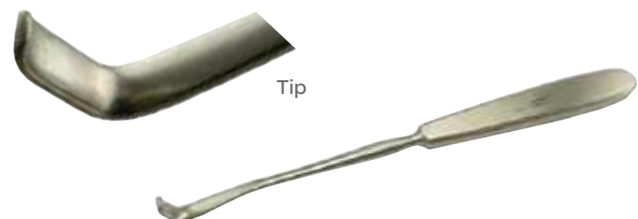

Tip

## Retractors (Hand-Held)

### Seeburger Retractor

CODE	LENGTH
22-0101	5½ in 140 mm



### Senn Retractor

Double-Ended

CODE	DESCRIPTION	PRONG (W)	BLADE (W X D)	LENGTH
20-0508	3 Prong, Sharp	5/16 in 8.0 mm	1/4 x 3/4 in 6.0 x 19 mm	6 1/4 in 159 mm
50-4260	3 Prong, Sharp	5/16 in 8.0 mm	1/4 x 3/4 in 6.0 x 19 mm	6 7/8 in 175 mm
20-0509	3 Prong, Blunt	5/16 in 8.0 mm	1/4 x 3/4 in 6.0 x 19 mm	6 1/4 in 159 mm
50-4261	3 Prong, Blunt	5/16 in 8.0 mm	1/4 x 3/4 in 6.0 x 19 mm	6 7/8 in 175 mm



### Turner-Doyen Retractor Blade

CODE	WIDTH	DEPTH	TOTAL LENGTH
32-3628	2 3/8 in (6.0 cm)	5 1/2 in 140 mm	11 1/2 in 292 mm



## Retractors (Hand-Held)

### US Army Retractor

CODE	DESCRIPTION	BLADE (W X D)	LENGTH
22-1821	Set of 2, Double-Ended		8 <sup>1</sup> / <sub>4</sub> in 210 mm
50-4071	Set of 2, Double-Ended	1 <sup>3</sup> / <sub>4</sub> x <sup>9</sup> / <sub>16</sub> in (44 x 14 mm) 1 <sup>1</sup> / <sub>4</sub> x <sup>9</sup> / <sub>16</sub> in (32 x 14 mm)	8 <sup>5</sup> / <sub>16</sub> in 211 mm



50-4071

### Volkman Retractor

CODE	DESCRIPTION	BLADE (W X D)	LENGTH
22-3402	2 Prong, Sharp	Standard Pattern	8 <sup>3</sup> / <sub>4</sub> in 222 mm
22-3403	3 Prong, Sharp	Standard Pattern	8 <sup>3</sup> / <sub>4</sub> in 222 mm
22-3404	4 Prong, Sharp	Standard Pattern	8 <sup>3</sup> / <sub>4</sub> in 222 mm
22-3406	6 Prong, Sharp	Standard Pattern	8 <sup>3</sup> / <sub>4</sub> in 222 mm
22-3502	2 Prong, Blunt	Standard Pattern	8 <sup>3</sup> / <sub>4</sub> in 222 mm
22-3503	3 Prong, Blunt	Standard Pattern	8 <sup>3</sup> / <sub>4</sub> in 222 mm
22-3504	4 Prong, Blunt	Standard Pattern	8 <sup>3</sup> / <sub>4</sub> in 222 mm
22-3506	6 Prong, Blunt	Standard Pattern	8 <sup>3</sup> / <sub>4</sub> in 222 mm
50-4220CO	2 Prong, Sharp	<sup>7</sup> / <sub>16</sub> x <sup>11</sup> / <sub>16</sub> in 11 x 17 mm	8 <sup>3</sup> / <sub>4</sub> in 222 mm
50-4221CO	3 Prong, Sharp	<sup>11</sup> / <sub>16</sub> x <sup>11</sup> / <sub>16</sub> in 11 x 17 mm	8 <sup>3</sup> / <sub>4</sub> in 222 mm
504222CO	4 Prong, Sharp	<sup>15</sup> / <sub>16</sub> x <sup>11</sup> / <sub>16</sub> in 24 x 17 mm	8 <sup>3</sup> / <sub>4</sub> in 222 mm
50-4223CO	6 Prong, Sharp	1 <sup>1</sup> / <sub>2</sub> x <sup>11</sup> / <sub>16</sub> in 17 x 38 mm	8 <sup>3</sup> / <sub>4</sub> in 222 mm
50-4225CO	2 Prong, Blunt	<sup>7</sup> / <sub>16</sub> x <sup>11</sup> / <sub>16</sub> in 11 x 17 mm	8 <sup>3</sup> / <sub>4</sub> in 222 mm
50-4226CO	3 Prong, Blunt	<sup>11</sup> / <sub>16</sub> x <sup>11</sup> / <sub>16</sub> in 17 x 17 mm	8 <sup>3</sup> / <sub>4</sub> in 222 mm
504227CO	4 Prong, Blunt	<sup>15</sup> / <sub>16</sub> x <sup>11</sup> / <sub>16</sub> in 24 x 17 mm	8 <sup>3</sup> / <sub>4</sub> in 222 mm
50-4228CO	6 Prong, Blunt	1 <sup>1</sup> / <sub>2</sub> x <sup>11</sup> / <sub>16</sub> in 38 x 17 mm	8 <sup>3</sup> / <sub>4</sub> in 222 mm



50-4226CO

## Retractors (Nerve Root)

### D'Errico Nerve Root Retractor

CODE	DESCRIPTION	BLADE WIDTH	LENGTH
20-1814	Bayonet	¼ in 6.0 mm	9 in 229 mm



### Holsher Nerve Root Retractor

CODE	DESCRIPTION	BLADE WIDTH	LENGTH
50-1331	Nerve Root Retractor	⅝ in 7.0 mm	9¾ in 248 mm



### Scoville Nerve Root Retractor

90° Angle

CODE	BLADE WIDTH	SHAFT LENGTH	HANDLE LENGTH
50-1291	⅝ in (8 mm)	4¼ in 108 mm	5 in 127 mm
50-1293	½ in (13 mm)	4¼ in 108 mm	5 in 127 mm



50-1291

## Retractors (Pyloric Stenosis)

### Benson Pyloric Stenosis Spreader Retractor

CODE	DESCRIPTION	LENGTH
50-5115	Stenosis Spreader	6⅛ in 156 mm





## Retractors (Renal)

### Wylie Renal Retractor

CODE	DESCRIPTION	BLADE WIDTH
54-1795	Renal Retractor	1 x 4 in 25 x 102 mm
54-1797	Renal Retractor	1 x 7 in 25 x 178 mm



54-1795

## Retractors (Renal Sinus)

### Gil-Vernet Renal Sinus Retractor

CODE	DESCRIPTION	BLADE WIDTH	LENGTH
5150-A	Renal Sinus Retractor	9.0 mm	11 ¼ in 286 mm
5150-B			11 ¼ in 286 mm
5150-C			11 ¼ in 286 mm
5150-D			11 ¼ in 286 mm



5150-D

## Retractors (Scalp)

### Contour Scalp Retractor

CODE	DESCRIPTION	LENGTH
24-2670	3 x 4 Prongs, Blunt	5 ½ in 140 mm
24-2671	3 x 4 Prongs, Sharp	5 ½ in 140 mm

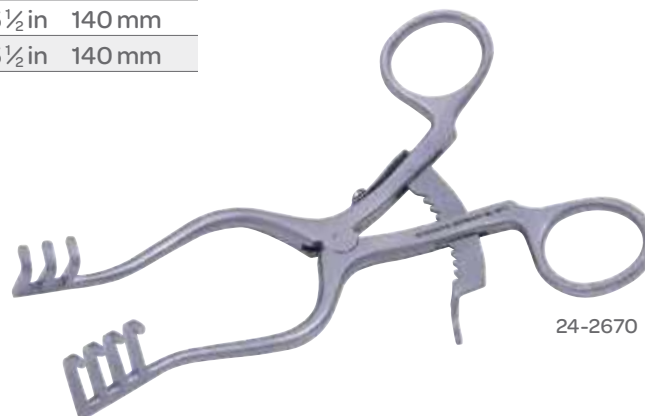

24-2670

## Retractors (Scalp)

### Jansen Scalp Retractor

CODE	DESCRIPTION	LENGTH
24-1310	3 x 3 Prongs, Sharp	4 in 102 mm
24-1320	3 x 3 Prongs, Blunt	4 in 102 mm
24-1321	4 x 4 Prongs, Blunt	4 <sup>3</sup> / <sub>8</sub> in 111 mm



24-1310

## Retractors (Self-Retaining)

### Adson 4 x 4 Retractor

4 x 4 Prongs, Sharp

CODE	DESCRIPTION	TOTAL OPENING	BLADE WIDTH	BLADE DEPTH	LENGTH
50-1180	Straight Arms, Straight Shaft	4 <sup>1</sup> / <sub>2</sub> in 114 mm	<sup>5</sup> / <sub>8</sub> in 16 mm	<sup>7</sup> / <sub>8</sub> in 22 mm	7 <sup>1</sup> / <sub>2</sub> in 191 mm
50-1182	Straight Arms, Straight Shaft	4 <sup>1</sup> / <sub>2</sub> in 114 mm	<sup>5</sup> / <sub>8</sub> in 16 mm	<sup>7</sup> / <sub>8</sub> in 22 mm	7 <sup>1</sup> / <sub>2</sub> in 191 mm
50-1181	Angled Arms, Angular Shaft	4 <sup>1</sup> / <sub>2</sub> in 114 mm	<sup>5</sup> / <sub>8</sub> in 16 mm	<sup>7</sup> / <sub>8</sub> in 22 mm	7 in 178 mm



50-1180

### Adson Retractor

CODE	DESCRIPTION	ANGLE	PRONGS	TOTAL OPENING	LENGTH
50-1362	Sharp, Curved	65°	3 x 3	5 in 127 mm	9 <sup>1</sup> / <sub>2</sub> in 241 mm



## Retractors (Self-Retaining)

### Alm Self-Retaining Retractor

CODE	DESCRIPTION	LENGTH
24-1007	4 x 4 Prongs, Sharp	2¾ in 70 mm
24-1010	4 x 4 Prongs, Sharp	4 in 102 mm
24-1008	4 x 4 Prongs, Blunt	2¾ in 70 mm
24-1011	4 x 4 Prongs, Blunt	4 in 102 mm



24-1007

### Alms Wound Retractor

CODE	DESCRIPTION	PRONG DEPTH	TOTAL OPENING	LENGTH
50-4265	Semi-Sharp Prongs	⅛ in 3.0 mm	2 in 51 mm	3 in 76 mm



### Anderson-Adson Scalp Retractor

Angular Arms

CODE	DESCRIPTION	BLADE WIDTH	BLADE DEPTH	TOTAL OPENING	LENGTH
50-1186	4 x 4 Sharp Prongs	¾ in 19 mm	⅝ in 16 mm	4½ in 114 mm	7½ in 191 mm



### Beckman Adson Retractor

CODE	DESCRIPTION	PRONGS	TOTAL OPENING	BLADE DEPTH	LENGTH
50-1165	Sharp, Self-Retaining w/ Hinged Arms	4 x 4	5½ in 140 mm	1 in 25 mm	12 in 305 mm



## Retractors (Self-Retaining)

### Beckman-Eaton Laminectomy Retractor

Self-Retaining with Hinged Arms

CODE	PRONGS	BLADE WIDTH		TOTAL OPENING		LENGTH	
50-1163	7x7	1¾ in	44 mm	5½ in	140 mm	12¾ in	324 mm



### Beckman-Adson Laminectomy Retractor

Self-Retaining with Hinged Arms

CODE	DESCRIPTION	BLADE (W X D)		TOTAL OPENING		LENGTH	
50-1160	Blunt	1 x 1¼ in	25 x 32 mm	5 in	127 mm	12 in	305 mm
50-1161	Sharp	1 in	25 mm	5 in	127 mm	12 in	305 mm
50-1162	Blunt	1 x 1 in	25 x 25 mm	5½ in	140 mm	12 in	305 mm



### Beckmann-Adson Laminectomy Retractor

Hinged Arms

CODE	DESCRIPTION	BLADE WIDTH		LENGTH	
24-3425	4 x 4 Prongs, Sharp	1 in	25 mm	12⅛ in	308 mm
24-3426	4 x 4 Prongs, Blunt	1 in	25 mm	12⅛ in	308 mm
24-3446	4 x 4 Prongs, Blunt	1¾ in	44 mm	12⅛ in	308 mm



## Retractors (Self-Retaining)

### Black 90° Dural Suction Retractor

CODE	TIP (W X D)	WORKING DISTANCE	HANDLE LENGTH
46-3012	$\frac{9}{32} \times \frac{1}{4}$ in 8.0 x 6.0 mm	4 $\frac{3}{4}$ in 120 mm	4 $\frac{5}{8}$ in 117 mm



### Charnley Retractor Blades

CODE	DESCRIPTION	SIZE
24-2012	Short Blade	1 x 1½ in 25 x 38 mm
24-2004	Short Blade	1 x 2½ in 25 x 64 mm
24-2009	Short Blade	1 x 4 in 25 x 102 mm
24-2004A	Short Blade, Angled	1 x 2½ in 25 x 64 mm
24-2009A	Short Blade, Angled	1 x 4 in 25 x 102 mm
24-2020	Rounded Tip	1½ x 2½ in 38 x 64 mm
24-2020A	Angled Tip	1½ x 2½ in 38 x 64 mm
24-2011	Long Blade	1 x 1½ in 25 x 38 mm
24-2005	Long Blade	1 x 2½ in 25 x 64 mm
24-2010	Long Blade	1 x 4 in 25 x 102 mm
24-2019	Long Blade, Rounded Tip	1 x 2 in 25 x 51 mm
24-2019A	Long Blade, Angled Tip	1 x 2 in 25 x 51 mm
24-2005A	Long Blade, Angled	1 x 2½ in 25 x 64 mm
24-2010A	Long Blade, Angled	1 x 4 in 25 x 102 mm



24-2009

## Retractors (Self-Retaining)

### Charnley Initial Incision Retractor

CODE	DESCRIPTION
24-2000	Complete set
24-2000C	Chain
24-2000CW	Chain with Weight

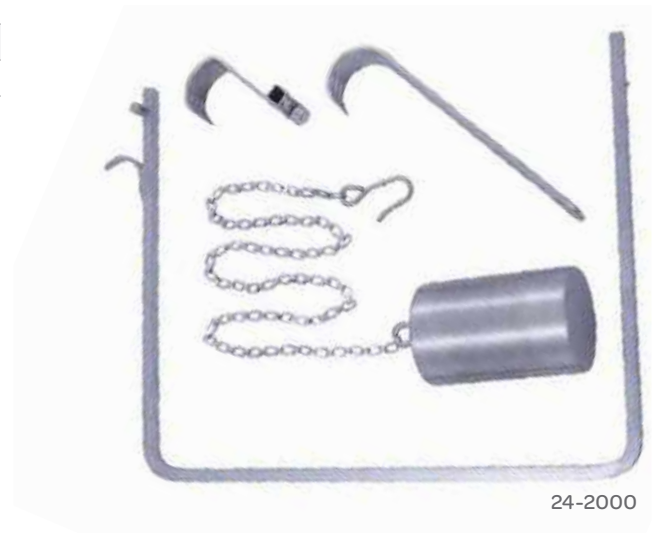

### Cone Scalp Retractor

With Hinged Arms

CODE	DESCRIPTION	LENGTH
50-1166	3 x 4 Prongs, Blunt	5 3/4 in 146 mm



### Cone Laminectomy Retractor

Self-Retaining, Hinged Arms

CODE	DESCRIPTION	LENGTH
50-1167	3 x 4 Prongs, Sharp	6 3/8 in 162 mm
50-1168	3 x 4 Prongs, Sharp	8 in 203 mm



## Retractors (Self-Retaining)

### Contour Scalp Retractor

Self-Retaining, with Blades Curved to Fit Contour of Skull

CODE	DESCRIPTION	BLADE (W X D)	TOTAL OPENING	LENGTH
50-1220	3 x 4 Prongs, Blunt	$\frac{5}{8}$ x $\frac{5}{8}$ in 16 x 16 mm	2 $\frac{1}{2}$ in 64 mm	5 $\frac{1}{2}$ in 140 mm



### Gelpi Perineal Retractor

CODE	DESCRIPTION	TOTAL OPENING	LENGTH
50-1210	Self-Retaining	3 $\frac{3}{4}$ in 95 mm	7 $\frac{1}{4}$ in 184 mm



### Gelpi Retractor

CODE	DESCRIPTION	LENGTH	CODE	DESCRIPTION	LENGTH	WIDTH
24-4013		3 $\frac{1}{2}$ in 89 mm	24-4017	Tips Bent 90°	6 $\frac{3}{4}$ in	171 mm
24-4015		4 $\frac{1}{2}$ in 114 mm	24-4057	With Ball Stops	7 $\frac{1}{2}$ in	191 mm
24-4018		6 $\frac{3}{4}$ in 121 mm				



24-4013

### Jansen Mastoid Retractor

Self-Retaining

CODE	DESCRIPTION	PRONG (W X D)	TOTAL OPENING	LENGTH
50-1227	3 x 3 Prongs, Blunt	$\frac{1}{16}$ x $\frac{3}{8}$ in (17 x 10 mm)	1 $\frac{3}{4}$ in 44 mm	4 in 102 mm



## Retractors (Self-Retaining)

### Jansen Scalp Retractor

Self-Retaining, Blunt

CODE	DESCRIPTION	PRONG (W X D)	BLADE WIDTH	BLADE DEPTH	TOTAL OPENING	LENGTH
50-1226	4 x 4 Prongs	$\frac{3}{4} \times \frac{3}{8}$ in 19 x 10 mm	$\frac{3}{4}$ in 19 mm	$\frac{3}{4}$ in 19 mm	3 in 76 mm	4 $\frac{5}{8}$ in 117 mm



### Markham-Meyerding Hemilaminectomy Retractor

Self-Retaining

CODE	DESCRIPTION	BLADE WIDTH	BLADE DEPTH	TOTAL OPENING	TOTAL LENGTH
50-1205	Left	1 in 25 mm	2 in 51 mm	3 $\frac{3}{4}$ in 95 mm	7 in 178 mm
50-1206	Right	1 in 25 mm	2 in 51 mm	3 $\frac{3}{4}$ in 95 mm	7 in 178 mm



50-1205

### Microvascular Modified Alm Retractor

Black Anodized

CODE	DESCRIPTION	LENGTH
80-1812	4 x 4 Prongs	3 in 76 mm
80-1813	12 x 12 Prongs	3 $\frac{3}{4}$ in 95 mm



80-1813

### Miskimon Cerebellar Retractor

CODE	DESCRIPTION	BLADE (W X D)	LENGTH
50-1363	7 x 7 Prongs, Sharp	1 $\frac{1}{4}$ x 1 $\frac{3}{8}$ in (32 x 35 mm)	7 $\frac{1}{2}$ in 191 mm





## Retractors (Self-Retaining)

### Meyerding Laminectomy Retractor

CODE	DESCRIPTION	BLADE WIDTH	BLADE DEPTH	TOTAL OPENING	TOTAL OPENING
50-1191	Self-Retaining	1 in 25 mm	2 in 51 mm	3¾ in 95 mm	6½ in 165 mm



### Poppen-Gelpi Laminectomy Retractor

CODE	DESCRIPTION	TOTAL OPENING	LENGTH
50-1212	Self-Retaining	2½ in 64 mm	5½ in 140 mm



## Tissue Retractors

### Blunt

CODE	DESCRIPTION	PRONG (W X D)	TOTAL OPENING	LENGTH
50-1223	3 x 3 Prongs	½ x 5/8 in 13 x 16 mm	2½ in 64 mm	5¼ in 133 mm
50-1224	1 x 1 Prong	½ in 13 mm	2½ in 64 mm	5¼ in 133 mm



50-1223

## Retractors (Self-Retaining)

### Seletz-Gelpi Laminectomy Retractor

With Arms Bent at Right Angles

CODE	DESCRIPTION	ARM LENGTH,	TOTAL OPENING	LENGTH
50-1211	Self-Retaining	2 <sup>9</sup> / <sub>16</sub> in 65 mm	3 <sup>3</sup> / <sub>4</sub> in 95 mm	6 <sup>1</sup> / <sub>4</sub> in 159 mm



### Snitman Endaural Retractor

Self-Retaining

CODE	DESCRIPTION	PRONG (W X D)	TOTAL OPENING	LENGTH
50-1236	3 x 3 Prongs, Sharp	<sup>9</sup> / <sub>16</sub> x <sup>3</sup> / <sub>8</sub> in 14 x 10 mm	2 in 51 mm	4 <sup>3</sup> / <sub>16</sub> in 106 mm

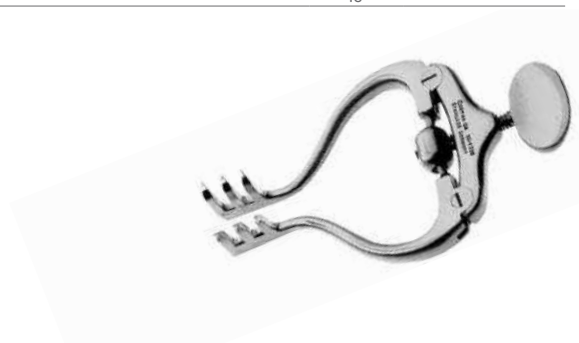

### Weitlaner Retractor

CODE	DESCRIPTION	LENGTH
24-2210	2 x 3 Prongs, Sharp	4 <sup>1</sup> / <sub>2</sub> in 114 mm
24-2213	3 x 4 Prongs, Sharp	5 <sup>1</sup> / <sub>2</sub> in 140 mm
24-2216	3 x 4 Prongs, Sharp	6 <sup>1</sup> / <sub>2</sub> in 165 mm
24-2220	3 x 4 Prongs, Sharp	8 in 203 mm
24-2224	3 x 4 Prongs, Sharp	9 in 229 mm
24-2211	2 x 3 Prongs, Blunt	4 <sup>1</sup> / <sub>2</sub> in 114 mm
24-2214	3 x 4 Prongs, Blunt	5 <sup>1</sup> / <sub>2</sub> in 140 mm
24-2217	3 x 4 Prongs, Blunt	6 <sup>1</sup> / <sub>2</sub> in 165 mm
24-2221	3 x 4 Prongs, Blunt	8 in 203 mm
24-2225	3 x 4 Prongs, Blunt	9 in 229 mm

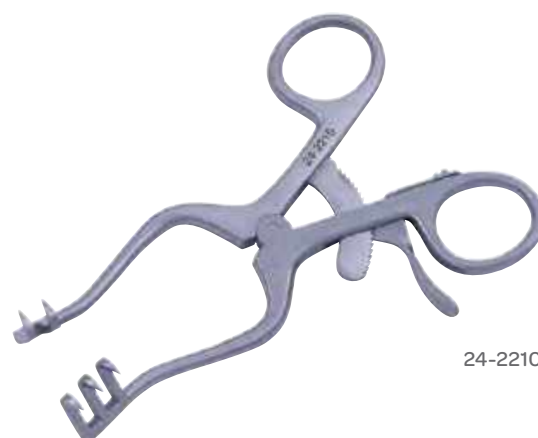

24-2210

## Retractors (Self-Retaining)

### Weitlaner Retractor

Self-Retaining Prongs

CODE	DESCRIPTION	TOTAL OPENING	LENGTH
50-5646	2 X 3 Prongs, Sharp	2¼ in 57 mm	4½ in 114 mm
50-1194	3 x 4 Prongs, Sharp	2¼ in 57 mm	5½ in 140 mm
50-1196	3 x 4 Prongs, Sharp	4 in 102 mm	6½ in 165 mm
50-1198	3 x 4 Prongs, Sharp	5 in 127 mm	7½ in 191 mm
50-1200	3 X 4 Prongs, Sharp	5¾ in 146 mm	9 in 229 mm
50-5646	2 X 3 Prongs, Blunt	2¼ in 57 mm	4½ in 114 mm
50-1195	3 x 4 Prongs, Blunt	2¼ in 57 mm	5½ in 140 mm
50-1197	3 x 4 Prongs, Blunt	4 in 102 mm	6½ in 165 mm
50-1199	3 x 4 Prongs, Blunt	5 in 127 mm	7½ in 191 mm
50-1201	3 X 4 Prongs, Blunt	5¾ in 146 mm	9 in 229mm

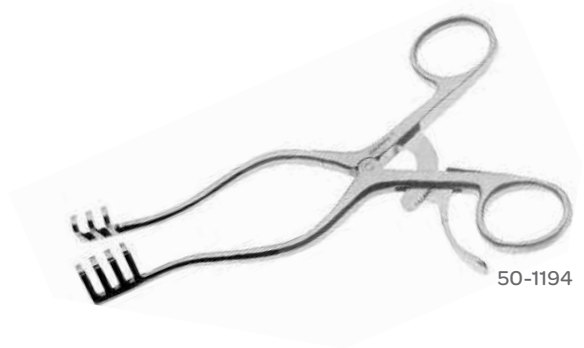

50-1194

### Weitlaner-Beckmann Retractor

Hinged Arms

CODE	DESCRIPTION	LENGTH
24-3014	3 x 4 Prongs, Blunt	5½ in 140 mm
24-3017	3 x 4 Prongs, Blunt	6½ in 165 mm
24-3021	3 x 4 Prongs, Blunt	8½ in 216 mm
24-3024	3 x 4 Prongs, Blunt	9½ in 241 mm
24-3023	3 x 4 Prongs, Sharp	9½ in 241 mm

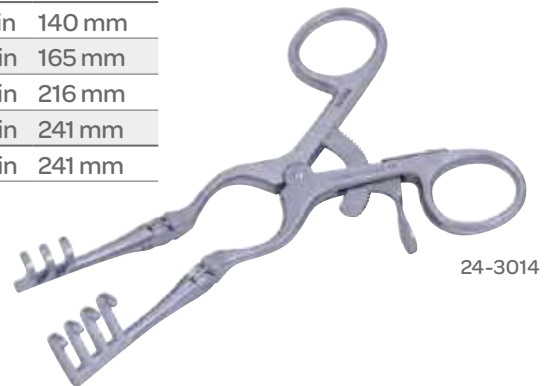

24-3014

### Wiltse-Gelpi Retractor

Deep Blades

CODE	DESCRIPTION	LENGTH
24-4760	1x1 Prongs, Sharp	11 in 279 mm



## Retractors (Spring)

### Farr Spring Retractor

CODE	PRONG	LENGTH
24-0307	1 in 25 mm	5 ½ in 140 mm
24-0306	1 in 25 mm	9 in 229 mm

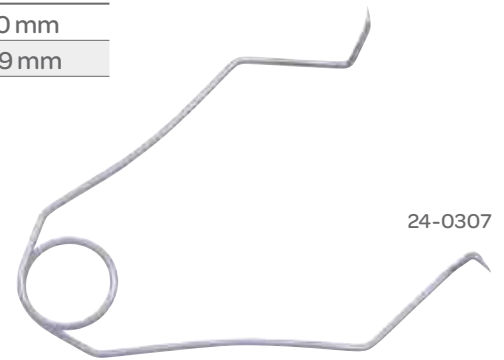

24-0307

### Spring Retractor

CODE	DESCRIPTION	BLADE LENGTH (W X D)	LENGTH
50-4350	1 Prong, Sharp	¾ in 10 mm	3 ½ in 79 mm
50-4351	3 Prong, Semi-Sharp	7/16 x 9/16 in 11 x 14 mm	3 ¼ in 83 mm

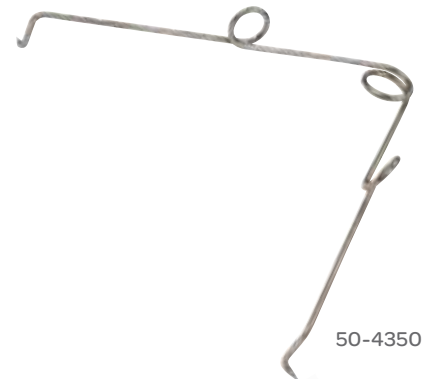

50-4350

### Spring Retractor

CODE	DESCRIPTION	LENGTH
24-0300	1x1 Prong, Sharp	2 ½ in 64 mm
24-0301	1x1 Prong, Sharp	3 ½ in 89 mm
24-0352	1x1 Prong, Sharp	4 ½ in 105 mm
24-0302	1x1 Prong, Sharp	4 ½ in 114 mm
24-0327	1x1 Prong, Sharp	
24-0303	3 x 3 Prongs, Blunt	3 ½ in 89 mm
24-0304	3 x 3 Prongs, Blunt	4 ½ in 114 mm

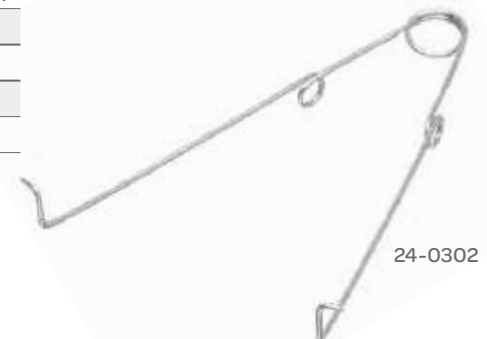

24-0302

## Retractors (Thyroid)

### Mahorner Thyroid Retractor

CODE	DESCRIPTION	LENGTH
24-0888	7 Prong	10½ in 267 mm

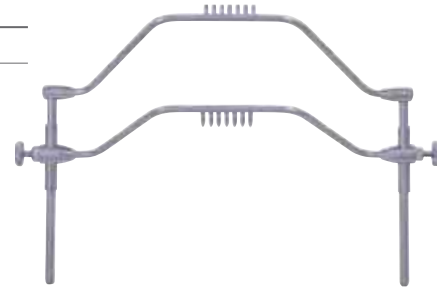

### McBurney Thyroid Retractor

CODE	DESCRIPTION	LENGTH
20-1782	Fenestrated	7½ in 191 mm



## Retractors (Tracheal)

### News Tracheal Hook Retractor

CODE	DESCRIPTION	LENGTH
20-4015	1 Prong, Sharp	6 in 152 mm



## Retractors (Vagotomy)

### Weinberg Vagotomy Retractor

CODE	DESCRIPTION	DIMENSIONS	LENGTH
23-5917	Double-Ended	2 x 2½ in 51 x 38 mm	3½ in x 6¼ in 89 x 159 mm
			9½ in 241 mm



## Retractors (Vein)

### Cushing Vein Retractor

CODE	WIDTH	LENGTH
20-1710	10 mm	8 in 203 mm
20-1712	12 mm	8 in 203 mm
20-1714	14 mm	8 in 203 mm
20-1718	18 mm	8 in 203 mm
20-1728	8.0 mm	9½ in 241 mm
20-1730	10 mm	9½ in 241 mm
20-1732	12 mm	9½ in 241 mm
20-1736	16 mm	9½ in 241 mm



20-1710

## Rings

### Laparotomy Ring

CODE	DIAMETER
01-1004	2 in 51 mm



## Ring Cutters

### Ring Cutter

CODE	DESCRIPTION
43-4500	Finger Ring Cut Economy
43-4501	Finger Ring Cutter, Saw Blade Only for 43-4500
43-4600	Finger Ring Cutter with Plier Handle



43-4500

## Rulers

### Measuring Tape

CODE	DESCRIPTION
44-3515	Tape Measure in Inches and Centimeters Up to 150 cm/5 ft



44-3515

### Ruler

CODE	DESCRIPTION	LENGTH
44-3715	Stainless Steel	6 in 152 mm
44-3720	Stainless Steel	8 in 203 mm
44-3730	Stainless Steel	11 3/4 in 298 mm



44-3715

## Scissors (Abdominal)

### Doyen Abdominal Scissors

CODE	DESCRIPTION	LENGTH
54-4080C	Straight	7 in 178 mm



### Fergusson Abdominal Scissors

CODE	DESCRIPTION	LENGTH
54-4085C	Angled On Flat	7 1/4 in 184 mm



## Scissors (Angled)

### Wilmer Angled Scissors

CODE	DESCRIPTION	LENGTH
60-1850	Angled On Flat	4 in 102 mm



## Scissors (Artery)

### Coronary Artery Scissors

Angled, Flat Handle

CODE	DESCRIPTION	LENGTH
55-8601	25°	6¾ in 171 mm
55-8602	45°	6¾ in 171 mm
55-8603	60°	6¾ in 171 mm
55-8604	90°	6¾ in 171 mm
55-8605	120°	6¾ in 171 mm



55-8601

### Coronary Artery Scissors

Angled, Flat Handle, Ball Tip

CODE	DESCRIPTION	LENGTH
55-8501	25°	6¾ in 171 mm
55-8504	90°	6¾ in 171 mm
55-8502	45°	6¾ in 171 mm
55-8503	60°	6¾ in 171 mm
55-8505	120°	6¾ in 171 mm



55-8501



## Scissors (Artery)

### Dietrich Coronary Artery Scissors

Angled

CODE	DESCRIPTION	BLADE LENGTH	BLADE WIDTH	LENGTH
54-8017	25°	½ in 13 mm	⅛ in 3.0 mm	7 in 178 mm
54-8018	45°	½ in 13 mm	⅛ in 3.0 mm	7 in 178 mm
54-8019	60°	½ in 13 mm	⅛ in 3.0 mm	7 in 178 mm
54-8021	90°	½ in 13 mm	⅛ in 3.0 mm	7 in 178 mm
54-8020	120°, with Stabilizer Bar	½ in 13 mm	⅛ in 3.0 mm	7 in 178 mm



54-8020

## Scissors (Bandage)

### Bandage Scissors

CODE	DESCRIPTION	LENGTH
40-5322	One Blade Serrated	9 in 229 mm

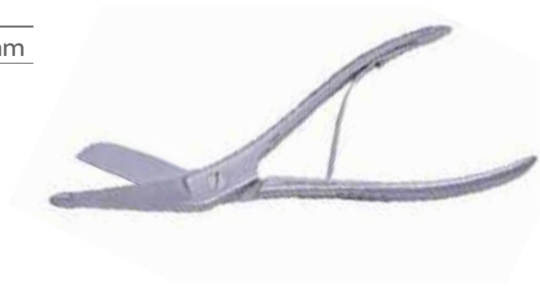

### Lister Bandage Scissors

CODE	DESCRIPTION	LENGTH
40-2514	Standard Finger Rings	5½ in 140 mm
54-4012	Standard Finger Rings	5¾ in 146 mm
40-2518	Standard Finger Rings	7⅛ in 181 mm
54-4013	Standard Finger Rings	7¼ in 184 mm
40-2520	Standard Finger Rings	8 in 203 mm
54-4192	One Large Ring	7½ in 191 mm
40-5550	Large Finger Rings	8 in 203 mm



54-4013

### Lister Serrated Bandage Scissors

Angled, One Blade Serrated, with Black Handles

CODE	LENGTH
86-2518	7 in 178 mm
86-4520	8 in 203 mm



86-2518

## Scissors (Bandage)

### Universal Bandage Scissors

Plastic Handle

CODE	DESCRIPTION	LENGTH
40-4718	Black	7 $\frac{1}{8}$ in 181 mm
40-4719	Red	7 $\frac{1}{8}$ in 181 mm
40-4720	Dark Blue	7 $\frac{1}{8}$ in 181 mm
40-4721	Green	7 $\frac{1}{8}$ in 181 mm
40-4722	Orange	7 $\frac{1}{8}$ in 181 mm
40-4723	Yellow	7 $\frac{1}{8}$ in 181 mm
40-4724	Burgundy	7 $\frac{1}{8}$ in 181 mm
40-4725	Pink	7 $\frac{1}{8}$ in 181 mm
40-4726	Purple	7 $\frac{1}{8}$ in 181 mm
40-4727	Neon Green	7 $\frac{1}{8}$ in 181 mm
40-4728	White	7 $\frac{1}{8}$ in 181 mm
40-4729	Light Blue	7 $\frac{1}{8}$ in 181 mm



## Scissors (Bandage & Plastic)

### Bergmann Bandage Scissors

CODE	DESCRIPTION	LENGTH
40-3323	Heavy	9 $\frac{1}{2}$ in 241 mm



### Esmarch Bandage Scissors

CODE	LENGTH
40-3120	8 in 203 mm



## Scissors (Crown & Collar)

### Crown & Collar Scissors

Straight

CODE	DESCRIPTION	LENGTH
14-2610	Smooth Blade	4 in 102 mm



## Scissors (Delicate)

### Fine Scissors

Sharp/Sharp

CODE	DESCRIPTION	LENGTH
54-1075	Straight	4 ½ in 114 mm
54-1076	Curved	4 ½ in 114 mm



54-1075

### Kaye Scissors

One Blade Serrated, Tungsten Carbide Cutting Edges, Outer Edges Semi-Sharp

CODE	DESCRIPTION	LENGTH
32-690	Curved	4 ½ in 114 mm
32-697	Curved	7 in 178 mm



32-697

## Scissors (Delicate)

### Kaye Ceramic Coated Scissors

Razor Edge with Micro-Serrations On One Blade, Tungsten Carbide Cutting Edges, Black Ceramic Coating

CODE	DESCRIPTION	LENGTH
224.77.69	Curved	7½ in 191 mm



### Par Scissors

Blunt, Tungsten Carbide Cutting Edges

CODE	DESCRIPTION	LENGTH
32-930	Curved	4¾ in 121 mm
32-931	Curved	5¾ in 146 mm



32-930

### Par Razor Edge Scissors

Micro Serrations, Black Handle

CODE	DESCRIPTION	LENGTH
80-2180	Straight	4½ in 114 mm
80-2185	Curved	4½ in 114 mm



80-2180

### Wagner Scissors

Straight, Fine Tips

CODE	DESCRIPTION	LENGTH
02-0612	Sharp/Sharp	4¾ in 121 mm
02-0632	Sharp/Blunt	4¾ in. 121 mm



02-0612

## Scissors (Dissecting)

### Metzenbaum Dissecting Scissors

Regular Tips, Tungsten Carbide Cutting Edges

CODE	DESCRIPTION	LENGTH
32-720	Straight	5¾ in 146 mm
32-710	Curved	5¾ in 146 mm

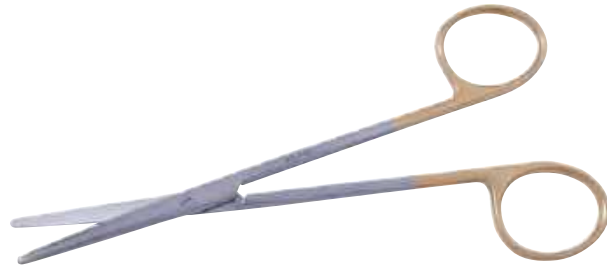

32-720

### Classic® Mayo Scissors

Round Blades

CODE	DESCRIPTION	LENGTH
34-4092	Straight	6¾ in 171 mm
34-4097	Curved	6¾ in 171 mm



34-4092

### Cottle Micro-Serrated Scissors

One Blade Serrated, Gold Screw

CODE	DESCRIPTION	LENGTH
267.53.16	Angled	6¼ in 159 mm



### Dandy Trigeminal Scissors

Angled Shaft, Curved Tips

CODE	DESCRIPTION	LENGTH
54-1041	Sharp	7¾ in 197 mm



## Scissors (Dissecting)

### Delicate Dissecting Scissors

CODE	DESCRIPTION	LENGTH
54-5566	Curved	5 in 127 mm



### Delicate Scissors

CODE	DESCRIPTION	LENGTH
54-2515	Straight, Blunt/Blunt	4½ in 114 mm
54-5567	Curved with Dissecting End	4⅞ in 124 mm



54-2515

### Demartel Scissors

Extra Delicate, Sharp Tips

CODE	DESCRIPTION	LENGTH
04-7018	Straight	6¾ in 171 mm



### Dissecting Scissors

Extra Delicate, Sharp Tips

CODE	DESCRIPTION	LENGTH
02-5062	Straight, with Probe	4⅛ in 105 mm
02-5063	Curved, Ball Tip	4⅛ in 105 mm
02-5065	Angled, Ball Tip	4⅛ in 105 mm



02-5062

## Scissors (Dissecting)

### Dissecting Scissors, Serrated

One Blade Serrated

CODE	DESCRIPTION	LENGTH
85-2016	Straight	4 <sup>3</sup> / <sub>4</sub> in 121 mm
85-2017	Curved	4 <sup>3</sup> / <sub>4</sub> in 121 mm



85-2017

### Fomon Micro-Serrated Scissors

One Blade Serrated, Gold Screw

CODE	DESCRIPTION	LENGTH
267.53.13	Angled	5 <sup>1</sup> / <sub>2</sub> in 140 mm



### Gorney Ceramic Coated Scissors

Razor Edge with Micro-Serrations On One Blade, Tungsten Carbide Cutting Edges, Black Ceramic Coating

CODE	DESCRIPTION	LENGTH
224.73.69	Curved	7 <sup>1</sup> / <sub>2</sub> in 191 mm



### Iris Ceramic Coated Scissors

One Blade Serrated, Tungsten Carbide Cutting Edges, Black Ceramic Coating

CODE	DESCRIPTION	LENGTH
222.20.61	Straight	4 <sup>1</sup> / <sub>2</sub> in 114 mm



## Scissors (Dissecting)

### Jameson Reynolds Ceramic Coated Scissors

One Blade with Micro-Serrations, Tungsten Carbide Cutting Edges, Black Ceramic Coating

CODE	DESCRIPTION	LENGTH
224.67.66	Curved	6 ¼ in 159 mm
224.67.68	Curved	7 in 176 mm



224.67.68

### Jameson Reynolds Micro-Serrated Scissors

One Blade Serrated, Gold Screw

CODE	DESCRIPTION	LENGTH
204.67.12	Curved, Slim Pattern	4 ¾ in 121 mm
204.67.16	Curved	6 ¼ in 159 mm



204.67.12

### Jameson Metzenbaum Tenotomy Scissors

One Blade Serrated, Gold Screw

CODE	DESCRIPTION	LENGTH
37-4033	Curved	6 in 152 mm
37-4031	Curved	8 in 203 mm
37-4027	Curved	9 in 229 mm



37-4027

### Jameson Reynolds Razor Edge Scissors

One Blade with Micro-Serrations, Black Handle with Gold Screw

CODE	DESCRIPTION	LENGTH
214.67.12	Curved	4 ¾ in 121 mm
214.67.16	Curved	6 ¼ in 159 mm
214.68.18	Curved	7 ⅛ in 181 mm



214.67.16



## Scissors (Dissecting)

### Jorgenson Dissecting Scissors

CODE	DESCRIPTION	LENGTH
54-4151	Stronge Curve	8½ in 216 mm
54-4023	Strong Curve, Rounded Tips	9 in 229 mm



54-4023

### Joseph Serrated Scissors

One Blade Serrated, with Black Handles

CODE	DESCRIPTION	LENGTH
86-5015	Straight	6 in 152 mm
86-5115	Curved	6 in 152 mm



86-5015

### Joseph Razor Edge Scissors

One Blade with Micro-Serrations, Black Handle with Gold Screw

CODE	DESCRIPTION	LENGTH
214.50.15	Straight	5¾ in 146 mm
214.51.15	Curved	5¾ in 146 mm



214.50.15

### Joseph Razor Edge Serrated Scissors

One Blade Serrated, Gold Screw

CODE	DESCRIPTION	LENGTH
204.51.15	Curved	5¾ in 146 mm



## Scissors (Dissecting)

### Knapp Dissecting Scissors

Rounded Blades

CODE	DESCRIPTION	LENGTH
02-4010	Straight	4 in 102 mm
02-4110	Curved	4 in 102 mm



02-4110

### Lahey Scissors

Delicate Pattern, Rounded Blades

CODE	DESCRIPTION	LENGTH
54-5571	Curved	5¾ in 146 mm



### Lincoln Scissors

Very Delicate, Sharp Tips, Rounded Blades

CODE	DESCRIPTION	LENGTH
55-2270	Straight	7 in 178 mm
55-2280	Curved	7 in 178 mm

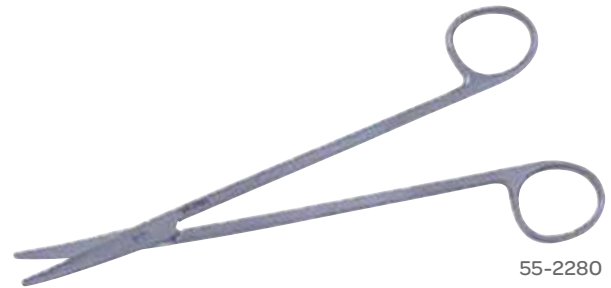

55-2280

### MagnaFree® MRI Mayo Scissors

Non-Magnetic (Titanium) for Intraoperative MRI

CODE	DESCRIPTION	LENGTH
65-2416	Straight	6¾ in 171 mm



## Scissors (Dissecting)

### Mayo Carroll Scissors

Tungsten Carbide Cutting Edges

CODE	DESCRIPTION	LENGTH
32-860	Curved, Smooth Blades	9 in 229 mm



### Mayo Dissecting Scissors, Curved

CODE	DESCRIPTION	LENGTH
03-5114	Beveled Blades	5 3/4 in 146 mm
03-5117	Beveled Blades	6 3/4 in 171 mm
03-5123	Beveled Blades	9 in 229 mm
03-5132	Beveled Blades	12 in 305 mm
03-5130	Beveled Blades	14 in 356 mm
03-5145	Beveled Blades	18 in 455 mm



03-5117

### Mayo Dissecting Scissors, Curved

Fine Tungsten Carbide Cutting Edges

CODE	DESCRIPTION	LENGTH
32-652	Blade Serrated, Rounded Blades	6 in 152 mm
32-682	Blade Serrated, Rounded Blades	6 3/4 in 171 mm
32-801	Rounded Blades	5 1/2 in 140 mm
32-821	Rounded Blades	6 3/4 in 171 mm

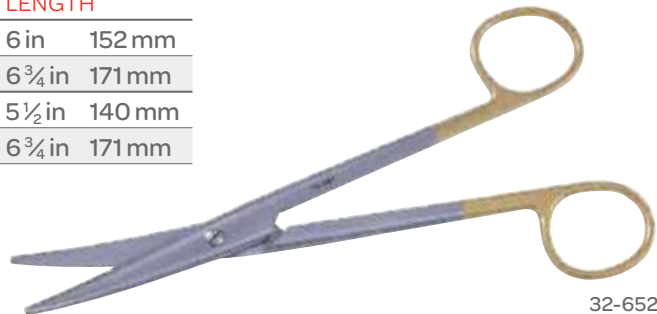

32-652

### Mayo Dissecting Scissors, Curved

Fine Tungsten Carbide Cutting Edges

CODE	DESCRIPTION	LENGTH
32-800	Beveled Blades	5 1/2 in 140 mm
32-820	Beveled Blades	6 3/4 in 171 mm
32-836	Beveled Blades	18 in 455 mm
32-820L	Beveled Blades, Left Hander	6 3/4 in 171 mm



32-800

## Scissors (Dissecting)

### Mayo Dissecting Scissors, Straight

Fine Tungsten Carbide Cutting Edges

CODE	DESCRIPTION	LENGTH
32-811	Rounded Blades	5½ in 140 mm
32-831	Rounded Blades	6¾ in 171 mm
32-810	Beveled Blades	5½ in 140 mm
32-830	Beveled Blades	6¾ in 171 mm
32-830L	Beveled Blades, Left Hand Pattern	6¾ in 171 mm



32-831

### Mayo Dissecting Scissors, Straight, Rounded Blade

Fine Tungsten Carbide Cutting Edges

CODE	DESCRIPTION	LENGTH
32-653	One Blade Serrated	5½ in 140 mm
32-683	One Blade Serrated	6¾ in 171 mm



32-653

### Mayo Dissecting Scissors, Straight

Stainless Steel

CODE	DESCRIPTION	LENGTH
03-5014	Beveled Blades	5¾ in 146 mm
03-5017	Beveled Blades	6¾ in 171 mm
03-5023	Beveled Blades	9 in 229 mm
03-5040	Beveled Blades	16 in 406 mm
03-5045	Beveled Blades	18 in 488 mm



03-5017

### Mayo Dissecting Scissors

Beveled Blades

CODE	DESCRIPTION	LENGTH
54-4090	Straight	6¾ in 171 mm



## Scissors (Dissecting)

### Mayo Classic® Dissecting Scissors

Stellite Edge Inserts, Rounded Edges

CODE	DESCRIPTION	LENGTH
36-5050	Straight	5½ in 140 mm
36-5051	Straight	6¾ in 171 mm
36-5052	Straight	9 in 229 mm
36-5060	Curved	5½ in 140 mm
36-5061	Curved	6¾ in 171 mm
36-5062	Curved	9 in 229 mm



36-5050

### Mayo Dissecting Scissors

CODE	DESCRIPTION	LENGTH
54-4088	Straight, Round Blades	5¾ in 146 mm
54-4092	Straight, Round Blades	6¾ in 171 mm
54-4098	Straight, Beveled Blades	5½ in 140 mm
54-5535	Straight, Beveled Blades	9 in 229 mm
54-4097	Curved, Round Blades	6¾ in 171 mm
54-4095	Curved, Beveled Blades	6¾ in 171 mm
54-4099	Curved, Beveled Blades	5½ in 140 mm
54-4105	Curved, Beveled Blades	9 in 229 mm



54-4088

### Mayo Harrington Serrated Scissors

One Blade Serrated, with Black Handles

CODE	DESCRIPTION	LENGTH
86-5323	Curved	9 in 229 mm



## Scissors (Dissecting)

### Mayo Ceramic Coated Scissors

Razor Edge with Micro-Serrations on One Blade, Beveled Edges Fine Tungsten Carbide Cutting Edges, Black Ceramic Coating

CODE	DESCRIPTION	LENGTH
223.50.67	Straight	6 <sup>3</sup> / <sub>4</sub> in 171 mm
223.51.64	Curved	5 <sup>1</sup> / <sub>2</sub> in 140 mm
223.51.67	Curved	6 <sup>3</sup> / <sub>4</sub> in 171 mm
223.51.73	Curved	9 in 229 mm



223.50.67

### Mayo Serrated Scissors

One Blade Serrated

CODE	DESCRIPTION	LENGTH
85-2042	Straight	5 <sup>1</sup> / <sub>2</sub> in 140 mm
85-2043	Straight	6 <sup>3</sup> / <sub>4</sub> in 171 mm
85-2044	Straight	9 in 229 mm
85-2046	Curved	6 <sup>3</sup> / <sub>4</sub> in 171 mm



85-2044

### Mayo Serrated Scissors

One Blade Serrated, Beveled Edges

CODE	DESCRIPTION	LENGTH
86-5014	Straight, w/Black Handles	5 <sup>1</sup> / <sub>2</sub> in 140 mm
86-5017	Straight, w/Black Handles	6 <sup>3</sup> / <sub>4</sub> in 171 mm
86-5023	Straight, w/Black Handles	9 in 229 mm
86-5114	Curved, w/Black Handles	5 <sup>1</sup> / <sub>2</sub> in 140 mm
86-5117	Curved, w/Black Handles	6 <sup>3</sup> / <sub>4</sub> in 171 mm
86-5123	Curved, w/Black Handles	9 in 229 mm



86-5023

## Scissors (Dissecting)

### Mayo Micro-Serration Razor Edge Scissors

One Blade with Micro-Serrations, Beveled Blades, Black Handle with Gold Screw

CODE	DESCRIPTION	LENGTH
213.50.17	Straight	6 <sup>7</sup> / <sub>8</sub> in 175 mm
213.51.17	Curved	6 <sup>3</sup> / <sub>4</sub> in 171 mm
213.51.23	Curved	9 in 229 mm



213.50.17

### Mayo Micro-Serration Razor Edge Scissors

Razor Edge Blades, Black Handle

CODE	DESCRIPTION	LENGTH
80-5017	Straight	6 <sup>3</sup> / <sub>4</sub> in 171 mm
80-5117	Curved	6 <sup>3</sup> / <sub>4</sub> in 171 mm
80-5023	Straight	9 in 229 mm
80-5123	Curved	9 in 229 mm



80-5017

### Mayo Razor Edge Serrated Scissors

One Blade Serrated, Gold Screw, Beveled Blades

CODE	DESCRIPTION	LENGTH
203.50.14	Straight	5 <sup>1</sup> / <sub>2</sub> in 140 mm
203.50.17	Straight	6 <sup>3</sup> / <sub>4</sub> in 171 mm
203.51.17	Curved	6 <sup>3</sup> / <sub>4</sub> in 171 mm
203.51.23	Curved	9 in 229 mm



203.50.14

## Scissors (Dissecting)

### Mayo-Harrington Dissecting Scissors

Slender Pattern

CODE	DESCRIPTION	LENGTH
03-5220	Straight	8 in 203 mm
03-5223	Straight	9 in 229 mm
03-5226	Straight	11½ in 292 mm



### Mayo-Harrington Dissecting Scissors

Slender Pattern

CODE	DESCRIPTION	LENGTH
03-5320	Curved	8 in 203 mm
03-5323	Curved	9 in 229 mm
03-5326	Curved	11½ in 292 mm
03-5330	Curved	14 in 356 mm



### Mayo-Harrington Scissors

Slender Pattern

CODE	DESCRIPTION	LENGTH
32-3592	Straight	14 in 356 mm
32-3593	Curved	14 in 356 mm



### Mayo-Stille Dissecting Scissors

Rounded Blades

CODE	DESCRIPTION	LENGTH
03-5615	Straight,	6 in 152 mm
03-5617	Straight	6¾ in 171 mm
03-5715	Curved	6 in 152 mm
03-5717	Curved	6¼ in 159 mm





## Scissors (Dissecting)

### Mayo-Noble Dissecting Scissors

CODE	DESCRIPTION	LENGTH
03-5817	Straight, Beveled Blades	6 in 152 mm
54-4075	Straight, Beveled Blades	6 <sup>3</sup> / <sub>4</sub> in 171 mm
54-4076	Curved, Beveled Blades	6 <sup>1</sup> / <sub>4</sub> in 159 mm



03-5817

### Mayo-Stille Micro-Serration Razor Edge Scissors

One Blade with Micro-Serrations, Rounded Blades, Black Handle with Gold Screw

CODE	DESCRIPTION	LENGTH
213.56.15	Straight	5 <sup>7</sup> / <sub>8</sub> in 149 mm
213.56.17	Straight	6 <sup>3</sup> / <sub>4</sub> in 171 mm
213.57.17	Straight	6 <sup>3</sup> / <sub>4</sub> in 171 mm



213.56.15

### Mayo-Stille Ceramic Coated Scissors

Razor Edge with Micro-Serrations on One Blade, Tungsten Carbide Cutting Edges, Black Ceramic Coating

CODE	DESCRIPTION	LENGTH
223.56.67	Curved	6 <sup>3</sup> / <sub>4</sub> in 171 mm
223.57.67	Straight	6 <sup>3</sup> / <sub>4</sub> in 171 mm



223.57.67

### Mayo-Stille Serrated Scissors

One Blade Serrated

CODE	DESCRIPTION	LENGTH
85-2049	Straight	6 <sup>3</sup> / <sub>4</sub> in 171 mm



## Scissors (Dissecting)

### Metzenbaum Ceramic Coated Scissors

Razor Edge with Micro-Serrations on One Blade, Tungsten Carbide Cutting Edges, Black Ceramic Coating

CODE	DESCRIPTION	LENGTH
224.32.64	Straight	5½ in 140 mm
224.32.68	Straight	7⅛ in 181 mm
224.33.64	Curved	5⅝ in 143 mm
224.33.68	Curved	7 in 176 mm
224.33.70	Curved	8 in 203 mm
224.33.73	Curved	9 in 229 mm



224.32.64

### Metzenbaum Scissors

Rounded Blades

CODE	DESCRIPTION	LENGTH
04-3414	Straight, Delicate Pattern	5¾ in 146 mm
04-3514	Curved, Delicate Pattern	5¾ in 146 mm
04-3518	Curved, Delicate Pattern	7 in 178 mm
54-5573	Curved, Delicate Pattern	7 in 178 mm
04-3526	Curved, Delicate Pattern	10 in 254 mm
04-3214	Straight, Standard Pattern	5¾ in 146 mm
04-3218	Straight, Standard Pattern	7 in 178 mm
04-3314	Curved, Standard Pattern	5¾ in 146 mm
04-3318	Curved, Standard Pattern	7 in 178 mm
04-3320	Curved, Standard Pattern	10 in 203 mm



54-5573

### Metzenbaum "Baby" Ceramic Coated Scissors

Micro-Serrations on One Blade, Curved

CODE	DESCRIPTION	LENGTH
224.33.61	Razor Edge, Tungsten Carbide Cutting Edges, Black Ceramic Coating	4½ in 114 mm
214.33.11	Delicate, Black Handle with Gold Screw	4½ in 114 mm



214.33.11

## Scissors (Dissecting)

### Metzenbaum "Slim" Micro-Serrations Razor Edge Scissors

Slender Pattern, One Blade with Micro-Serrations, Black Handle with Gold Screw

CODE	DESCRIPTION	LENGTH
214.34.14	Straight	5½ in 140 mm
214.35.14	Curved	5¾ in 146 mm
214.35.18	Curved	7 in 176 mm
214.35.23	Curved	9 in 229 mm



214.35.18

### Metzenbaum "Baby" Serrated Scissors

One Blade Serrated

CODE	DESCRIPTION	LENGTH
85-3005	Curved	4½ in 114 mm



### Metzenbaum Classic Plus® Dissecting Scissors

Stellite Edge Inserts

CODE	DESCRIPTION	LENGTH
36-5010	Straight	5¾ in 146 mm
36-5011	Straight	7 in 178 mm
36-5015	Curved	5¾ in 146 mm
36-5016	Curved	7 in 178 mm
36-5017	Curved	9 in 229 mm



36-5010

## Scissors (Dissecting)

### Metzenbaum Classic Plus® Dissecting Scissors

Delicate Stellite Edge Inserts

CODE	DESCRIPTION	LENGTH
36-5020	Straight, Sharp Tips	5¾ in 146 mm
36-5022	Straight, Sharp Tips	7 in 178 mm
36-5025	Straight, Blunt Tips	9 in 229 mm
36-5030	Curved, Sharp Tips	5¾ in 146 mm
36-5031	Curved, Blunt Tips	5¾ in 146 mm
36-5032	Curved, Sharp Tips	7 in 178 mm
36-5033	Curved, Blunt Tips	7 in 178 mm
36-5034	Curved, Sharp Tips	9 in 229 mm
36-5035	Curved, Blunt Tips	9 in 229 mm



36-5020

### Metzenbaum Dissecting Scissors

Regular Tips, Tungsten Carbide Cutting Edges

CODE	DESCRIPTION	LENGTH
32-720	Straight	5¾ in 146 mm
32-760	Straight	7 in 178 mm
32-795	Straight	9 in 229 mm
32-710	Curved	5¾ in 146 mm
32-750	Curved	7 in 178 mm
32-790	Curved	9 in 229 mm
32-793	Curved	10 in 254 mm
32-750L	Curved, Left Handed	7 in 178 mm
32-790L	Curved, Left Handed	9 in 229 mm



32-790

### Metzenbaum Dissecting Scissors, Curved

Tungsten Carbide Cutting Edges

CODE	DESCRIPTION	LENGTH
32-678	One Blade Serrated, Delicate Tips	5¾ in 146 mm
32-651	One Blade Serrated, Delicate Tips	7⅙ in 179 mm
32-681	One Blade Serrated, Delicate Tips	9 in 229 mm
32-679	One Blade Serrated, Regular Tips	5¾ in 146 mm
32-677	One Blade Serrated, Regular Tips	7 in 178 mm
32-699	One Blade Serrated, Regular Tips	9 in 229 mm
32-712	Sharp/Sharp Tips	5¾ in 146 mm
32-752	Sharp/Sharp Tips	7 in 178 mm
32-711	Delicate Tips, Left Handed	5¾ in 146 mm
32-751	Delicate Tips	7 in 178 mm
32-791	Delicate Tips	9 in 229 mm



32-677

## Scissors (Dissecting)

### Metzenbaum Dissecting Scissors

Rounded Blades

CODE	DESCRIPTION	LENGTH	
54-1026	Straight	7 in	178 mm
54-1021	Curved	5 $\frac{3}{4}$ in	146 mm
54-1023	Curved	5 in	127 mm
54-1027	Curved	7 in	178 mm
54-1030	Curved	8 in	203 mm
54-1034	Curved	9 in	229 mm
54-1037	Curved	10 in	254 mm



54-1026

### Metzenbaum Scissors

CODE	DESCRIPTION	LENGTH	
32-3594	Curved	12 $\frac{1}{4}$ in	311 mm
32-3595	Curved	13 $\frac{7}{8}$ in	355 mm
32-3596	Curved, Micro-Serrations	13 $\frac{7}{8}$ in	355 mm



32-3594

### Metzenbaum Scissors

Delicate Pattern, Rounded Blades

CODE	DESCRIPTION	LENGTH	
04-3418	Straight	7 in	178 mm
04-3423	Straight	9 in	229 mm
04-3518	Curved	7 $\frac{1}{4}$ in	184 mm
04-3520	Curved	8 in	203 mm
04-3523	Curved	9 in	229 mm



04-3418

## Scissors (Dissecting)

### Metzenbaum Serrated Scissors

One Blade Serrated

CODE	DESCRIPTION	LENGTH	
85-2057	Curved	5 <sup>3</sup> / <sub>4</sub> in	146 mm
85-2062	Curved	8 in	203 mm
85-2060	Curved	9 in	229 mm



85-2060

### Metzenbaum Serrated Scissors

Delicate, One Blade Serrated

CODE	DESCRIPTION	LENGTH	
85-2067	Straight	7 <sup>1</sup> / <sub>8</sub> in	181 mm
85-2070	Curved	5 <sup>3</sup> / <sub>4</sub> in	146 mm
85-2071	Curved	9 in	229 mm



85-2071

### Metzenbaum Serrated Scissors

One Blade Serrated, with Black Handles

CODE	DESCRIPTION	LENGTH	
86-3214	Straight	5 <sup>3</sup> / <sub>4</sub> in	146 mm
86-3223	Straight	9 in	229 mm
86-3318	Curved	7 in	178 mm
86-3323	Curved	9 in	229 mm



86-3214

### Metzenbaum Serrated Scissors

One Blade Serrated with Black Handles

CODE	DESCRIPTION	LENGTH	
86-3218	Straight	7 in	178 mm
86-3211	Curved	4 <sup>1</sup> / <sub>2</sub> in	114 mm
86-3314	Curved	5 <sup>3</sup> / <sub>4</sub> in	146 mm
86-3320	Curved	8 in	203 mm
86-3514	Curved, Slim Pattern	5 <sup>3</sup> / <sub>4</sub> in	146 mm
86-3518	Curved, Slim Pattern	8 in	203 mm



86-3211

## Scissors (Dissecting)

### Metzenbaum Slim Ceramic Coated Scissors

Razor Edge with Micro-Serrations On One Blade, Tungsten Carbide Cutting Edges, Black Ceramic Coating

CODE	DESCRIPTION	LENGTH	
224.35.64	Curved	5 <sup>3</sup> / <sub>4</sub> in	146 mm
224.35.68	Curved	7 in	178 mm
224.35.73	Curved	9 in	229 mm



224.35.68

### Metzenbaum Micro-Serrated Razor Edge Scissors

Razor Edge Micro-Serration Blades, Black Handle

CODE	DESCRIPTION	LENGTH	
80-3305	Straight	4 <sup>1</sup> / <sub>2</sub> in	114 mm
80-3514	Curved, Delicate Pattern	5 <sup>3</sup> / <sub>4</sub> in	146 mm
80-3518	Curved, Delicate Pattern	7 in	178 mm
80-3520	Curved, Delicate Pattern	8 in	203 mm
80-3523	Curved, Delicate Pattern	9 in	229 mm
80-3306	Curved	4 <sup>1</sup> / <sub>2</sub> in	114 mm
80-3314	Curved	5 <sup>3</sup> / <sub>4</sub> in	146 mm
80-3318	Curved	7 <sup>1</sup> / <sub>8</sub> in	181 mm
80-3320	Curved	8 in	203 mm
80-3323	Curved	9 in	229 mm



80-3306



80-3318

### Metzenbaum Micro-Serrated Razor Edge Scissors

Black Handle with Gold Screw

CODE	DESCRIPTION	LENGTH	
214.32.14	Straight	5 <sup>1</sup> / <sub>2</sub> in	140 mm
214.32.18	Straight	7 <sup>1</sup> / <sub>8</sub> in	181 mm
214.33.14	Curved	5 <sup>1</sup> / <sub>2</sub> in	140 mm
214.33.18	Curved	7 <sup>1</sup> / <sub>8</sub> in	181 mm
214.33.20	Curved	8 in	203 mm



214.32.14

## Scissors (Dissecting)

### Metzenbaum Micro-Serrated Scissors

One Blade Serrated, Gold Screw

CODE	DESCRIPTION	LENGTH
204.33.11	Curved, Baby Pattern	4½ in 114 mm



### Metzenbaum Micro-Serrated Slim Scissors

One Blade Serrated, Gold Screw, Slim Pattern

CODE	DESCRIPTION	LENGTH
204.35.18	Curved	7⅛ in 181 mm
204.35.23	Curved	9 in 229 mm

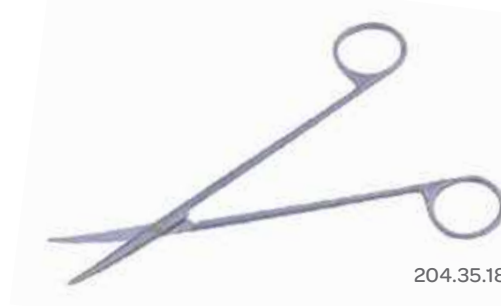

204.35.18

### Micro Dissecting Scissors

Curved, Flat Handle 8.0 mm Diameter

CODE	DESCRIPTION	LENGTH
78-0330	20 mm Blades	4½ in 114 mm
78-0345	Micro Pattern, 19 mm Serrated Blade	5¾ in 146 mm



78-0345

### Micro Dissecting Scissors

Flat Handle 8.0 mm Diameter

CODE	DESCRIPTION	LENGTH
78-0355	Straight, 15 mm Blades	5½ in 140 mm
78-0350	Curved, 10 mm Serrated Blades	5½ in 140 mm



78-0355



## Scissors (Dissecting)

### Micro Scissors

Flat Handle 8.0 mm Diameter, 14.0 mm Blades

CODE	DESCRIPTION	LENGTH
78-0365	Straight	6 in 152 mm

### Mixer Operating Scissors

Blunt

CODE	DESCRIPTION	LENGTH
54-1010	Straight	6 in 152 mm



### Nelson Classic Plus® Scissors

Stellite Edge Inserts

CODE	DESCRIPTION	LENGTH
36-5070	Curved, Regular Tips	11 in 279 mm
36-5071	Curved, Delicate Tips	11 in 279 mm



36-5070

### Nelson Metzenbaum Dissecting Scissors

Standard Pattern, Rounded Blades

CODE	DESCRIPTION	LENGTH
04-3223	Straight	9 in 229 mm
04-3226	Straight	10 ¼ in 260 mm
04-3230	Straight	11 ¾ in 398 mm
04-3232	Straight	14 in 356 mm
04-3245	Straight	18 in 458 mm
04-3323	Curved	9 in 229 mm
04-3326	Curved	10 ¼ in 260 mm
04-3330	Curved	11 ¾ in 298 mm
04-3338	Curved	12 in 305 mm
04-3332	Curved	14 in 356 mm
04-3340	Curved	16 in 406 mm
04-3345	Curved	18 in 458 mm



04-3223

## Scissors (Dissecting)

### Nelson Metzenbaum Scissors

Tungsten Carbide Cutting Edges

CODE	DESCRIPTION	LENGTH	
32-794	Straight, Regular Tips	12 in	305 mm
32-798	Straight, Regular Tips	14 in	356 mm
32-799	Curved, Regular Tips	14 in	356 mm
32-880	Curved, Regular Tips	11 in	279 mm
32-882	Curved, Regular Tips	12 in	305 mm
32-899	Curved, Regular Tips	12 in	305 mm
32-999	Curved, Regular Tips	14 in	356 mm



### Nelson Metzenbaum Micro-Serrated Razor Edge Scissors

One Blade with Micro-Serrations, Black Handle with Gold Screw

CODE	DESCRIPTION	LENGTH	
214.33.23	Curved	9 in	229 mm
214.33.30	Curved	11 in	279 mm
214.33.26	Curved	11¼ in	286 mm



### Nelson Metzenbaum Micro-Serrated Scissors

One Blade Serrated, Gold Screw

CODE	DESCRIPTION	LENGTH	
204.32.30	Straight	11¾ in	298 mm



### Nelson Scissors

Rounded Blades

CODE	DESCRIPTION	LENGTH	
54-8025	Straight	9 in	229 mm



## Scissors (Dissecting)

### Ragnell Kilner Micro-Serrated Razor Edge Scissors

One Blade with Micro-Serrations, Black Handle with Gold Screw

CODE	DESCRIPTION	LENGTH
214.13.15	Curved	6 in 152 mm



### Razor Edge Joseph Scissors

Micro-Serrated Blades, Black Handle

CODE	DESCRIPTION	LENGTH
80-5115	Curved	5 5/8 in 143 mm

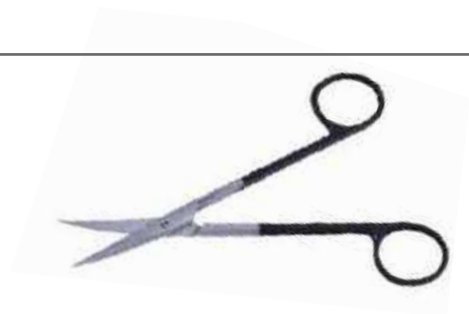

### Razor Freeman-Gorney Scissors

Razor Edge Micro-Serrated Blades, Black Handle

CODE	DESCRIPTION	LENGTH
80-6066	Curved	7 1/4 in 184 mm



### Reynolds Dissecting Scissors

Delicate Pattern, Tenotomy Tips

CODE	DESCRIPTION	LENGTH
04-6712	Curved	5 in 127 mm
04-6714	Curved	5 5/8 in 143 mm
04-6716	Curved	6 1/4 in 159 mm
04-6718	Curved	7 1/8 in 181 mm
04-6718L	Curved, Left Handed Pattern	7 1/8 in 181 mm



### Micro-Serrated Dissecting Scissors

One Blade Serrated, Gold Screw

CODE	DESCRIPTION	LENGTH
202.41.12	Curved	4 3/4 in 121 mm



## Scissors (Dissecting)

### Vannas Dissecting Scissors

13 mm Blades, Round Handle 8.0 mm Diameter

CODE	DESCRIPTION	LENGTH	
78-0320	Straight	6 in	152 mm
78-0310	Curved	6 in	152 mm

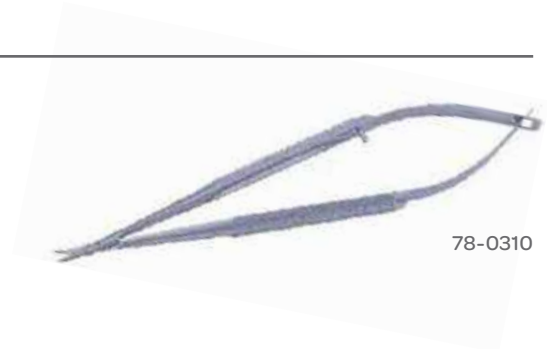

78-0310

## Scissors (Dural)

### Frazier Dural Scissors

CODE	DESCRIPTION	LENGTH	
54-1055	Angled	6 <sup>3</sup> / <sub>4</sub> in	171 mm



## Scissors (Enucleation)

### Enucleation Scissors

Heavy Pattern

CODE	DESCRIPTION	LENGTH	
60-1750	Medium Curve	5 <sup>1</sup> / <sub>2</sub> in	140 mm
60-1751	Strong Curve	5 <sup>1</sup> / <sub>2</sub> in	140 mm
60-1749	Slight Curve	5 <sup>1</sup> / <sub>2</sub> in	140 mm



60-1750

## Scissors (Episiotomy)

### Braun Episiotomy Scissors

One Guarded Blade

CODE	DESCRIPTION	LENGTH
54-5579	Angled	8½ in 216 mm



### Roberts Episiotomy Scissors

CODE	DESCRIPTION	LENGTH
54-5526	Serrated Blade	5½ in 140 mm



## Scissors

### Scissors

Straight, Serrated Jaws, Titanium

CODE	DESCRIPTION	LENGTH
80-6008	Fine Tip	6 in 152 mm
80-6009	Regular Tip	6 in 152 mm



## Scissors (Eye)

### Eye Scissors

Standard Pattern

CODE	DESCRIPTION	LENGTH
60-1847	Straight	4½ in 105 mm
60-1848	Curved	4½ in 105 mm



## Scissors (Ganglion)

### Adson Ganglion Scissors

Sharp

CODE	DESCRIPTION	LENGTH
54-1005	Straight	6 ¼ in 159 mm
54-1006	Curved	6 ¼ in 159 mm

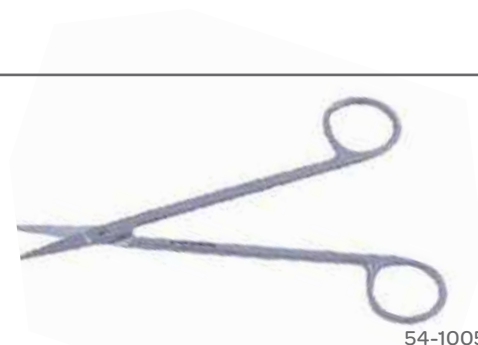

54-1005

### Adson Kelly Ganglion Scissors

Sharp Outer Edges

CODE	DESCRIPTION	LENGTH
04-5516	Curved	6 ¼ in 159 mm



## Scissors (Gynecology)

### Zep Scissors

Tungsten Carbide Cutting Edges

CODE	DESCRIPTION	LENGTH
32-889	Curved	9 in 229 mm
32-892	Curved	10 ½ in 267 mm
32-895	Curved	12 in 305 mm
32-890	Full Curve	9 in 229 mm
32-893	Full Curve	10 ½ in 267 mm
32-896	Full Curve	12 in 305 mm
32-898	Full Curve	14 in 356 mm
32-888	Slight Curve	9 in 229 mm
32-891	Slight Curve	10 ½ in 267 mm
32-894	Slight Curve	12 in 305 mm



32-898

## Scissors (Iris)

### Iris Scissors

CODE	DESCRIPTION	LENGTH
32-675	Curved, One Blade Serrated, Sharp Tips, Tungsten Carbide Cutting Edges	4 ½ in 114 mm
32-676	Straight, One Blade Serrated, Sharp Tips, Tungsten Carbide Cutting Edges	4 ½ in 114 mm
32-705	Curved, Sharp Tips, Tungsten Carbide Cutting Edges	4 ½ in 114 mm
32-706	Straight, Sharp Tips, Tungsten Carbide Cutting Edges	4 ½ in 114 mm
60-1829	Straight, Standard Pattern	
60-1830	Curved, Standard Pattern	4 in 102 mm
02-2009	Straight, Standard Pattern	3 ½ in 89 mm
02-2010	Straight, Standard Pattern	4 ⅛ in 105 mm
02-2011	Straight, Standard Pattern	4 ½ in 114 mm
02-2012	Straight, Standard Pattern	5 in 127 mm
02-2109	Curved, Standard Pattern	3 ½ in 89 mm
02-2110	Curved, Standard Pattern	4 ⅛ in 105 mm
02-2111	Curved, Standard Pattern	4 ½ in 114 mm
02-2112	Curved, Standard Pattern	5 in 127 mm
60-1823	Straight, Short Blades, Sharp Tips, Flat Shanks, Large Ribbon Ring Handles	4 in 102 mm
60-1824	Curved, Short Blades, Sharp Tips, Flat Shanks, Large Ribbon Ring Handles	4 in 102 mm
60-1826	Curved, Flat Shanks, Large Ribbon Ring Handles	4 ⅛ in 105 mm
60-1827	Straight, Delicate Blades, Sharp/Sharp, Large Ring Handles	4 in 102 mm
60-1828	Curved, Delicate Blades, Sharp/Sharp, Large Ring Handles	4 in 102 mm
60-1843	Straight, Blunt, Flat Shanks, Large Ribbon Ring Handles	4 in 102 mm
60-1845	Straight, Blunt, Flat Shanks, Large Ribbon Ring Handles	4 in 102 mm
60-1844	Curved, Blunt, Flat Shanks, Large Ribbon Ring Handles	4 in 102 mm
60-1846	Curved, Blunt, Flat Shanks, Large Ribbon Ring Handles	4 in 102 mm



32-705

## Scissors (Iris)

### Iris Classic® Scissors

Sharp/Sharp

CODE	DESCRIPTION	LENGTH
34-6500	Straight	4 <sup>3</sup> / <sub>8</sub> in 111 mm
34-6503	Curved	4 <sup>3</sup> / <sub>8</sub> in 111 mm



34-6500

### Iris Classic Plus® Scissors

Sharp/Sharp, Tungsten Carbide Cutting Edges

CODE	DESCRIPTION	LENGTH
36-5000	Straight	4 <sup>1</sup> / <sub>2</sub> in 114 mm
36-5001	Curved	4 <sup>1</sup> / <sub>2</sub> in 114 mm



36-5000

### Iris Ceramic Coated Scissors

One Blade Serrated, Tungsten Carbide Cutting Edges, Black Ceramic Coating

CODE	DESCRIPTION	LENGTH
222.21.61	Curved	4 <sup>1</sup> / <sub>2</sub> in 114 mm

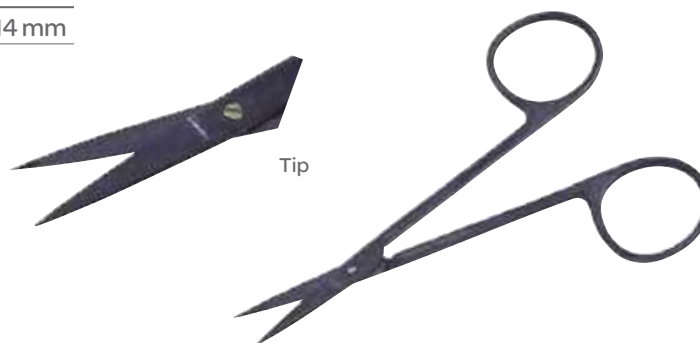

Tip



## Scissors (Iris)

### Iris Serrated Scissors

One Blade Serrated

CODE	DESCRIPTION	LENGTH
85-2010	Straight	4 <sup>1</sup> / <sub>8</sub> in 105 mm
85-2013	Straight	4 <sup>1</sup> / <sub>2</sub> in 114 mm
85-2015	Curved	4 <sup>1</sup> / <sub>2</sub> in 114 mm
86-2011	Straight with Black Handles	4 <sup>1</sup> / <sub>2</sub> in 114 mm
86-2111	Curved with Black Handles	4 <sup>1</sup> / <sub>2</sub> in 114 mm



85-2010

### Iris Micro-Serrated Razor Edge Scissors

One Blade, Black Handle with Gold Screw

CODE	DESCRIPTION	LENGTH
212.20.11	Straight	4 <sup>1</sup> / <sub>2</sub> in 114 mm



### Iris Micro-Serrated Scissors

One Blade Serrated, Gold Screw

CODE	DESCRIPTION	LENGTH
202.20.10	Straight	4 <sup>1</sup> / <sub>2</sub> in 114 mm
202.21.10	Curved	4 <sup>1</sup> / <sub>8</sub> in 105 mm



202.20.10

### Dissecting Scissors

Fine Pattern

CODE	DESCRIPTION	LENGTH
02-2042	Straight, Sharp/Sharp	4 <sup>3</sup> / <sub>4</sub> in 121 mm
02-2043	Straight, Blunt/Blunt	4 <sup>3</sup> / <sub>4</sub> in 121 mm
02-2142	Curved, Sharp/Sharp	4 <sup>3</sup> / <sub>4</sub> in 121 mm



02-2042

## Scissors (Iris)

### Knapp Scissors

Rounded Blades, Blunt Tips

CODE	DESCRIPTION	LENGTH
60-1865	Straight, Standard Pattern	4 1/8 in 105 mm
60-1866	Curved, Standard Pattern	4 1/8 in 105 mm



60-1865

### Knapp Iris Scissors

CODE	DESCRIPTION	LENGTH
54-6524	Straight, Sharp/Blunt	4 in 102 mm
54-6525	Curved, Sharp/Blunt	4 in 102 mm
54-6526	Straight, Blunt/Blunt	4 in 102 mm
54-6527	Curved, Blunt/Blunt	4 in 102 mm



54-6524

## Scissors (Micro)

### Double Action Micro Scissors

CODE	DESCRIPTION	LENGTH
55-8705	Curved Blades	7 1/4 in 184 mm



### Jabaley Micro-Serrated Razor Edge Scissors

Razor Edge, Micro-Serrations, Black Handle

CODE	DESCRIPTION	LENGTH
80-2095	Straight	5 in 127 mm
80-2096	Curved	5 in 127 mm



80-2095

## Scissors (Micro)

### Jacobson Micro Scissors

Flat Handle

CODE	DESCRIPTION	LENGTH
55-8088	Angled, Sharp Tips	6 <sup>3</sup> / <sub>4</sub> in 171 mm
55-8089	Angled, Dull Tips	6 <sup>3</sup> / <sub>4</sub> in 171 mm
55-8710	25°, Angled On Flat	7 in 178 mm
55-8711	45°, Angled On Flat	7 in 178 mm
55-8712	60°, Angled On Flat	7 in 178 mm



55-8710

### Micro Adventitia Scissors

15 mm Blades, Round Handle

CODE	DESCRIPTION	HANDLE DIAMETER	LENGTH
78-0510	Straight	8.0 mm	7 in 178 mm
78-0515	Curved	10 mm	7 in 178 mm



78-0510

### Micro Dissecting Scissors

Vannas Type Cutting Blades

CODE	DESCRIPTION	BLADES	HANDLE	LENGTH
05-1230	Straight	5.0 mm	Flat	5 in 127 mm
05-1220	Straight	10 mm	Flat	5 in 127 mm
05-1221	Curved	10 mm	Flat	5 in 127 mm
05-1231	Curved	5.0 mm	Wide	5 in 127 mm



05-1230

### Micro Scissors

CODE	DESCRIPTION	LENGTH
80-2005	Straight Tip	5 <sup>1</sup> / <sub>2</sub> in 140 mm
80-2015	Straight Tip	7 in 178 mm
80-2006	Curved Tip	5 <sup>1</sup> / <sub>2</sub> in 140 mm
80-2016	Curved Tip	7 in 178 mm



80-2006

## Scissors (Micro)

### Castroviejo Micro Scissors

Angled, Sharp Delicate Blades, Round Handle

CODE	DESCRIPTION	LENGTH
55-8049	25°	4 ½ in 114 mm
55-8050	45°	4 ½ in 114 mm
55-8051	60°	4 ½ in 114 mm
55-8053	125°	4 ½ in 114 mm



## Scissors (Micro)

### Micro Dissecting Scissors

CODE	DESCRIPTION	LENGTH
78-0306	Curved Blade, 8.0 mm	4 ¾ in 121 mm



## Scissors (Moleskin)

### Moleskin Scissors

Sharp/Blunt, One Blade Serrated

CODE	DESCRIPTION	LENGTH
04-1350	Straight	7 ½ in 191 mm



# Scissors (Neuro)

## Verity™ Neurosurgical Scissors

CODE	DESCRIPTION	LENGTH
54-1015	Curved, Semi-Sharp Blades	7 in 178 mm



## Verity™ Scissors

Titanium

CODE	DESCRIPTION	WORKING DISTANCE	LENGTH
80-1520	Straight, Fine		6 3/4 in 171 mm
80-1521	Straight, Curved Fine		6 3/4 in 171 mm
80-1522	Straight, Bayonet, Regular	3 3/4 in 95 mm	9 1/2 in 241 mm
80-1523	Straight, Bayonet, Fine	3 3/4 in 95 mm	9 1/2 in 241 mm
80-1524	Curved Up, Bayonet, Regular	3 3/4 in 95 mm	9 1/2 in 241 mm
80-1525	Curved Up, Bayonet, Fine	3 3/4 in 95 mm	9 1/2 in 241 mm
80-1526	Curved Down, Bayonet, Regular	3 3/4 in 95 mm	9 1/2 in 241 mm

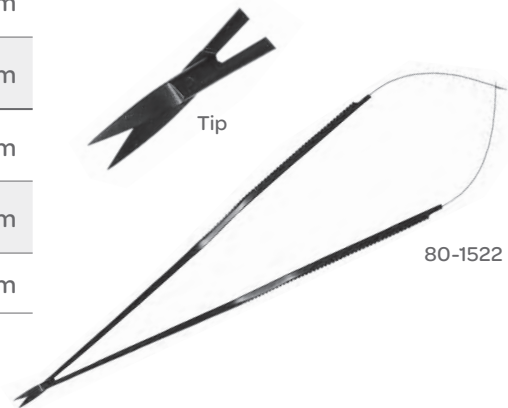

## Verity™ Scissors

Titanium

CODE	TIP	WORKING DISTANCE	LENGTH
80-1720	Straight		7 in 178 mm
80-1722	Straight, Bayonet	3 1/2 in 89 mm	8 1/2 in 216 mm
80-1744	Straight, Bayonet	3 1/2 in 89 mm	9 1/2 in 241 mm
80-1721	Curved		7 in 178 mm
80-1723	Curved, Bayonet	3 1/2 in 89 mm	8 1/2 in 216 mm
80-1745	Curved Up, Bayonet	3 1/2 in 89 mm	9 1/2 in 241 mm

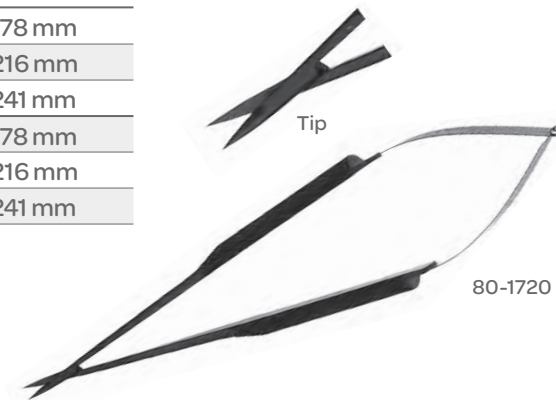

## Scissors (Neuro)

### Spetzler Neuro-Vascular Scissors

4.0 mm Tip, Titanium, Bayonet

CODE	DESCRIPTION	WORKING DISTANCE	LENGTH
80-1907	Straight Tip	4 in 102 mm	9½ in 241 mm
80-1908	Curved 30° Tip	4 in 102 mm	9½ in 241 mm



80-1907

### Strully Neurological Scissors

CODE	DESCRIPTION	LENGTH
54-1046	Curved, Dissecting Tip	8 in 203 mm



### Taylor Dural Scissors

CODE	DESCRIPTION	LENGTH
54-1050	Angled	5¾ in 146 mm



## Scissors (Operating)

### Deaver Operating Scissors

CODE	DESCRIPTION	LENGTH
54-4066	Straight, Sharp/Blunt	5½ in 140 mm



## Scissors (Operating)

### Operating Classic Plus® Scissors

Stellite Edge Inserts

CODE	DESCRIPTION	LENGTH
36-5040	Straight, Sharp/Blunt	5½ in 140 mm



### Operating Scissors

Beveled Blades

CODE	DESCRIPTION	LENGTH
03-0211	Straight, Blunt/Blunt	4½ in 114 mm
03-0214	Straight, Blunt/Blunt	5½ in 140 mm
03-0215	Straight, Blunt/Blunt	6 in 152 mm
03-0283	Straight, Blunt/Blunt, Slender Pattern	5 in 127 mm
03-0216	Straight, Blunt/Blunt, Slender Pattern	6½ in 165 mm
03-0411	Straight, Sharp/Sharp Tips	4¾ in 121 mm
03-0413	Straight, Sharp/Sharp Tips	5 in 127 mm
03-0414	Straight, Sharp/Sharp Tips	5¾ in 146 mm
03-0415	Straight, Sharp/Sharp Tips	6 in 152 mm
03-0311	Curved, Blunt/Blunt	4½ in 114 mm
03-0314	Curved, Blunt/Blunt	5¾ in 146 mm
03-0383	Curved, Blunt/Blunt, Slender Pattern	5 in 127 mm
03-0511	Curved, Sharp/Sharp Tips	4½ in 114 mm
03-0513	Curved, Sharp/Sharp Tips	5 in 127 mm
03-0514	Curved, Sharp/Sharp Tips	5¾ in 146 mm
03-0515	Curved, Sharp/Sharp Tips	6½ in 156 mm



03-0211

## Scissors (Operating)

### Operating Scissors

Sharp/Blunt Tips, Beveled Blades

CODE	DESCRIPTION	LENGTH
03-0611	Straight	4 <sup>3</sup> / <sub>4</sub> in 121 mm
03-0613	Straight	5 in 127 mm
03-0614	Straight	5 <sup>3</sup> / <sub>4</sub> in 146 mm
03-0615	Straight	6 in 152 mm
03-0618	Straight	7 <sup>1</sup> / <sub>4</sub> in 184 mm



03-0611

### Operating Scissors

Tungsten Carbide Cutting Edges

CODE	DESCRIPTION	LENGTH
32-600	Straight, Sharp/Blunt	5 <sup>1</sup> / <sub>2</sub> in 140 mm
32-640	Straight, Blunt/Blunt	5 <sup>1</sup> / <sub>2</sub> in 140 mm
32-630	Curved, Sharp/Sharp	5 <sup>1</sup> / <sub>2</sub> in 140 mm



32-600

### Operating Scissors

Delicate Pattern

CODE	DESCRIPTION	LENGTH
54-4300	Straight, Sharp/Blunt	5 in 127 mm
54-4301	Straight, Sharp/Sharp	5 in 127 mm
54-4306	Straight, Sharp/Blunt	5 <sup>1</sup> / <sub>2</sub> in 140 mm



54-4300

### Operating Scissors

CODE	DESCRIPTION	LENGTH
54-4026	Straight, Sharp/Blunt	5 in 127 mm
54-4027	Straight, Sharp/Sharp	5 in 127 mm
54-4028	Straight, Blunt/Blunt	5 <sup>1</sup> / <sub>2</sub> in 140 mm



54-4027



## Scissors (Operating)

### Operating Scissors

CODE	DESCRIPTION	LENGTH
54-4034	Straight, Blunt/Blunt	6½ in 165 mm
54-4029	Straight, Sharp/Blunt	5½ in 140 mm
54-4032	Straight, Sharp/Blunt	6 in 152 mm
54-4035	Straight, Sharp/Blunt	6½ in 165 mm
54-4030	Straight, Sharp/Sharp	5½ in 140 mm



54-4029

### Razor Edge Operating Scissors

One Blade Serrated, Gold Screws

CODE	DESCRIPTION	LENGTH
203.06.14	Straight, Sharp/Blunt	5¾ in 146 mm



### Sims Operating Scissors

Sharp/Blunt, Beveled Blades

CODE	DESCRIPTION	LENGTH
03-3420	Straight	8 in 203 mm



## Scissors (Stitch)

### Gradle Stitch Scissors

Sharp Tips, Flat Shanks, Large Ribbon Ring Handles, Curved

CODE	DESCRIPTION	LENGTH
60-1812	Extra Delicate Blades	3¾ in 95 mm
60-1813	Delicate Blades	3¾ in 95 mm

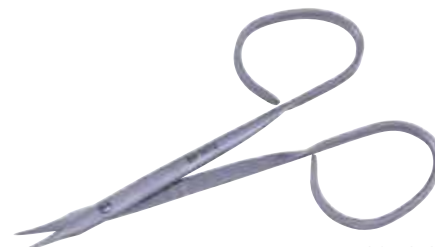

60-1813

## Scissors (Stitch)

### Littauer Stitch Scissors

CODE	DESCRIPTION	LENGTH
54-4017	Stitch Scissors	5½ in 140 mm



### Spencer Stitch Scissors

CODE	DESCRIPTION	LENGTH
54-6624	Stitch Scissors	3½ in 89 mm
14-0609	Stitch Scissors, Delicate	3½ in 89 mm
54-4205	Stitch Scissors	4½ in 114 mm
14-0610	Stitch Scissors, Regular	4½ in 114 mm
14-0612	Stitch Scissors, Slender	4½ in 114 mm



54-6624

### Wescott Stitch Scissors

CODE	DESCRIPTION	LENGTH
54-6630	Sharp/Sharp	4¼ in 108 mm



## Scissors (Suture)

### New Suture Scissors

CODE	DESCRIPTION	LENGTH
54-2550	Angled On Side	5½ in 140 mm



## Scissors (Suture Wire)

### Suture Wire Scissors

One Blade Serrated, Tungsten Carbide Cutting Edges

CODE	DESCRIPTION	LENGTH
32-900	Angled	5 in 127 mm



## Scissors (Tenotomy)

### Metzenbaum Razor Edge Tenotomy Scissors

Tenotomy, Razor Edge Blades, Black Handle

CODE	DESCRIPTION	LENGTH
80-3620	Straight	9 in 229 mm

### Potts Razor Edge Scissors

One Blade with Micro Serrations, Black Handle with Gold Screw

CODE	DESCRIPTION	LENGTH
214.56.77	Straight	8 in 203 mm
214.55.77	Curved	8 in 203 mm



214.55.77

### Reynolds Scissors

Tenotomy Tips, Curved

CODE	DESCRIPTION	LENGTH
55-1012	Serrated Edge	6 in 152 mm
55-1014	Serrated Edge	7 in 178 mm
55-1013	Plain Edge	7 in 178 mm



55-1012

## Scissors (Tenotomy)

### Steven Tenotomy Razor Edge Scissors

One Blade with Micro Serrations, Black Handle with Gold Screw

CODE	DESCRIPTION	LENGTH
212.50.12	Straight	4½ in 114 mm
212.50.13	Curved	4½ in 114 mm



212.50.13

### Stevens Tenotomy Scissors

Tungsten Carbide Cutting Edges

CODE	DESCRIPTION	LENGTH
32-708	Straight	4½ in 114 mm
32-709	Curved	4½ in 114 mm



32-708

### Stevens Tenotomy Razor Edge Scissors

Razor Edge Blades, Black Handle

CODE	DESCRIPTION	LENGTH
80-5012	Straight	5 in 127 mm
80-5025	Straight	7 in 178 mm
80-5009	Curved	4½ in 114 mm
80-5013	Curved	5 in 127 mm
80-5125	Curved	7 in 178 mm



80-5012

## Scissors (Tenotomy)

### Stevens Serrated Tenotomy Scissors

Razor Edge Blades, Black Handle , One Blade Serrated

CODE	DESCRIPTION	LENGTH
85-2001	Straight	4 ½ in 114 mm
86-5012	Straight	4 ½ in 114 mm
85-2002	Curved	4 ½ in 114 mm
85-2601	Curved	4 ½ in 114 mm
86-5013	Curved	4 ½ in 114 mm
86-5111	Curved	5 ½ in 140 mm
86-5125	Curved	7 in 178 mm



86-5012

### Stevens Tenotomy Ceramic Coated Scissors

One Blade with Micro Serrations, Tungsten Carbide Cutting Edges, Black Ceramic Coating

CODE	DESCRIPTION	LENGTH
222.50.62	Straight, Delicate	4 ½ in 105 mm
222.50.63	Curved, Delicate	4 ½ in 105 mm
224.67.63	Curved, Delicate	5 ½ in 130 mm



222.50.62

### Stevens Tenotomy Scissors

CODE	DESCRIPTION	LENGTH
54-6520	Straight	4 ½ in 105 mm
54-6522	Straight	4 5/8 in 117 mm
54-6521	Curved	4 ½ in 105 mm
54-6523	Curved	4 5/8 in 117 mm



54-6520

## Scissors (Tenotomy)

### Strabismus Scissors

Blunt Tips, Tungsten Carbide Cutting Edges

CODE	DESCRIPTION	LENGTH
32-701	Straight	4½ in 114 mm
32-671	Straight, One Blade Serrated	4½ in 114 mm
32-700	Curved	4½ in 114 mm
32-670	Curved, One Blade Serrated	4½ in 114 mm



32-670

### Strabismus Classic Plus® Scissors

Blunt/Blunt, Stellite Edge Inserts

CODE	DESCRIPTION	LENGTH
36-5005	Straight	4½ in 114 mm



### Strabismus Scissors

Blunt/Blunt

CODE	DESCRIPTION	LENGTH
54-6515	Straight	4½ in 114 mm
34-6517	Curved	4½ in 114 mm
54-6517	Curved	4½ in 114 mm



34-6517

## Scissors (Tenotomy)

### Razor Edge Serrated Stevens Tenotomy Scissors

One Blade Serrated, Gold Screw

CODE	DESCRIPTION	LENGTH
202.50.12	Straight	4 ½ in 114 mm
202.50.13	Curved	4 ½ in 114 mm
204.67.13	Curved	5 ⅞ in 130 mm



202.50.13

### Stevens Tenotomy Scissors

CODE	DESCRIPTION	LENGTH
02-5002	Straight, Sharp Tips	4 in 102 mm
02-5003	Curved, Sharp Tips	4 in 102 mm



02-5002

### Wescott Tenotomy Scissors

CODE	DESCRIPTION	LENGTH
54-6513	Blunt/Blunt	4 ¼ in 108 mm



## Scissors (Tenotomy)

### Potts Tenotomy Scissors

Tenotomy Tips

CODE	DESCRIPTION	LENGTH
04-5677	Curved	8 in 203 mm



### Stevens Tenotomy Scissors

Blunt Tips

CODE	DESCRIPTION	LENGTH
02-5012	Straight	4 1/8 in 105 mm
02-5110	Straight	5 1/2 in 140 mm
02-5013	Curved	4 1/8 in 105 mm
02-5111	Curved	5 1/2 in 140 mm
02-5123	Curved	6 1/2 in 165 mm
02-5125	Curved	7 in 178 mm

60-1804	Straight, Light Pattern, Flat Shanks, Large Ribbon Ring Handles	4 in 102 mm
60-1807	Curved, Light Pattern, Flat Shanks, Large Ribbon Ring Handles	4 in 102 mm



02-5012



60-1804

## Scissors (Tissue)

### Calcified Tissue Scissors

CODE	DESCRIPTION	LENGTH
54-8024	Curved, Serrated Blades	9 in 229 mm





## Scissors (Tissue & Gum)

### Fox Tissue & Gum Scissors

Tungsten Carbide Cutting Edges

CODE	DESCRIPTION	LENGTH
32-941	Straight	5 $\frac{1}{8}$ in 130 mm
32-940	Curved	5 $\frac{1}{8}$ in 130 mm



32-941

## Scissors (Umbilical)

### American Umbilical Scissors

CODE	DESCRIPTION	LENGTH
54-5545	Umbilical Scissors	4 in 102 mm



### Busch Umbilical Scissors

CODE	DESCRIPTION	LENGTH
54-5578	Curved On Side	6 $\frac{1}{2}$ in 165 mm



## Scissors (Uterine)

### Sims Uterine Scissors

CODE	DESCRIPTION	LENGTH
54-5500	Straight, Blunt/Blunt	8 in 203 mm
54-5503	Curved, Blunt/Blunt	8 in 203 mm



54-5500

## Scissors (Utility)

### Utility Scissors

Blunt, Flat Shanks, Large Ribbon Ring Handles

CODE	DESCRIPTION	LENGTH
60-1853	Lightly Curved	4 in 102 mm

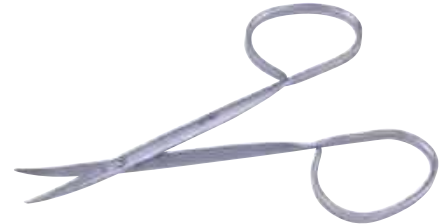

## Scissors (Vascular)

### Cooley "My Scissor" Ceramic Coated Scissors

Razor Edge with Micro Serrations On One Blade, Black Ceramic Coating

CODE	DESCRIPTION	LENGTH
84-1350	Curved	7¼ in 184 mm



### DeBakey-Potts Scissors

Angled, Tungsten Carbide Cutting Edges

CODE	DESCRIPTION	LENGTH
32-172	25°	7 in 178 mm
32-176	45°	9 in 229 mm



32-172

### DeBakey-Metzenbaum Scissors

Tungsten Carbide Edges

CODE	DESCRIPTION	LENGTH
32-3576	Straight	12¼ in 311 mm



## Scissors (Vascular)

### Diethrich Scissors

Angled, One Blade Serrated, Tungsten Carbide Cutting Edges

CODE	DESCRIPTION	LENGTH
32-844	25°	7 in 178 mm
32-845	45°	7 in 178 mm
32-846	60°	7 in 178 mm
32-847	90°	7 in 178 mm
65-848	120°	7 in 178 mm



### Diethrich Vascular Ceramic Coated Scissors

Angled, Razor Edges with Serrations on One Blade, Tungsten Carbide Cutting Edges, Black Ceramic Coating

CODE	DESCRIPTION	LENGTH
225.15.32	25°	7¼ in 184 mm
225.15.34	45°	7⅝ in 181 mm
225.15.36	60°	7 in 178 mm
225.15.39	90°	6¾ in 171 mm



### Diethrich Vascular Ceramic Coated Scissors

Angled, Razor Edges and Micro Serrations, Tungsten Carbide Cutting Edges, Black Ceramic Coating

CODE	DESCRIPTION	LENGTH
225.15.40	125°	7⅝ in 181 mm

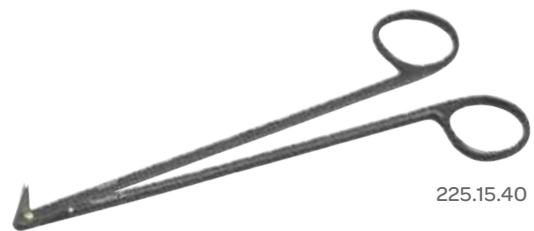

### Litwak Mitral Valve Scissors

One Blade Serrated, Gold Screw

CODE	DESCRIPTION	LENGTH
54-8023	Angled On Side	11 in 279 mm



## Scissors (Vascular)

### Micro Vascular Scissors

Angled, Extra Delicate, Round Handle

CODE	DESCRIPTION	LENGTH
55-8062	120°	6 <sup>3</sup> / <sub>4</sub> in 171 mm
55-8058	25°	7 in 178 mm
55-8059	45°	7 in 178 mm
55-8060	60°	7 in 178 mm
55-8061	90°	7 in 178 mm
55-8091	25°	8 <sup>1</sup> / <sub>4</sub> in 210 mm
55-8092	45°	8 <sup>1</sup> / <sub>4</sub> in 210 mm
55-8094	90°	8 <sup>1</sup> / <sub>4</sub> in 210 mm
55-8095	120°	8 <sup>1</sup> / <sub>4</sub> in 210 mm



### Micro Vascular Scissors

Angled, Delicate Tips, Flat Handle

CODE	DESCRIPTION	LENGTH
55-8160	25°	6 <sup>3</sup> / <sub>4</sub> in 171 mm
55-8165	45°	6 <sup>3</sup> / <sub>4</sub> in 171 mm
55-8170	60°	6 <sup>3</sup> / <sub>4</sub> in 171 mm
55-8175	90°	6 <sup>3</sup> / <sub>4</sub> in 171 mm
55-8178	120°	6 <sup>3</sup> / <sub>4</sub> in 171 mm

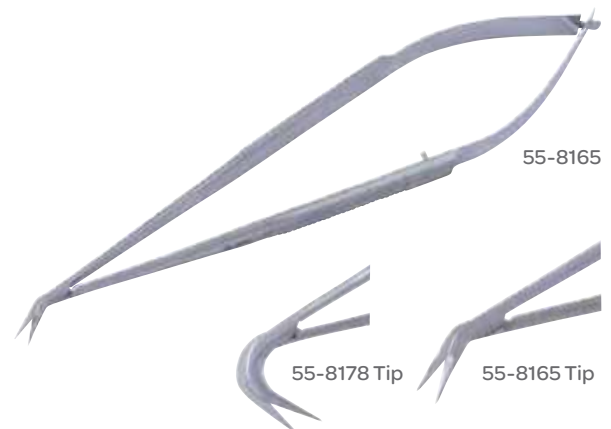

### Potts-Smith Scissors

Angled, Tungsten Carbide Cutting Edges

CODE	DESCRIPTION	LENGTH
32-191	25°	7 <sup>1</sup> / <sub>2</sub> in 191 mm
32-192	45°	7 <sup>1</sup> / <sub>2</sub> in 191 mm
32-193	60°	7 <sup>1</sup> / <sub>2</sub> in 191 mm



## Scissors (Vascular)

### Potts Tenotomy Ceramic Coated Scissors

One Blade with Micro Serrations, Tungsten Carbide Cutting Edges, Black Ceramic Coating

CODE	DESCRIPTION	LENGTH
224.56.77	Curved	8 in 203 mm



### Potts Tenotomy Scissors

CODE	DESCRIPTION	LENGTH
37-4032	Curved	6 in 152 mm



### Potts-Smith Ceramic Coated Scissors

Angled, Razor Edge with Micro Serrations on One Blade, Tungsten Carbide Cutting Edges, Black Ceramic Coating

CODE	DESCRIPTION	LENGTH
225.15.43	25°	7¼ in 184 mm
225.15.44	45°	7¼ in 184 mm
225.15.46	60°	7¼ in 184 mm



### Potts-Smith Razor Edge Serrated Scissors

One Blade Serrated, Gold Screw

CODE	DESCRIPTION	LENGTH
255.15.42	Angled 25°	7½ in 191 mm
255.15.44	Angled 45°	7½ in 191 mm

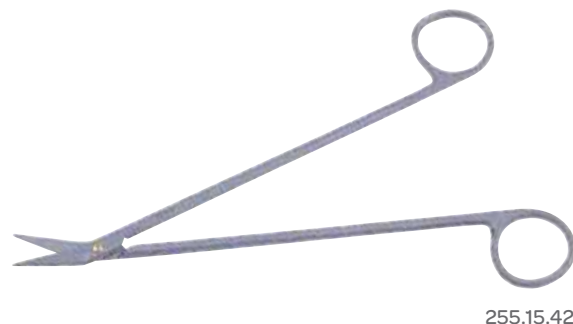

## Scissors (Vascular)

### Micro Vascular Scissors

Titanium, Angled, Extra Delicate, Round Handle

CODE	DESCRIPTION	TIPS	LENGTH
80-1801	Straight		7 in 178 mm
80-1802	Curved		7 in 178 mm
80-1803	Straight	Angled, 60°	7 in 178 mm
80-1804	Right Curved	Angled, 60°	7 in 178 mm
80-1805	Left Curved	Angled, 60°	7 in 178 mm

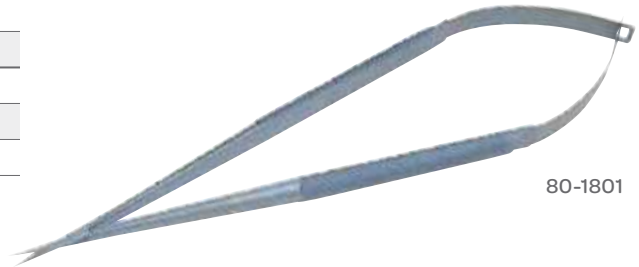

80-1801

## Scissors (Wire)

### Wire Classic Plus® Suture Scissors

Stellite Edge Inserts

CODE	DESCRIPTION	LENGTH
36-5080	Angled	4 ¾ in 121 mm



### Wire Cutting Suture Scissors

CODE	DESCRIPTION	LENGTH
54-4210	Serrated Blade	4 ½ in 114 mm



### Wire Cutting Suture Scissors

One Serrated Jaw

CODE	DESCRIPTION	LENGTH
54-4110	Angled	4 ¾ in 121 mm



## Scissors (Wire)

### Beebee Wire Scissors

One Serrated Blade, Sharp Tips

CODE	DESCRIPTION	LENGTH
14-2410	Straight	4½ in 114 mm



### Schuknecht Wire Cutting Scissors

CODE	DESCRIPTION	LENGTH
14-2009	Wire Cutting Scissors	4 in 102 mm



### Wire Cutting Scissors

One Serrated Jaw

CODE	DESCRIPTION	LENGTH
14-2312	Angled	4¾ in 121 mm



## Scoops (Common Duct)

### Mayo Common Duct Scoop

Silver-Plated

CODE	SIZE	WIDTH	LENGTH
51-1204	Small	4.0 mm	10 in 254 mm
51-1205	Medium	5.0 mm	10 in 254 mm



51-1204

## Scoops (Gall Stone)

### Desjardins Gall Stone Scoop

CODE	DESCRIPTION	LENGTH	
51-1406	18 French, Flexible Shaft	12 in	305 mm

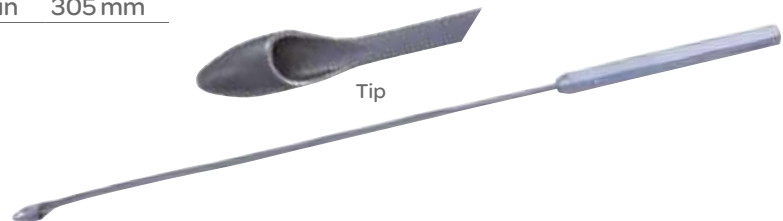

### Fergusson Gall Stone Scoop

Double-Ended

CODE	SIZE	SCOOPS	LENGTH	
51-1501	Small	7.0 mm/9.0 mm	9½ in	241 mm
51-1503	Large	13 mm/14 mm	9½ in	241 mm



## Spatulas

### Davis Brain Spatula

Malleable, Stainless Steel, Double-Ended

CODE	DESCRIPTION		LENGTH	
59-1080	¼ in	6.0 mm	7 in	178 mm
59-1081	⅜ in	10 mm	7 in	178 mm
59-1082	½ in	13 mm	7 in	178 mm
59-1083	⅝ in	16 mm	7 in	178 mm
59-1084	¾ in	19 mm	7 in	178 mm
59-1085	1 in	25 mm	7 in	178 mm
59-1086	1¼ in	32 mm	7 in	178 mm
59-1087	1½ in	38 mm	7 in	178 mm





## Spatulas

### Scoville Brain Spatulas

Malleable, Double Ended

CODE	BLADE WIDTHS	LENGTH
59-1070	$\frac{3}{8}$ in and $\frac{1}{2}$ in	10 mm and 13 mm 8 in 203 mm
59-1071	$\frac{5}{8}$ in and $\frac{3}{4}$ in	16 mm and 19 mm 8 in 203 mm



59-1071

### Spatula

CODE	DESCRIPTION	LENGTH
43-8504	Spatula and Packer	5 $\frac{3}{4}$ in 146 mm
43-8505	Excavator and Packer	5 $\frac{3}{4}$ in 146 mm



43-8504

## Sponges

### Secto® Tonsil Sponges

X-Ray Detectable, Sterile, 5 per A Card/Pouch, 25 Pouches per Dispenser, 2 Dispenser Boxes per Case

CODE	CORD LENGTH	DIAMETER
81-1010	10 in 254 mm	$\frac{5}{8}$ in 16 mm
81-1011	10 in 254 mm	1 in 25 mm
81-1012	10 in 254 mm	1 $\frac{1}{4}$ in 32 mm



81-1011

## Stringers

### Bunts Forceps Holder

CODE	DESCRIPTION	LENGTH
28-4008	One Dozen Per Package	3 $\frac{7}{8}$ in 98 mm



## Stringers

### Instrument Stringer

2½ in (64 mm) Wide

CODE	DESCRIPTION	LENGTH
51-0006	With Bar	6 in 152 mm
51-0006B	With Ball Closure	6 in 152 mm
51-0008	With Bar	8 in 203 mm
51-0008B	With Ball Closure	8 in 203 mm
51-0010	With Bar	10 in 254 mm
51-0010B	With Ball Closure	10 in 254 mm
51-0012	With Bar	12 in 305 mm
51-0016	With Bar	16 in 406 mm



51-0006

### Instrument Stringer

Open Without Bar

CODE	DIMENSIONS	LENGTH
52-0006	2½ x 6 in 64 x 152 mm	6 in 152 mm
52-0008	2½ x 8 in 64 x 203 mm	8 in 203 mm
52-0010	2½ x 10 in 64 x 254 mm	10 in 254 mm
52-0012	2½ x 12 in 64 x 305 mm	12 in 305 mm
52-0014	2½ x 14 in 64 x 356 mm	14 in 356 mm
52-0016	2½ x 16 in 64 x 406 mm	16 in 406 mm

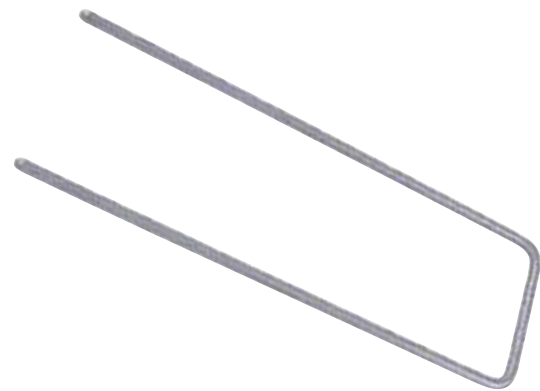

52-0008

### Instrument Stringer

Ball Closure

CODE	DESCRIPTION	LENGTH
ST-6	Stainless Steel	6 in 152 mm
ST-8	Stainless Steel	8 in 203 mm
ST-10	Stainless Steel	10 in 254 mm
ST-12	Stainless Steel	12 in 305 mm
ST-14	Stainless Steel	14 in 356 mm
ST-16	Stainless Steel	16 in 406 mm
ST-18	Stainless Steel	18 in 458 mm
ST-20	Stainless Steel	20 in 508 mm



ST-10

## Stringers

### Posilock Instrument Stringer

With T-Bar

CODE	WIDTH		LENGTH	
50-0006	2½ in	64 mm	6 in	152 mm
50-0008	2½ in	64 mm	8 in	203 mm
50-0010	2½ in	64 mm	10 in	254 mm
50-0012	2½ in	64 mm	12 in	305 mm
50-0014	2½ in	64 mm	14 in	356 mm
50-0016	2½ in	64 mm	16 in	406 mm

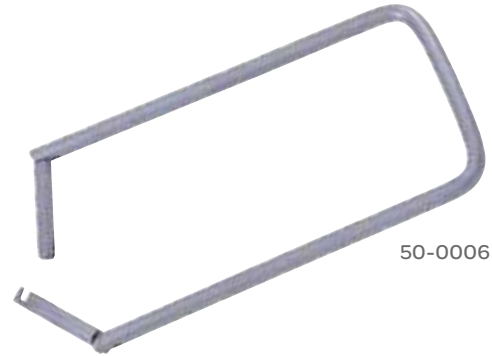

50-0006

### Weisenbach Instrument Stringer

With T-Bar

CODE	WIDTH		LENGTH	
50-0011	2½ in	64 mm	6 in	152 mm
50-0009	2½ in	64 mm	12 in	305 mm



50-0011

### Mayo Instrument Stringer

CODE	DESCRIPTION	LENGTH
46-2810	Instrument Stringer	5½ in 140 mm



### Rhode Island Hospital Instrument Stringer

CODE	DESCRIPTION	LENGTH
21-4003	Instrument Holder	12 in 305 mm



## Stringers

### Instrument Stringer

For Ring Handle Forceps

CODE	DIMENSIONS
32-3346	5 <sup>7</sup> / <sub>8</sub> x 3 <sup>1</sup> / <sub>8</sub> in 149 x 79 mm
32-3347	7 <sup>7</sup> / <sub>8</sub> x 3 <sup>1</sup> / <sub>8</sub> in 200 x 79 mm
32-3348	9 <sup>7</sup> / <sub>8</sub> x 3 <sup>1</sup> / <sub>8</sub> in 251 x 79 mm

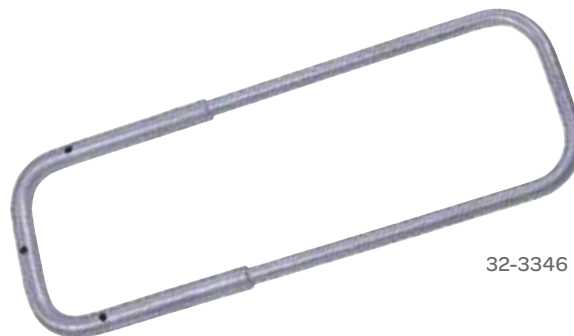

32-3346

### Weinstein Instrument Stringer

CODE	DESCRIPTION	LENGTH
51-0006W	Horseshoe Shape	6 in 152 mm
51-0008W	Horseshoe Shape	8 in 203 mm
51-0010W	Horseshoe Shape	10 in 254 mm
51-0012W	Horseshoe Shape	12 in 305 mm

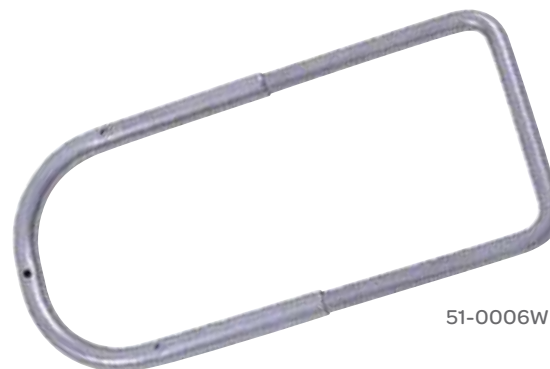

51-0006W

### Weisenbach Instrument Stringer

CODE	DESCRIPTION	LENGTH
28-4010	T-Bar	6 in 152 mm
28-4011	T-Bar	12 in 305 mm



28-4010

## Suction Tubes (Liposuction)

### Liposuction Tube

CODE	DESCRIPTION	SIZE	LENGTH	
52-9301	Straight	3.0 mm #1	6 in	152 mm
52-9303	Straight	4.0 mm #3	9 <sup>7</sup> / <sub>8</sub> in	251 mm
52-9305	Straight	9.0 mm #5	11 <sup>3</sup> / <sub>4</sub> in	298 mm
52-9307	Curved	6.0 mm #7	6 in	152 mm

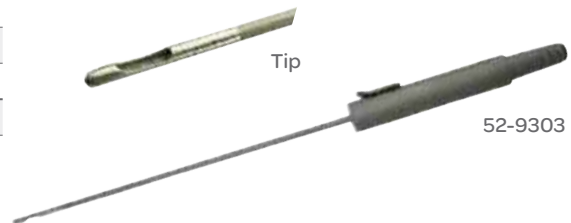

52-9303

## Suction Tubes

### Adson Suction Tube

Curved

CODE	DESCRIPTION	LENGTH	
09-8115	15 French	7 <sup>1</sup> / <sub>2</sub> in	191 mm
09-8110	10 French	8 <sup>1</sup> / <sub>4</sub> in	210 mm
09-8114	14 French	8 <sup>1</sup> / <sub>4</sub> in	210 mm



09-8115

### Adson Suction Tube

Curved, with Thumb Control

CODE	DESCRIPTION	LENGTH	
70-1146	12 French	5 <sup>1</sup> / <sub>2</sub> in	140 mm
70-1148	15 French	7 <sup>1</sup> / <sub>2</sub> in	191 mm



70-1146

## Suction Tubes

### Andrews-Pynchon Suction Tube

CODE	DESCRIPTION	LENGTH	
09-8508	With Removable Tip	9½ in	241 mm
09-8506	With Removable Tip	10½ in	267 mm
09-8509	With Removable Shaft	9½ in	241 mm



09-8508

### Andrews-Pynchon Suction Tube

CODE	DESCRIPTION	LENGTH	
70-6560	Non-Removable Tip	9½ in	241 mm
67-7675	Opti-Length®	11 in	279 mm



67-7675

### Anthony Suction Tube

2.0 mm Diameter

CODE	DESCRIPTION	LENGTH	
61-1067	Straight	10 in	254 mm
09-8510	Angled	10 in	254 mm



09-8510

### Baron Suction Tube

CODE	DESCRIPTION	WORKING LENGTH		LENGTH	
62-2210	3 French	3 in	76 mm	5⅛ in	130 mm
62-2215	5 French	3 in	76 mm	5⅛ in	130 mm
62-2220	7 French	3 in	76 mm	5⅛ in	130 mm
62-2210L	3 French, Long	3½ in	89 mm	6⅛ in	156 mm
62-2215L	5 French, Long	3½ in	89 mm	6⅛ in	156 mm
62-2220L	7 French, Long	3½ in	89 mm	6⅛ in	156 mm

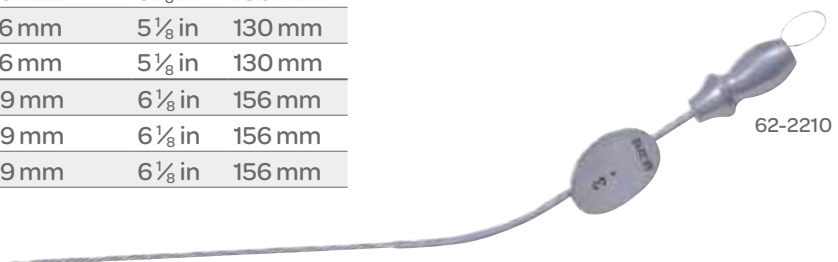

62-2210

## Suction Tubes

### Baron Obturator

CODE	DESCRIPTION	GAUGE
62-2210S	Baron Obturator (Stylet) Wire	3 French
62-2215S	Baron Obturator (Stylet) Wire	5 French
62-2220S	Baron Obturator (Stylet) Wire	7 French



### Brackman Suction Tube

Offset Suction Tip Holes

CODE	DESCRIPTION	LENGTH
09-9505	5 French	3 in 76 mm
09-9507	7 French	3 in 76 mm



### Brand Suction Tube

CODE	DESCRIPTION	LENGTH
50-9826	6.0 mm Diameter	15 3/4 in 400 mm

### DeBakey Suction Tube

CODE	DESCRIPTION	LENGTH
09-8507	Curved	11 in 279 mm



## Suction Tubes

### Ferguson-Frazier Suction Tube

Strong Angle

CODE	DESCRIPTION	LENGTH
61-1021	6 French	4 in 102 mm
61-1022	7 French	4 in 102 mm
61-1023	8 French	4 in 102 mm
61-1024	9 French	4 in 102 mm
61-1025	10 French	4 in 102 mm
61-1026	12 French	4 in 102 mm
61-1027	14 French	4 in 102 mm



61-1021

### Frazier Suction Tube

Medium Angle

CODE	DESCRIPTION	TUBE LENGTH
09-8303	3 French	4 in 102 mm
09-8304	4 French	4 in 102 mm
09-8305	5 French	4 in 102 mm
09-8306	6 French	4 in 102 mm
09-8307	7 French	4 in 102 mm
09-8308	8 French	4 in 102 mm
09-8309	9 French	4 in 102 mm
09-8310	10 French	4 in 102 mm
09-8311	11 French	4 in 102 mm
09-8312	12 French	4 in 102 mm
09-8314	14 French	4 in 102 mm
09-8315	15 French	4 in 102 mm



09-8303

### Frazier Suction Tube

Medium Angle, Extra Long

CODE	DESCRIPTION	TUBE LENGTH
09-8376	6 French	7½ in 191 mm
09-8377	7 French	7½ in 191 mm
09-8378	8 French	7½ in 191 mm
09-8379	9 French	7½ in 191 mm
09-8380	10 French	7½ in 191 mm
09-8381	11 French	7½ in 191 mm
09-8382	12 French	7½ in 191 mm
09-8383	14 French	7½ in 191 mm

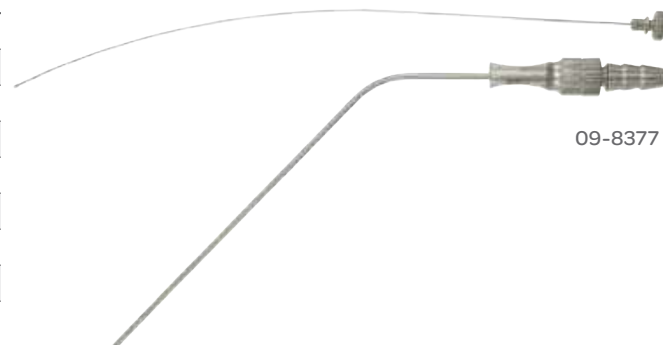

09-8377



## Suction Tubes

### Frazier Suction Tube

Malleable

CODE	DESCRIPTION	LENGTH
09-8603	3 French	7½ in 191 mm
09-8605	5 French	7½ in 191 mm
09-8607	7 French	7½ in 191 mm
09-8608	8 French	7½ in 191 mm
09-8612	12 French	7½ in 191 mm
09-8614	14 French	8½ in 216 mm



### Frazier Suction Tube

Semi-Rigid with Slot

CODE	DESCRIPTION	LENGTH
09-8993	3 French	5½ in 140 mm
09-8995	5 French	5½ in 140 mm
09-8996	6 French	5½ in 140 mm
09-8997	7 French	5½ in 140 mm
09-8999	9 French	5½ in 140 mm
09-9001	11 French	5½ in 140 mm
09-9107	7 French	7 in 178 mm
09-9108	8 French	7 in 178 mm
09-9109	9 French	7 in 178 mm
09-9111	11 French	7 in 178 mm
09-9112	12 French	7 in 178 mm



### Frazier Suction Tube

Straight

CODE	DESCRIPTION	LENGTH
57-3910	6 French	7 in 178 mm
57-3911	7 French	7 in 178 mm
57-3912	8 French	7 in 178 mm
57-3914	10 French	7 in 178 mm
57-3916	12 French	7 in 178 mm
57-3930	7 French, Round Hole	9 in 229 mm
57-3932	9 French, Round Hole	9 in 229 mm
57-3934	11 French, Round Hole	9 in 229 mm



## Suction Tubes

### Frazier Suction Tube

Malleable, Calibration at 5.0-9.0 cm, Angled with Calibration

CODE	GAUGE	TUBE LENGTH	LENGTH
63-7554	4 French	4 in 102 mm	6 <sup>3</sup> / <sub>4</sub> in 171 mm
63-7557	7 French	4 in 102 mm	6 <sup>3</sup> / <sub>4</sub> in 171 mm
63-7558	8 French	4 in 102 mm	6 <sup>3</sup> / <sub>4</sub> in 171 mm
63-7559	9 French	4 in 102 mm	6 <sup>3</sup> / <sub>4</sub> in 171 mm
63-7553	10 French	4 in 102 mm	6 <sup>3</sup> / <sub>4</sub> in 171 mm



### Frazier Suction Tube

Straight with Thumb Control

CODE	DESCRIPTION	TUBE LENGTH
70-1005	Angular Insulated, 9 French	4 <sup>1</sup> / <sub>2</sub> in 114 mm
70-1006	Angular Insulated, 11 French	4 <sup>1</sup> / <sub>2</sub> in 114 mm
70-1079	Angular, 7 French	4 <sup>1</sup> / <sub>2</sub> in 114 mm
70-1080	Angular, 9 French	4 <sup>1</sup> / <sub>2</sub> in 114 mm
70-1100	7 French	5 <sup>1</sup> / <sub>4</sub> in 133 mm
70-1101	9 French	5 <sup>1</sup> / <sub>4</sub> in 133 mm
70-1102	11 French	5 <sup>1</sup> / <sub>4</sub> in 133 mm



### Frazier Suction Tube Stylet

CODE	DESCRIPTION
09-8336	6 French, for 09-8306
09-8337	7 French, for 09-8307
09-8338	8 French, for 09-8308
09-8339	9 French, for 09-8309
09-8340	10 French, for 09-8310
09-8342	12 French, for 09-8312
09-8343	14 French, for 09-8314

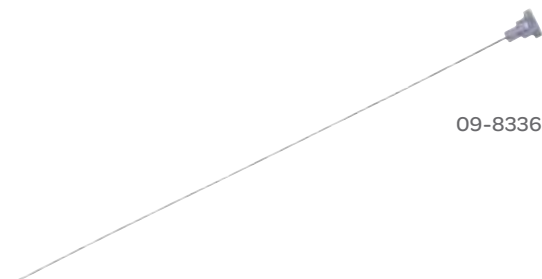

## Suction Tubes

### Fukushima Tapered Teardrop Suction Tube

Malleable

CODE	DESCRIPTION	LENGTH
67-7850	4 French	6¼ in 159 mm
67-7851	5 French	6¼ in 159 mm
67-7852	6 French	6¼ in 159 mm
67-7853	7 French	6¼ in 159 mm
67-7854	8 French	6¼ in 159 mm
67-7855	9 French	6¼ in 159 mm



67-7850

### Fukushima Tapered Teardrop Suction Tube

Malleable

CODE	DESCRIPTION	LENGTH
67-7856	4 French	7 in 178 mm
67-7857	5 French	7 in 178 mm
67-7858	6 French	7 in 178 mm
67-7859	7 French	7 in 178 mm
67-7860	8 French	7 in 178 mm
67-7861	9 French	7 in 178 mm



67-7856

### Fukushima Tapered Teardrop Suction Tube

Malleable

CODE	DESCRIPTION	LENGTH
67-7862	4 French	8 in 203 mm
67-7863	5 French	8 in 203 mm
67-7864	6 French	8 in 203 mm
67-7865	7 French	8 in 203 mm
67-7866	8 French	8 in 203 mm
67-7867	9 French	8 in 203 mm



67-7862

## Suction Tubes

### Fukushima Tapered Teardrop Suction Tube

Malleable

CODE	DESCRIPTION	LENGTH
67-7868	4 French	9 in 229 mm
67-7869	5 French	9 in 229 mm
67-7870	6 French	9 in 229 mm
67-7871	7 French	9 in 229 mm
67-7872	8 French	9 in 229 mm
67-7873	9 French	9 in 229 mm

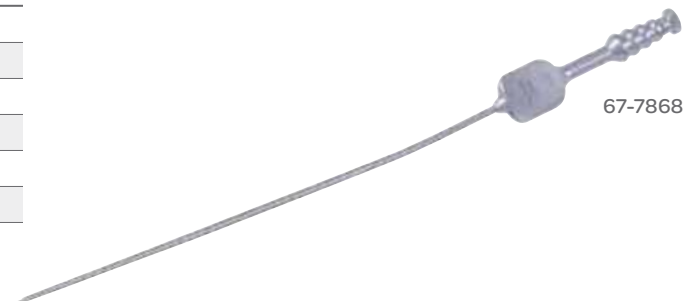

67-7868

### Grafting Suction Tube

CODE	DESCRIPTION	LENGTH
09-8511	3.0 mm Tip	9½ in 241 mm

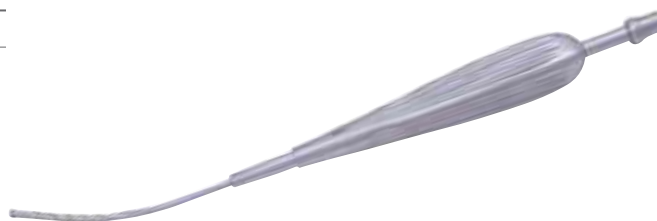

### Guilford-Wright Suction Tube

With Obturator that Extends 6.0 mm Beyond Tube

CODE	DESCRIPTION	LENGTH
61-1050	18 Gauge	4 in 102 mm
61-1053	24 Gauge	4 in 102 mm



61-1050

## Suction Tubes

### Hardy™ Suction Tube

Angled, with Thumb Control, Insulated

CODE	DESCRIPTION	LENGTH
80-1360	7 French, Curved Left	7¼ in 184 mm
80-1361	7 French, Curved Right	7¼ in 184 mm

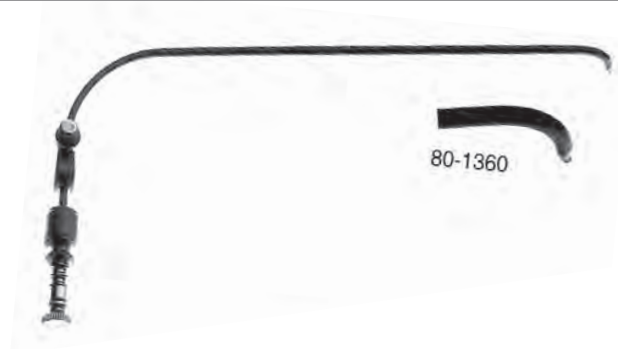

### Verity™-Frazier Suction Tube

Black Anodized

CODE	DESCRIPTION	LENGTH
70-1103	7 French	4¼ in 108 mm
70-1104	7 French	7½ in 191 mm



### Methodist Vascular Suction Tube

CODE	DIAMETER	LENGTH
70-8040	⅜ in 10 mm	10 in 254 mm



### Pacifico Suction Tube

Diameter Tapers 11-8 French

CODE	DESCRIPTION	LENGTH
70-8048	Large	7½ in 191 mm



## Suction Tubes

### Poole Suction Tube

CODE	DESCRIPTION	LENGTH	
09-8717	17 French, Straight	8 in	203 mm
09-8730	30 French, Straight	8 <sup>3</sup> / <sub>4</sub> in	222 mm
09-8799	30 French, Straight	12 in	305 mm
09-8800	30 French, Straight	14 in	356 mm
70-4001	30 French, Straight Tubing Connection	9 <sup>5</sup> / <sub>8</sub> in	244 mm
70-4002	30 French, Straight Tubing Connection, with Finger Cut-Off	10 <sup>1</sup> / <sub>4</sub> in	260 mm
09-8823	23 French, Curved	8 <sup>3</sup> / <sub>4</sub> in	222 mm
70-4000	23 French, Curved Tubing Connection	9 <sup>1</sup> / <sub>4</sub> in	235 mm



70-4000

### Suction Tube

CODE	WORKING DISTANCE		LENGTH	
32-3360	9 <sup>3</sup> / <sub>4</sub> in	248 mm	12 in	305 mm
32-3361	12 <sup>3</sup> / <sub>4</sub> in	324 mm	15 in	381 mm



32-3360

### Pribram Suction Tube with Thumb Control

CODE	DESCRIPTION	LENGTH	
70-1128	16 Gauge	5 <sup>1</sup> / <sub>2</sub> in	140 mm
70-1130	18 Gauge	5 <sup>1</sup> / <sub>2</sub> in	140 mm



70-1128

## Suction Tubes

### Rhoton® Suction Tube

Angled Tube

CODE	GAUGE	TIP	LENGTH
58-6303	3 French	Straight	3¼ in 83 mm
58-6305	5 French	Straight	3¼ in 83 mm
58-6307	7 French	Straight	3¼ in 83 mm
58-6310	10 French	Straight	3¼ in 83 mm
58-6311	12 French	Straight	3¼ in 83 mm
58-6313	3 French	Straight	4 in 102 mm
58-6315	5 French	Straight	4 in 102 mm
58-6317	7 French	Straight	4 in 102 mm
58-6320	10 French	Straight	4 in 102 mm
58-6322	12 French	Straight	4 in 102 mm
58-6327	7 French	Straight	5½ in 140 mm
58-6330	10 French	Straight	5½ in 140 mm
58-6331	12 French	Straight	5½ in 140 mm
58-6335	5 French	Curved Up	5¼ in 133 mm
58-6337	7 French	Curved Up	5¼ in 133 mm
58-6340	10 French	Curved Up	5¼ in 133 mm



### Rosen Suction Tube

CODE	DESCRIPTION	LENGTH
61-1035	15 Gauge	2¾ in 60 mm
61-1036	16 Gauge	2¾ in 60 mm
61-1037	17 Gauge	2¾ in 60 mm
61-1038	18 Gauge	2¾ in 60 mm
61-1039	19 Gauge	2¾ in 60 mm
61-1040	20 Gauge	2¾ in 60 mm
61-1041	22 Gauge	2¾ in 60 mm
61-1042	24 Gauge	2¾ in 60 mm
61-1043	26 Gauge	2¾ in 60 mm



## Suction Tubes

### Sachs Pediatric Suction Tube

CODE	DESCRIPTION
09-8520	#1, Fixed Tip, Fluted



### Sachs Suction Tube

Angled, with Finger Valve and Obturator

CODE	DESCRIPTION	WORKING LENGTH
09-1970	10 French	4 in 102 mm
09-1980	15 French	4 in 102 mm



### Sachs Suction Tube

CODE	DESCRIPTION	SHAFT LENGTH	TIP LENGTH
70-1160	Small, 8 French	9 <sup>5</sup> / <sub>8</sub> in 244 mm	4 in 102 mm
70-1161	Large, 15 French	9 <sup>5</sup> / <sub>8</sub> in 244 mm	4 <sup>1</sup> / <sub>2</sub> in 114 mm

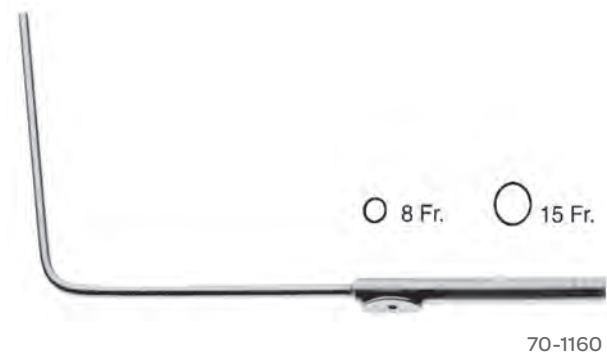



# Suction Tubes

## Sarns Suction Tube

CODE	DESCRIPTION
09-6600	#1 Fixed Tip, Fluted



## Schuknecht Suction Tube

CODE	GAUGE	LENGTH
62-2230	20 Gauge	5 ¼ in 133 mm
62-2231	24 Gauge	5 ¼ in 133 mm



62-2231

## Tear-Drop Suction Tube

Angled Tapered Tube, Malleable

CODE	GAUGE	WORKING LENGTH	LENGTH
57-4063	3 French	5 in 127 mm	6 in 152 mm
57-4064	4 French	5 in 127 mm	6 in 152 mm
57-4065	5 French	5 in 127 mm	6 in 152 mm
57-4066	6 French	5 in 127 mm	6 in 152 mm
57-4067	7 French	5 in 127 mm	6 in 152 mm
57-4068	8 French	5 in 127 mm	6 in 152 mm
57-4069	9 French	5 in 127 mm	6 in 152 mm
57-4070	10 French	5 in 127 mm	6 in 152 mm
57-4072	12 French	5 in 127 mm	6 in 152 mm
57-4073	3 French	6 in 152 mm	7 in 178 mm
57-4074	4 French	6 in 152 mm	7 in 178 mm
57-4075	5 French	6 in 152 mm	7 in 178 mm
57-4083	3 French	7 in 178 mm	8 in 203 mm
57-4086	6 French	7 in 178 mm	8 in 203 mm
57-4088	8 French	7 in 178 mm	8 in 203 mm
57-4090	10 French	7 in 178 mm	8 in 203 mm
57-4092	12 French	7 in 178 mm	8 in 203 mm



57-4065

## Suction Tubes

### Tear-Drop Suction Tube

CODE	GAUGE	LENGTH
57-4044	4 French	9 in 229 mm
57-4045	5 French	9 in 229 mm
57-4046	6 French	9 in 229 mm
57-4047	7 French	9 in 229 mm
57-4049	9 French	9 in 229 mm



57-4046

### Vascular Suction Tube

#### Round Perforated End

CODE	DIAMETER	LENGTH
70-8036	¼ in 6.0 mm	11½ in 292 mm



### Yankauer Suction Tube

CODE	DESCRIPTION	LENGTH
09-8504	Small Pattern, Narrow Handle	8¼ in 210 mm
09-8500		10¼ in 260 mm
70-4026	Standard Pattern, Removable Tip	10⅜ in 264 mm
70-4024	Thumb Control	11¼ in 286 mm
09-8599		12 in 305 mm
32-3362	Thumb Control, Tube Length 5⅞ in (149 mm)	12¾ in 324 mm
09-8600		14 in 356 mm
09-8640		16 in 405 mm



09-8500

## Suction Tubes

### Yasargil Micro Suction Tube

CODE	DESCRIPTION	LENGTH
80-1621	Medium, 2.5 mm Outer Diameter	14 in 356 mm
80-1622	Large, 3.5 mm Outer Diameter	14 in 356 mm



80-1621

## Trocars

### Ochsner Trocar

Round Perforated End

CODE	GAUGE	LENGTH
09-5812	12 French	6 in 152 mm
09-5818	18 French	6 in 152 mm
09-5822	22 French	6 in 152 mm
09-5824	24 French	6 in 152 mm

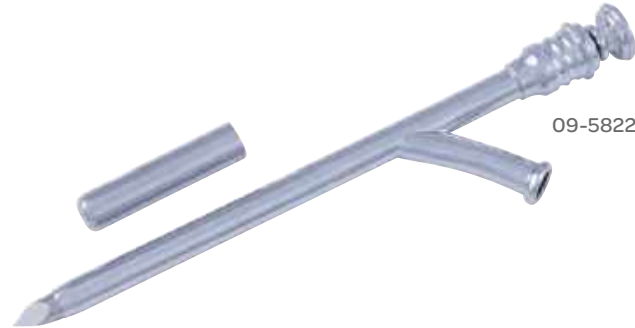

09-5822

## Wire & Pin Cutters

### Double Action Wire Cutter Side Cutter

CODE	DESCRIPTION	LENGTH
32-3371	Straight Jaw	9 in 229 mm
32-3372	Angled Jaw	6 ½ in 165 mm
32-3373	Angled Jaw	9 in 229 mm



32-3372

## Wire & Pin Cutters

### Kirschner Wire Cutter

CODE	DESCRIPTION	LENGTH
56-2507	Chrome Plated	11¼ in 286 mm



## Wire Twisters

### Wire Twister

Blunt Tips, Ring Handle

CODE	DESCRIPTION	LENGTH
32-122	Tungsten Carbide Inserts with Sternal Needles and Wire up to 18 Gauge	6 in 152 mm
32-123	Tungsten Carbide Inserts	7¼ in 184 mm



32-122