

---

# GREENWORKS

## COMMERCIAL

### 82V RECHARGEABLE LITHIUM-ION BATTERY

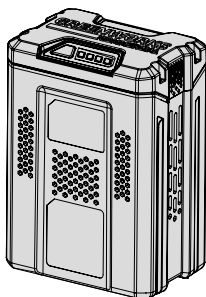

82VDC 205Wh  
Rechargeable Li-ion Battery  
(Model#: GL 250)

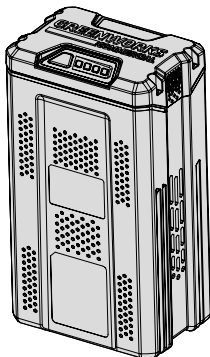

82VDC 328Wh  
Rechargeable Li-ion Battery  
(Model#: GL 400)  
82VDC 410Wh  
Rechargeable Li-ion Battery  
(Model#: GL 500)

Owner's Manual

**TOLL-FREE HELPLINE: 1-855-470-4267**  
[www.greenworkstools.com/82v-Commercial/](http://www.greenworkstools.com/82v-Commercial/)

---

 Read all safety rules and instructions carefully before operating this tool.

# CONTENTS

---

Product Specifications .....	2
Important Safety Instructions .....	3
Symbols .....	4
Know Your Battery .....	5
Operation .....	6
Maintenance .....	9
Troubleshooting .....	10
Environmentally Safe Battery Disposal .....	11
Limited Warranty .....	12

## PRODUCT SPECIFICATIONS

---

COMPONENTS	SPECIFICATIONS
Battery	82V Rechargeable Lithium-ion Battery
Model	GL 200
Rating	82V DC 164Wh
Charge time	30 min.
Weight	3.26 lbs (1.48 kg)
Battery	82V Rechargeable Lithium-ion Battery
Model	GL 250
Rating	82V DC 205Wh
Charge time	36 min.
Weight	3.26 lbs (1.48 kg)
Battery	82V Rechargeable Lithium-ion Battery
Model	GL 300
Rating	82V DC 246Wh
Charge time	45 min.
Weight	3.26 lbs (1.48 kg)
Battery	82V Rechargeable Lithium-ion Battery
Model	GL 400
Rating	82V DC 328Wh
Charge time	60 min.
Weight	5.56 lbs (2.52 kg)
Battery	82V Rechargeable Lithium-ion Battery
Model	GL 500
Rating	82 V DC 410Wh
Charge time	75 min.
Weight	5.56 lbs (2.52 kg)

# IMPORTANT SAFETY INSTRUCTIONS

---

## **⚠ WARNING**

Read all safety warnings and instructions. Failure to follow the warnings and instructions may result in electric shock, fire and/or serious injury.

---

## **⚠ WARNING**

For use only with Greenworks Li-ion Battery Charger (GC 400).



---

- When charging, make sure temperature is between 6-40°C(43-104°F), -17-45°C(1.4-113°F) for discharge.
- Keep battery out of reach of children.
- Do not use a damp cloth or detergent on the battery or battery charger.
- Always remove the battery pack before cleaning, inspecting, or performing any maintenance on the tool.
- Have servicing performed by a qualified repair person using only identical replacement parts. This will ensure that the safety of the product is maintained.
- If the battery pack case is cracked or damaged, do not insert into the charger. Replace the battery pack.
- Battery tools do not have to be plugged into an electrical outlet; therefore, they are always in operating condition. Be aware of possible hazards when not using your battery tool or when changing accessories. Following this rule will reduce the risk of electric shock, fire, or serious personal injury.
- Do not place the battery in high-temperature locations, such as near a fire, heater, etc.
- Do not crush, drop or damage battery pack. Do not use a battery pack or charger that has been dropped or received a sharp blow. A damaged battery is subject to explosion.
- Batteries can explode in the presence of a source of ignition, such as a pilot light. To reduce the risk of serious personal injury, never use any cordless product in the presence of open flame. An exploded battery can propel debris and chemicals. If exposed, flush with water immediately.
- Do not charge battery tool in a damp or wet location. Following this rule will reduce the risk of electric shock.
- Under extreme usage or temperature conditions, battery leakage may occur. If liquid comes in contact with your skin, wash immediately with soap and water. If liquid gets into your eyes, flush them with clean water for at least 15 minutes, then seek immediate medical attention. Following this rule will reduce the risk of serious personal injury.
- Keep battery pack dry, clean, and free from oil and grease. Always use a clean cloth when cleaning. Never use brake fluids, gasoline, petroleum-based products, or any solvents to clean battery pack.
- Dispose of used battery promptly.
- Do not disassemble and do not dispose of in fire.
- Do not mix old and new batteries and do not mix alkaline, standard (carbonzinc) or rechargeable (ni-cad, ni-mh, etc.) batteries.



# SYMBOLS

---

Some of the following symbols may be used on this product. Please study them and learn their meaning. Proper interpretation of these symbols will allow you to operate the product better and safer.

SYMBOL	NAME	DESIGNATION/EXPLANATION
V	Volts	Voltage
Hz	Hertz	Frequency (cycles per second)
W	Watts	Power
—	Direct Current	Type or a characteristic of current
	Wet Conditions Alert	Do not expose to rain or use in damp locations.
	Read The Operator's Manual	To reduce the risk of injury, user must read and understand operator's manual before using this product.
	Safety Alert	Precautions that involve your safety.

The following signal words and meanings are intended to explain the levels of risk associated with this product.

SYMBOL	SIGNAL	MEANING
	<b>DANGER</b>	Indicates an imminently hazardous situation, which, if not avoided, will result in death or serious injury.
	<b>WARNING</b>	Indicates a potentially hazardous situation, which, if not avoided, could result in death or serious injury.
	<b>CAUTION</b>	Indicates a potentially hazardous situation, which, if not avoided, may result in minor or moderate injury.
	<b>CAUTION</b>	(Without Safety Alert Symbol) Indicates a situation that may result in property damage.

# KNOW YOUR BATTERY

---

The safe use of this product requires an understanding of the information on the product and in this operator's manual as well as a knowledge of the project you are attempting. Before using this product, familiarize yourself with all operating features and safety rules.

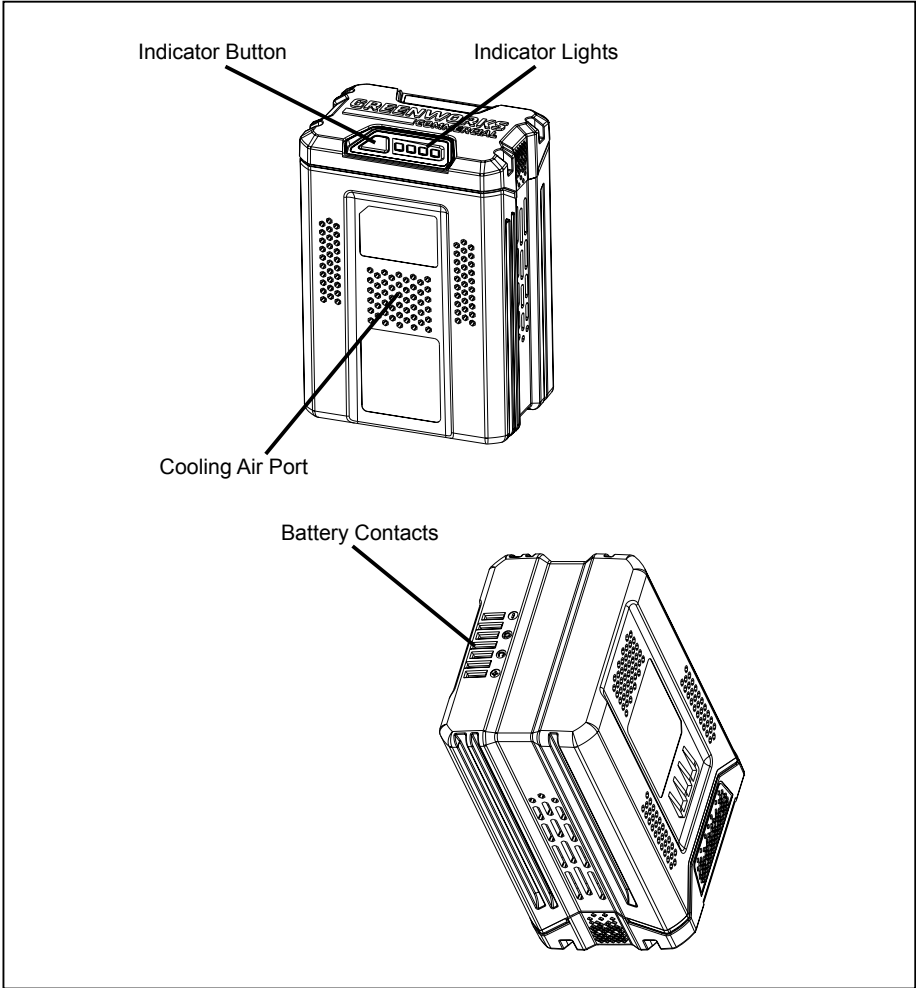

# OPERATION

---

---

## **⚠ CAUTION**

Risk of Fire and Burns. Do Not Open, Crush, Heat Above 100°C(212°F) or Incinerate. Follow Manufacturer's Instructions.

---

---

## **⚠ CAUTION**

When battery pack is not in use, keep it away from other metal objects, like paper clips, coins, keys, nails, screws or other small metal objects, that can make a connection from one terminal to another. Shorting the battery terminals together may cause burns or a fire.

---

---

## **⚠ CAUTION**

Under abusive conditions, liquid may be ejected from the battery; avoid contact. If contact accidentally occurs, flush with water. If liquid contacts eyes, additionally seek medical help. Liquid ejected from the battery may cause irritation or burns.

---

---

## **⚠ CAUTION**

Do not use a battery pack that is damaged or modified. Damaged or modified batteries may exhibit unpredictable behavior resulting in fire, explosion or risk of injury.

---

# OPERATION

---

## CHECKING BATTERY CAPACITY

*Note:* The battery is not shipped fully charged. It is recommended to fully charge before first use to ensure that maximum run time can be achieved. This lithium-ion battery will not develop a memory and may be charged at any time. A fully discharged battery pack will require approximately 30 minutes to fully charge from a discharged state.

Press the battery capacity indicator (BCI) button. The lights will illuminate according to the batteries capacity level. See chart below:

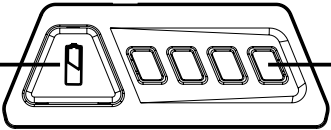

The diagram shows a battery pack with a BCI button on the left and a light meter on the right. The light meter consists of four rectangular slots. Labels 'BATTERY CAPACITY INDICATOR (BCI) BUTTON' and 'LIGHT METER' are connected to their respective parts by lines.

Lights	Capacity
4 Green Lights	The battery is above 80% capacity
3 Green Lights	The battery is between 80% and 60% capacity
2 Green Lights	The battery is between 60% and 40% capacity
1 Green Light	The battery is between 40% and 25% capacity
Lights go out	The battery is less than 25% capacity and requires charging immediately

## BATTERY PROTECTION FEATURES

GW 82V lithium-ion battery packs are designed with features that protect the lithium-ion cells and maximize battery life.

If the tool stops during use, release the trigger to reset and resume operation. If the tool still does not work, the battery needs to be recharged.

## COLD WEATHER OPERATION

The lithium-ion battery pack can be used in temperatures down to -20°C(-4°F). Put the battery pack on a tool and use the tool in a light duty application. After about a minute, the pack will warm up and begin operating normally.

# OPERATION

---

## **CHARGING THE BATTERY PACK**

Battery packs are shipped in a low charge condition to prevent possible problems. Therefore, you should charge prior to first use. If the charger does not charge the battery pack under normal circumstances, return both the battery pack and charger to your nearest Authorized Service Center for electrical check.

- Charge the battery pack only with the recommended charger.
- Connect the charger to a power supply. For approved power sources, refer to the operator's manual for the charger.
- Make sure the battery pack is secured in the charger before beginning operation.
- Press down on the battery pack to be sure contacts on the battery pack engage properly with contacts in the charger.
- The battery pack may become slightly warm to the touch while charging. This is normal and does not indicate a problem.
- Do not place the charger and battery pack in an area of extreme heat or cold. They will work best at normal room temperature.
- When batteries become fully charged, unplug the charger from the power supply and remove the battery pack.



# MAINTENANCE

---

## **⚠ WARNING**

To avoid serious personal injury, always remove the battery pack from the tool when cleaning or performing any maintenance.

---

## **⚠ WARNING**

When servicing, use only identical GW replacement parts. Use of any other parts may create a hazard or cause product damage.

---

## **⚠ WARNING**

It is not recommended to use compressed dry air as cleaning method of the charger. If cleaning with compressed air is the only method to apply, always wear safety goggles or safety glasses with side shields when using compressed air to clean the tool. If the operation is dusty, also wear a dust mask.

---

## **GENERAL MAINTENANCE**

- Brush or blow dust and debris out of the air vents using compressed air or a vacuum. Keep the air vents free of obstructions, sawdust, and wood chips. Do not spray, wash, or immerse the air vents in water.
- Wipe off the housing and the plastic components using a dry, soft cloth. Do not use strong solvents or detergents on the plastic housing or plastic components. Certain household cleaners may cause damage and may cause a shock hazard.

## **STORAGE**

- Always remove the battery pack before storing the charger or any time the charger is unplugged.
  - Do not place the battery pack in the sun or in a warm environment. Keep at normal room temperature.
  - If the battery will not be used for 3 months or more, please store the battery in a room temperature environment. Please fully charge before storage.
- 

## **⚠ WARNING**

Do not at any time let brake fluids, gasoline, petroleum-based products, penetrating oils, etc. to come in contact with plastic parts. Chemicals can damage, weaken or destroy plastic which may result in serious personal injury.

---

# TROUBLESHOOTING

---

<b>PROBLEM</b>	<b>CAUSE</b>	<b>SOLUTION</b>
The battery pack charge is reduced after more than one month of non-use.	The battery pack has automatically performed self-maintenance to extend its life.	Fully recharge the battery pack before use.

# ENVIRONMENTALLY SAFE BATTERY DISPOSAL

---

The following toxic and corrosive materials are in the batteries used in this battery pack:  
**Lithium-Ion, a toxic material.**



---

## **⚠ WARNING**

All toxic materials must be disposed of in a specified manner to prevent contamination of the environment. Before disposing of damaged or worn out Lithium-Ion battery packs, contact your local waste disposal agency, or the local Environmental Protection Agency for information and specific instructions. Take the batteries to a local recycling and/or disposal centre, certified for lithium-ion disposal.

---

---

## **⚠ WARNING**

If the battery pack cracks or breaks, with or without leaks, do not recharge it and do not use. Dispose of it and replace with a new battery pack. **DO NOT ATTEMPT TO REPAIR IT!** To avoid injury and risk of fire, explosion, or electric shock, and to avoid damage to the environment:

- Cover the battery's terminals with heavy-duty adhesive tape.
  - DO NOT attempt to remove or destroy any of the battery pack components.
  - DO NOT attempt to open the battery pack.
  - If a leak develops, the released electrolytes are corrosive and toxic. DO NOT get the solution in the eyes or on skin, and do not swallow it.
  - DO NOT place these batteries in your regular household trash.
  - DO NOT incinerate.
  - DO NOT place them where they will become part of any waste landfill or municipal solid waste stream.
  - Take them to a certified recycling or disposal centre.
-

# LIMITED WARRANTY

---



GREENWORKS™ battery hereby warrants this product, to the original purchaser with proof of purchase, for a period of one (1) year against defects in materials, parts or workmanship.

GREENWORKS™, at its own discretion will repair or replace any and all parts found to be defective, through normal use, free of charge to the customer. This warranty is valid only for units which have been used for personal use that have not been hired or rented for industrial/commercial use, and that have been maintained in accordance with the instructions in the owners' manual supplied with the product from new.

## **1 Year Limited Battery Warranty Coverage:**

- Greenworks Commercial Battery Packs (GL 200, GL 250, GL 300, GL 400, GL 500, GL 900)
- 1 year from the date of purchase (non transferable)

## **Warranty Exclusions, Limitations and Rights:**

1. All warranties may not be transferred by the consumer to any subsequent purchaser.
2. Parts or components not supplied by the warrantor, or parts or components that have been modified.
3. Any failure resulting from the use of improper tools or improper repair procedures.
4. Any failure or part that has become inoperative due to accident, impact, abuse, misuse, neglect, mishandling, dulling of cutting edges, or failure to operate the product in accordance with the information provided in the instruction manual supplied with the product.
5. Normal deterioration of the exterior due to use or exposure, and any repairs made necessary by normal wear, improper maintenance, improper lubrication, improper storage, dirt, abrasives, impact, moisture, water, rain, snow, rust, corrosion, varnish, or other similar conditions.
6. Routine maintenance items such as lubricants, blade sharpening.
7. The unit, if it has not been operated and/or maintained in accordance with the owner's manual.
8. Improper voltage for electric products and batteries that have been exposed to temperatures beyond those specified in the product's instruction manual, batteries that have not been properly charged or batteries that have reached their useful life.

# LIMITED WARRANTY

---

**GREENWORKS HELPLINE:**

Warranty service is available by calling our toll-free helpline, at **1-855-470-4267**.

**TRANSPORTATION CHARGES:**

Transportation charges for the movement of any power equipment unit or attachment are the responsibility of the purchaser. It is the purchaser's responsibility to pay transportation charges for any part submitted for replacement under this warranty unless such return is requested in writing by **GREENWORKS**.

# **GREENWORKS**

---

## **COMMERCIAL**

**Greenworks Tools  
PO Box 1238  
 Mooresville, NC 28115**

**TOLL-FREE HELPLINE: 1-855-470-4267**

Rev: 00 (08-25-16)