

greenworks **pro**[™]

7406002/ 7407102/
7503802

EN

LAWN VEHICLE

OPERATOR MANUAL

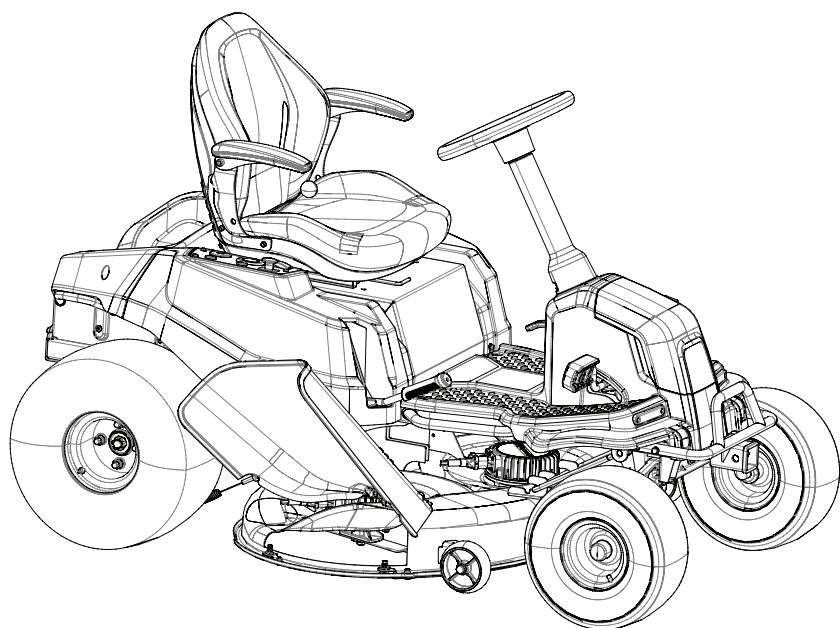



**RLV42M60/ RLV42M80/
RLV42M82 (7503802)**

www.greenworkstools.com
www.greenworkscommercial.com

REGISTRATION:

- As the original owner, be sure to register your product (vehicle, batteries & chargers) at following product pages on our Greenworks website(s):



ERP	MODEL	VOLTAGE	DESCRIPTION	PRODUCT PAGES	QR CODE
7406002	RLV42M60	60-volt	Greenworks Pro 42-inch 60-volt Lawn Vehicle	https://www.greenworkstools.com/pro-60v-42-inch-rlv-lawn-vehicle-7406002	
7407102	RLV42M80	80-volt	Greenworks Pro 42-inch 80-volt Lawn Vehicle	https://www.greenworkstools.com/pro-80v-42-inch-rlv-lawn-vehicle-7407102	
7503802	RLV42M82	82-volt	Greenworks Pro 42-inch 82-volt Lawn Vehicle	https://greenworkscommercial.com/pro-82v-42-inch-rlv-lawn-vehicle-7503802	

- **WARNING: To reduce the risk of injury, the user must read and understand the Operator’s Manual before using this product. Save these instructions for future reference.**
- We are constantly improving our machines so please find the latest information on it online. Printed manuals can be out of date, so for latest tips and safety always check the online manuals before using the machine.
 - Troubleshooting guides are also online or in the app [link] which can be found in the app store.
 - Videos of uncrating, best practices, and routine maintenance can be found online.

1 Risk levels.....	2	8.2 Operate the machine.....	10
2 Read all instructions.....	2	9 Fault code.....	14
2.1 Operator.....	2	10 Maintenance.....	16
2.2 Machine.....	2	10.1 Tires.....	16
2.3 Mowing area.....	3	10.2 Mower blade maintenance.....	16
2.4 Mowing.....	3	10.3 Replace the headlight.....	18
2.5 Servicing.....	3	10.4 Lubrication.....	18
2.6 Child safety.....	3	10.5 Torque values.....	18
2.7 Use a ramp.....	4	10.6 Battery pack maintenance.....	18
2.8 Towing.....	4	10.7 Service.....	18
2.9 Battery and charger.....	4	11 Transportation and storage.....	19
3 Symbols on the product.....	4	11.1 Transportation.....	19
4 Environmentally safe battery disposal.....	5	12 Cleaning and storage.....	19
5 Proposition 65.....	6	12.1 Clean the machine.....	20
6 Description.....	6	12.2 Store the machine.....	20
6.1 Purpose.....	6	12.3 Prepare for use after storage.....	20
6.2 Overview.....	6	13 Troubleshooting.....	21
6.3 Control panel.....	6	14 Technical data.....	23
7 Installation.....	7	15 Warranty.....	23
7.1 Unpack the machine.....	7	15.1 ITEMS NOT COVERED BY WARRANTY:.....	24
7.2 Install the seat.....	7	15.2 HELPLINE:.....	24
7.3 Install the steering wheel.....	7	15.3 TRANSPORTATION CHARGES:.....	24
7.4 Install the accessories.....	8	16 Greenworks Product Registration:.....	25
8 Operation.....	8	17 Serial Number(s).....	26
8.1 Before operation.....	9		

1 RISK LEVELS

The following signal words and meanings are intended to explain the levels of risk associated with this product.

SYMBOL	SIGNAL	MEANING
	DANGER	Indicates an imminently hazardous situation, which, if not avoided, will result in death or serious injury.
	WARNING	Indicates a potentially hazardous situation, which, if not avoided, could result in death or serious injury.
	CAUTION	Indicates a potentially hazardous situation, which, if not avoided, may result in minor or moderate injury.
	CAUTION	(Without Safety Alert Symbol) Indicates a situation that may result in property damage.

2 READ ALL INSTRUCTIONS

▲ WARNING

This symbol indicates important safety instructions. If these instructions are not followed, it could endanger the personal safety and/or property of the operator and others. Read and understand all instructions in this manual before attempting to operate the mower. Failure to comply with these instructions may result in personal injury.

▲ DANGER

This mower was built to be operated according to the rules for safe operation that are contained in this manual. As with any type of power equipment, carelessness or error on the part of the operator can result in serious injury. This mower is capable of amputating body parts and throwing objects. Failure to observe the following safety rules could result in serious injury or death.

▲ WARNING

Basic safety precautions should always be followed when using lawnmowers in order to reduce the risk of fire, electric shock, and personal injury.

▲ WARNING

Use of this mower should be restricted to individuals who have read and understand and will follow the warnings and instructions that are printed in this manual and on the mower.

▲ WARNING

- Carefully read all instructions on the mower and in the manual before attempting to assemble and operate the mower.
- For safe operation, read, understand, and follow all instructions in this manual.
- Become familiar with all controls and their proper operation. Know how to stop the mower and how to disengage the power in an emergency.
- Keep this manual in a safe place for reference and consult it regularly.

2.1 OPERATOR

- Only allow responsible, capable adults who are familiar with the instructions to operate this machine.
- Safe operation requires your full attention and capabilities.
- Always look where you are going and be aware of your surroundings.
- Listen to the machine and be aware of any change.
- Feel the machine and its responses from both your inputs and the environment.
- Remain focused on your task.
- Always wear proper eye protection that complies with the latest safety standards in order to reduce the risk of eye injury while operating or performing any adjustment or repair. See ANSI Z87.1.
- Do not operate machine unless discharge guard or other safety devices are in place and working.
- Always wear a face mask or a dust mask while operating the mower in a dusty environment.
- Always dress properly. The wearing of protective gloves and safety footwear is recommended.
- Do not wear radios or music headphones while operating the machinery.
- Do not operate the equipment while wearing sandals, tennis shoes, sneakers, shorts or any type of loose-fitting clothing. Long hair, loose clothing or jewelry may get tangled in moving parts. Always wear long pants, safety glasses, ear protection and safety shoes while operating this machine.
- Stay alert! Do not operate the mower when you are tired. Do not operate the mower while under the influence of alcohol or drugs. Pay attention to what you are doing. Use common sense.
- Never carry passengers.
- Follow the manufacturer's recommendation for wheel weights or counterweights.

2.2 MACHINE

- Never operate a poorly maintained machine.
- Always keep safety shields and covers in place.
- Follow daily and weekly checklists, making sure electrical connections are secured and bolts are tightened.

- Replace damaged parts immediately.
- Never operate mower without a proper trail shield, discharge cover, switch control, or other safety device in place and in working order. Do not operate the mower with damaged safety devices; doing so can result in injury.
- Repair or replace any damaged components before restarting and operating the lawnmower.
- Only use approved replacement parts.
- Minimize exposure to water. Do not drive into water. Do not leave in rain. Do not clean with pressurized water or hose.
- Always store your lawnmower indoors. When not in use, the mower should be stored indoors in a dry and locked place, out of reach of children.
- Do not mow in reverse unless absolutely necessary.
- When moving in reverse, SLOWLY pull right and left Drive Control Levers rearward and avoid sudden movements. Rapid movement of the Drive Control Levers in either direction could result in a reaction of the machine that can cause serious injury.
- Do not put hands or feet near rotating parts or under the cutting deck. Contact with the blade can amputate hands and feet.
- If the mower starts to vibrate excessively, stop the motor and check for the cause immediately. Excessive vibration is generally a sign the mower is not functioning properly.
- Stop the motor and wait until the blade comes to a complete stop before unclogging the chute. The cutting blade will continue to rotate for a few seconds after the motor is shut off. Do not place any part of your body in the blade area until you are sure that the blade has stopped rotating.
- If lawnmower strikes a foreign object, stop the machine, rotate the ignition switch to "OFF" position, then, if it is safe, inspect for damage.
- Don't force the lawnmower.
- Do not use the mower for any job except that for which it is intended.

2.3 MOWING AREA

- Before mowing any area, thoroughly inspect the area for any hazards. Walk the area to ensure there is adequate traction and no holes, drop-offs, or hidden objects that could cause issues. Clear the area of objects such as rocks, wire, toys, etc., which could be thrown by the blades.
- Be sure the area is clear of bystanders before operating. Stop machine if anyone enters the area.
- Plan your mowing pattern in such a way as to avoid discharging material toward roads, sidewalks, bystanders, vehicles, windows, etc. Do not discharge material against a wall or obstruction. Doing so may cause the discharged material to ricochet back toward the operator.
- Do not mow anything but grasses.
- Stop the blades when crossing dirt, gravel, or paved surfaces.
- Avoid dangerous environments. Do not operate the mower in the rain or in wet or damp grass. To reduce the risk of electric shock, do not expose to water or operate on wet ground.

2.4 MOWING

- For riding mower models, always remain seated while operating machine.
- Do not operate on inclines greater than 15 degrees.
- Mow only in daylight or in good artificial light. Never rush a mowing job.
- Never attempt high-speed maneuvering, especially in crowded, congested areas or on slopes.
- In order to avoid contact with the blade or injury caused by a thrown object, stay in the operating zone behind the handles, and keep children and bystanders at least 100ft (30m) away from the mower while it is in operation. Stop the motor immediately if someone enters the mowing area.
- Look down and behind before and while moving backwards.
- Slow down before turning.

2.5 SERVICING

- Turn off the machine before servicing or removing blade.
- Do not reach under blade guard. Keep hands, feet, and clothing way from rotating blades.
- To reduce personal risk and damage to the machine, never clean with pressure washer.
- Maintain your mower. Keep cutting edges sharp and clean to ensure the best performance and safe operation.

2.6 CHILD SAFETY

Tragic accidents can occur if the operator is not aware of the presence of children. Children are often attracted to the machine and the mowing activity. Never assume that children will remain where you last saw them.

- Never leave machine unattended with key in switch, especially with children present.
- Keep children out of the mowing area and under the watchful care of a responsible adult other than the operator.
- Do not allow children under the age of 14 to operate this mower. Children who are 14 years of age and older must read and understand the operating instructions and safety rules in this manual, and must be trained and supervised by a parent.
- Always disengage deck blade switch and turn key to "OFF" position and remove key.
- Stay alert, and turn the mower off if a child or any other person enters the mowing area.
- Use extreme care when approaching blind corners, doorways, shrubs, trees, or other objects that may obscure

your view of a child who may run into the path of the mower.

- Before and while backing, look behind and down for small children.
- Never carry children on the mower with you, even with the blade(s) shut off. They may fall off and be seriously injured or interfere with safe machine operation. Children who have been given rides in the past may suddenly appear in the mowing area for another ride and be run over or backed over by the machine.

2.7 USE A RAMP

- Use extreme caution when loading and unloading this mower onto a truck or trailer with a ramp.
- Use only a single, full-width ramp. This provides a surface for the mower frame to contact if the unit starts to tip backwards. It also reduces the risk of a wheel going off and the machine tipping over.
- Do not exceed a 15-degree angle between the ramp and the ground or between the ramp and the trailer or truck.
- Become familiar with the mower's controls and confident in its smooth operation before attempting to drive it up or down a ramp.
- Use slow drive mode and drive carefully.
- Avoid any sudden movement of the controls and use only slow, even acceleration.

2.8 TOWING

- Tow only with a machine that has a hitch designed for towing. Do not attach towed equipment except at the hitch point.
- Follow the manufacturer's recommendation for weight limits for towed equipment and towing on slopes.
- Never allow children or others in or on towed equipment.
- On slopes, the weight of the towed equipment may cause loss of traction and loss of control.
- Travel slowly and allow extra distance to stop.

2.9 BATTERY AND CHARGER

- Do not recharge batteries in a confined or unvented area.
- Do not smoke, strike a match, or cause a spark in the vicinity of the battery during charging.
- Store indoors, and do not expose to rainwater. Avoid storing in direct sunshine.
- Do not charge batteries in rain or in wet location.
- When servicing, use only identical replacement parts.
- Only to be used with Greenworks Commercial 82V Batteries. See Parts Manual.
- Electrical maintenance should be performed by trained professionals ONLY.

2.9.1 BATTERY

- Battery-operated mowers and tools do not have to be plugged into an electrical outlet to run; therefore, they are













always in operating condition. Be aware of possible hazards when not using your battery-operated mower or when changing accessories. Following this rule will reduce the risk of electric shock, fire, or serious personal injury.

- Do not place battery-operated machines or tools -- or the batteries themselves -- near fire or heat. This will reduce the risk of explosion and possibly injury.
- Do not crush, drop or damage battery pack. Do not use a battery pack or charger that has been dropped or received a sharp blow. A damaged battery is subject to explosion. Properly dispose of a dropped or damaged battery immediately.
- Batteries can explode in the presence of a source of ignition, like a pilot light. To reduce the risk of serious personal injury, never use any cordless product in the presence of an open flame. An exploded battery can propel debris and chemicals. If exposed, flush with water immediately. Do not charge battery tool in a damp or wet location. Following this rule will reduce the risk of electric shock.
- For best results, your battery-operated machine should be charged in a location where the temperature is more than 0°C (32° F) but less than 45°C (113° F). To reduce the risk of serious personal injury, do not store outside or in vehicles.
- Charge batteries in an open, well-ventilated area away from spark and flames. Unplug charger before connecting or disconnecting battery to/from the charging port. Always wear safety glasses and protective clothing/gear. Use insulated tools.
- Incorrect battery cable routing could cause damage to the mower and battery cables. This can cause sparks, which can cause a battery gas explosion that will result in serious personal injury.
- Do not open or mutilate the battery. Mutilated batteries can release corrosive electrolytes which can cause damage to the eyes or skin. It may be toxic if swallowed.

3 SYMBOLS ON THE PRODUCT

Some of the following symbols may be used on this tool. Please study them and learn their meaning. Proper interpretation of these symbols will allow you to operate the tool better and safer.

Symbol	Name	Explanation
V	Volt	Voltage
A	Amperes	Current
Hz	Hertz	Frequency (cycles per second)
W	Watt	Power
min	Minutes	Time
/min	Per Minute	Revolutions, strokes, surface speed, orbits etc., per minute

Symbol	Name	Explanation
	Direct Current	Type or a characteristic of current
n_0	No Load Speed	Rotational speed, at no load
	Safety Alert	Precautions that involve your safety.
	WARNING --- Wet Conditions	Do not expose the product to rain or moist conditions.
	Read Operator's Manual	To reduce the risk of injury, user must read and understand operator's manual before using this product.
	Eye Protection	Always wear eye protection with side shields marked to comply with ANSI Z87.1 when operating this equipment.
	DANGER --- Keep Hands and Feet Away	To reduce the risk of injury, keep hands and feet away from rotating parts. Do not operate unless discharge cover or grass bag is in its proper place. If damaged, replace immediately.
	DANGER --- Steep Slope Hazard	Use extra caution on slopes. do not mow slopes greater than 15 degrees.
	DANGER --- Thrown Debris	Remove objects that can be thrown by the blade in any direction. Wear safety glasses.
	DANGER --- Keep Bystanders Away	Keep all bystanders at least 100 ft. away.
	Look around	Always look where you are going and be aware of your surroundings.
	Keep children away	Never carry children on the mower with you. Keep children and animals out of the mowing area.
	No Reach	Do not reach hands or feet under mower deck.

4 ENVIRONMENTALLY SAFE BATTERY DISPOSAL



The toxic and corrosive materials below are in the batteries used in this machine: **Lithium-Ion, a toxic material.**

▲ WARNING

Discard all toxic materials in a specified manner to prevent contamination of the environment. Before discarding damaged or worn out Li-ion battery, contact your local waste disposal agency, or the local Environmental Protection Agency for information and specific instructions. Take the batteries to a local recycling and/or disposal center, certified for lithium-ion disposal.

▲ WARNING

If the battery pack cracks or breaks, with or without leaks, do not recharge it and do not use. Discard it and replace with a new battery pack. **DO NOT TRY TO REPAIR IT!** To prevent injury and risk of fire, explosion, or electric shock, and to avoid damage to the environment:

- Cover the terminals of the battery with heavy-duty adhesive tape.
- **DO NOT** try to remove or destroy any of the battery pack components.
- **DO NOT** try to open the battery pack.
- If a leak develops, the released electrolytes are corrosive and toxic. **DO NOT** get the solution in the eyes or on skin, and do not swallow it.
- **DO NOT** put these batteries in your regular household trash.
- **DO NOT** incinerate.
- **DO NOT** put them where they will become part of any waste landfill or municipal solid waste stream.
- Take them to a certified recycling or disposal center.

5 PROPOSITION 65

▲ WARNING

This product contains a chemical known to the state of California to cause cancer, birth defects or other reproductive harm. Some dust created by power sanding, sawing, grinding, drilling, and other construction activities contains chemicals known to cause cancer, birth defects or other reproductive harm. Some examples of these chemicals are:

- Lead from lead-based paints;
- Crystalline silica from bricks and cement and other masonry products;
- Arsenic and chromium from chemically treated lumber.

Your risk of exposure to these chemicals varies depending on how often you do this type of work. To reduce your exposure to these chemicals, work in a well-ventilated area, and work with approved safety equipment, such as dust masks that are specially designed to filter out microscopic particles.

Save these instructions.

6 DESCRIPTION

6.1 PURPOSE

This machine is used for domestic lawn mowing. The cutting blade should be parallel to the ground. All four wheels must touch the ground while mowing.

6.2 OVERVIEW

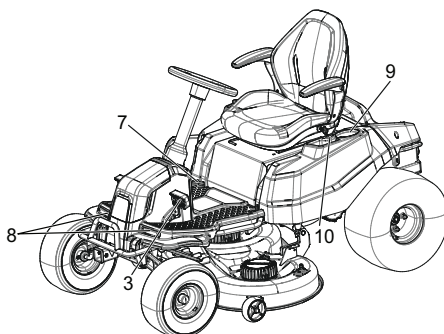
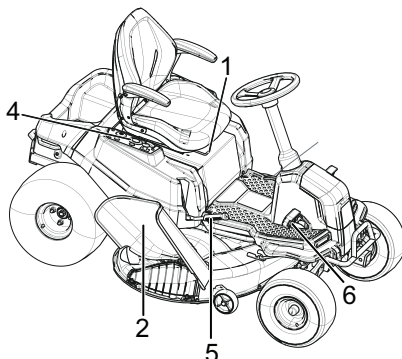

- 1 Seat adjustment lever
- 2 Side discharge chute
- 3 Brake pedal
- 4 Control panel
- 5 Deck height adjustment lever
- 6 Accelerator pedal
- 7 Parking brake bar
- 8 Headlights
- 9 Cup holder
- 10 USB port

6.3 CONTROL PANEL

6.3.1 CONTROL PANEL

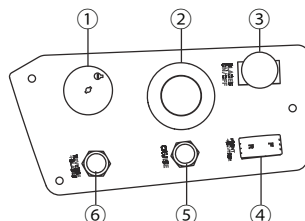

#	Name	Function
1	Power switch with start key	The power switch is used to turn the mower on and off. The start key must be inserted before the switch can be operated.
2	Digital display	This display shows important electrical system information. Refer to the Electrical section for complete information.
3	Blade engage knob	Pull the blade engage knob up to activate the mower's cutting blades. Push the knob down to stop the cutting blades. i NOTE For cutting in reverse, the reverse mode button must also be activated.
4	Direction control button	The direction of movement of the mower is controlled using the direction control switch. Available settings are forward (F) and reverse (R).
5	Cruise control button	The cruise control button allows you to continue forward at a set speed without needing to press the accelerator pedal.
6	Reverse mode button	Press the reverse mode button to allow the mower to cut when maneuvering in the reverse direction. The blades will disengage if mower is operated in reverse without pressing the reverse mode button. i NOTE The blade engage knob must also be pulled up for mowing to occur when maneuvering in reverse.

7 INSTALLATION

⚠ WARNING

Do not use accessories that are not recommended by the manufacturer.

⚠ WARNING

Do not put in the safety key or the battery pack until you finalised the assembly of all the parts.

7.1 UNPACK THE MACHINE

⚠ WARNING

Make sure that you correctly assemble the machine before use.

⚠ WARNING

- If parts of the machine are damaged, do not use the machine.
- If you do not have all the parts, do not operate the machine.
- If parts are damaged or missing, contact the service center.

1. Open the package.
2. Read the documentation provided in the box.
3. Remove all the unassembled parts from the box.
4. Remove the machine from the box.
5. Discard the box and packing material in compliance with local regulations.

7.2 INSTALL THE SEAT

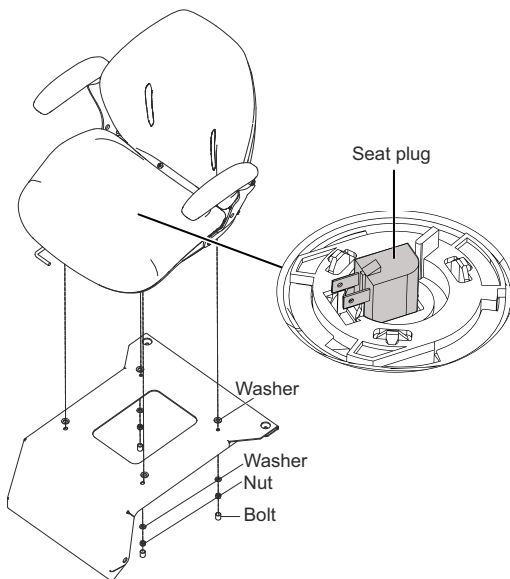

1. Remove four washers from seat mounting brackets.
2. Place the seat assembly over the mounting brackets and align holes as shown.
3. Connect the seat plug to the machine.
4. Install the bolts, washers and nuts and tighten securely.
5. Make sure it is securely seated.

7.3 INSTALL THE STEERING WHEEL

i NOTE

Make sure the slot faces up to the seat.

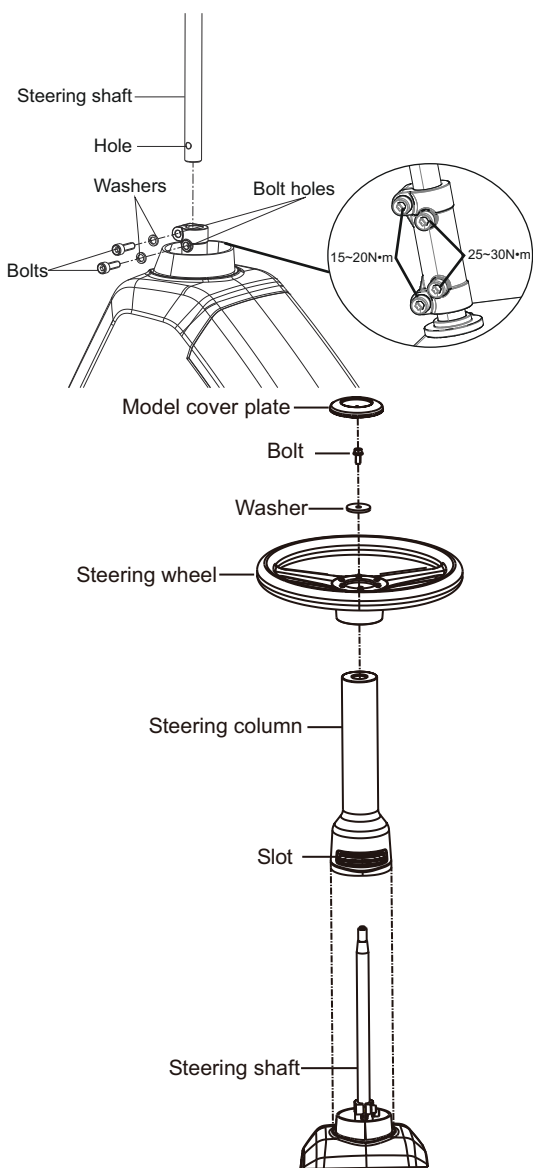

1. Install the steering shaft into the coupler, rotating as needed to align hole in shaft with bolt hole in coupler.
2. Install two bolts and tighten securely.

i NOTE
Torque bolts to the value as shown.

3. Install the steering column. Note the tabs on the bottom of the steering column that fit into the holes in the opening and make sure steering column is securely seated.
4. Make sure the mower's wheel is pointed straight ahead, then install the steering wheel over the steering column with force.
5. Install the bolt and washer; tighten securely.
6. Install the steering wheel cover plate.

7.4 INSTALL THE ACCESSORIES

1. Mulch cover
2. GPS software (sold separately)

i NOTE
The GPS software can provide remote machine locking/unlocking, a machine locate feature, a machine serial number etc...

7.4.1 INSTALL THE MULCH COVER

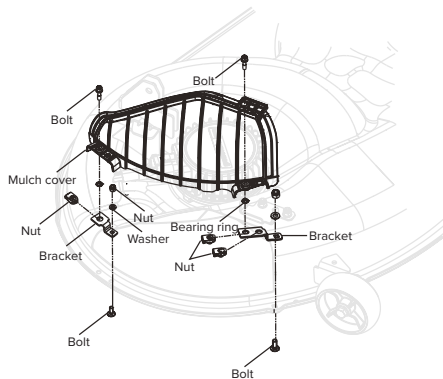

The mower is configured for side discharge when shipped. If mulching is desired:

1. Place the mulch cover on the tab on the mower housing.
2. Align the holes in the mulch cover and the holes in the mower housing.
3. Install and tighten the bolts, screws, fixation clamps and bearing ring as shown.

8 OPERATION

▲ WARNING
Wear eye protection during operation.

8.1 BEFORE OPERATION

8.1.1 ADJUST THE SEAT

Adjust the seat position to ensure you are able to make firm contact with the accelerator and brake pedals before operating the mower.

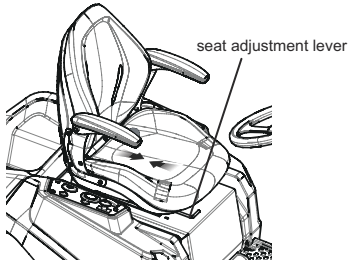

1. Sit down on seat and lift the seat adjustment lever.
2. While holding the lever, slide the seat to the desired position.
3. Release the lever and make sure the seat is locked in position before operating the mower.

▲ WARNING

Be sure the seat is locked into place before operating the mower. A seat that is not secure can cause the operator to shift and lose control of the mower and result in possible death or serious personal injury.

8.1.2 ADJUST THE DECK CUTTING HEIGHT

Before using the mower, raise the deck height to the cutting position best suited for your lawn.

Deck height is adjustable from 1.5-4.5". Deck should be raised while mowing is in progress to avoid stumps, rocks or other obstacle that can be damage mower deck.

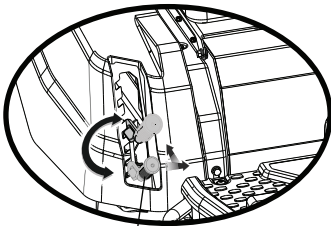

1. Stop the mower and disengage blades.
2. Turn key to OFF position and set the parking brake.
3. To raise the cutting deck, grasp the deck height adjustment lever, push left to disengage from slot, move toward the back of the mower, then push right into slot to secure.

4. To lower the cutting deck, grasp the deck height adjustment lever, push left to disengage from slot, move toward the front of the mower, then push right into slot to secure.

▲ CAUTION

Hold the deck height adjustment lever firmly when setting the deck height and only release when it is secure in the desired slot. Quickly letting go of the lever may create a pinching or pulling hazard to the operator's hand.

8.1.3 INSTALL THE BATTERY PACK

Mower batteries must be charged overnight before first use. To verify mower batteries are fully charged, check the battery level indicator. See the battery manual for more details.

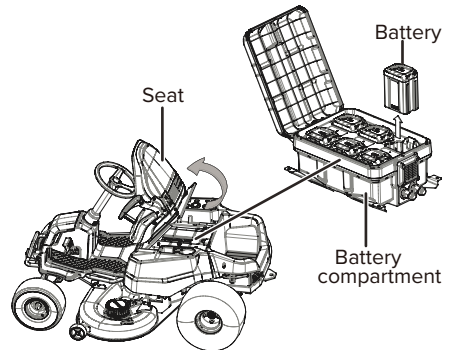

1. Lift the seat panel.
2. Lift the battery compartment cover.
3. Install the battery pack into the battery compartment.

i NOTE

Make sure that you install at least one battery in each column.

3 BATTERIES REQUIRED IN SAME ROW TO OPERATE VEHICLE



8.1.4 BEFORE OPERATING THE MACHINE

- Ensure work area is clear of children, bystanders, and pets.
- Clear the work area of objects that may be thrown by the mower blades.

- Check brake operation.
- Check tire pressure.
- Check for loose fasteners.
- Check to make sure all guards are in place and working properly.
- Clean debris from mower.
- Test safety interlock system.
- Adjust seat to desired position.
- Verify battery charge level.

8.2 OPERATE THE MACHINE

8.2.1 START THE MACHINE

▲ WARNING
Clear the area of bystanders before operating the mower. If anyone enters the mowing area, stop immediately and do not return to mowing until the bystanders leave the area.

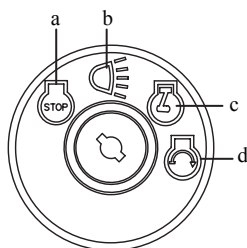

a	Stop/ Off
b	On with Lights
c	Run
d	Start

1. Raise the mower deck to its highest position.
2. Insert start key and turn to ON position (d).

i NOTE
The key will return back to (c) position automatically. Wait for 4s until the display shows normally.

3. Release the parking brake.
4. Place direction control switch in forward (F) position and drive to desired mowing location.

▲ WARNING
Be certain you have correctly set your intended direction of travel with the direction control switch before pressing the accelerator pedal. Failure to do so could result in you driving the mower in an unintended direction, which could cause loss of control or an accident resulting in death, serious personal injury, or property damage.

i NOTE
Turn the headlight on by turning the key to the position (b).

▲ WARNING
Use caution when crossing over gravel paths or driveways. Before crossing, disengage the blades and raise the cutting deck to the highest position to minimize the possibility of ricochet. Drive slowly to avoid loss of traction and control.

i NOTICE
Do not attempt to change the direction of operation while the mower is in motion. Always come to a complete stop before changing the mower direction.

8.2.2 STOP THE MACHINE

1. Stop mower on a flat, level surface.
2. Set the parking brake.
3. Push the PTO switch down to turn blades off.
4. Turn the key to OFF position (a).

8.2.3 SET THE CRUISE CONTROL

Cruise control allows the mower to remain at a constant speed without the operator having to maintain pressure on the accelerator pedal. It should only be used in the forward position on relatively smooth, straight surfaces, and should never be used on slopes or rough terrain.

8.2.3.1 SET THE CRUISE CONTROL

1. While driving the mower forward, press the accelerator pedal until the desired rate of speed is achieved.
2. Press the cruise control button. The light around the button will illuminate to show cruise control is active.
3. Release pressure on the accelerator pedal. Mower speed should remain constant.

8.2.3.2 RELEASE THE CRUISE CONTROL

1. Tap on the accelerator pedal, depress the brake pedal, or press the cruise control button again.

8.2.4 SET THE PARKING BRAKE

1. Fully depress and hold the brake pedal.
2. Push the parking brake lever all the way down until it engage into the slot.
3. Release the brake pedal.

▲ WARNING
Never leave the mower unattended when the motor is running. Verify that the parking brake is set and the key has been removed. Failure to set the parking brake could cause the mower to move, and leaving the key could allow unauthorized use that could result in serious personal injury.

8.2.5 REVERSE MODE OPERATION:

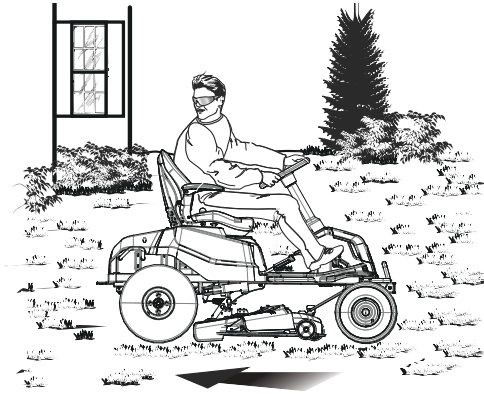

- Depress the brake pedal and bring the mower to a complete stop.
- Push the PTO switch down to turn blades off.
- Place direction control switch in reverse (R) position.
- Raise the blade engage knob, slowly press accelerator pedal, and reverse mow as needed.
- Keep pressing the reverse mode button to activate the blade.

▲ WARNING

Do not mow in reverse unless absolutely necessary. Always look down and behind before and while backing to make sure no children, bystanders, or pets enter the mowing area. Be aware that the reverse mode operation is activated when the reverse mode button is illuminated in green. Remember that a careless fraction of a second is sufficient to inflict death or serious injury.

▲ WARNING

Be especially careful before and when backing with the bagger kit (not provided) installed, as it may limit visibility. Always look closely behind and down for small children, bystanders, and pets and move the mower slowly to prevent back over accidents that can cause death or serious personal injury.

8.2.6 SAFETY INTERLOCK SYSTEM

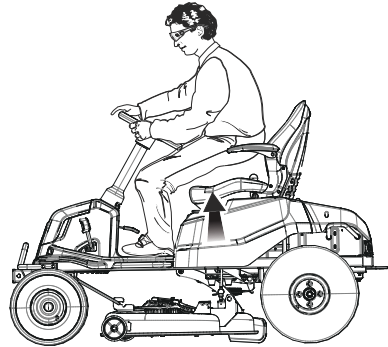

This mower features a Safety Interlock System to protect the operator by shutting off the blades if the operator leaves the seat with the blades running. Test the system before each use to be sure it is working correctly.

1. Make sure direction control switch is in neutral (N) position and blade engage knob is down.
2. Install start key and turn to ON position.
3. Raise the PTO switch to activate blades.
4. Briefly lift off the seat, but do not get off the mower.

The blades should shut off within 5 seconds. If they don't, contact customer service. Do not operate the mower until the safety interlock system has been repaired.

8.2.7 USE THE USB PORT

USB port

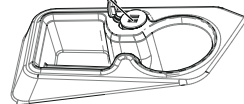

The USB charging port provides charging power of 5 Volts DC at up to 2 amps for your cell phone, MP3 player, or other USB devices. Consult the owner's manual for your device for specific charging requirements.

Connect one end of a USB cable (not provided) to your device and the other end to the USB charging port on the mower, to begin charging your device.

i NOTICE

Attempting to charge devices rated more than 2 amps could damage the USB charging port and/or the mower.

i NOTE

The USB port is only powered when the start key is in the ON position.

▲ WARNING

Never use headphones or any electronic device, such as a smart phone or tablet, while operating the mower. Distracted operation can result in an accident that could result in death or serious personal injury to the operator or a bystander.

8.2.8 OPERATION TIPS

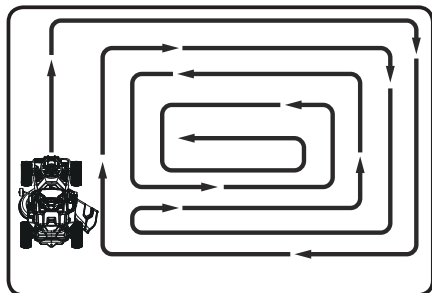

- Keep mower blades sharp.
- Make sure the lawn is clear of stones, sticks, wires, toys, tree nuts, tree branches, and other objects that could damage the lawn mower blades or motor. Do not mow over property stakes or other metal posts. Such objects could damage the blade or be accidentally thrown by the mower in any direction and cause serious personal injury to the operator and others.
- For a healthy lawn, always cut off one-third or less of the total length of the grass.
- When mowing large areas, start by turning to the right so that clippings will discharge away from shrubs, fences, driveways, etc. After one or two rounds, mow in the opposite direction, making left hand turns until finished.
- Mow so that discharged clippings exit in the direction of the lawn area that has already been cut.
- When cutting heavy grass, reduce speed to allow for more effective cutting and a proper discharge of the clippings.
- Do not cut wet grass. It will stick to the underside of the deck and prevent proper bagging or mulching of grass clippings.
- New or thick grass may require a narrower cut or a higher cutting height.
- Keep the mower deck and side discharge chute clean. Remove grass clippings, leaves, dirt, and any other accumulated debris before and after each use. Do not spray with a garden hose to clean.

i NOTE

Always stop mower, allow blades to completely stop, and remove the start key before cleaning underneath the mower.

8.2.9 SLOPE OPERATION



Slopes are a major factor related to loss of control and tip-over accidents, which can result in severe injury or death. Operation on all slopes requires extra caution. If you cannot back up the slope or if you feel uneasy on it, do not mow it.

- Mow up and down slopes, not across.
- Watch for holes, ruts, bumps, rocks, or other hidden objects. Uneven terrain could overturn the machine. Tall grass can hide obstacles.
- Do not mow near drop-offs, ditches or embankments. The machine could suddenly roll over if a wheel goes over the edge or if the edge caves in.
- Choose a low ground speed so you will not have to stop or shift while on a slope.
- Do not mow on wet grass. Tires may lose traction.
- Avoid starting, stopping, or turning on a slope. If the tires lose traction, disengage the blade(s) and proceed slowly straight down the slope.
- Keep all movement on slopes slow and gradual. Do not make sudden changes in speed or direction, which could cause the machine to roll over.
- Use extra care while operating machine with attachments; they can affect the stability of the machine. Do not use on steep slopes.
- If using the optional bagger kit, use extreme caution and operate the mower slowly when operating on slopes, as the bagging kit can change the stability of the mower.
- Always use the brakes when travelling down the slope. Do not attempt to let the mower coast downhill in neutral.

8.2.10 DIGITAL DISPLAY

The function of the digital display, located on the control panel, is to provide electrical system information to the operator. It gives detailed information in the form of pattern, codes and number.

8.2.10. DIGITAL DISPLAY

1

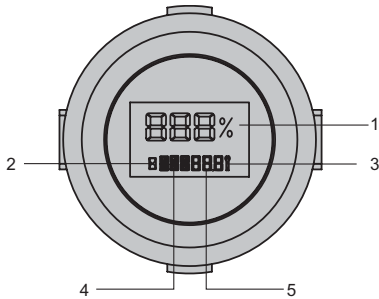

#	Name	Meaning
1		Battery remaining capacity
2		Time signal
3		Controller fault/ battery fault/ motor fault/ vehicle fault
4		Fault position
5		Fault code/ total working hours

8.2.11 FAULTS

The Canbus system will take action to protect the user and machine when it detects an issue. When it acts to turn off the machine or a component, it will indicate that a fault has occurred, and that fault will be shown on the digital display. All electrical faults have a letter code followed by a number. The first letter describes the system that caused the fault according to this chart:

T	Traction Controller
PMU	Battery
MR	Right Blade Controller
ML	Left Blade Controller

9 FAULT CODE

Display	Description	Status code	Beeper	Cause	Solution	
⚙	The machine does not work when powered on.	The cruise control switch is working.	V15	No	The position of switch is not correct.	Check whether the cruise control switch is stuck
		The neutral bypass knob is engaged.		No	The position of switch is not correct.	Depress the parking pedal to park
		You pull up on the PTO switch.		No	The position of switch is not correct.	Press the knife start switch
		The accelerator pedal is depressed.		No	The accelerator pedal is not in the initial position	Put the accelerator pedal in position
⚙	Throttle failure	The connector of the potentiometer is loose.	V18	No	Loose connector.	Contact the service center for help
		Potentiometer failure		No	Potentiometer failure.	Contact the service center for help
N/A	The display is black without showing the fault code.	Abnormal connection of display connector.	N/A	No	Loose connector.	Contact the service center for help
		Display failure.		No	Display failure.	Contact the service center for help
⚙	The drive motor does not work.	The PCBA that controls the drive motor fails.	N/A	No	PCBA failure.	Contact the service center for help
		The 6pin connector between the drive motor and the drive controller is loose.	T15/T21	No	Loose connector.	Contact the service center for help
		The phase wire connection of the motor is loose.	N/A	No	Loose wiring.	Contact the service center for help
		The brake switch fails.	N/A	No	Switch failure.	Contact the service center for help
		Drive battery management module fails.	PMU12	No	PMU failure.	Contact the service center for help
		Drive motor failure	N/A	No	Motor failure.	Contact the service center for help

Display	Description	Status code	Beeper	Cause	Solution	
⚙	The blade motor does not work.	The left cutter controller does not receive the run command	ML25	No	PCBA failure or CAN communication is abnormal	Contact the service center for help
		The right cutter controller does not receive the run command	MR25	No	PCBA failure or CAN communication is abnormal	Contact the service center for help
		The PCBA controlling the left blade motor fails	V12	No	PCBA failure	Contact the service center for help
		The PCBA controlling the right blade motor fails	V13	No	PCBA failure	Contact the service center for help
		The 9pin connector of the left blade motor is loose or the internal pins are loose	ML15/ ML17/ ML22	No	Loose connector	Contact the service center for help
		The 9pin connector of the right blade motor is loose or the internal pins are loose.	MR15/ MR17/ MR22	No	Loose connector	Contact the service center for help
		The battery management module status is abnormal.	PMU12 / PMU21 / PMU22 / PMU31 / PMU33	No	PMU failure	Contact the service center for help
		The left blade power management module sleeps.	V12/V2 2	No	PMU long-term standby and enters hibernation protection	Restart the machine.
		The right blade power management module sleeps.	V13/V2 3	No	PMU long-term standby and enters hibernation protection	Restart the machine.
		The battery pack model in the battery compartment is incorrect.	PMU13 / PMU23 / PMU33	No	Battery pack is not applicable	Replace with the specified battery pack
		The left blade motor fails.	N/A	No	Motor failure	Contact the service center for help
The right blade motor fails.	N/A	No	Motor failure	Contact the service center for help		

Display	Description	Status code	Beeper	Cause	Solution	
🔑	The battery compartment does not work.	The power management module sleeps.	V22/V23	No	PMU long-term standby and enter hibernation protection	Restart the machine.
		The connector of the key switch is loose and falls off.	NA	No	Loose connector	Contact the service center for help
		The power management module fails.	PMU22 / PMU32	No	PMU failure	Contact the service center for help
		The battery pack voltage is low.	PMU22 / PMU32	No	The battery pack capacity is too low	Replace with a fully charged battery.
		The battery pack model in the battery compartment is incorrect.	PMU23 / PMU33	No	Battery pack is not applicable	Replace with a fully charged battery.
N/A	The beeper alarms.	The operator leaves the seat.	N/A	Yes	Out of position alarm	Turn off the machine if you leave the machine for a long time.
		The connector between the wire harness and the seat switch is loose.	N/A		Loose connector	Contact the service center for help
		The 4pin connector between the display and the vehicle wire harness is loose.	N/A		Loose connector	Contact the service center for help

10 MAINTENANCE

Regular maintenance is the best prevention for costly downtime or expensive, premature repair. The following pages contain suggested maintenance information and schedules which the operator should follow on a routine basis. For more detailed information, refer to the website for your unit. Remain alert for unusual noises, as they could be signaling a problem. Visually inspect the machine for any abnormal wear or damage.

10.1 TIRES

It is important for level mowing that all tires have the correct amount of air pressure. The recommended pressure are:

NOTE

Tire pressure should only be measured or adjusted when tires are cold.

Drive wheels	12±2 psi
Front caster wheels	8±2 psi

NOTE

Inspect the tires daily. Replace immediately if damaged.

WARNING

Check the tire pressure carefully while inflating. Too much air in the tire could cause the tire to burst, causing serious personal injury.

10.2 MOWER BLADE MAINTENANCE

Check the mower blades daily. They are the key to power efficiency and well-groomed turf. Keep them sharp -- a dull blade will tear rather than cut the grass, leaving a brown ragged top on the grass within a few hours. A dull blade also requires more power. Replace any blade that is bent, cracked or broken.

WARNING

Never attempt to straighten a bent blade by heating, or weld a cracked or broken blade as the blade may break and cause serious injury. Replace worn or damaged blades.

▲ WARNING

Never work with blades while key is in the ignition switch. Turn key to "OFF" position, remove key from switch and disconnect battery cables by pulling inward on RED battery quick disconnect handle in battery box compartment. Block up mower when you must work under it. Wear gloves when handling blades. Always check for blade damage if mower strikes a rock, branch or other foreign objects!

▲ DANGER

The blade adapter will come off when the blade cap screw is removed. Touch-up sharpening can be done with a file. Check the blades for balance following grinding. A commercial balancing tool is available through most hardware supply stores, or balancing can be done by placing the blade on an inverted line punch or 1/2" bolt. Blade should not lean or tilt. While spinning the blade slowly, it should not wobble. If blade is out of balance, true it up before reinstalling. Lay the blade on a flat surface and check for distortion. Replace any distorted blade.

▲ WARNING

- The blade sail (curved part) must be pointing upward toward the inside of the deck to ensure proper cutting.
- When mounting blades, rotate them after installation to ensure blade tips do not touch each other or sides of the mower.
- Failure to correctly torque the bolt may result in the loss of the blade, which can cause serious injury.
- Mower blades are sharp and can cut. Wear gloves and use extra caution when servicing them.

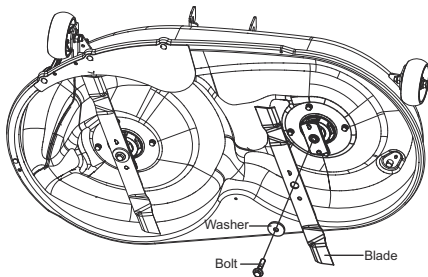
10.2.1 REPLACE THE BLADE

1. Make sure direction control switch is in neutral (N) position and blade engage knob is down.
2. Stop the motor, remove the start key, and set the parking brake.
3. Raise the height of the cutting deck to its highest position to allow access to blades.

i NOTE

If necessary, raise the mower by placing on a lift or using a jack and jack stands, or remove the cutting deck as described in the previous section to gain access to the blades.

▲ WARNING

If raising the mower to access the blades, make sure the mower is properly secured and the parking brake is set before proceeding. Failure to properly secure the mower could cause it to fall, resulting in death or possible serious personal injury.

4. Wedge a block of wood between the blade and mower deck to prevent the blade from turning.
5. Loosen the blade nut by turning it counterclockwise (as viewed from bottom of mower) using a 15 mm wrench or socket (not provided).
6. Remove the blade nut, spacer, blade insulator, and blade.
7. Place the new blade on the shaft against the corresponding blade posts. Ensure blade is properly seated with shaft going through center blade hole and the two blade posts inserted into their respective holes on the blade. Make sure it is installed with the curved ends pointing up toward the mower deck and not down toward the ground. When seated properly, the blade should be flat against the blade posts.
8. Replace the blade insulator and spacer, making sure the flat sides on each piece align and the straight sides of the opening on the spacer are aligned with the straight sides of the blade shaft.

i NOTE

Make certain all parts are replaced in the exact order in which they were removed.

9. Thread the blade nut on the shaft and finger tighten.
10. Torque the blade nut down clockwise using a torque wrench (not provided) to ensure the bolt is properly tightened. The recommended torque for the blade nut is 600-650 in. lbs.

▲ WARNING

Ensure blade is properly seated and the blade nut is tightened to the torque specifications above. Failure to properly attach the blade could cause it to come loose and result in possible serious personal injury.

11. Repeat with second blade, if needed.

10.3 REPLACE THE HEADLIGHT

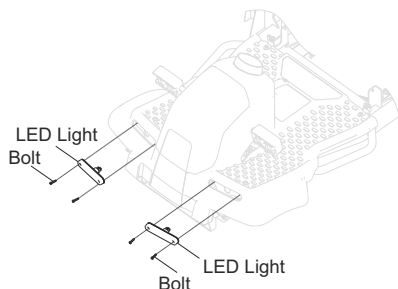

1. Park the mower on a level surface and set the parking brake.
2. Stop the motor and remove the start key.
3. Remove and set aside the hex head screw and flat washer holding the mower floor panel in place.
4. Lift floor panel slightly to access the two hex head screws and flat washers securing the headlight in place. Remove screws and washers and set aside.
5. Unplug the old headlight and discard.
6. Plug in new headlight and reinstall washers and screws. Tighten securely.
7. Lower floor panel and reinstall washer and screw to secure.

10.4 LUBRICATION

Please add oil before operation.

Oil type	SAE85W-90
Oil capacity	130 ml

Contact your Greenworks dealer to replace the lubrication.

i NOTE

Replace the gearbox oil every 200 hours' operation.

10.5 TORQUE VALUES

▲ WARNING

Particular attention must be given to tightening the drive wheel lug nuts and blade spindle bolts. Failure to correctly torque these items may result in the loss of a wheel or blade, which can cause serious damage or personal injury.

Torque values are given below:

Part	Ft.-lbs.	Nm
Wheel (lug) nuts	89	120
Blade spindle bolt	66	90

Lug nuts only -It is recommended that these be checked after the first 2 hours of operation, initially, every 100 hours and following removal for repair or replacement.

For all other torques refer to the various mower parts manuals for standard torque chart.

10.6 BATTERY PACK MAINTENANCE

Your Greenworks Commercial mower is powered by a battery pack which, when maintained properly, will provide years of useful life. For proper care, adhere to the following instructions:

- Always charge batteries after each use.
- Whenever a battery pack is fully discharged and turned off, it is best to recharge the battery as soon as possible. Over-discharge of the battery pack means the battery life will be shortened and the battery may become permanently damaged. There is no need to fully charge; it will be beneficial even if you only charge the battery pack for 5-10 minutes. It is best to recharge it within 24 hours.
- Check that battery cables are securely tightened to batteries each time you service the battery.
- Keep grass, dirt and debris from collecting near battery terminals and in battery area.
- Charge batteries indoors in a well-ventilated and dry location away from sparks or flames. Never expose charger to rain, vapor or liquid.
- Charge only lithium batteries provided by Greenworks Commercial.
- Do not touch uninsulated portion of charger (terminal pins) or of output connector.
- Do not use with defective cords and wires. Replace defective cords and wires immediately.
- For long-term storage, please make sure the storage temperature is -4°F - 113°F within one month, and 32°F - 95°F between two and 12 months.
- The working environment of the battery pack is 14°F - 113°F. Battery pack can be used a -5°F - 131°F for discharge, and 32°F - 107°F for charge.

10.7 SERVICE

i IMPORTANT

Wait for all movement to stop before adjusting, cleaning or repairing. Repairs or maintenance requiring power should be performed by trained maintenance personnel only. Read and observe safety warnings in front of manual.

i IMPORTANT

Repairs or maintenance requiring power should be performed by trained maintenance personnel only.

- Park the mower on level ground. Make sure that you set the park brake, and that the deck blade switch is in "OFF" position. Raise deck, rotate key to "OFF" position, remove key from switch and disconnect battery cables by

pulling inward on RED battery quick disconnect handle in battery box compartment.

- Any maintenance operation that requires the removal of safety covers must be performed by a trained service technician.
- Before working on or under the deck, make certain ignition switch is "OFF" and key is removed and deck blade switch cannot be accidentally started and disconnect battery cables by pulling inward on RED battery quick disconnect handle in battery box compartment.
- Use a stick or similar instrument to clean under the mower, making sure that no part of the body -- especially arms and hands -- is under mower.
- Keep your machine clean and remove any deposits of trash and clippings.
- Keep battery compartment, deck and operator's station clean of accumulated trash, grass clippings, and other debris.
- Clean battery compartment, drive motor compartment, mower deck, seat, etc., of all dirt and debris. To clean, use only compressed air. DO NOT use water, solvents, hard cleaners or abrasives.
- Always wear adequate eye protection when servicing the batteries or when grinding mower blades and removing accumulated debris. Never attempt to make any adjustments or repairs to the mower's drive system, mower deck or any attachment while the traction drive system is running. Repairs or maintenance requiring power should be performed by trained maintenance personnel only.
- Never work under the machine or attachment unless it is safely supported with jack stands. Make certain machine is secure when it is raised and placed on the jack stands.
- The jack stands should not allow the machine to move when the traction drive system is running and the drive wheels are rotating. Use only certified jack stands. Use only appropriate jack stands, with a minimum weight rating of 2000 pounds (907.2 kg) to block the unit up. Use in pairs only. Follow the instructions supplied with the vehicle stands.
- Do not touch hot parts of machine.
- Keep nuts and bolts tight, especially the blade attachment bolts. Keep equipment in good working condition.
- Never tamper with safety devices. Check their proper operation regularly.
- Turn the key to the "OFF" position before unlogging the discharge chute.
- Never clear the discharge chute with the machine running. Turn the key to the "OFF" position and be sure the blades have stopped before cleaning. Use a stick to clear a plugged discharge area. Never use your hand!
- Stop unit and allow blades to stop before unlogging chute. Grass collection system components are subject to wear, damage and deterioration, which could expose moving parts or allow objects to be thrown. Frequently check components and replace with manufacturer's recommended parts, when necessary.

- Exercise caution when working under the deck as the mower blades are extremely sharp. Wear gloves and use extra caution when servicing them.
- Use only genuine Greenworks Commercial Mower parts to ensure that original standards are maintained.
- Always disconnect batteries when transporting unit. Keep unit free of grass clippings, leaves and other debris.

11 TRANSPORTATION AND STORAGE

11.1 TRANSPORTATION

▲ WARNING

Use extra care when loading or unloading the machine into a trailer. Press the low speed drive button and carefully move the drive levers as needed to control the speed. Always back onto the trailer when loading. When loading or unloading the mower, do not exceed the maximum recommended operation angle of 15°. Failure to follow these instructions can result in loss of control and result in death, serious personal injury, or property damage.

▲ WARNING

Use care when loading or unloading the mower onto a trailer. Ensure the cutting deck is raised to the highest position so that it is not caught on the ramp. The wheels on the mower can go off the ramp or trailer, causing the mower to pivot or tip over, and result in a crush hazard that can cause death or serious personal injury.

1. Park the mower on a level surface.
2. Raise the cutting deck to the highest position.
3. Position and secure ramp to the trailer according to manufacturer's instructions.

i NOTE

We recommend you use one full width loading ramp that is at least 1 ft. wider than the mower to minimize the risk of the mower's wheels going off the side of the ramp.

4. Slowly back the mower onto the ramp and into the trailer.
5. Lower mower deck completely.
6. Set the parking brake.
7. Turn off mower and remove key.
8. Secure the mower as needed using straps or cables to prevent movement during transport.

▲ WARNING

To avoid accidental starting or movement that could result in serious personal injury, always remove the start key and set the parking brake when transporting the mower.

12 CLEANING AND STORAGE

12.1 CLEAN THE MACHINE

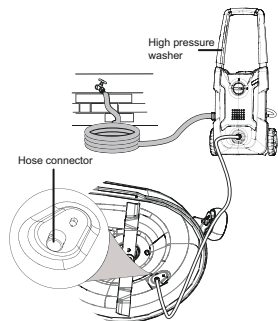

- Briefly drive the mower and check all systems and components to ensure they are functioning correctly.

- Remove any build-up of grass and leaves on or around the motor cover (do not use water).
- Occasionally wipe the mower clean with a dry cloth.
- If debris builds up on the underside of the mower during use, stop the motor, turn off the machine, and scrape it clean using an appropriate tool.
- To clean the blade, connect a high pressure washer to the hose connector under the blade deck. Turn on the blade while you clean the blade.

12.2 STORE THE MACHINE

The following steps should be taken in order to prepare the machine for storage.

- Clean the machine as described in the previous section.
- Inspect the blade and replace it or sharpen it, if required (refer to the Maintenance section).
- Do not store the machine next to corrosive materials, such as fertilizer or rock salt.
- Keep the machine out of the reach of children.
- Do not cover the machine with a solid plastic sheet. Plastic coverings trap moisture around the machine, which causes rust and corrosion.
- Check thoroughly for any worn or damaged parts that need replacing and order them from your dealer.
- Thoroughly lubricate machine, according to lubrication instructions.
- Fully charge and service the batteries.
- Do not deflate tires.
- The machine should be stored in a well-ventilated, clean and dry place.

12.3 PREPARE FOR USE AFTER STORAGE

The following steps should be taken before using the mower after it has been stored:

- Fully charge the batteries.
- Check tire pressure and inflate as needed.

13 TROUBLESHOOTING

Problem	Cause	Solution
When you press the accelerator, the machine does not move.	<ol style="list-style-type: none"> 1. There is no battery pack in the battery compartment that controls the drive function or the battery packs are not Globe designed. 2. The battery pack is out of power. 3. You engage the park brake. 4. There is no person sitting on the seat or the seat switch is not connected. 5. The accelerate pedal, or the blade button, or the cruise control button, or the brake is not in the initial position when the machine powered on. 6. The discharge system of the drive battery compartment is in the sleep mode. 	<ol style="list-style-type: none"> 1. Make sure at least one Greenwoks designed battery pack is inserted in the battery compartment that controls the drive function. Make sure the battery pack has power. 2. Make sure at least one green light on the battery pack is on. 3. Make sure you fully disengage the park brake, so the wheels can rotate freely. 4. Make sure the operator is sitting on the seat, if not, the beeper will alarm. 5. Return the switches to the initial position. If the machine still fails to work, contact the service center for help. 6. Restart the machine.
Sudden breakdown during driving.	<ol style="list-style-type: none"> 1. The battery is out of power. 2. The seat switch is disconnected on rugged or bumpy roads. 3. The accelerator fails. 4. The vehicle controller fails. 	<ol style="list-style-type: none"> 1. Make sure at least one Greenwoks designed battery pack is inserted in the battery compartment that controls the drive function. Make sure the battery pack has power. 2. Restart the machine to check if the machine works normally. 3. Contact a technical people for help.
The blade fails to run when you pull up the PTO switch.	<ol style="list-style-type: none"> 1. There is no battery inserted that controls the left or right blade function. 2. The battery compartment that controls the blade is out of power. 3. The seat switch is not connected. 4. The PTO switch is not in the OFF position when the machine is powered on. 5. The blade motor is blocked or other functional protection. 6. The discharge system of the left or right blade battery compartment is in the sleep state. 	<ol style="list-style-type: none"> 1. Make sure at least one Greenwoks designed battery pack is inserted in the battery compartment that controls the left or right blade. Make sure the battery pack has power. 2. Make sure at least one green light on the battery pack is on. 3. Make sure the operator is sitting on the seat, if not, the beeper will alarm. 4. Push down on the PTO switch, restart the machine. 5. Cut the grass in low blade speed when you power on the machine, set the blade speed to high position once the machine cuts normally. Check if the connection between the blade and motor is without grass or foreign objects to ensure the blade rotates smoothly. 6. Restart the machine.

Problem	Cause	Solution
The blade stops running during the mowing process.	<ol style="list-style-type: none"> 1. The blade motor is overheated. 2. The deck is full of grass and garbage. 3. The blade motor is overloaded. 4. The battery pack temperature is too high. 5. The battery is undervoltage. 6. The blade is hit by a foreign object, causing the blade to stop suddenly for protection. 	<ol style="list-style-type: none"> 1. Do not use the machine too much, power off the machine for 5min. Raise the deck height or reduce the driving speed to protect the blade. 2. Clean the deck to ensure that the blade rotation is normal. 3. Push down on the PTO switch; restart the machine. Raise the deck height or reduce the drive speed to protect the blade. 4. The battery pack stops working once it is over-temperature. wait until the battery pack cools down. Make sure at least one battery pack is inserted for each function. 5. The battery pack that controls the blade system is under voltage. Charge the battery immediately. 6. Push down on the PTO switch and restart the machine.
The beeper alarms.	<ol style="list-style-type: none"> 1. The person leaves the seat when the vehicle is powered on. 2. The display shows abnormal communication. 	<ol style="list-style-type: none"> 1. Turn off the machine if you leave the machine for a long time. 2. Check if the connection of the display communication is OK. If the connection is OK, but the display is still black, contact a service center for help.
The machine cuts the grass unevenly.	<ol style="list-style-type: none"> 1. The blade is dull. 2. The blade is bent. 3. 3. The deck is uneven. 	<ol style="list-style-type: none"> 1. Grind the blade according to the manual. 2. Replace the bent blade, replace the blade according to the instructions in the manual, and wear protective equipment. 3. Adjust the cutting deck according to the instructions in the manual to ensure the left and right deck height are even.
The actual cut height does not match the cut height you set.	<ol style="list-style-type: none"> 1. The bolt of the deck is loose. 2. The deck is severely worn or damaged. 	<ol style="list-style-type: none"> 1. Adjust the cutting deck bolt,make sure the deck is not loose. Please balance the deck level after each adjustment. 2. Replace with a new cutting deck.
The machine cuts the grass abnormally.	<ol style="list-style-type: none"> 1. The grass is too wet. 2. The grass amount you set is too much. 	<ol style="list-style-type: none"> 1. Please check the grass before working. If the grass is too wet, please wait until the grass gets drier. 2. If the grass is too intensive and high, raise the deck height, and avoid cutting intensive grass.
The machine vibrates too much.	<ol style="list-style-type: none"> 1. The blade is loose. 2. The blade is bent. 3. The deck is uneven. 4. The deck is loose. 5. The blade cuts too much grass more than the amount you set. 	<ol style="list-style-type: none"> 1. Grind the blade according to the manual. 2. Replace the bent blade, replace the blade according to the instructions in the manual, and wear protective equipment. 3. Adjust the cutting deck according to the instructions in the manual to ensure the left and right deck height are even. 4. Tighten the fixing bolts of the deck. 5. If the grass is too intensive and high, please raise the cutting deck and try to avoid cutting intensive grass.

Problem	Cause	Solution
There is grass or debris on the ground after mowing.	<ol style="list-style-type: none"> 1. The blade cuts too much grass more than the amount you set. 2. The grass is too wet. 3. You drive too fast. 4. The blade speed is too low. 	<ol style="list-style-type: none"> 1. If the grass is too dense and high, please raise the cutting deck. If the grass height exceeds 6 inch, please cut the area repeatedly. Try to avoid cutting intensive grass. 2. Please check the grass before working. If the grass is too wet, please wait until the grass gets drier. 3. Reduce the drive speed. 4. Turn the blade speed to high position.
The cutting time is short.	Heavy grass can short the running time of the lawn mower.	Raise the cutting deck and reduce the blade speed to extend the running time.
The machine fails to start after cleaning.	Improper cleaning, water enters the battery compartment or the key switch fails.	<ol style="list-style-type: none"> 1. When cleaning the machine, please clean it according to the instructions. 2. If the vehicle is accidentally exposed to rain, please put the vehicle in a dry place for 12 hours or dry it before use.
The mower is blocked.	The deck is full of weeds and garbage.	Please clean the machine correctly according to the instructions after each use.
The machine moves on the slope even if you engage the neutral bypass knob.	<ol style="list-style-type: none"> 1. Tire wear is too serious. 2. The neutral bypass knob is damaged or severely worn out. 	Contact a service center to replace the tire or neutral bypass knob.
The steering wheel does not turn smoothly.	<ol style="list-style-type: none"> 1. Check whether there is rigidity stuck in the gear and rack transmission. 2. Lack of lubrication oil, add lubrication oil. 3. The steering ball head and other parts are damaged and deformed. 	<ol style="list-style-type: none"> 1. Clean up the debris and add lubrication oil. 2. Replace the damaged parts. 3. Adjust the gear space. 4. Contact a service center for help.
Drive axle failure.	<ol style="list-style-type: none"> 1. Oil leakage. 2. The wheel hub heats up. 3. Abnormal sound. 	Contact a service center for help.

14 TECHNICAL DATA

Model No.	RLV42M60	RLV42M80	RLV42M82
Voltage	60 V	80 V	82 V
Gross vehicle weight (lbs)	456	456	456
Length	74.4"	74.4"	74.4"
Height	43.8"	43.8"	43.8"
Width (with discharge)	52.5"	52.5"	52.5"
Deck width	42"	42"	42"
Forward speed (mph)	8 MAX	8 MAX	8 MAX
Reverse speed (mph)	2.9 MAX	2.9 MAX	2.9 MAX

Model No.	RLV42M60	RLV42M80	RLV42M82
Cutting height range	1.5-4.5"	1.5-4.5"	1.5-4.5"
Maximum working capacity (acre)	2	2	2
Bucket capacity (kg)	200	200	200
Battery model	60BA08	BAB734	GL600BT
Charger model	60DPC10A	CAB812	82DPC8A

15 WARRANTY

Greenworks hereby warrants this product, to the original purchaser with proof of purchase, for a period of four (4) years or 200 hours of use (whichever comes first) against defects in materials, parts or workmanship. Greenworks, at its own discretion, will repair or replace any and all parts found

to be defective, through normal use, free of charge to the customer. This warranty is valid only for units which have been used for personal use that have not been hired or rented for industrial/commercial use, and that have been maintained in accordance with the instructions in the owners' manual supplied with the product from new.

15.1 ITEMS NOT COVERED BY WARRANTY:

1. Any that have been transferred to a new owner. This warranty only applies to the original purchaser from an authorized Greenworks retailer or dealer. This warranty is nontransferable.
2. Any part that has become inoperative due to misuse, rental use, commercial use, abuse, neglect, accident, improper maintenance, product modification, unauthorized repair or alteration; or
3. If item has not been operated and/or maintained in accordance with the owner's manual; or
4. Normal wear.
5. Routine maintenance parts or service include, but are not limited to: lubricants, mower seat wear, blade sharpening, wheels, tirs, anti-scalp wheels, blades as well as any optional accessories or attachments.
6. Normal deterioration of the exterior finish due to use or exposure.
7. Damage or failure resulting from, but not solely: immersion in water or other liquids, accidents, misuse, neglect or lack of proper installation, and proper maintenance and storage.
8. An item that has not been registered on an authorized Greenworks website (see REGISTRATION info with QR code or product page info for proper product registration).

15.2 HELPLINE:

Warranty service is available by calling our toll-free helpline, at 1-888-909-6757.

15.3 TRANSPORTATION CHARGES:

Transportation charges for the movement of any power equipment unit or attachment are the responsibility of the purchaser. It is the purchaser's responsibility to pay transportation chares for any part submitted for replacement under this warranty unless such return is requested in writing by Greenworks.

USA address:

Greenworks Tools

P.O. Box 1238

Mooresville, NC 28115

Canadian address:

Greenworks Tools Canada Inc.

P.O. Box 93095, Newmarket,
Ontario

L3Y 8K3

16 GREENWORKS PRODUCT REGISTRATION:

NAME:			
ADDRESS:			
CITY :	STATE :	ZIP CODE :	COUNTRY :
HOME PHONE:		MOBILE PHONE:	
PURCHASE DATE:		PURCHASED FROM:	

17 SERIAL NUMBER(S)

Please list Serial Number(s) below along with Model Information:

DESCRIPTION	MODEL #	PART #	SERIAL #	DATE PURCHASED