

Wall Panel

Reed

Drown out distraction

Drown out distraction, enjoy the view. Reed's graceful panels create soft, undulating textures that break the acoustic mold. Create different panoramic effects based on pattern widths, or dynamically mix sizes (colors and textures too). This design speaks louder than words, with acoustic performance that makes any space sing.



Image by Imperfect*

How To Specify

Key Information

Reed can be a single pattern across a continuous span, or mix and match patterns, color, and texture. Consider these questions as you design your layout.

If shop drawings are required for your project, please follow steps 1 - 7.

Quick Ship

If you're looking to expedite your project, this product is available as Turf Quick Ship!

Using Quick Ship, our standard lead time for shop drawings is eliminated allowing the project to move directly into production.

Please note, installation and seaming drawings are not included in this process.

Turf recommends an additional 10-15% additional panels to cover overage / attic stock.

Type & Color Mix

Type & Color mix panels are available upon request, and are not available as an option for Quick Ship. See details on pages 5-6 for more information.

1

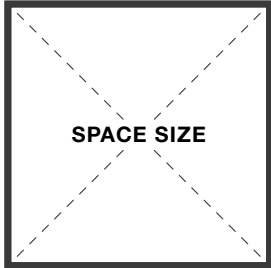

What are the dimensions of your space?

2

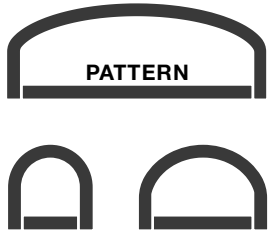

What pattern fits your design?

PAGE 3

3

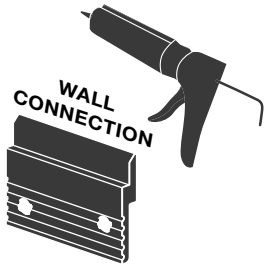

How will Reed mount to the wall, z-clip by Turf or construction adhesive by others?

PAGE 3

4

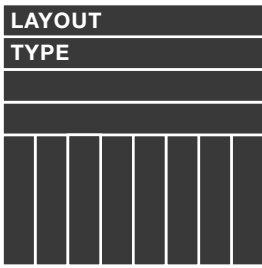

Does your layout change directions?

PAGE 4

5

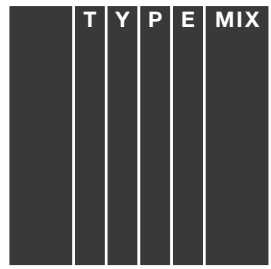

Does your layout use a single pattern or mix multiple patterns?

PAGE 6

6

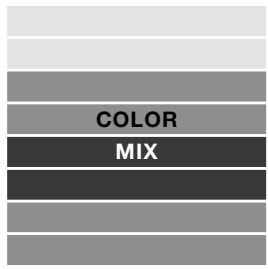

Does your layout use a single color or mix multiple colors?

PAGE 7

7

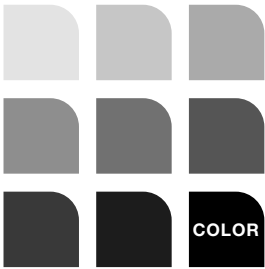

What is the color or texture?

PAGE 10-12

QUICK SHIP



- Do you need the 2", 3" or 6" pattern?
- What panel sizes do you need?
Standard panel width is 12" or 24"
Panel length is between 10"-120"
- Z-clip connection by Turf, or construction adhesive by others?
- What color are the panels?

Dimensions

Standard Panel Widths	12"W, 24"W
Standard Patterns	2"W, 3"W, 6"W
	Reed can be specified with more than one profile type per panel. See our Type Mix page for more details.
2" Pattern Depth	2"D
3", 6" Pattern Depth	2.25"D
Variable Length	10"L Min - 120"L Max

Connection Options

Standard Connection	Z-Clip
Connection By Others	Construction adhesive

Color

9mm Palette	Reed can be specified in any of our 9mm felt colors or textures.
Color Match	Have another color in mind? Our UV printing process can match almost any hue.
Multi-color Layout	Interested in a multi-color layout? Our Color Mix page can show you options and details.

2" PATTERN

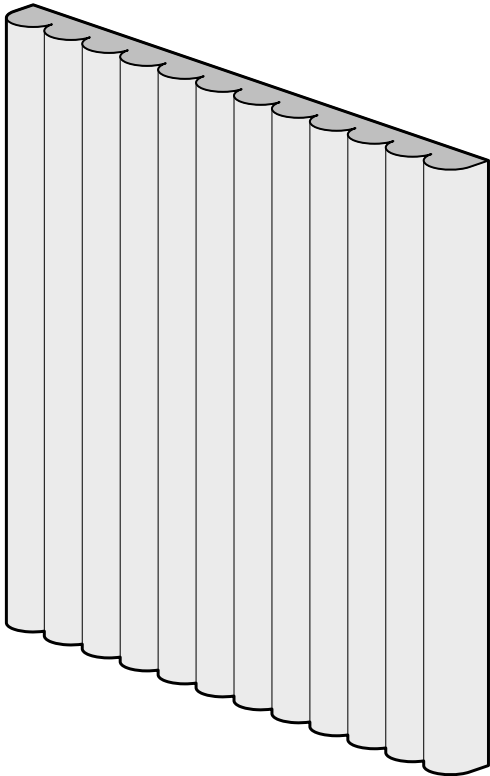

3" PATTERN

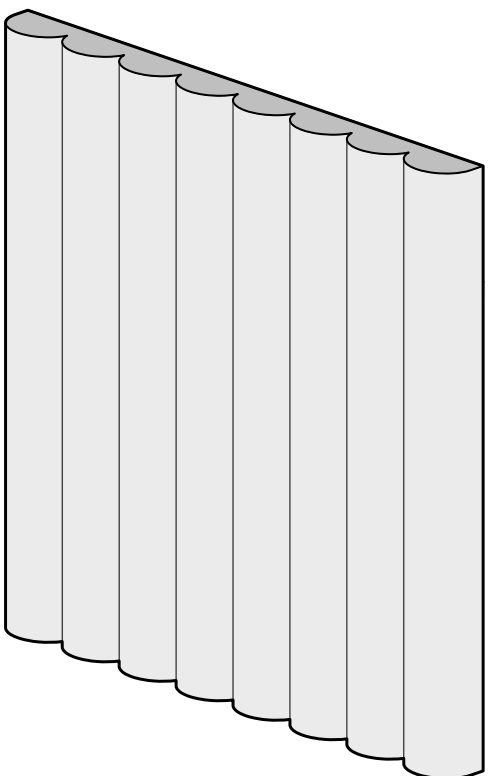

6" PATTERN

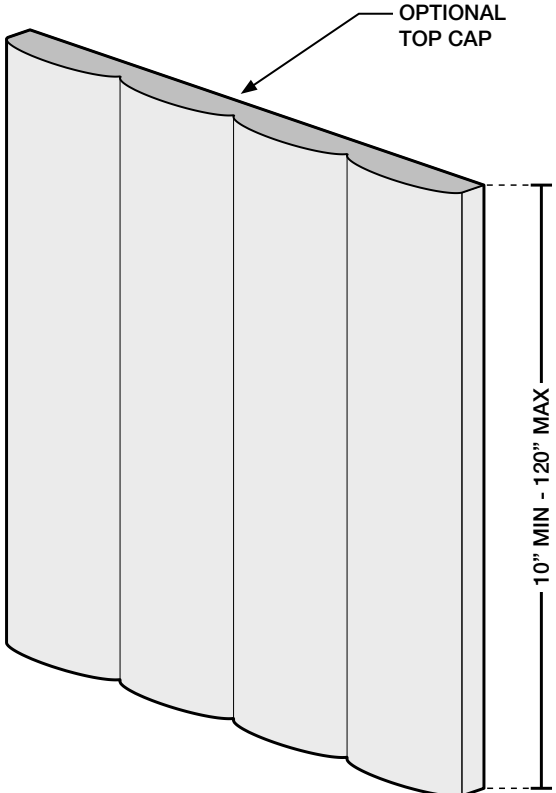

PANEL PLANS

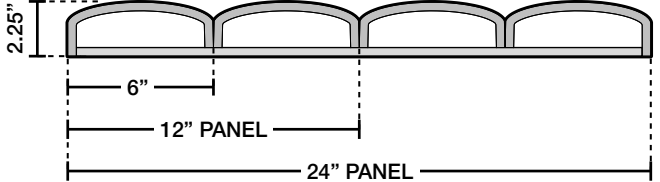
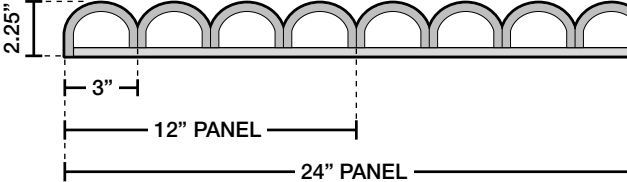
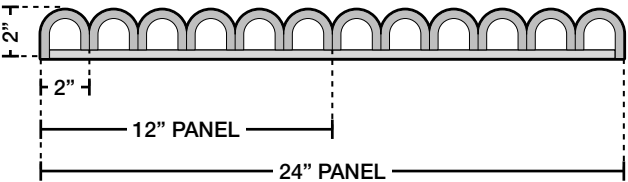

ALL DIMENSIONS NOMINAL UNLESS NOTED OTHERWISE



Typical Layout Options

Vertical

A vertical layout—with panels running top to bottom—is classic and commonly used. This layout offers an elegant, understated look.

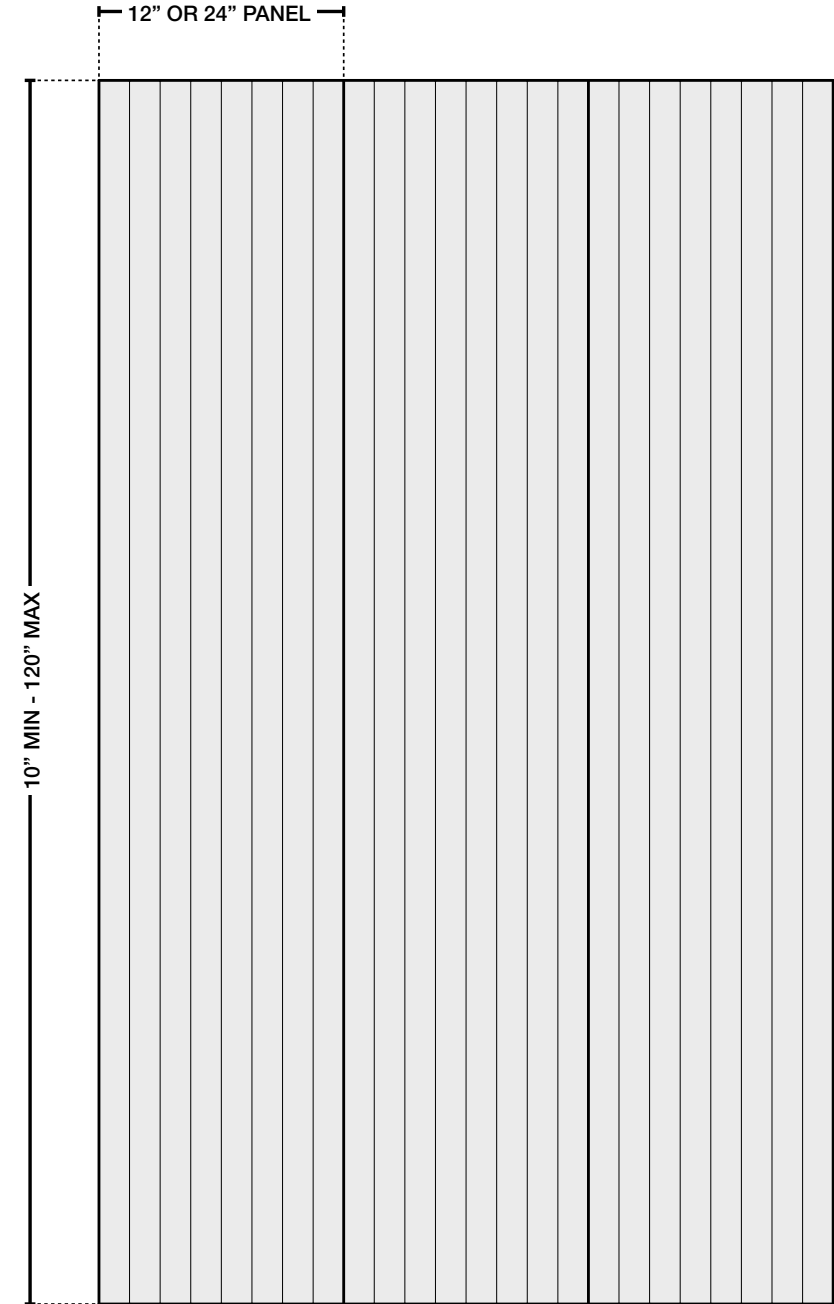

Horizontal

A horizontal layout—with panels running side to side—is simple twist. This layout also offers an elegant, understated look.

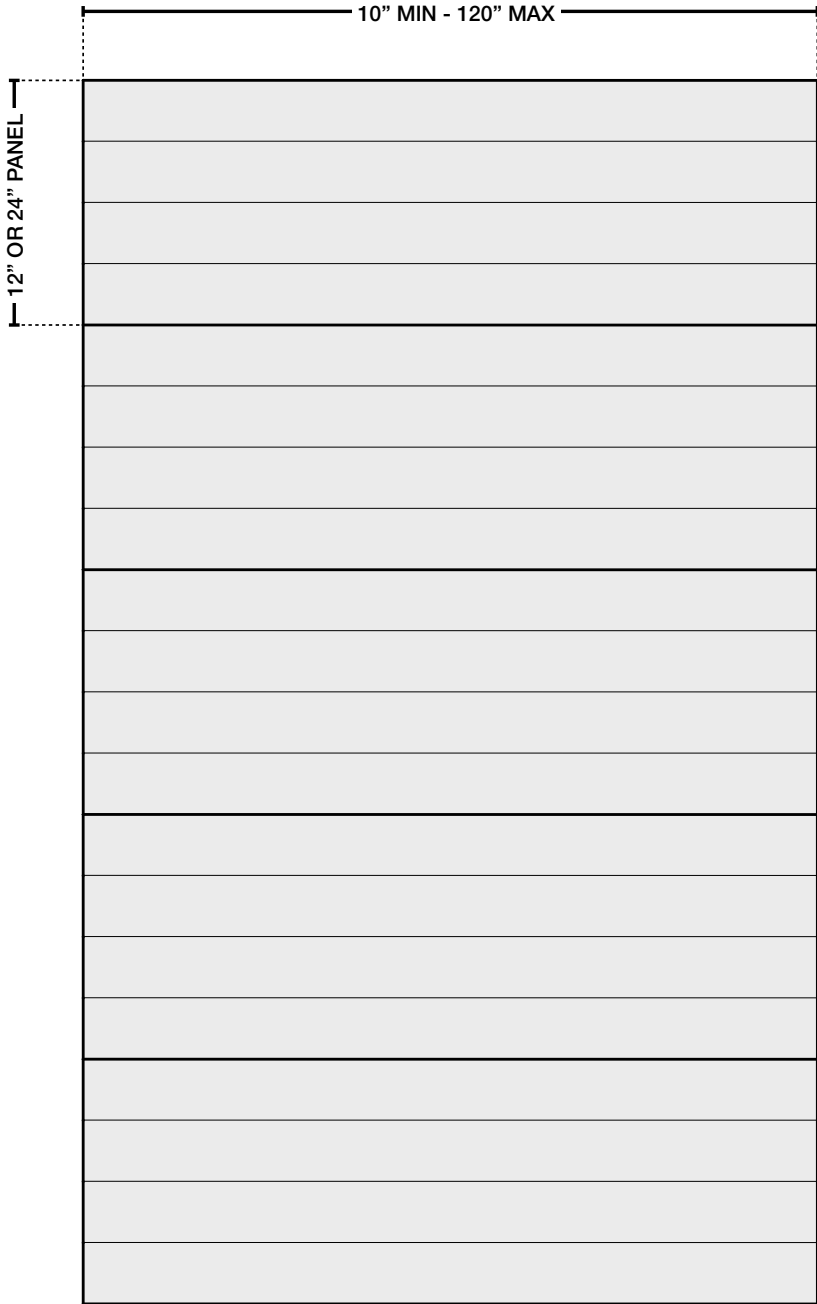

Crosshatch

A crosshatch layout—mixing the direction of panels—creates a dynamic textural effect. This layout offers additional visual interest.

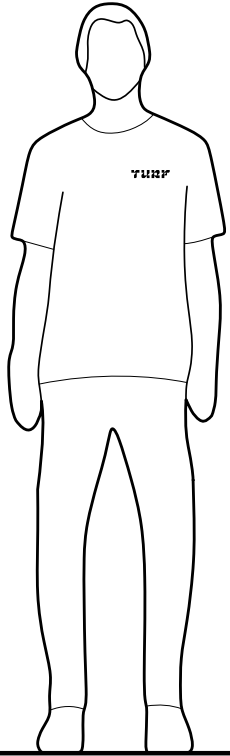
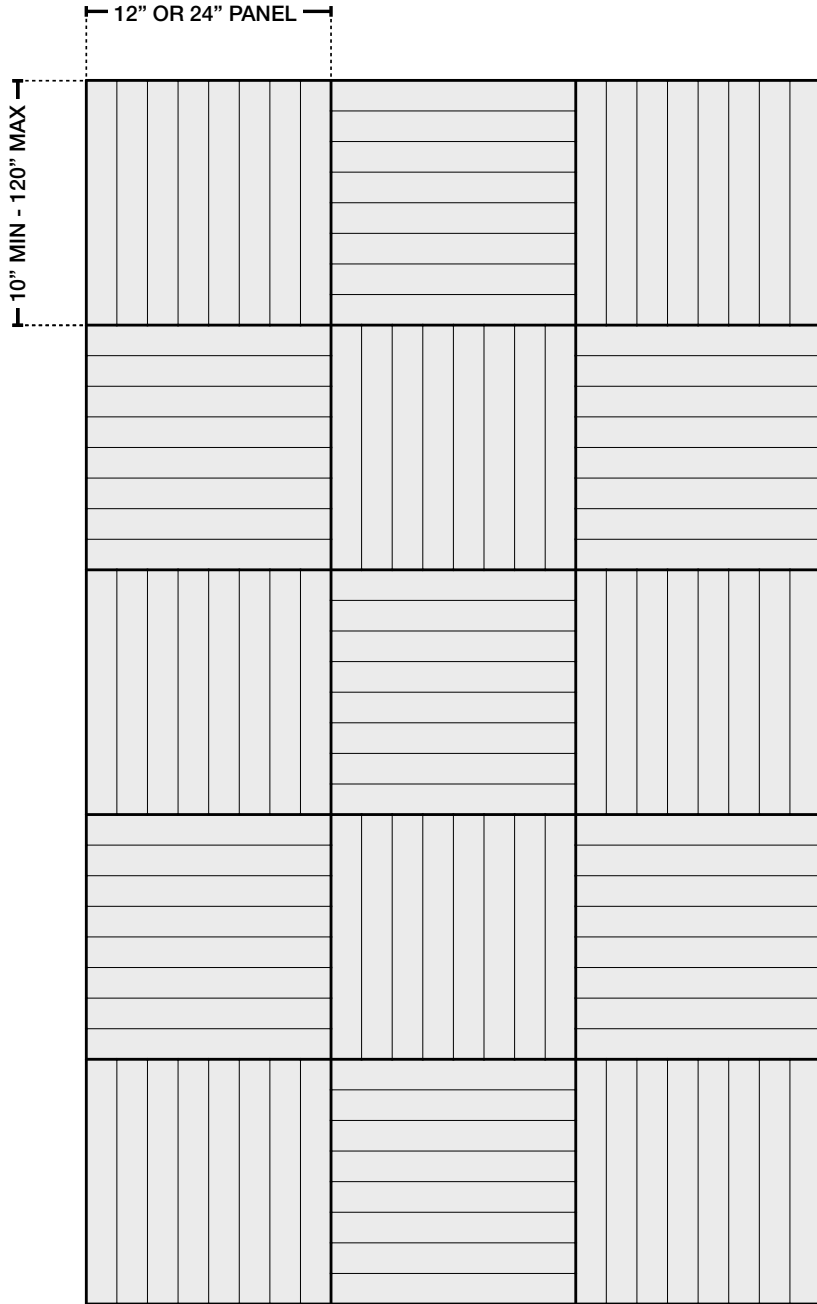

ALL LAYOUT OPTIONS ARE COMPATIBLE WITH ANY REED PATTERN



Layout Considerations

Clearance

1" clearance at the top of panels is factored into all Reed layouts by our design team.

This clearance allows installers to lift z-clips up-and-over during the installation process.

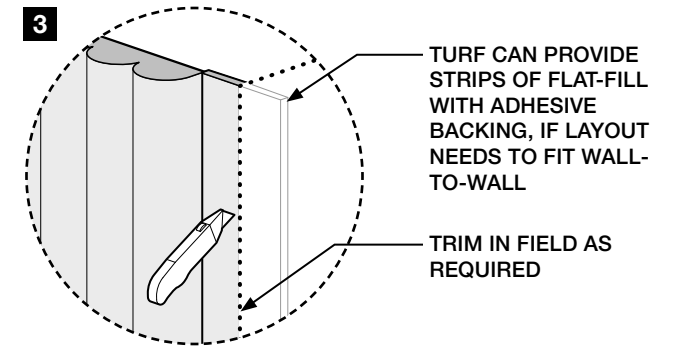
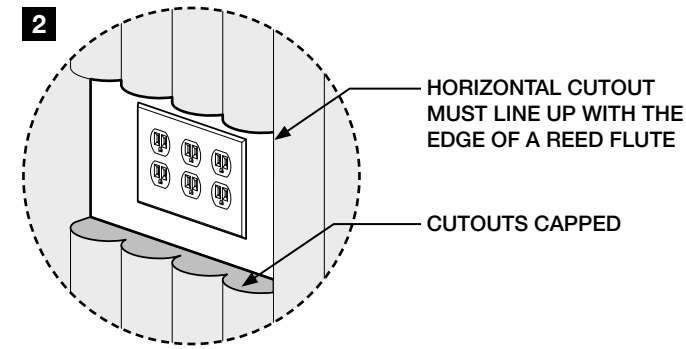
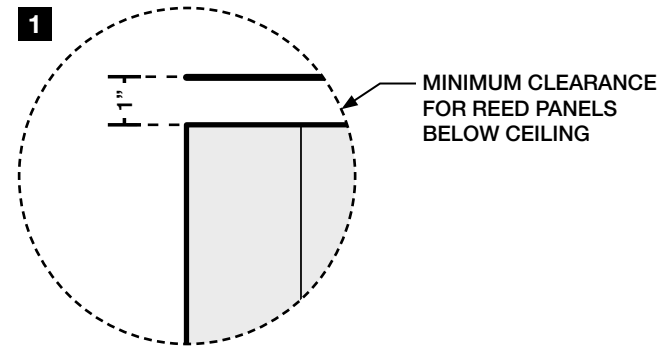

Cutouts

Using verified field dimensions, Turf's design team can provide custom cutouts for Reed panels.

Cutout customization must happen ahead of the Record Set issuance process—panels cannot be trimmed on site.

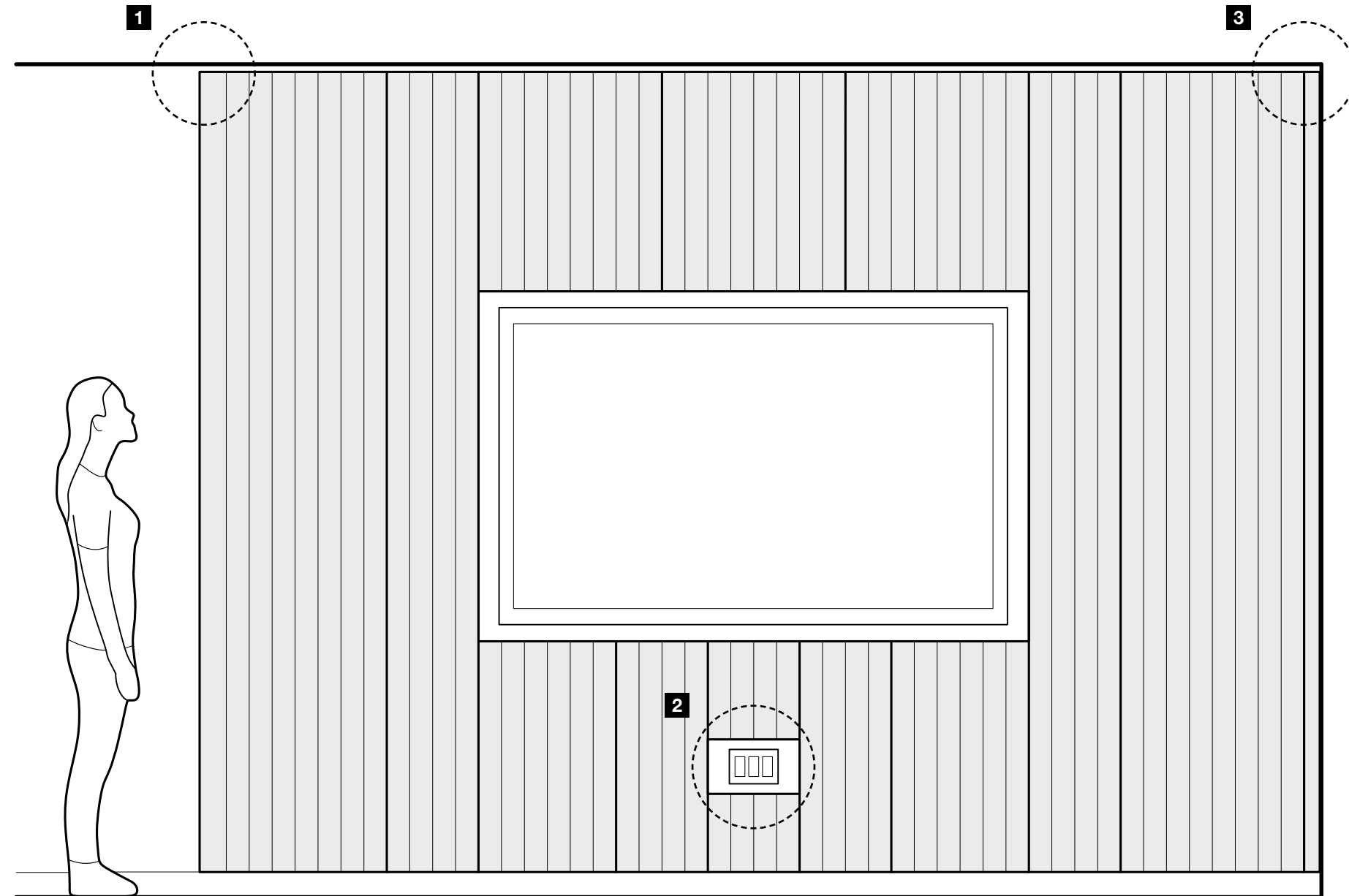

Wall-To-Wall Layout

Turf can provide additional, trimmable flat-fill with adhesive backing to help fit panels for wall-to-wall layouts.

The 9mm felt backing will match the color of the Reed layout.

2" PATTERN - CUSTOM CUTOUT ELEVATION

Type Mix

Combine

See how different profiles can work together to create unique textures.

Patterns

Mixed Patterns

Turf offers a variety of pre-configured patterns to choose from.

Custom Patterns

Interested in a custom pattern? Reach out to our design team with your idea.

Please note, Reed panels can only be specified at 12" or 24" widths. While specifying a custom type mix layout, be mindful of profile widths.

TYPE MIX #1

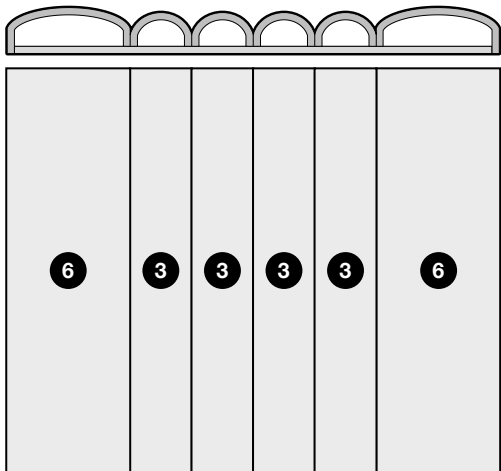

TYPE MIX #2

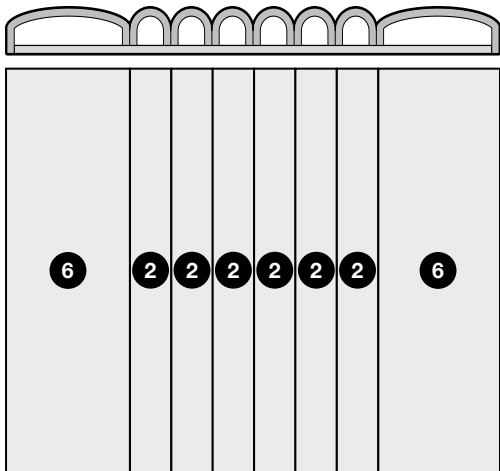

TYPE MIX #3

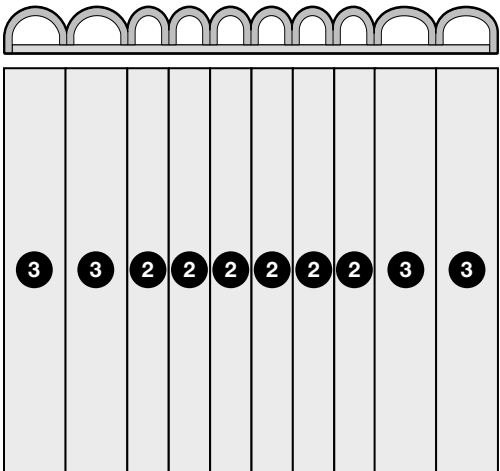

TYPE MIX #4

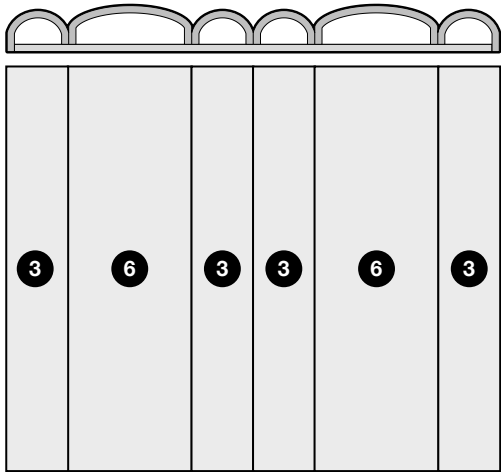

TYPE MIX #5

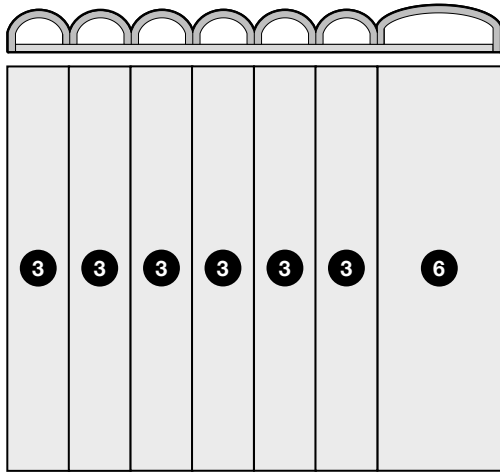

TYPE MIX #6

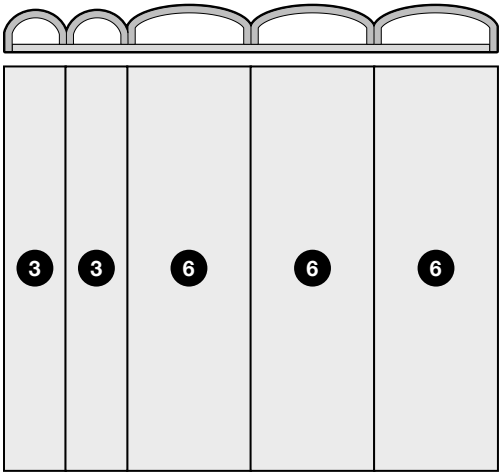

Color Mix

Combine

See how different colors can complement each other — explore Turf’s full palette.

The top cap color will mirror the color of each flute below.

Patterns

Mixed Patterns

Turf offers a variety of pre-configured patterns to choose from.

Custom Patterns

Interested in a custom pattern? Reach out to our design team with your idea.

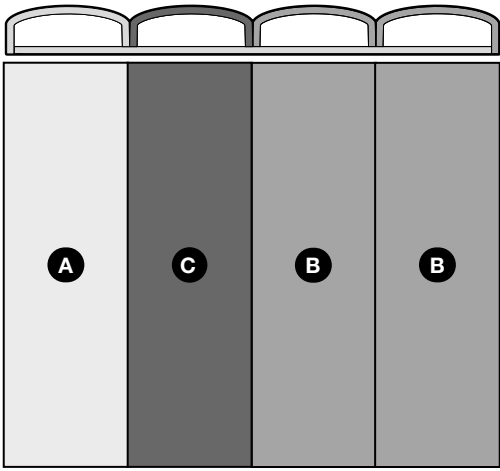
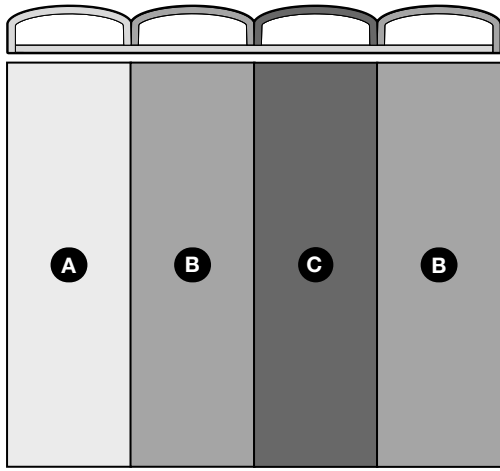
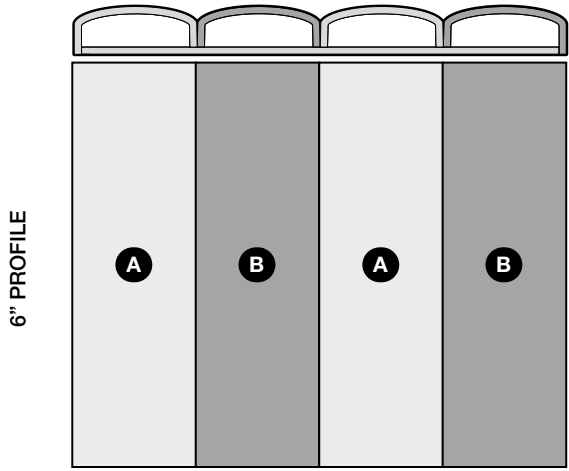
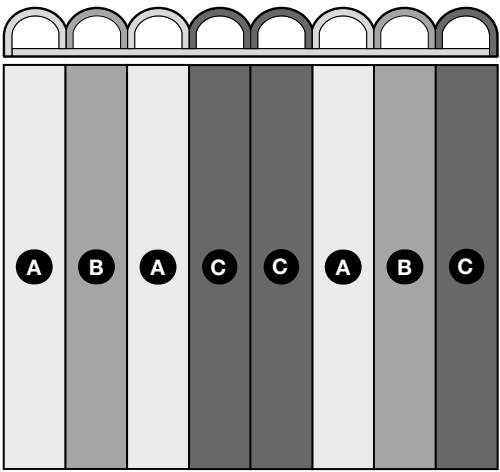
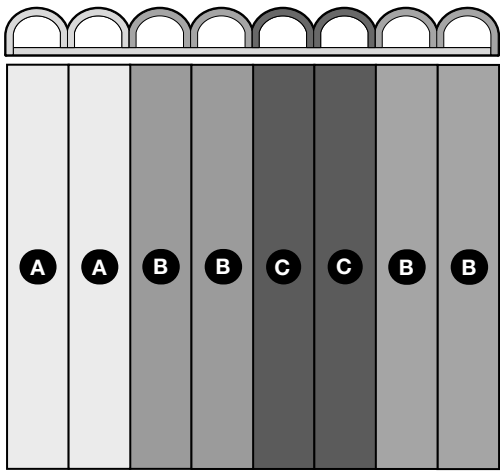
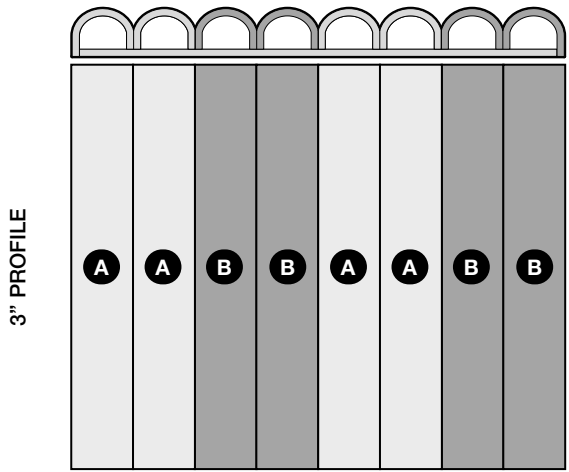
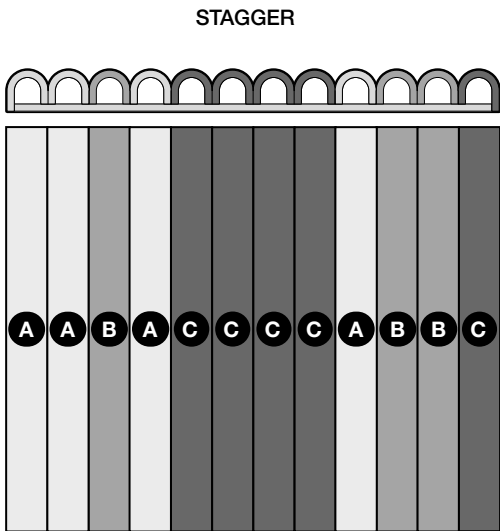
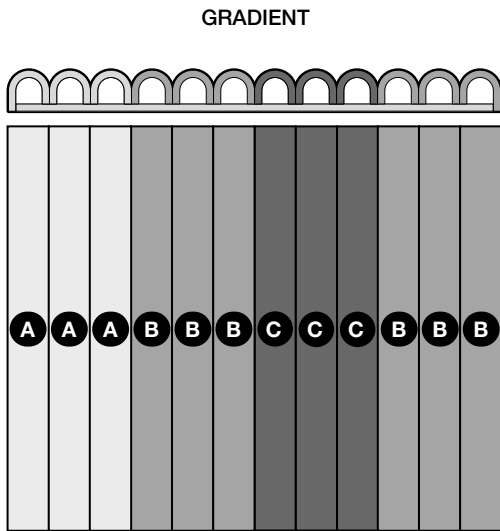
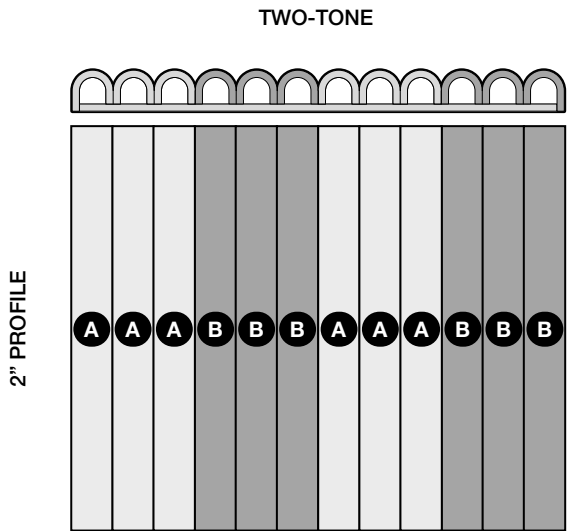

Installation

Reed is designed to be quick and easy to install.

If you're using a standard z-clip connection, Turf installs 2" z-clips on the back of each Reed panel with additional runs of z-clips for mounting use by the installer.

Reed can also be requested without any additional connection hardware. Turf recommends standard construction adhesive by others be used during installation.

The installation instructions included are written for a typical z-clip installation.

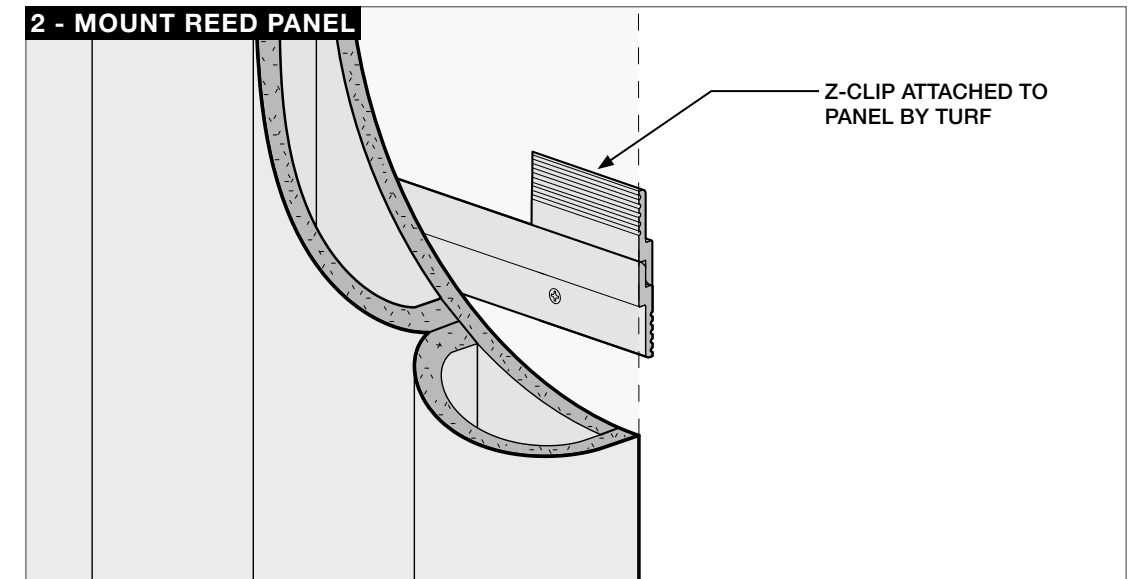
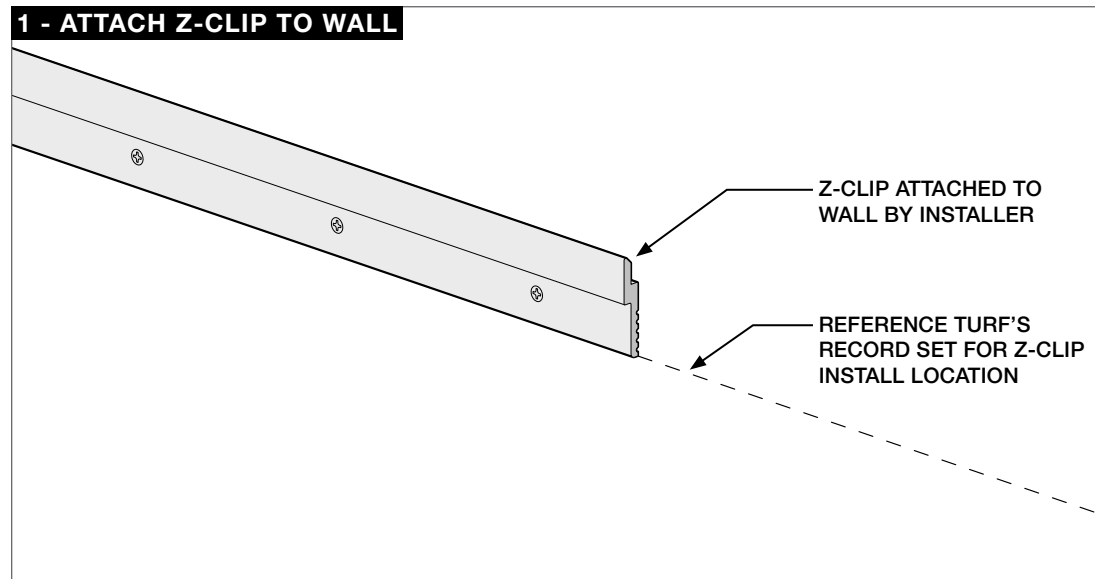

Connection Options

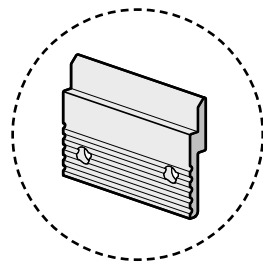

Z-CLIP

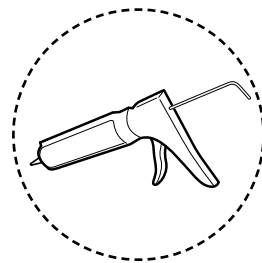

CONSTRUCTION ADHESIVE BY OTHERS

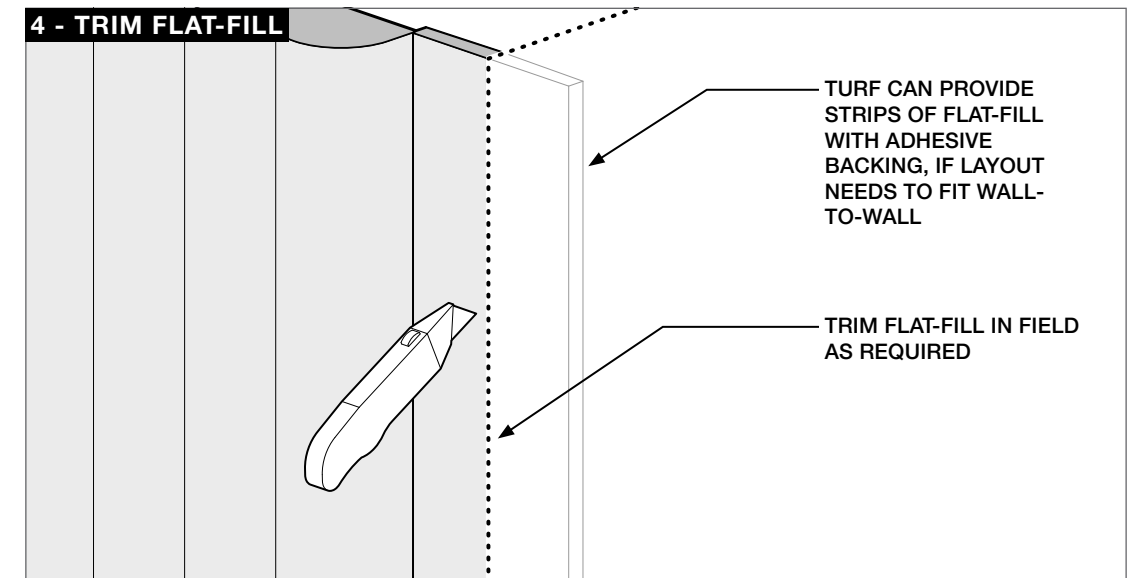
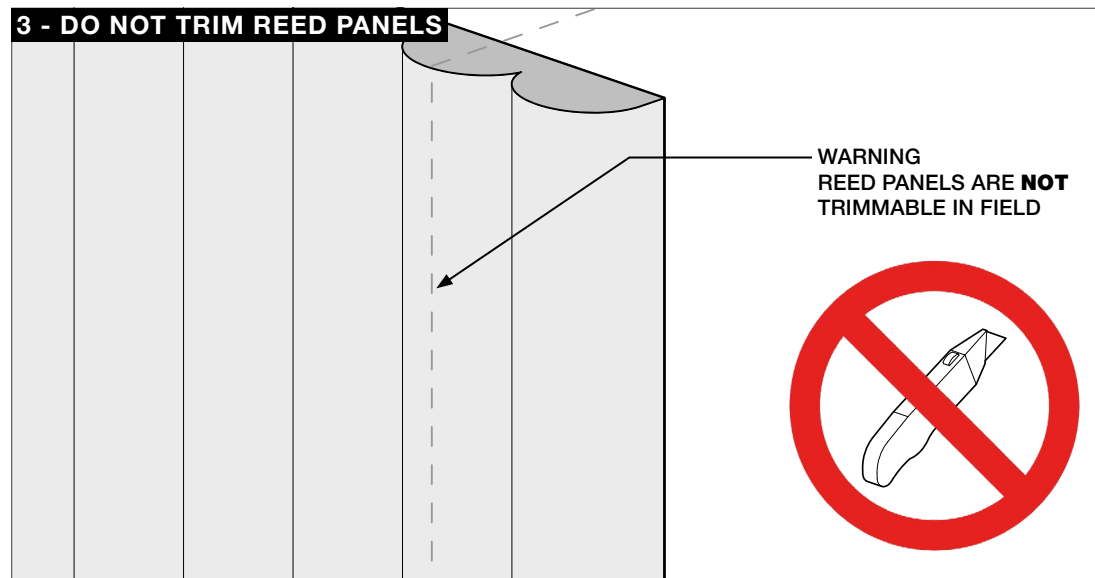

Tech

Acoustics	ASTM C423-17: Type A Mounting
Fire Rating	ASTM E-84 – Class A
VOC	ASTM D5116 Compliant

Details

Lead Time	Check the Turf website for current lead times.
Warranty	Five (5) years
Maintenance	Vacuum to remove any particulate matter and air-borne debris or dust. Compressed air can be used to dust the material in difficult to reach areas for large assemblies. Contact us for more information relative to spot cleaning.
Weight	Turf products cannot support the weight of any other items in field.

Acoustic Rating

2" Profile	NRC = 0.9
3" Profile	NRC = 0.9
6" Profile	NRC = 0.8

The specimen mounting was laid directly against the test surface. Perimeter edges were sealed with metal framing.

Certifications

Declare.



Image by Imperfect*



Image by Imperfect*

9mm Colors

Introducing Hues, our new 9mm color palette designed for the senses.

The 9mm PET felt board is used as our primary construction material. Select one of our coordinating neutrals to blend in, or go for a contrasting element with one of our hues.

The process used to create PET felt often results in a heathered effect where multiple tones are present. Slight variations in color should be expected when using this sustainable material.

Felt Thickness
9mm +/-0.5 mm

Monitors and printers vary. Please request a material sample to verify felt colors.



10 TOPO GREEN



12 GRASSHOPPER



11 CELADON

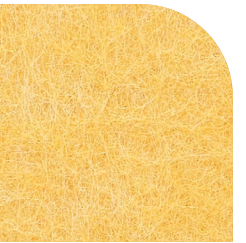

63 SAFFLOWER

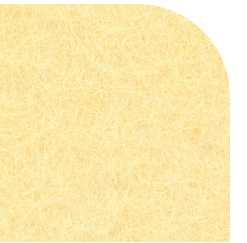

64 PLANTAIN

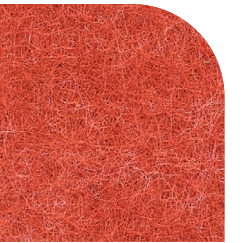

43 ORANGE CRUSH

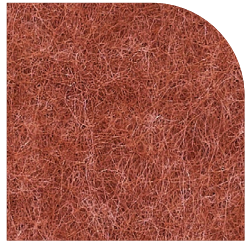

18 ULTISOL



17 BLUSH

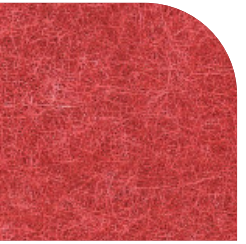

23 RED

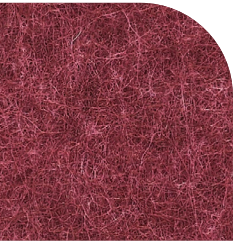

15 MERLOT

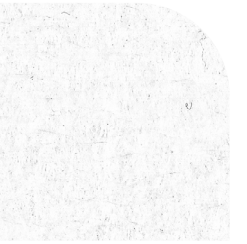

50 IVORY



33 LUMINARY



83 HOLLAND OATS



82 BARLEY



34 TONAL TAUPE



35 BARK

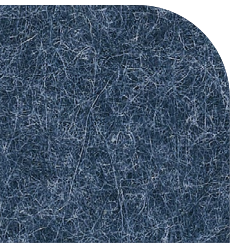

28 INDIGO

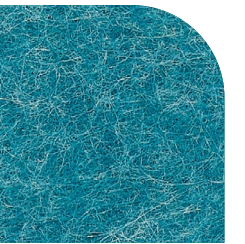

30 CYAN

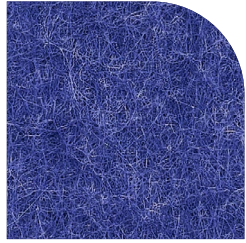

24 ROYAL BLUE

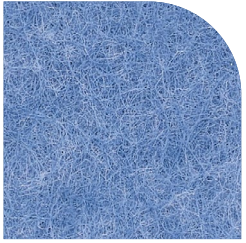

31 AZURE

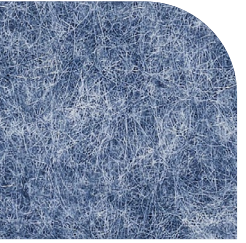

27 JEAN JACKET

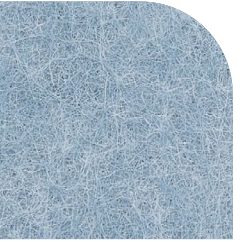

26 FADED DENIM

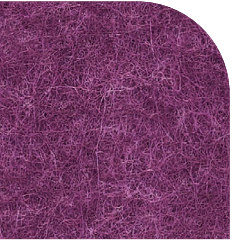

40 MAGENTA

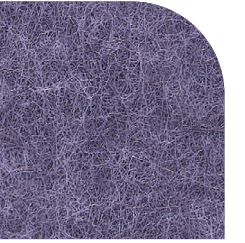

41 DRIED LAVENDER

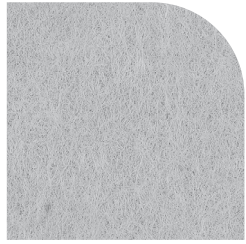

66 PEWTER



05 WHITE

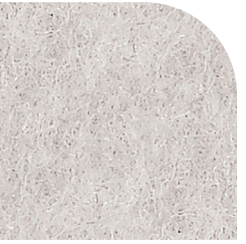

01 CREAM

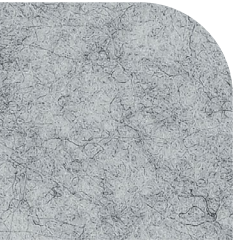

04 LIGHT GREY



98 STORM

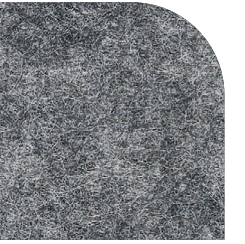

09 DAMASCUS

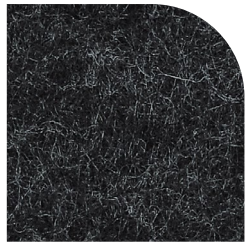

06 CHARCOAL



07 BLACK



9mm Wood Textures

Invite nature into your space with our wood-inspired textures. Digital printing on felt ensures a unique and realistic grain with virtually no repeats.

There is an additional product cost for Wood Textures.

Please note there is additional lead time for custom matching. Texture and customization will incur additional costs beyond our standard 9mm options.

Felt Thickness
9mm +/-0.5 mm

Monitors and printers vary.
Please request a material sample to verify felt colors.



D01 WHITE ASH



D02 SILVER TEAK



D03 CLEAR MAPLE



D04 WASHED ASH

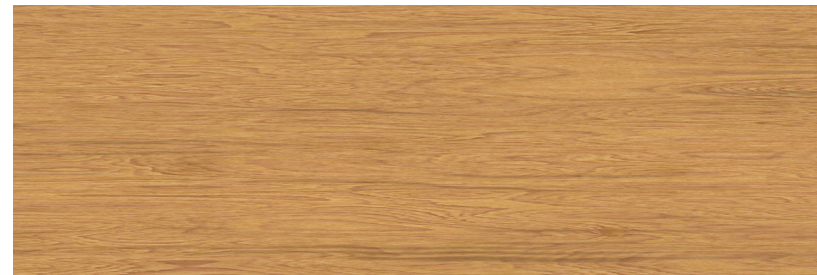

D05 MEDIUM OAK



D06 PLANKED OAK

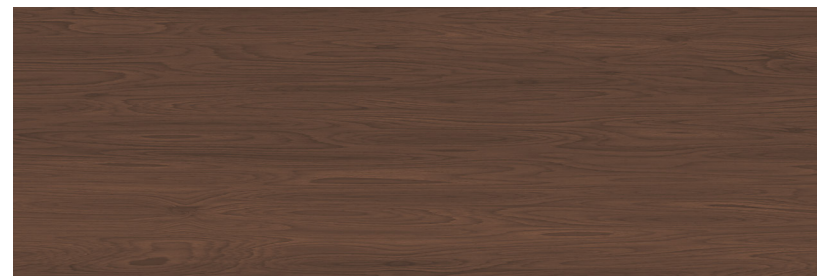

D07 DARK WALNUT



D08 BLACK PEAR

9mm Stone Textures

Inspired by nature, designed for felt. Our digitally printed Stone Textures capture the character and nuance of stone on top of a curated color collection from our Hues palette with virtually no repeats. The three patterns in this family each capture unique elements from the stones for which they are named.

There is an additional product cost for Stone Textures.

Turf has curated this collection to include only the best pattern and color combinations.

Felt Thickness
9mm +/-0.5 mm

Monitors and printers vary.
Please request a material sample to verify felt colors.

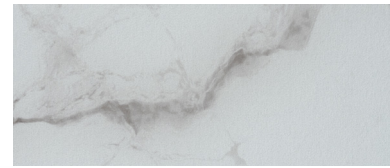

ST05 MARBLE

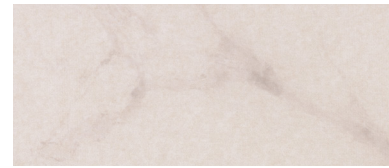

ST01 MARBLE



ST33 MARBLE

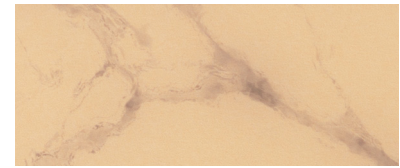

ST64 MARBLE

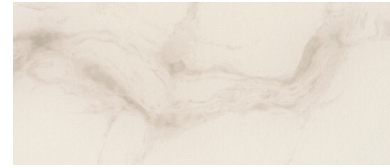

ST50 MARBLE

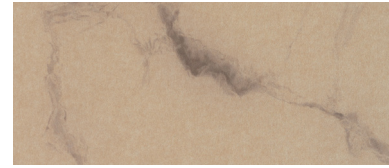

ST83 MARBLE

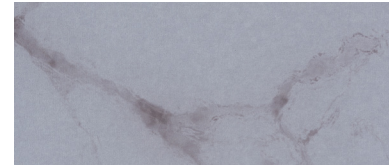

ST66 MARBLE

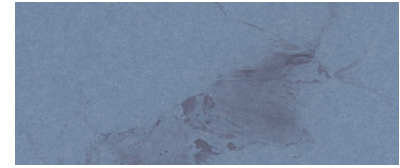

ST26 MARBLE

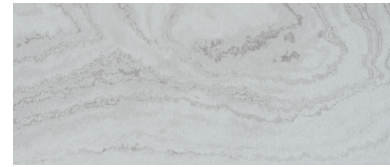

ST05 TRAVERTINE

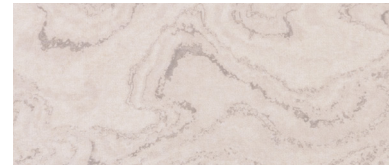

ST01 TRAVERTINE



ST50 TRAVERTINE

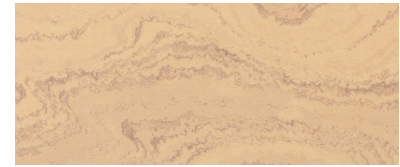

ST64 TRAVERTINE

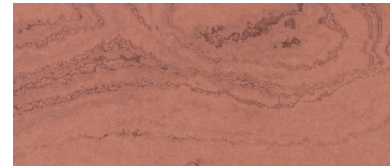

ST17 TRAVERTINE

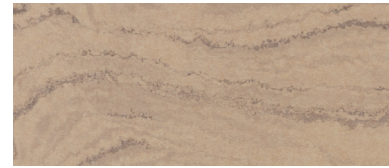

ST83 TRAVERTINE

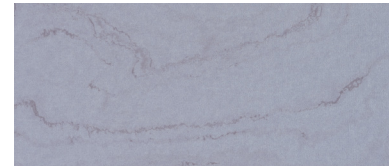

ST66 TRAVERTINE

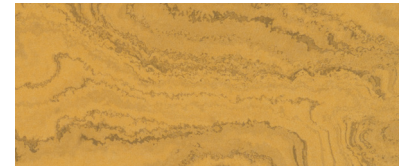

ST63 TRAVERTINE

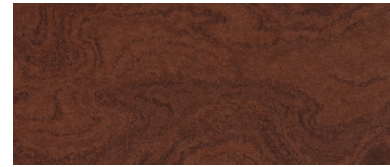

ST18 TRAVERTINE

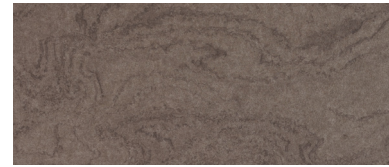

ST34 TRAVERTINE

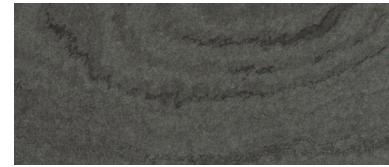

ST11 TRAVERTINE



ST26 TRAVERTINE

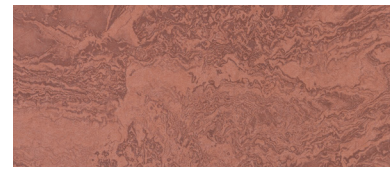

ST17 GRANITE

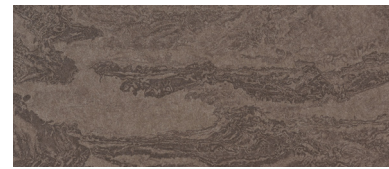

ST34 GRANITE

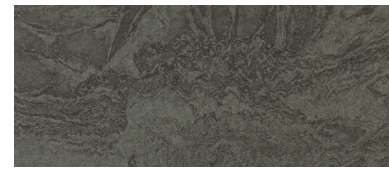

ST11 GRANITE

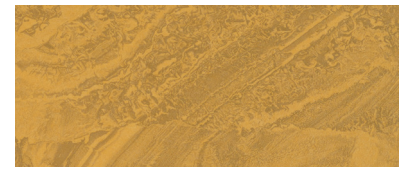

ST63 GRANITE

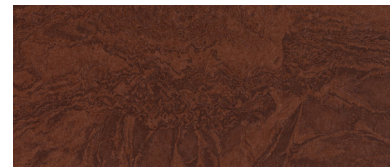

ST18 GRANITE

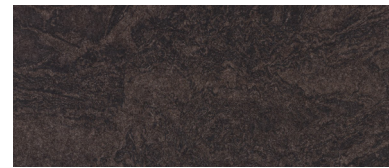

ST35 GRANITE

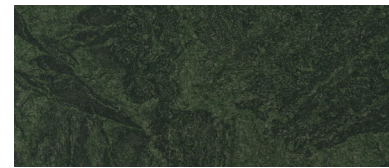

ST10 GRANITE

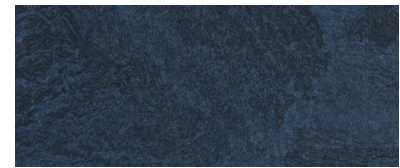

ST28 GRANITE

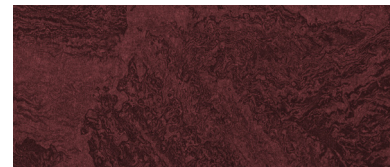

ST15 GRANITE

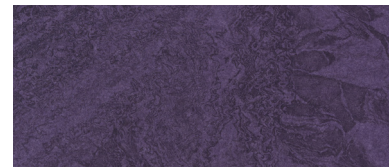

ST41 GRANITE

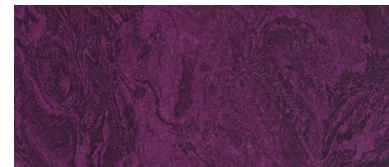

ST40 GRANITE