

Wall Scape

Tubular

Off the wall

Sleek vertical channels close in on noise. A little off-the-wall, Tubular is a planar piece that can also wrap a radius, covering pillars and other architectural elements. Quiet comes full circle with Tubular's surround-sound performance.



Image by The Right Exposure

How To Specify

Key Information

Tubular can wrap through your space in a variety of ways. Consider these questions as you design your layout.

If shop drawings are required for your project, please follow steps 1 - 5.

Fast Track

If you're looking to expedite your project, this product is available as Turf Fast Track!

Using Fast Track, our standard lead time for shop drawings is eliminated allowing the project to move directly into production.

Please note, installation and seaming drawings are not included in this process.

Turf recommends 10-15% additional panels or tiles to cover overage / attic stock.

1

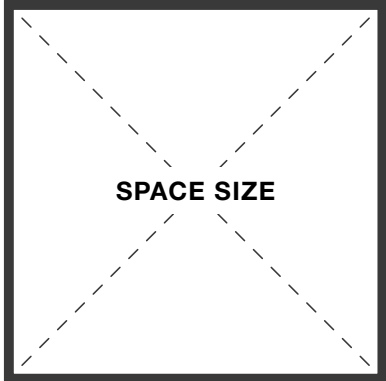

SPACE SIZE

What are the dimensions of the space?

2

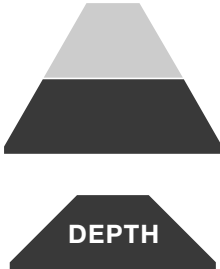

DEPTH

9mm or 18mm depth?

PAGE 3

3

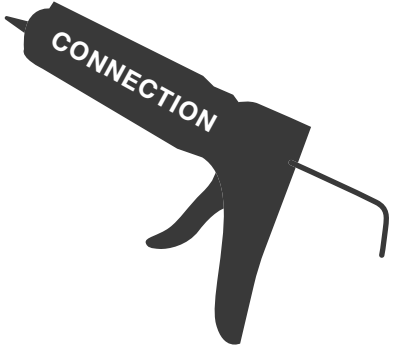

CONNECTION

Will Tubular need adhesive backing or non-adhesive?

PAGE 3

4

LAYOUT

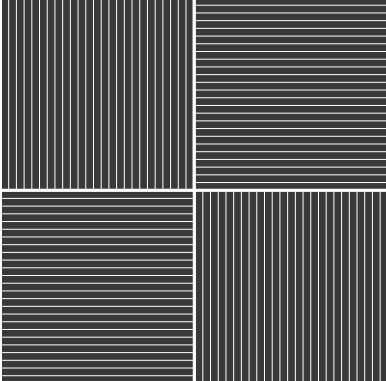

LAYOUT

What is the proposed layout?

PAGE 4

5



COLOR

What is the color?

PAGE 7

FAST TRACK



FAST TRACK

1. 9mm or 18mm depth?
2. 12" x 12" tiles, 24" x 24" tiles or panels?
Standard panels are 24" x 120", custom panel heights available upon request.
3. Do you want adhesive backing by Turf, or construction adhesive by others?
4. What is the color of the tiles or panels?
5. How many tiles or panels do you need?
6. Do you want to include any additional product for overage or attic stock?



Dimensions

Standard Tiles	12"W x 12"L, 24"W x 24"L
Standard Panel	24"W x 120"L
Variable Panel Length	12"L Min - 120"L Max
	See our Typical Layouts pages for more information on tiles and panels.
Standard Depths	9mm, 18mm

Connection Options

Standard Connection	Adhesive backing by Turf
Connection By Others	Construction adhesive
	Tiles or panels can be installed with construction grade adhesive specified by the contractor.

Color

9mm Palette	Tubular can be specified in any of our 9mm felt colors.
	See Section Details on this page for more information.

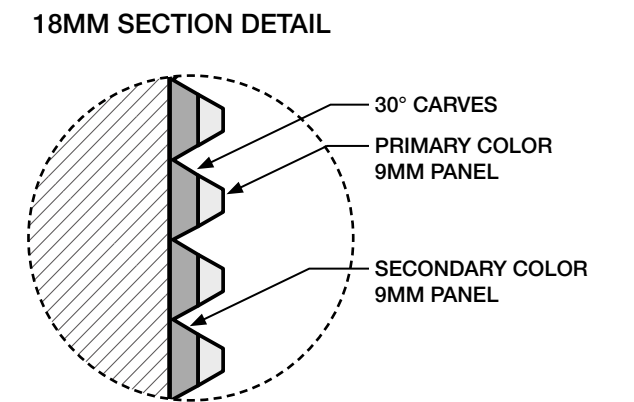
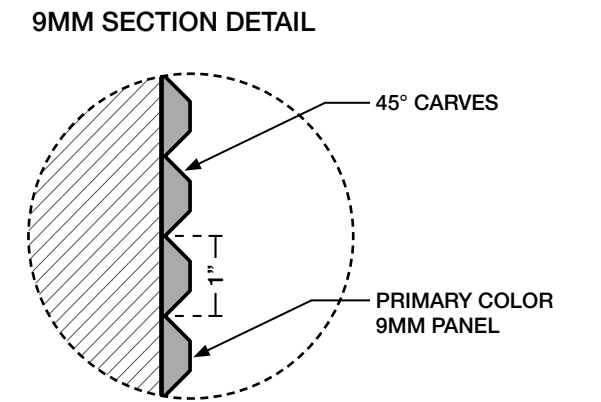
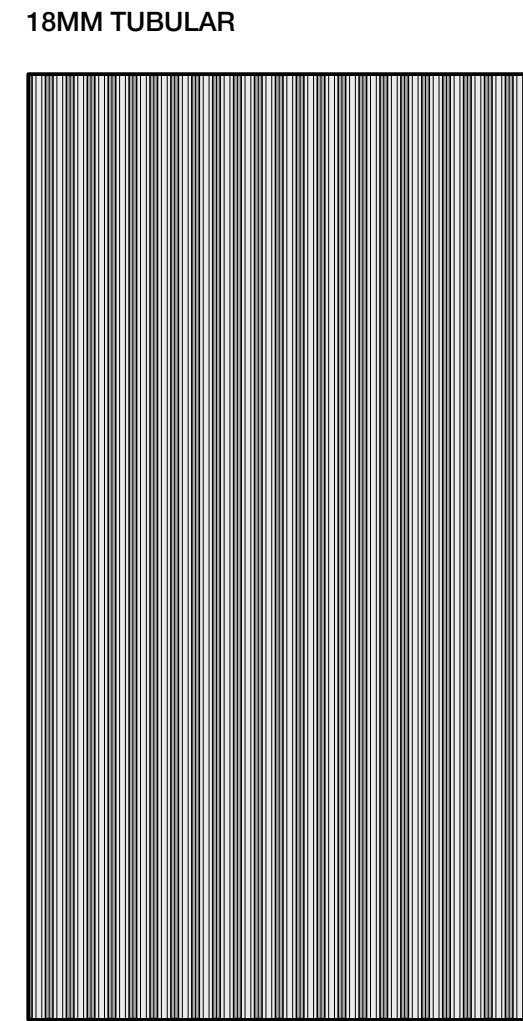
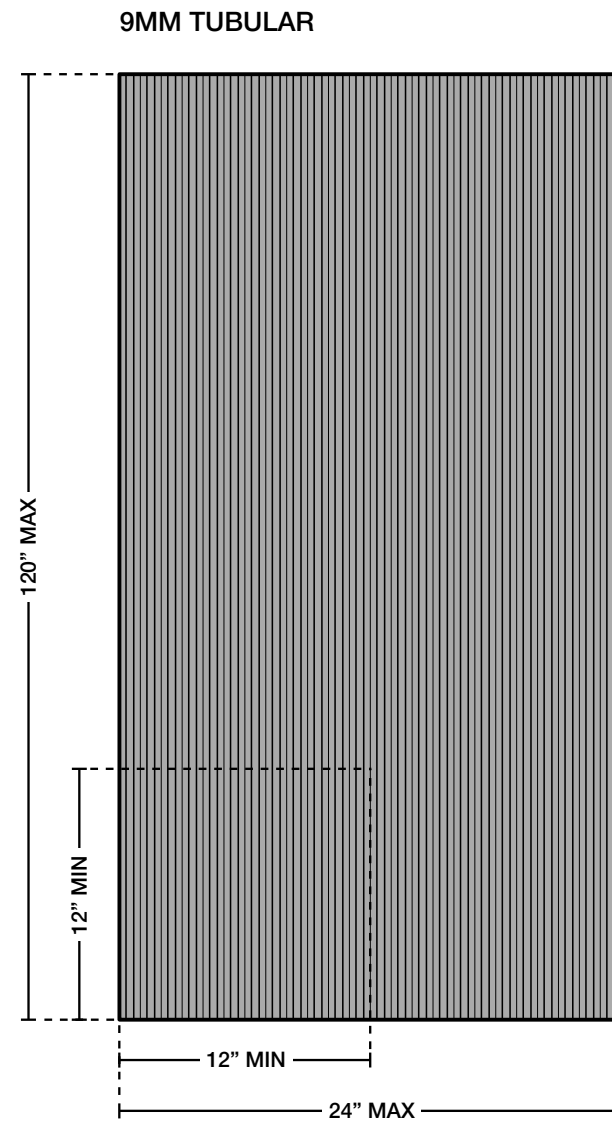

ALL DIMENSIONS NOMINAL UNLESS NOTED OTHERWISE

Typical Layouts

Vertical

Elegant and understated cylinders run top to bottom in Tubular's Vertical layout. For this layout, using panels instead of tiles is recommended.

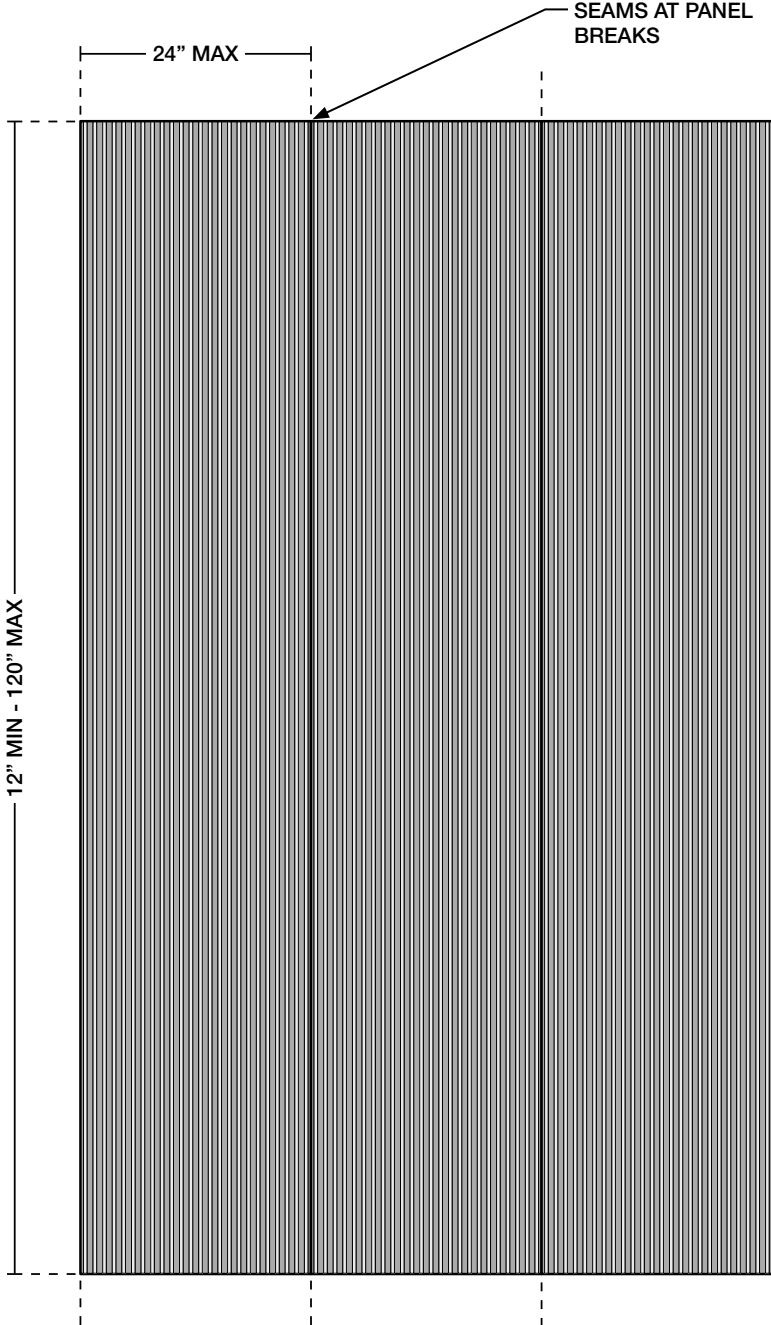

Horizontal

Simple, sophisticated lines run through Tubular's Horizontal layout. For this layout, using panels instead of tiles is recommended.

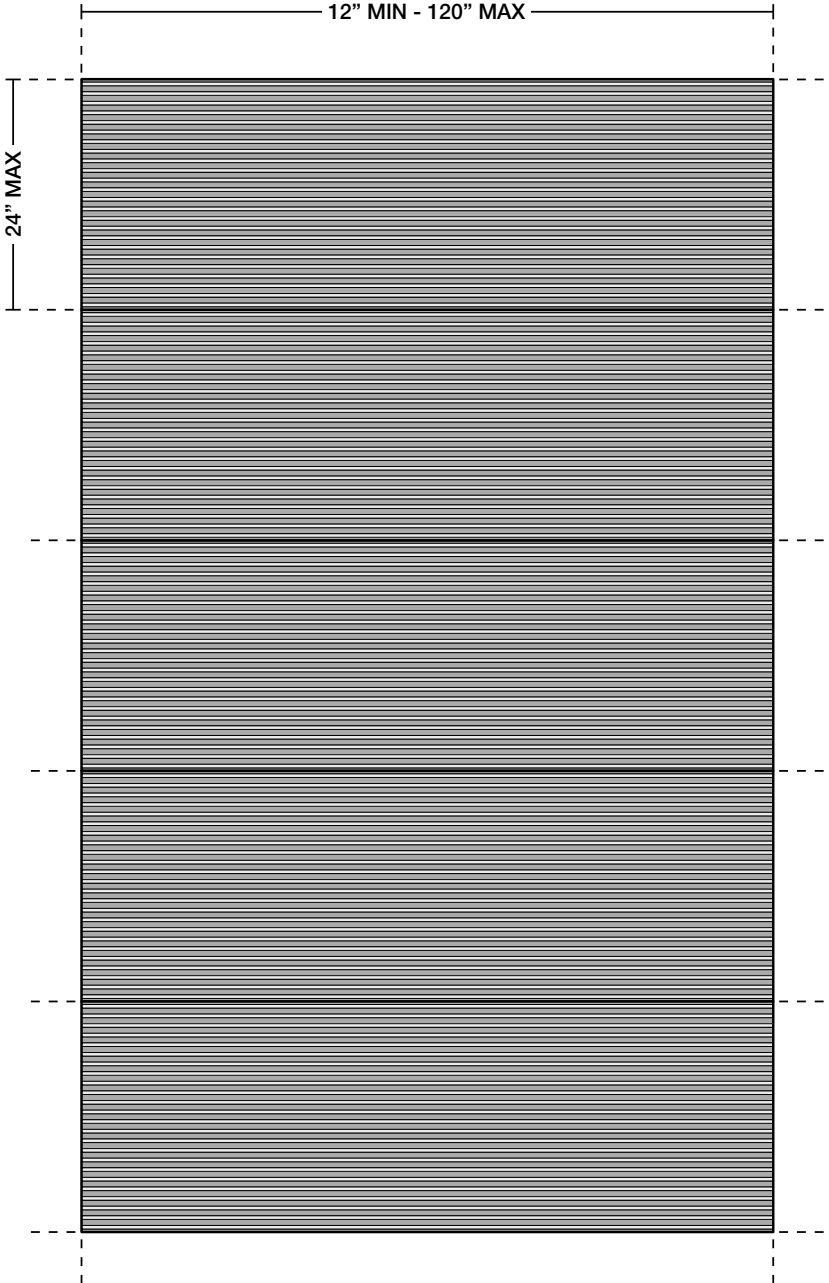

Crosshatch

Mixing tile directions, dynamic textures weave through Tubular's Crosshatch layout. For this layout, using tiles instead of panels is recommended.

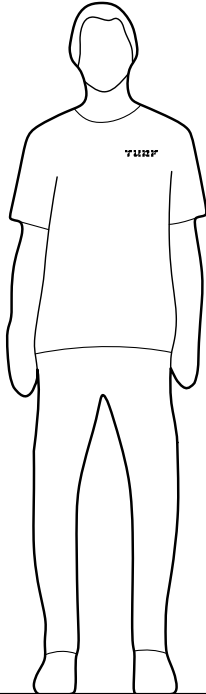
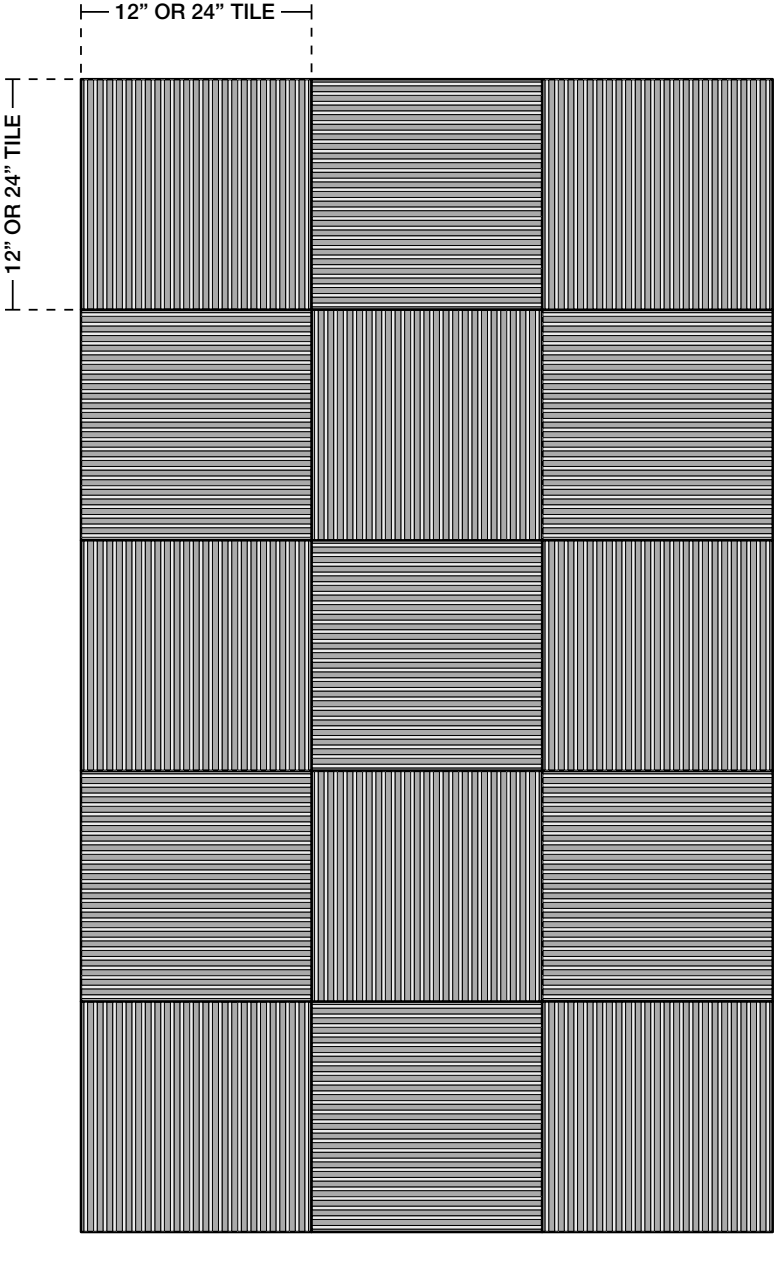

ALL DIMENSIONS NOMINAL UNLESS NOTED OTHERWISE



Installation & Field Trim Guide

Tubular is designed for a quick and easily install, and can accommodate trimming in field — just follow this simple guide.

This guide shows Tubular with Turf applied adhesive backing. Alternatively tiles or panels can be installed with construction grade adhesive specified by the contractor.

Please note, prep the wall surface before application. Clean the surface of any dust or loose debris, making sure the surface is dry before application.

Follow the link below for more detailed information on adhering Turf products to walls.

[Turf Adhesives Guide](#)

Tools Required

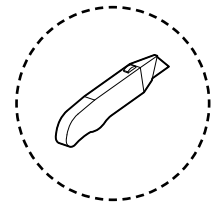

SHARP BLADE

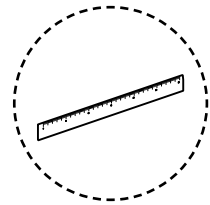

STRAIGHT EDGE

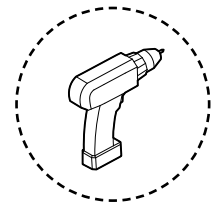

DRILL

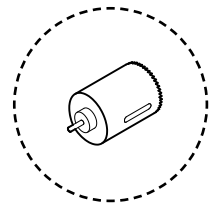

HOLE SAW

1 - ADHESIVE BACKING BY TURF

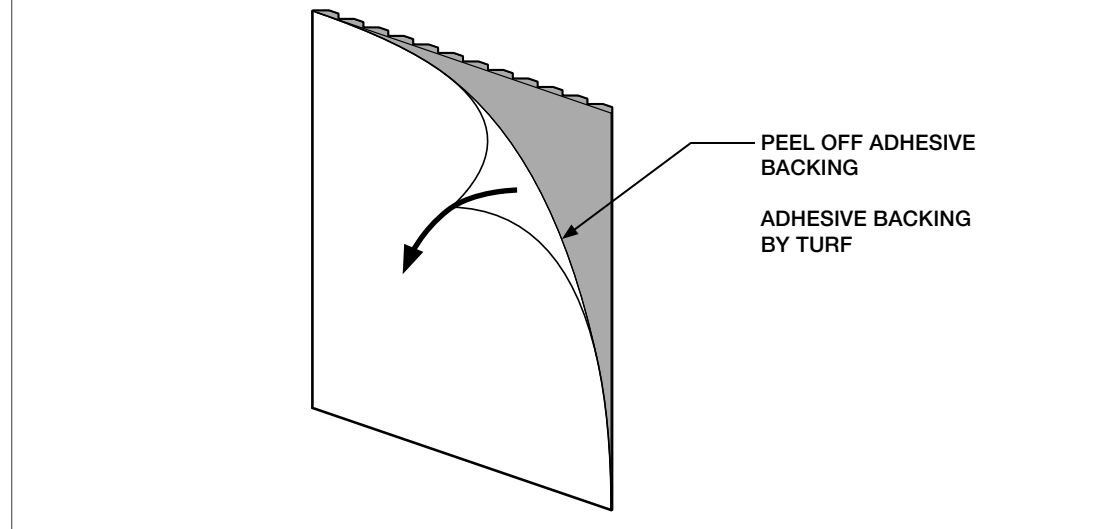

2 - MOUNT TUBULAR TO WALL

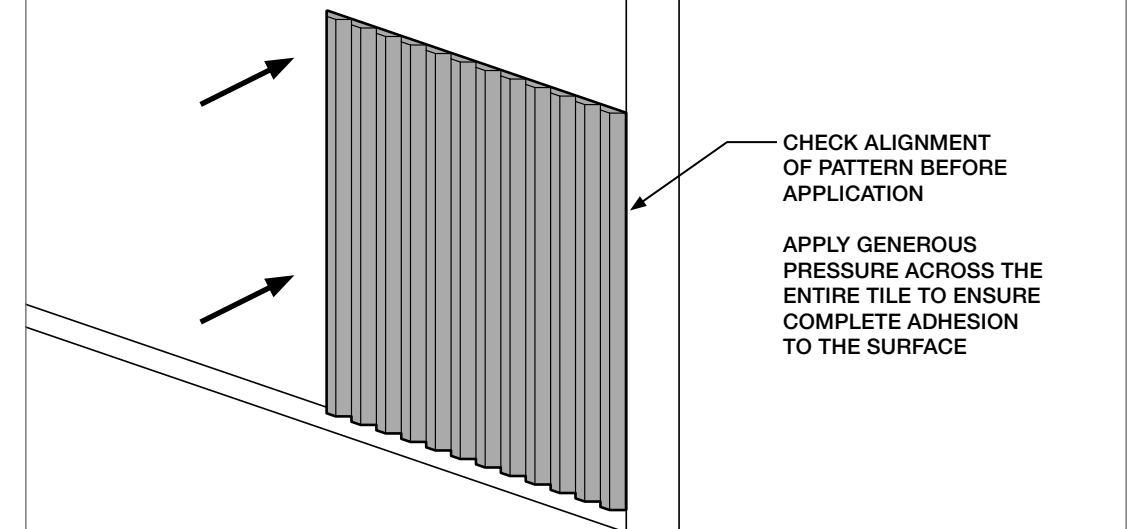

3 - WRAPPED TUBULAR INSTALLATION

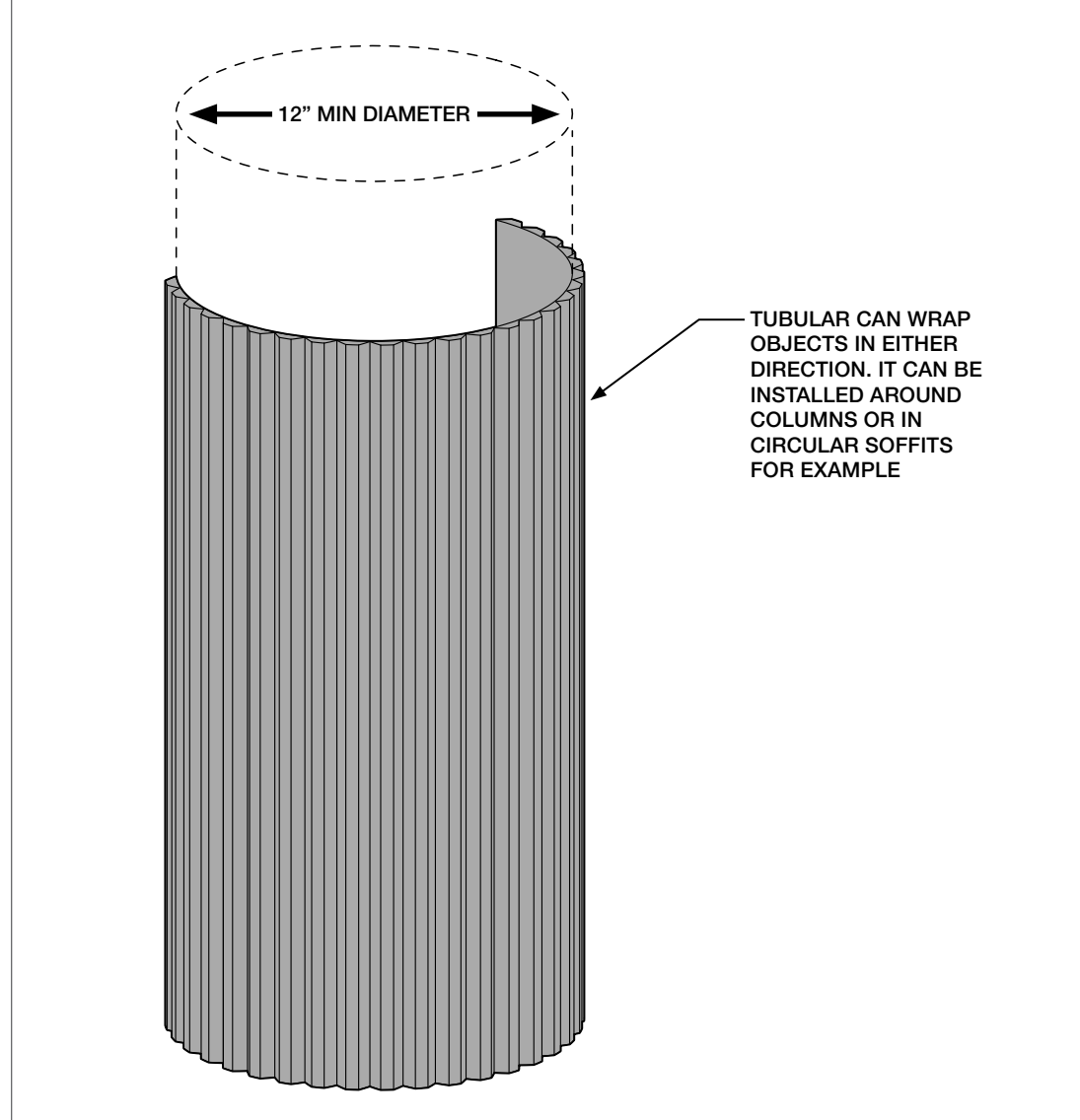

4 - TRIM AS REQUIRED

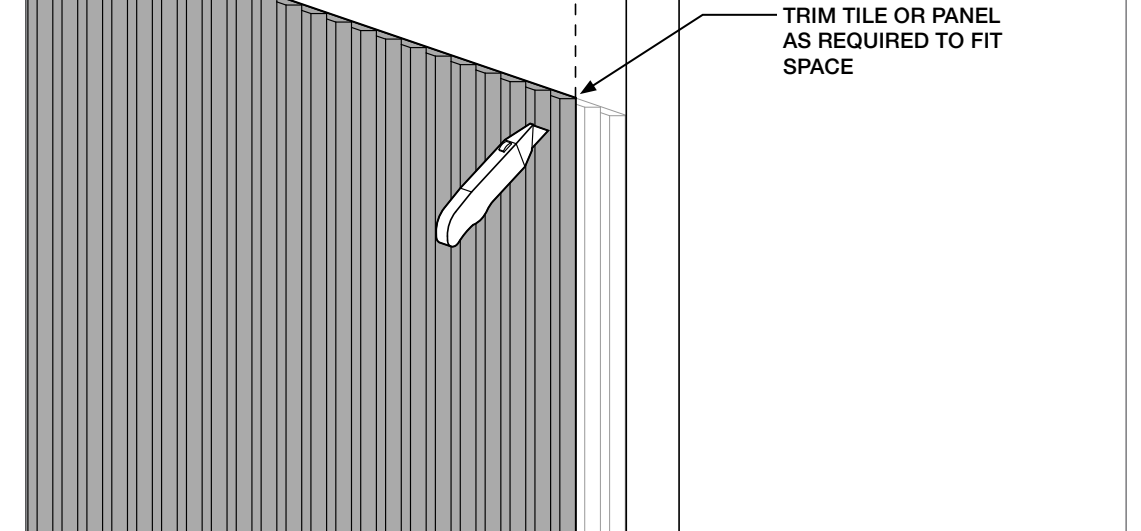

5 - TRIM CIRCULAR HOLES

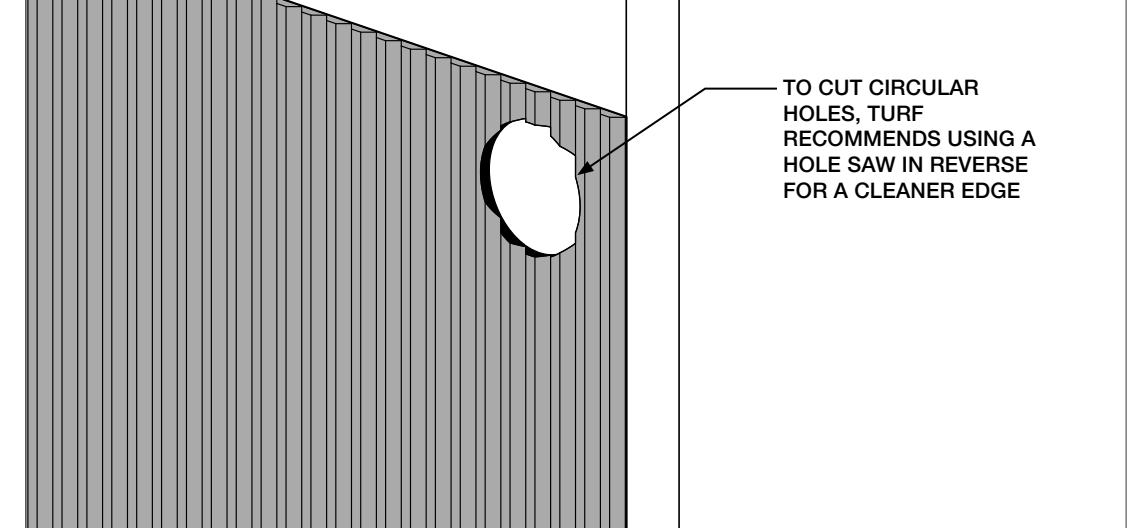

Tech

Acoustics	ASTM C 423-17: Type A
Fire Rating	ASTM E-84 – Class A
VOC	ASTM D5116 Compliant

Details

Lead Time	Check the Turf website for current lead times.
Warranty	Five (5) years
Maintenance	Vacuum to remove any particulate matter and air-borne debris or dust. Compressed air can be used to dust the material in difficult to reach areas for large assemblies. Contact us for more information relative to spot cleaning.
Weight	Turf products cannot support the weight of any other items in field.
Trademarks	Turf®, FeltLock™, GridLock™, T™ are trademarks of Turf Design, Inc. and/or its affiliates © 2025 Turf Design Inc. Printed in the United States of America

Acoustic Rating

9mm Tile	NRC = 0.25
18mm Tile	NRC = 0.40

Carved wall tile NRC varies depending on field conditions and arrangement. Contact Turf for testing details.

Certifications

Declare.



Photo by Brandon Stengel, Farm Kid Studios



Photo by Brandon Stengel, Farm Kid Studios

9mm Colors

Introducing Hues, our new 9mm color palette designed for the senses.

The 9mm PET felt board is used as our primary construction material. Select one of our coordinating neutrals to blend in, or go for a contrasting element with one of our hues.

The process used to create PET felt often results in a heathered effect where multiple tones are present. Slight variations in color should be expected when using this sustainable material.

Felt Thickness
9mm +/-0.5 mm

Monitors and printers vary. Please request a material sample to verify felt colors.



10 TOPO GREEN



12 GRASSHOPPER

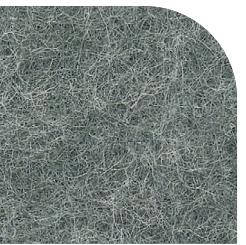

11 CELADON

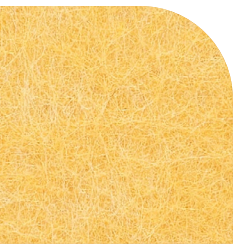

63 SAFFLOWER

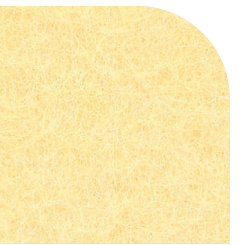

64 PLANTAIN

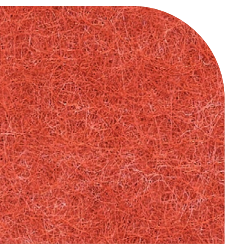

43 ORANGE CRUSH

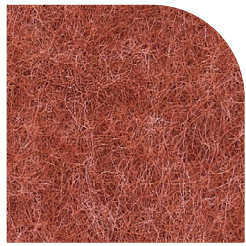

18 ULTISOL



17 BLUSH

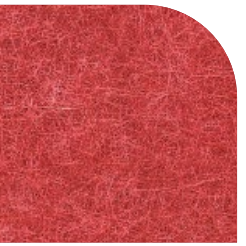

23 RED

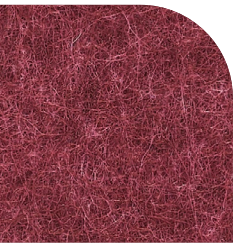

15 MERLOT

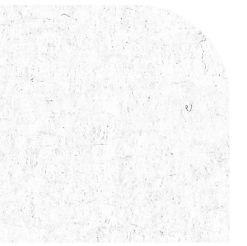

50 IVORY



33 LUMINARY



83 HOLLAND OATS



82 BARLEY



34 TONAL TAUPE



35 BARK

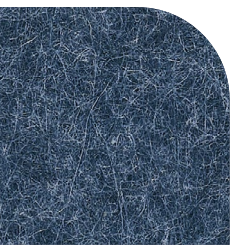

28 INDIGO

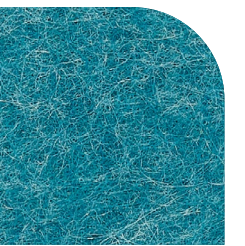

30 CYAN

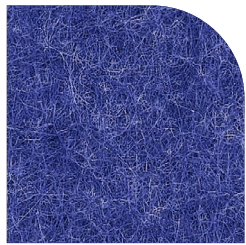

24 ROYAL BLUE

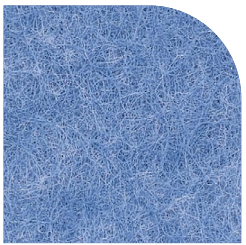

31 AZURE

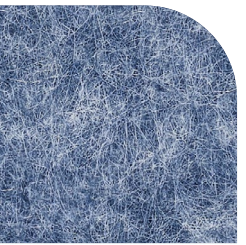

27 JEAN JACKET

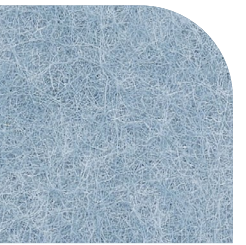

26 FADED DENIM

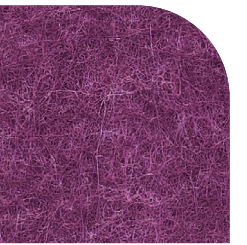

40 MAGENTA

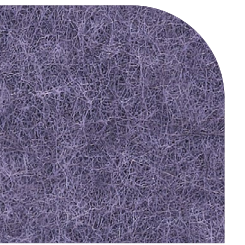

41 DRIED LAVENDER

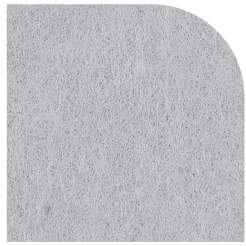

66 PEWTER



05 WHITE

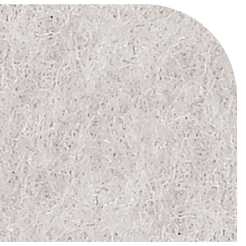

01 CREAM

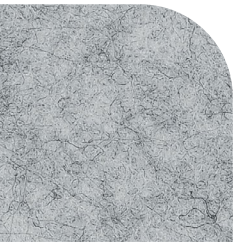

04 LIGHT GREY



98 STORM

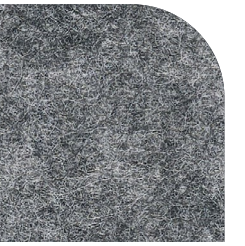

09 DAMASCUS



06 CHARCOAL



07 BLACK

