

Wall Scape

Monolith

Pillars of quiet

Dramatic forms, easy-listening.
Simple, rectangular forms—tall and
narrow—create a landmark wall scape.
Stone texture options offer monumental
aesthetics that tone down sound.



Photo by Kendall McCaugherty, Hall+Merrick+McCaugherty

How To Specify

Key Information

Monolith can heighten your space in a variety of ways. Consider these questions as you design your layout.

If shop drawings are required for your project, please follow steps 1 - 2.

Quick Ship

If you're looking to expedite your project, this product is available as Turf Quick Ship!

Using Quick Ship, our standard lead time for shop drawings is eliminated allowing the project to move directly into production.

Please note, installation and layout drawings are not included in this process.

Turf recommends an additional 10-15% additional panels to cover overage / attic stock.

Stone Textures & Graphic Print

Monolith projects that use new Stone Textures or Graphic Print are not available for Quick Ship. Turf's design team can help guide you through these use cases.

1

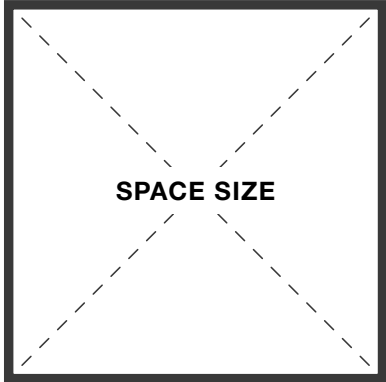

SPACE SIZE

What are the dimensions of the space?

2

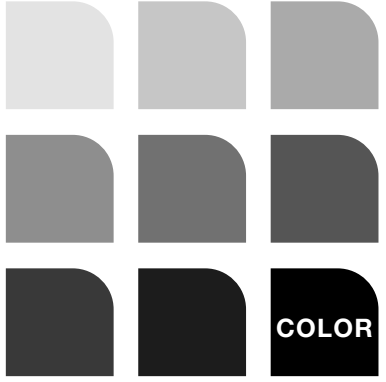

COLOR

What is the color or texture?

PAGE 14-16

3

STONE TEXTURES



If using Stone Textures, what is the proposed layout?
Book, Slip, Reverse Slip, Aesthetic or Continuous?

PAGE 5-9

4

GRAPHIC PRINT

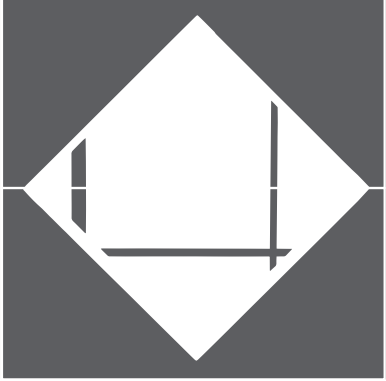

GRAPHIC PRINT

If using Graphic Print, What art do you want printed?

*Available Summer 2024

PAGE 10

QUICK SHIP



1. What size panels do you need?
2. What color are the panels?
3. How many panels do you need?
4. Do you want to include any additional product for overage or attic stock?



Dimensions

Standard Panel Size	24"W x 116"H x 2"D
Variable Width	12"W Min - 24"W Max
Variable Height	60"H Min - 116"H Max
Layout Types	Book Match Slip Match Reverse Slip Match Aesthetic Match Continuous Match Graphic Print
	See "Layout Type" pages for more information.

Connection

Wall Connection	Z-Clip
-----------------	--------

Color

9mm Palette	Monolith can be specified in any of our 9mm felt colors or Textures. Please note, Wood Textures do not coordinate with the various Layout Types.
-------------	--------------------------------------------------------------------------------------------------------------------------------------------------

Stone Textures	Monolith is designed with our Stone Textures in mind.
----------------	-------------------------------------------------------

See "9mm Stone Textures" page for the full range of options.

Graphic Print	UV ink creates colorful possibilities for Turf's felt. The acoustic performance isn't affected by printing, and with color matching, walls can expand the experience of a branded space.
---------------	------------------------------------------------------------------------------------------------------------------------------------------------------------------------------------------

*Available Summer 2024

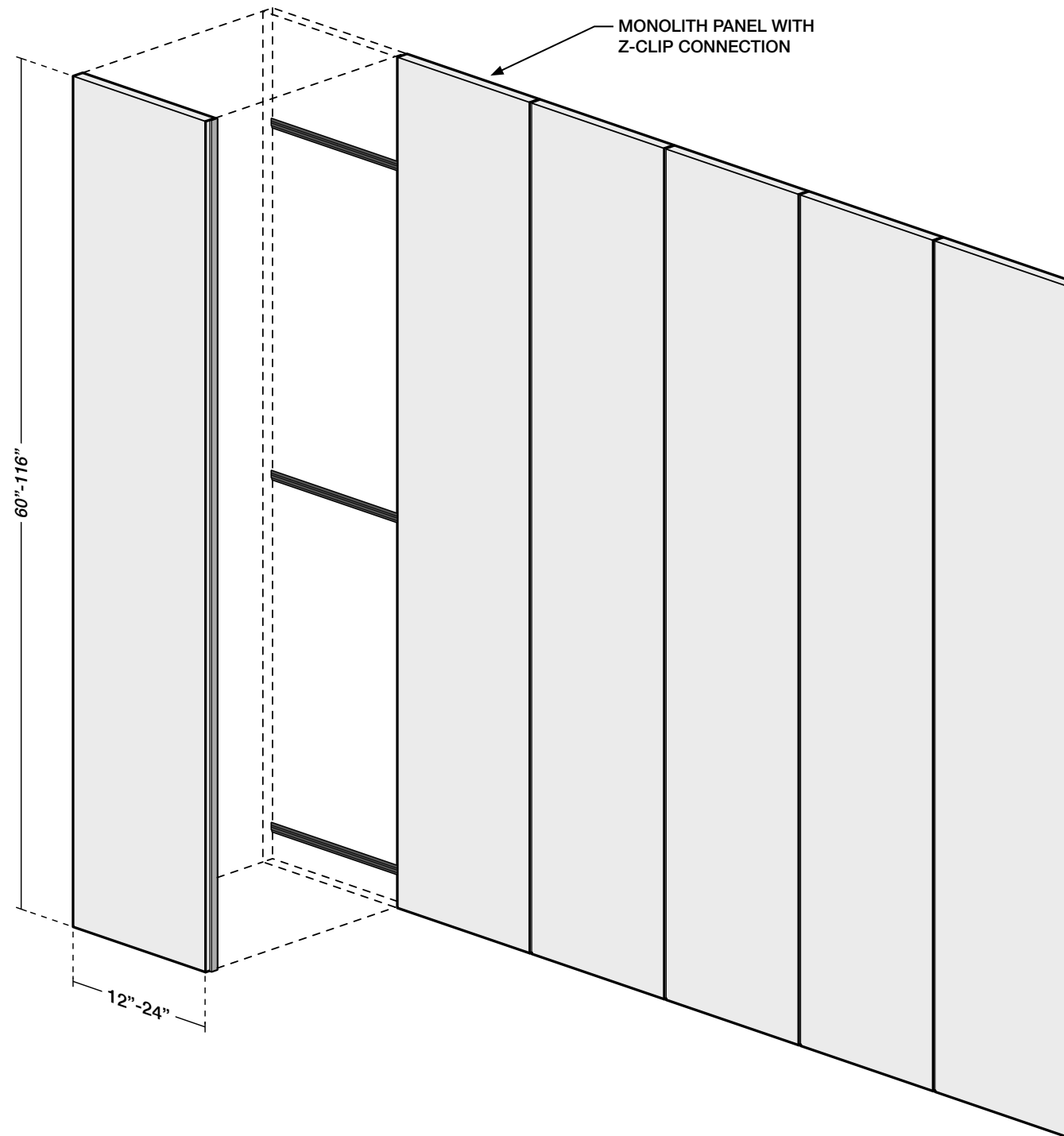

REVEAL STRIP DETAIL

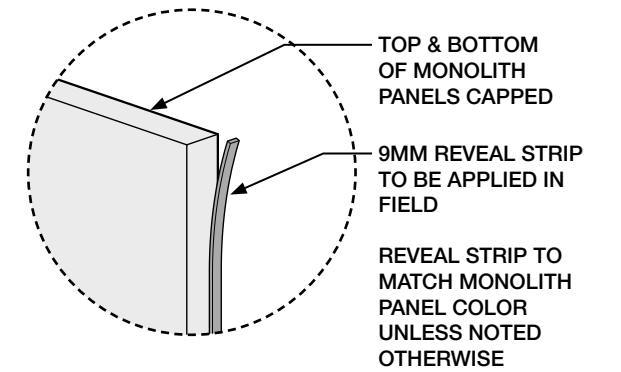

PANEL JOINT DETAIL

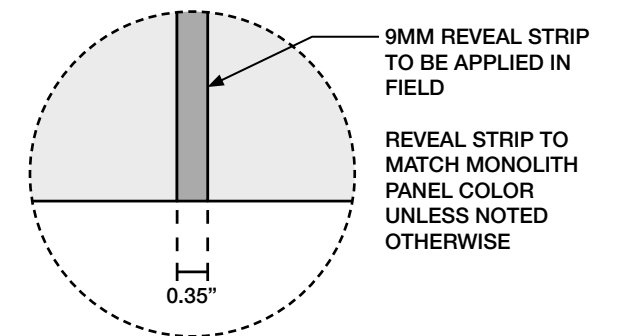

Z-CLIP WALL DETAIL

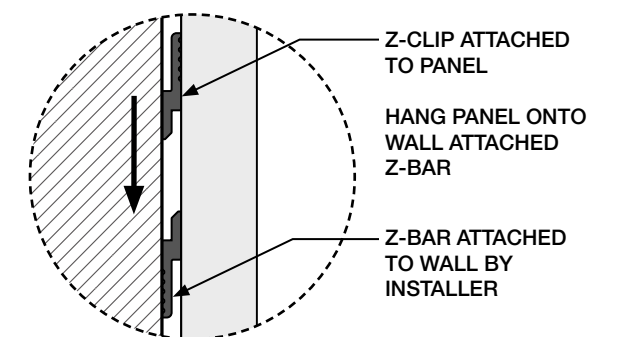

ALL DIMENSIONS NOMINAL UNLESS NOTED OTHERWISE



Panel Details

Design

Monolith can cover existing walls, elevating spaces and balancing sound. Panels are designed for wall use only. Stone Textures and Graphic Prints are both available.

Panel Depth

Panels have a flat face on the panel's front and are 2" deep.

There are portions of the panel that are completely enclosed and portions only as thick as the material.

Please see "Back of Panel" and "Panel Section" drawings for more information.

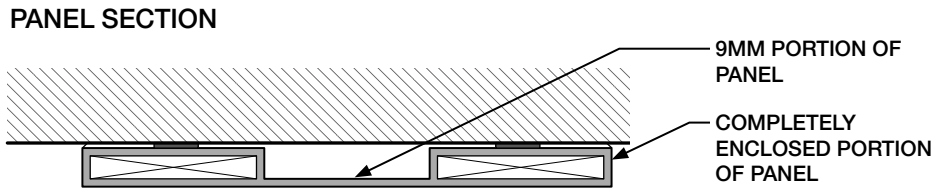
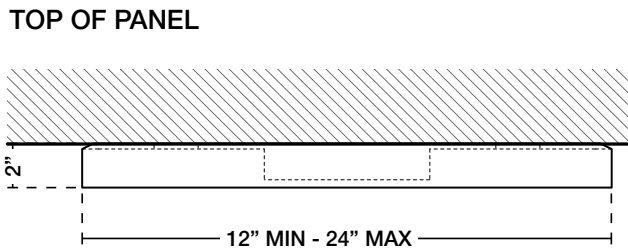
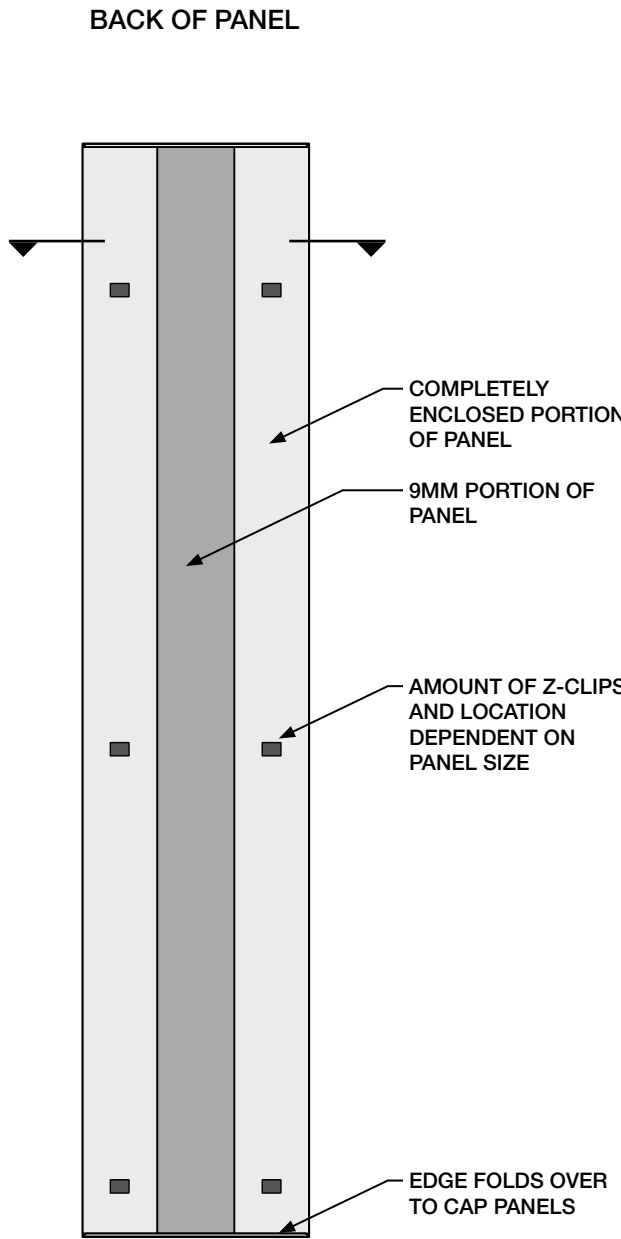
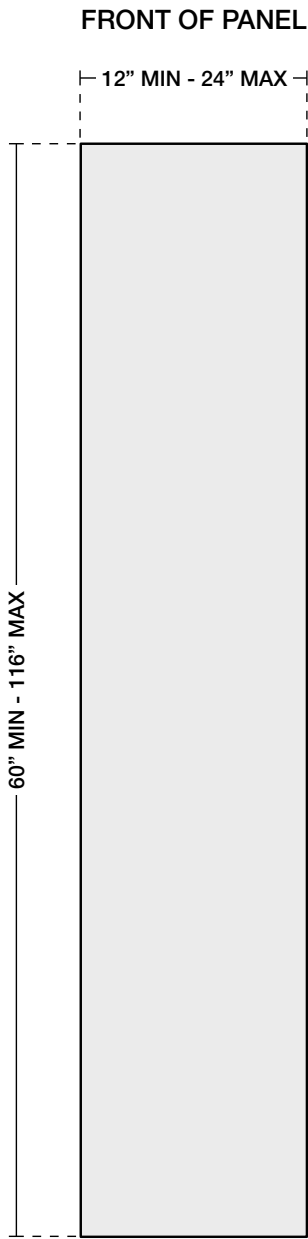

Stone Layout Type - Book Match

Description
 Book matching allows the texture to flow from panel to panel & mirror at any edge along the layout. Panels can be book matched along vertical and horizontal axes, creating a seamless pattern.

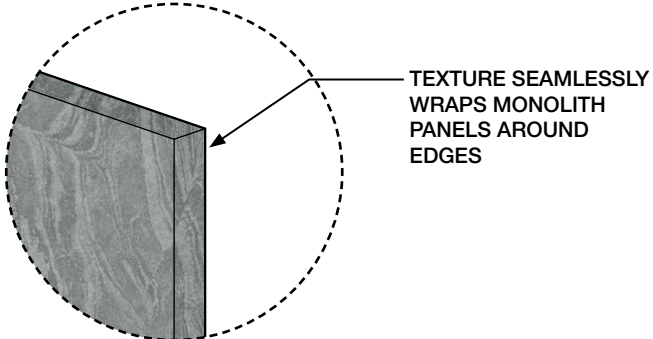

Book Match Considerations
 The book match line must occur between panels, and can be placed at any panel edge along the wall.

Monolith can be book matched in the middle of your layout, or anywhere in between to create something unique.

Example Shown
 This Layout Type is available in all Stone Texture options, the example shown uses ST11 Granite.

See the "9mm Stone Textures" page for more details.

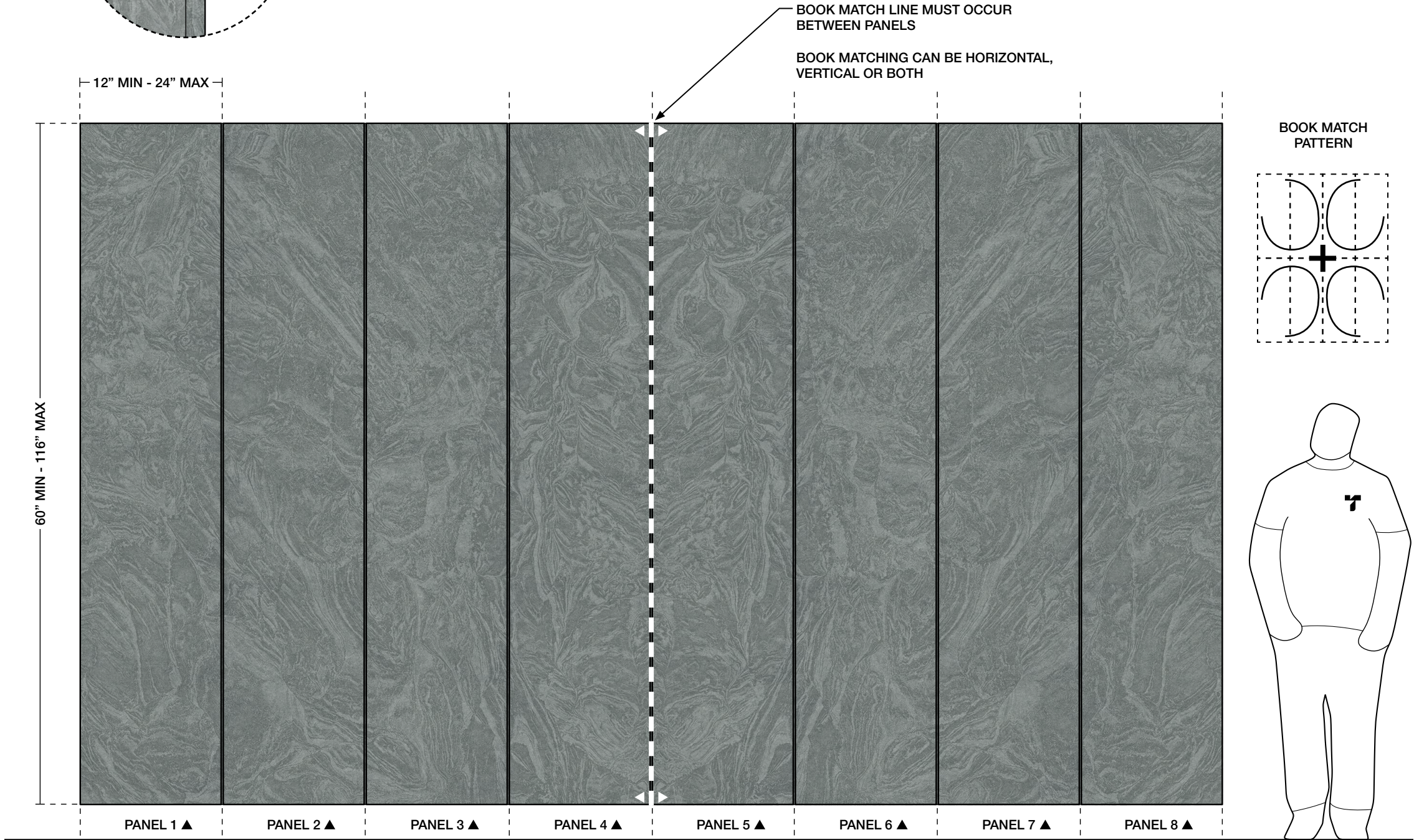

BOOK MATCH EXAMPLE



Stone Layout Type - Slip Match

Description Slip matching creates a stamped look by using a single panel in the same orientation.

Example Shown This Layout Type is available in all Stone Texture options, the example shown uses ST17 Travertine.

See the "9mm Stone Textures" page for more details.

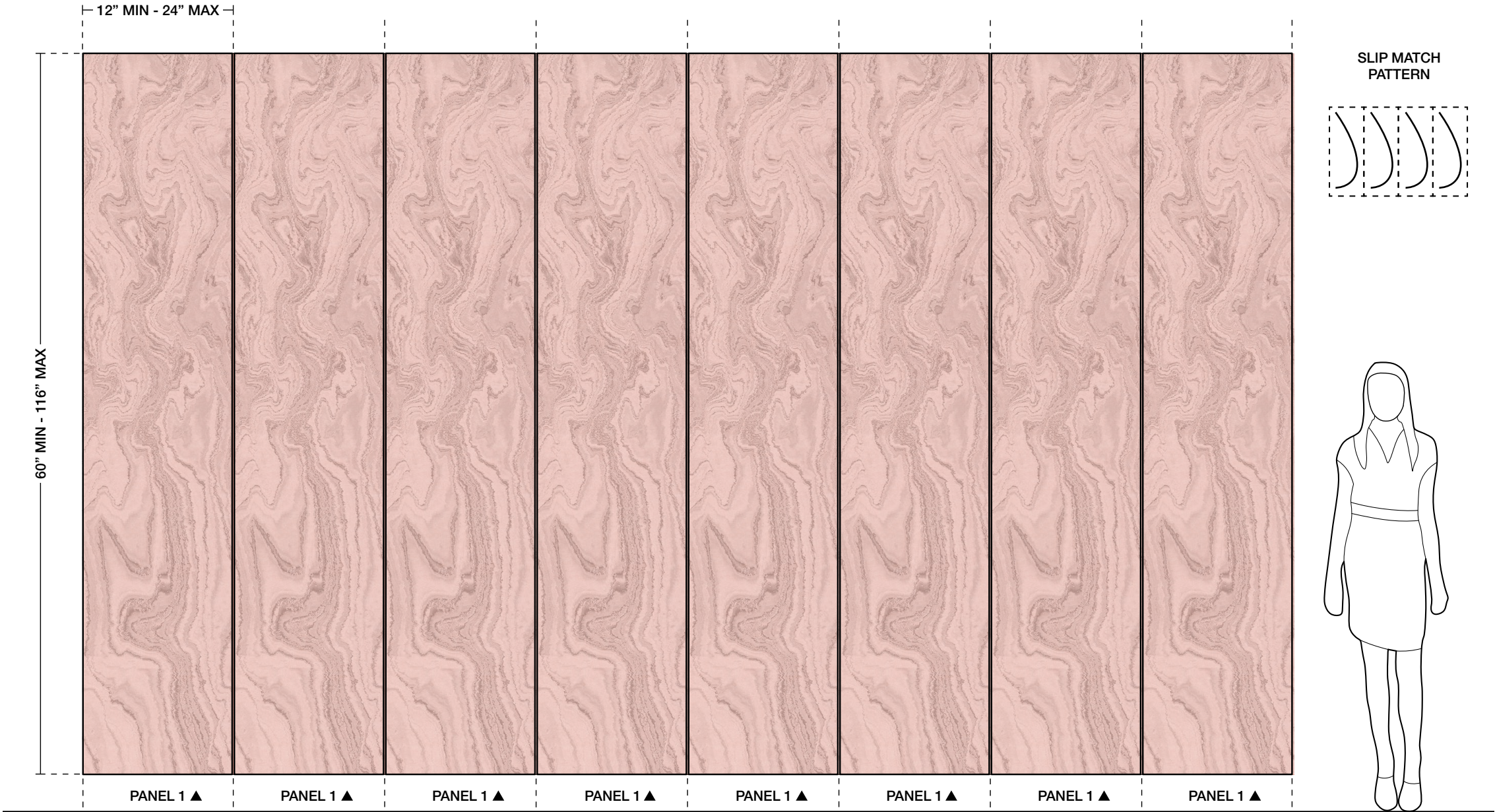

SLIP MATCH EXAMPLE



Stone Layout Type - Reverse Slip Match

Description Reverse slip matching creates an alternating stamped look by reversing the orientation of a single panel.

Example Shown This Layout Type is available in all Stone Texture options, the example shown uses ST83 Travertine.

See the "9mm Stone Textures" page for more details.

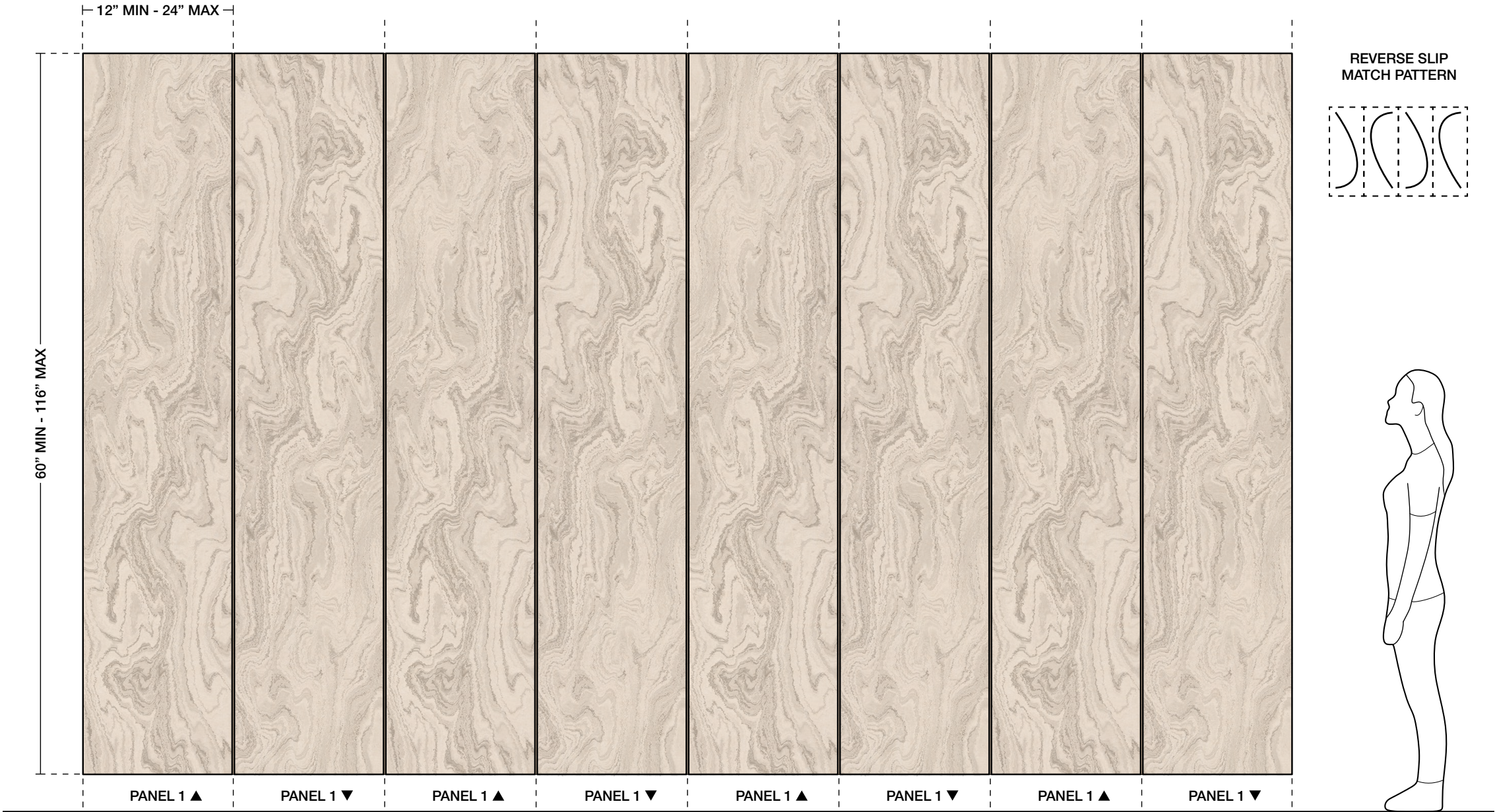

REVERSE SLIP MATCH EXAMPLE



Stone Layout Type - Aesthetic Match

Description Aesthetic matching creates a varied look by using the same texture in different locations and orientations.

Example Shown This Layout Type is available in all Stone Texture options, the example shown uses ST18 Granite.

See the "9mm Stone Textures" page for more details.

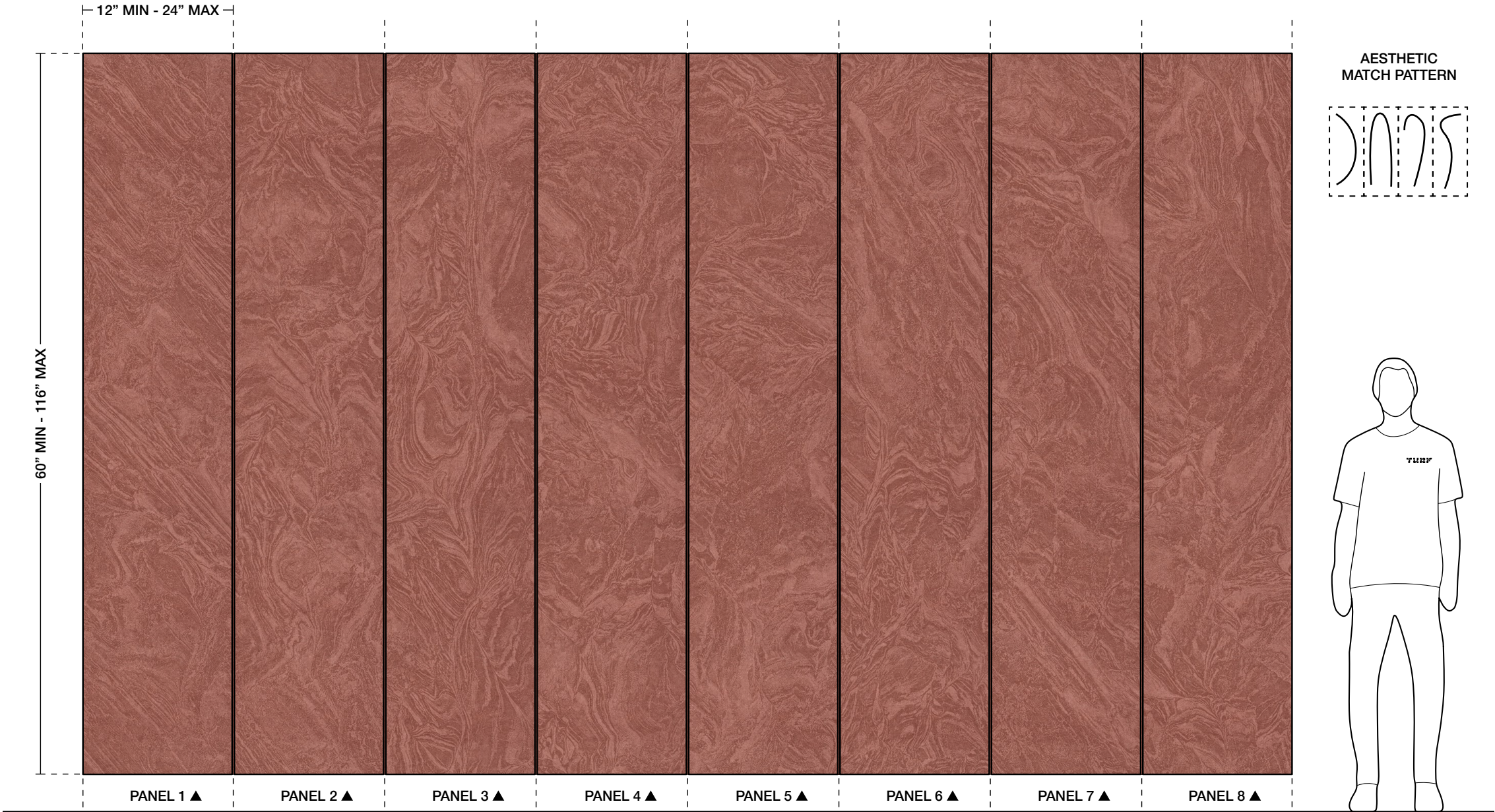

AESTHETIC MATCH EXAMPLE



Stone Layout Type - Continuous Match

Description Continuous matching creates a look that seamlessly flows across all panels in your space.

Example Shown This Layout Type is available in all Stone Texture options, the example shown uses ST05 Marble.

See the "9mm Stone Textures" page for more details.

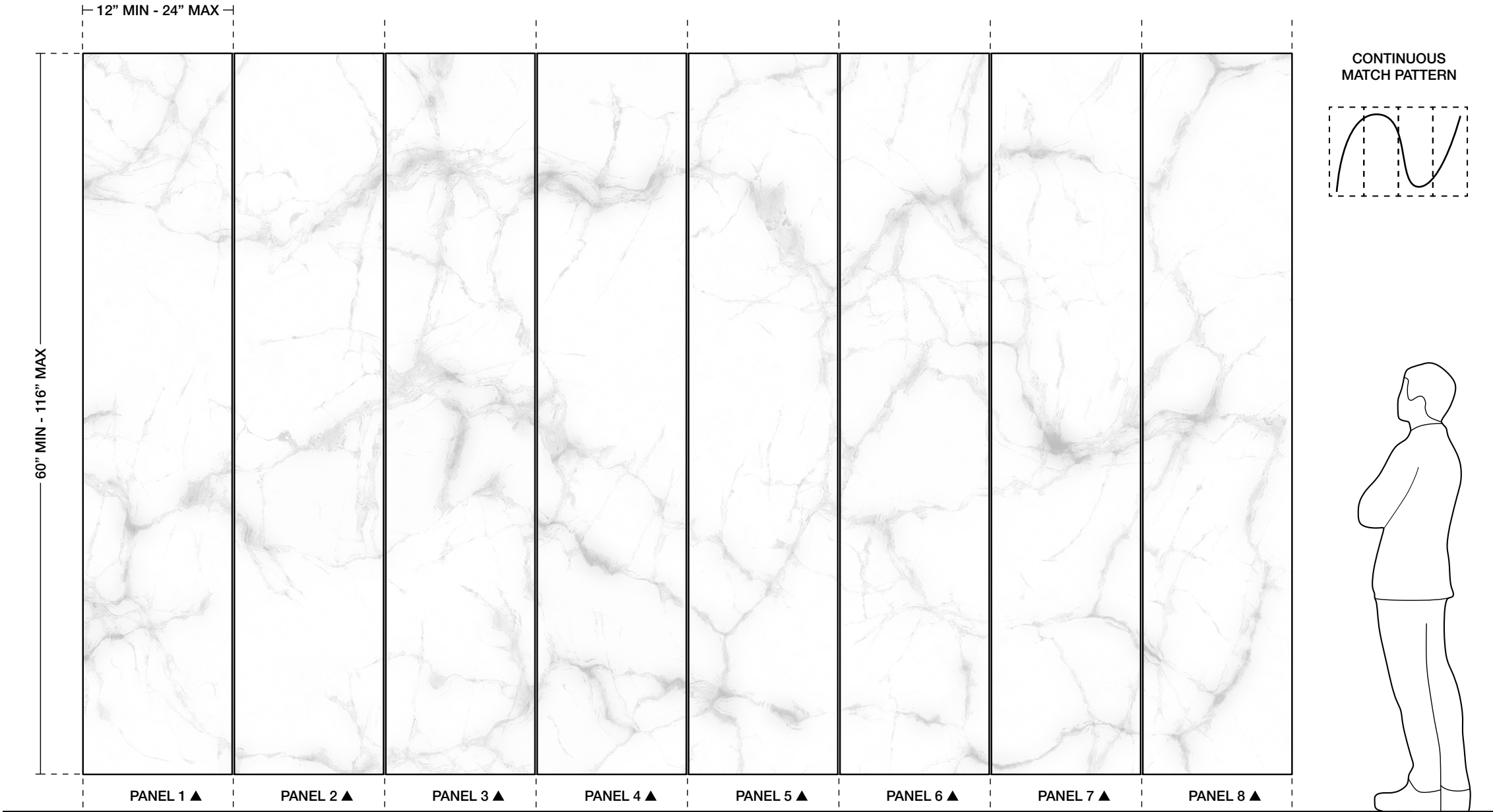

CONTINUOUS MATCH EXAMPLE



Layout Type - Graphic Print

Availability Please note, Graphic Print will be available Summer 2024.

Artwork Specifications Print ready artwork must be provided in a vector file format (either AI or EPS) or high-resolution (300dpi) raster file. The files should be in a CMYK format.

Colors must be specified in CMYK, Pantone Uncoated, or by physical sample.

If the artwork is printed on a colored substrate, details will need to be outlined. Keep in mind that the print on each panel will wrap around the edge.

Proportion To avoid cropping, please provide artwork with matching proportions to your desired space.

Strike Offs An 18"W x 18"L strike off will be provided for client approval.

Cleaning Guide Refer to the Turf website for product cleaning guidelines.

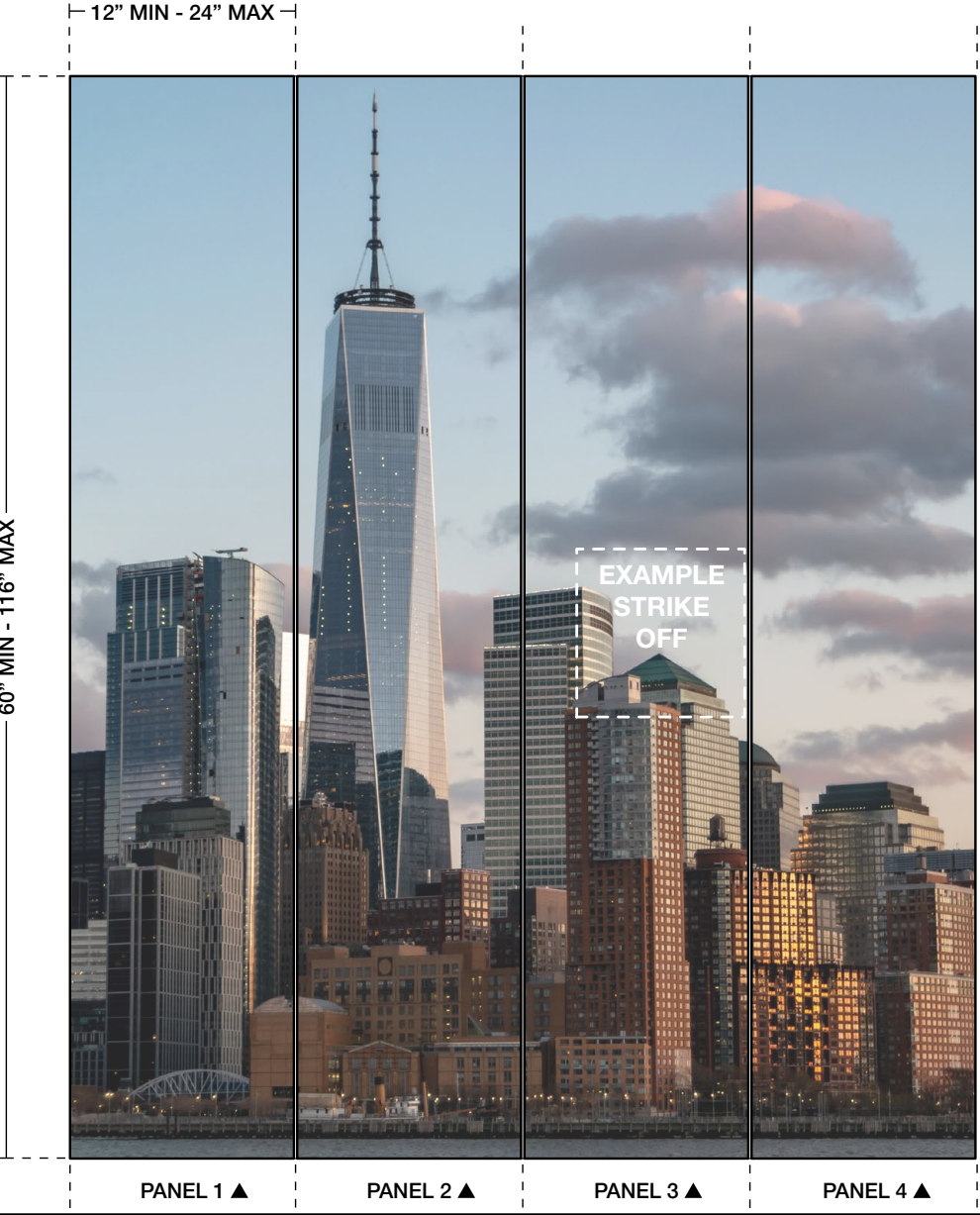
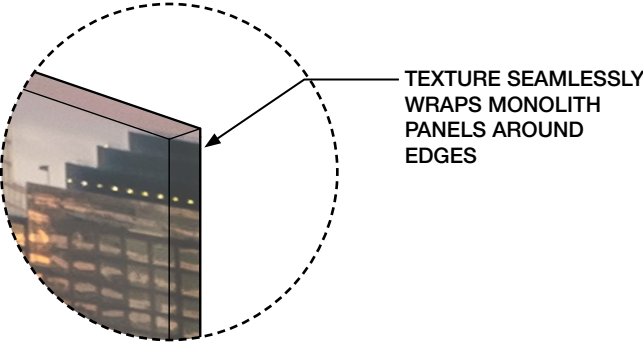

EXAMPLE GRAPHIC PRINT

EXAMPLE CLIENT PROVIDED ARTWORK



EXAMPLE STRIKE OFF

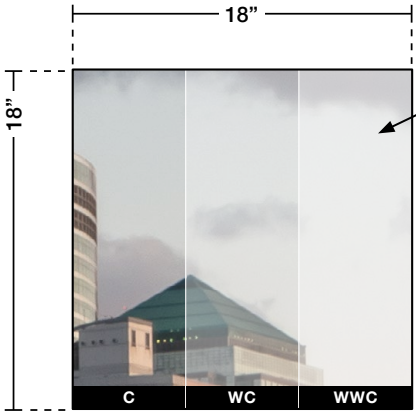

ARTWORK MUST BE A VECTOR FILE (AI OR EPS) OR A HIGH-RESOLUTION (300 DPI) RASTER IMAGE

STRIKE OFF WILL SHOW THREE COLOR OPTIONS
 PRINT ONLY (C)
 1 WHITE FLOOD (WC)
 2 WHITE FLOOD (WWC)

ALL DIMENSIONS NOMINAL UNLESS NOTED OTHERWISE



Installation Guide

Monolith panels are designed for quick and easily installation onto the wall — just follow this simple guide.

Tools Required

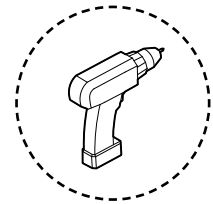

DRILL

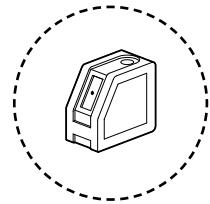

LASER LEVEL

1 - HANDLING PANELS

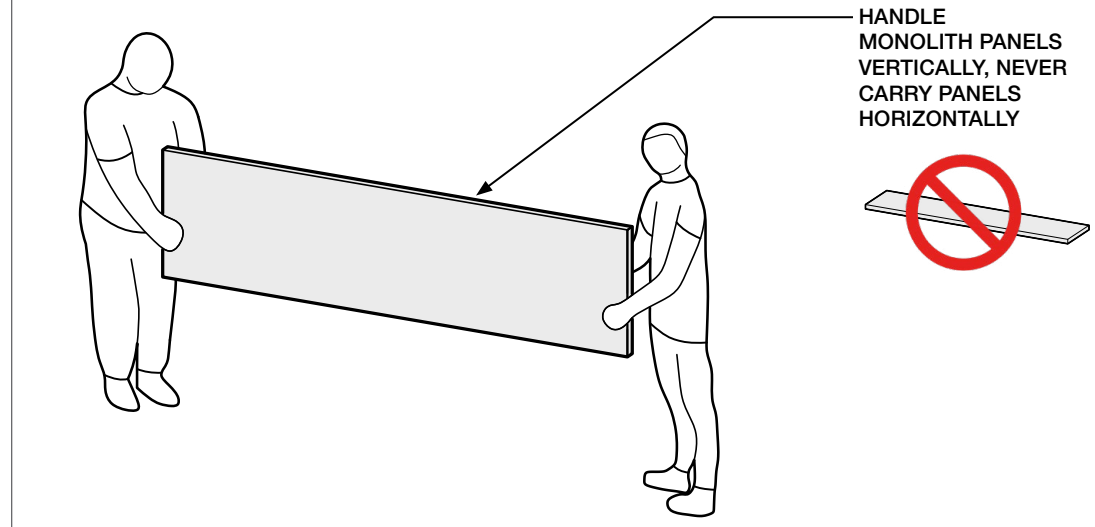

2 - USE STORY POLE TO SET LASER LINE

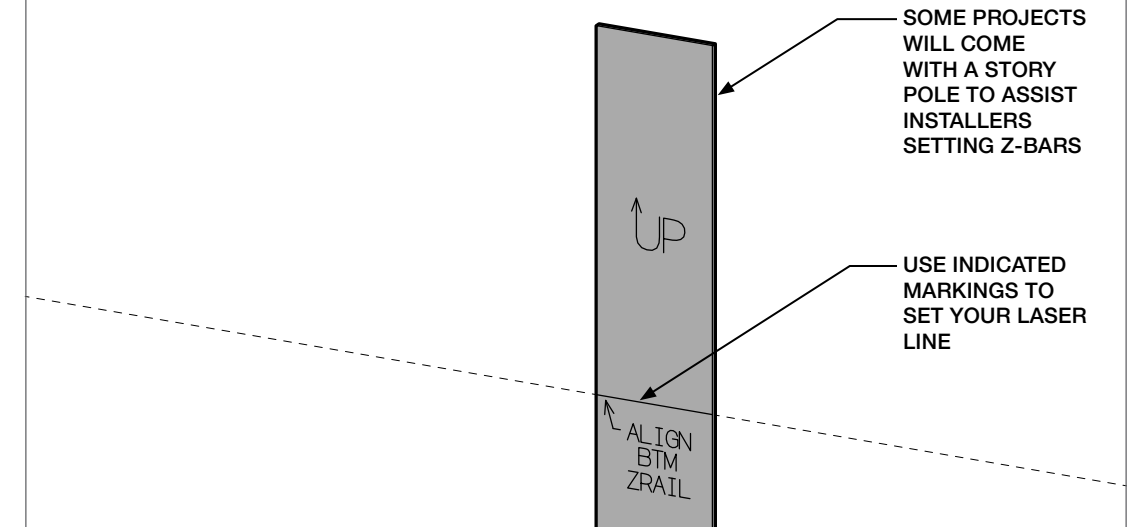

3 - ATTACH Z-BAR TO WALL

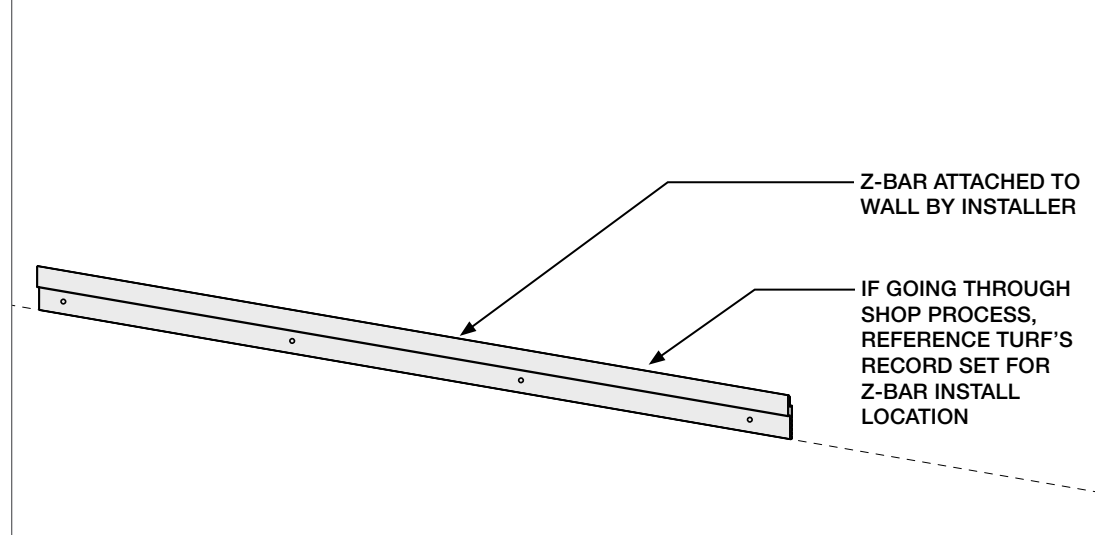

4 - MOUNT FIRST MONOLITH PANEL

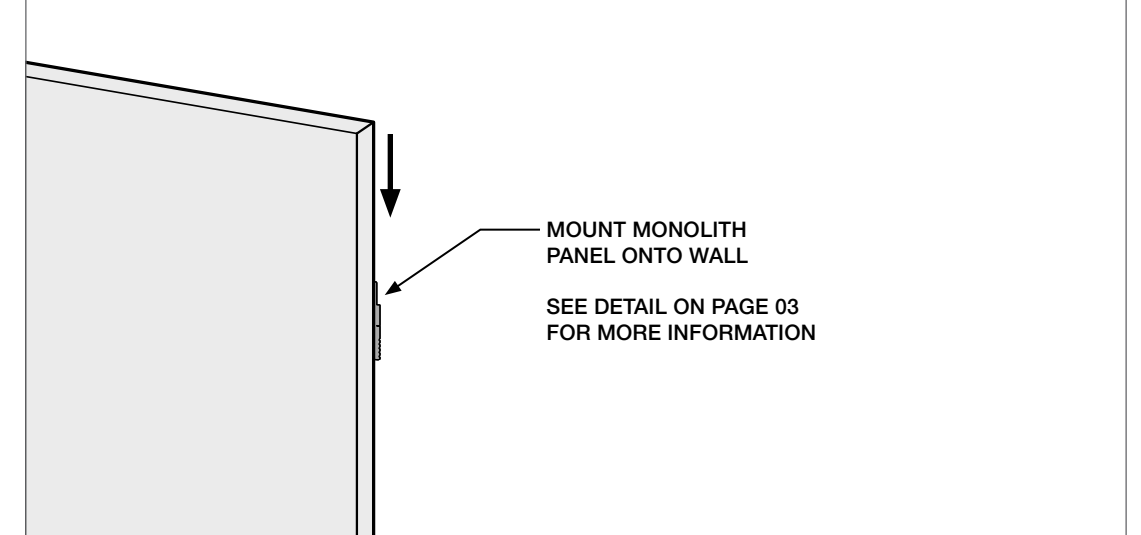

5 - APPLY REVEAL STRIP

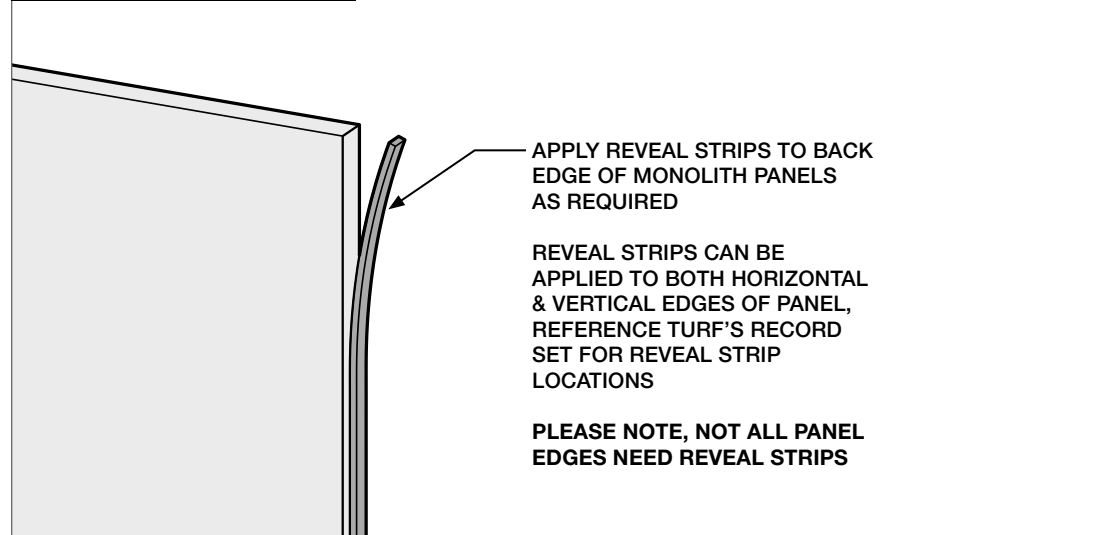

6 - MOUNT ADDITIONAL MONOLITH PANELS AS REQUIRED

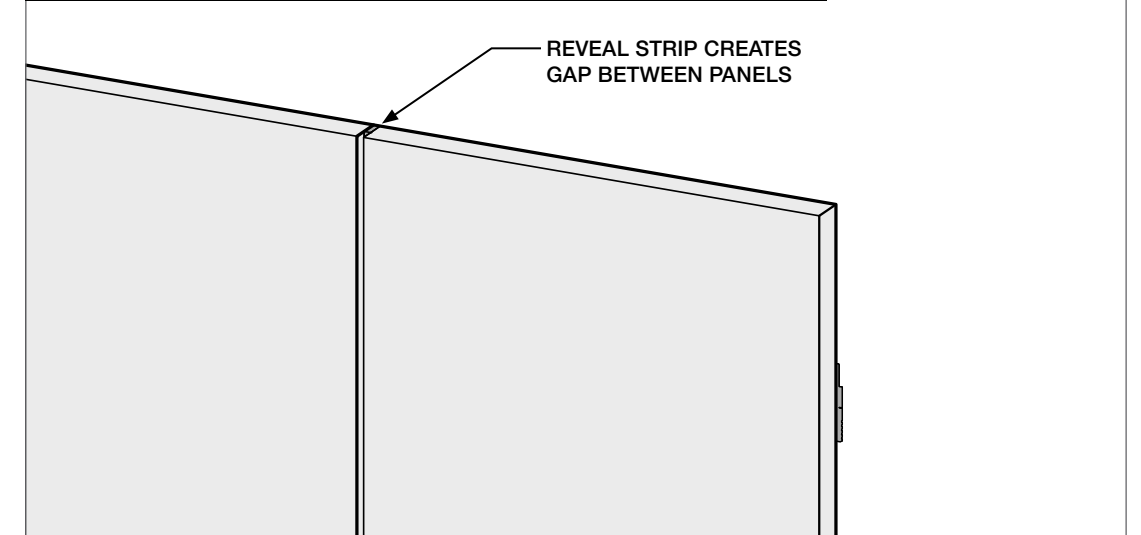

Trim Guide

Monolith panels are designed with field adjustments in mind — just follow this simple guide.

Tools Required

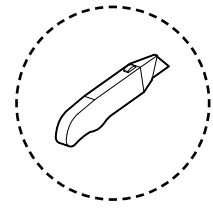

SHARP BLADE

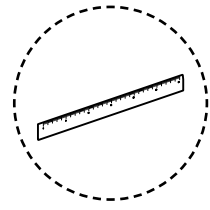

STRAIGHT EDGE

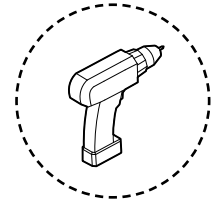

DRILL

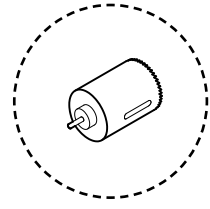

HOLE SAW

1 - TRIM PANEL HORIZONTALLY AS REQUIRED

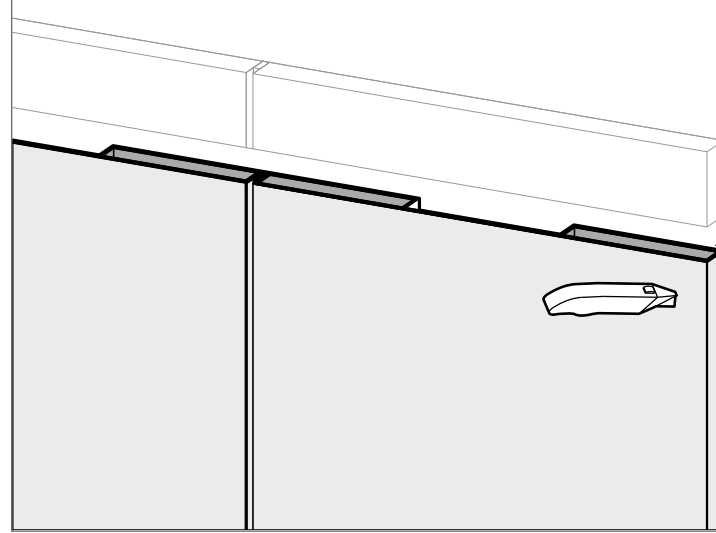

TRIM PANEL HORIZONTALLY AS REQUIRED TO ACCOMMODATE FIELD CONDITIONS, AVOID CUTTING WITHIN 1" OF Z-CLIP LOCATIONS

PLEASE NOTE, PANELS ARE HOLLOW AND CANNOT BE RECAPPED ONCE TRIMMED

2 - TRIM FLAT FILL AS REQUIRED

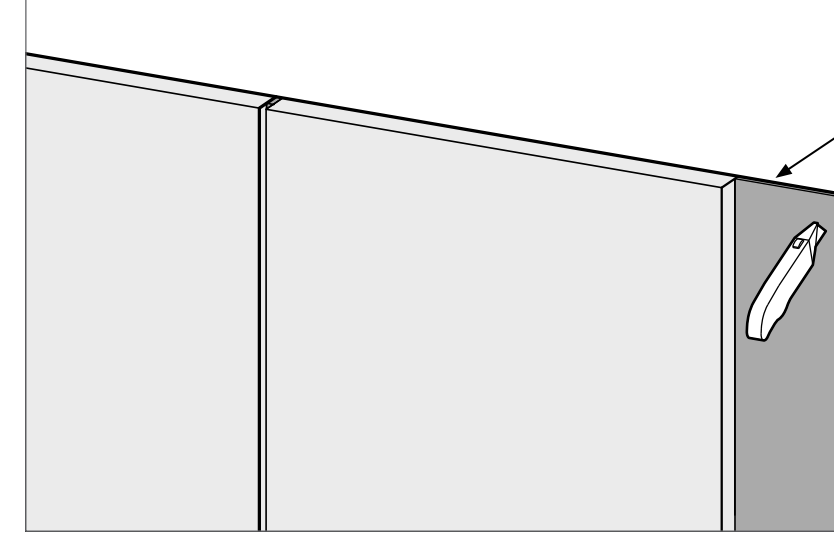

FOR WALL TO WALL INSTALLATIONS, SOME PROJECTS MAY CONTAIN FLAT FILL TO ACCOUNT FOR VARIANCE IN FIELD CONDITIONS
TRIM AS REQUIRED

3 - CUTTING HOLES FOR FIXTURES & EQUIPMENT

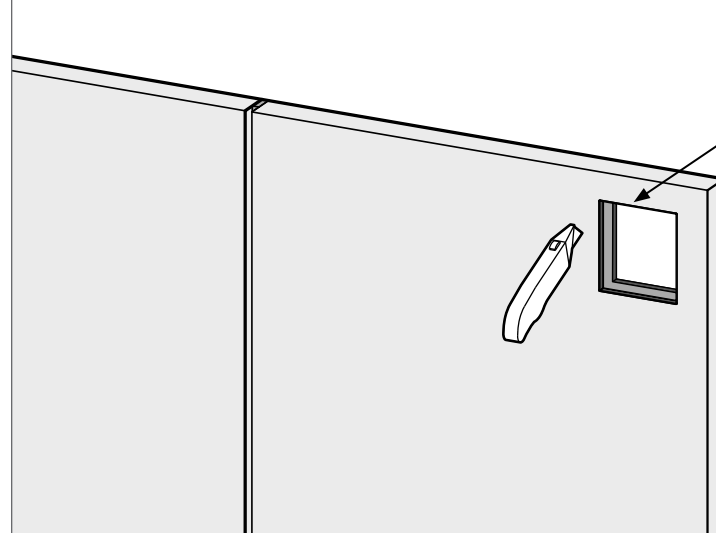

PANELS CAN BE CUT TO ACCOMMODATE FIXTURES & EQUIPMENT, AVOID CUTTING WITH 1" OF Z-CLIP LOCATIONS AND PANEL EDGE

TO CUT CIRCULAR HOLES, TURF RECOMMENDS USING A HOLE SAW IN REVERSE FOR A CLEANER EDGE

4 - DO NOT TRIM VERTICALLY ALONG PANEL

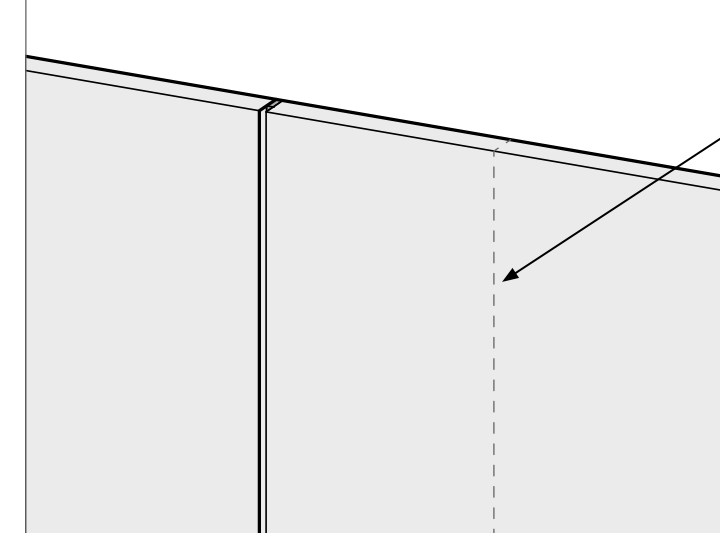

WARNING
DO NOT TRIM VERTICALLY THROUGH THE PANEL

TRIMMING VERTICALLY WILL COMPROMISE PANEL STABILITY



Tech

Acoustics	ASTM C423-17: Type A Mounting
Fire Rating	ASTM E-84 – Class A
VOC	ASTM D5116 Compliant

Details

Lead Time	Check the Turf website for current lead times.
Warranty	Five (5) years
Maintenance	Vacuum to remove any particulate matter and air-borne debris or dust. Compressed air can be used to dust the material in difficult to reach areas for large assemblies. Contact us for more information relative to spot cleaning.
Weight	Turf products cannot support the weight of any other items in field.

Acoustic Rating

NRC = 0.9

The rating above describes an array of similarly sized product, actual rating may vary depending on field conditions and arrangement. Official acoustic test reports will be available in Q3 of 2024.

Certifications

Declare.



Photo by Kendall McCaugherty, Hall+Merrick+McCaugherty

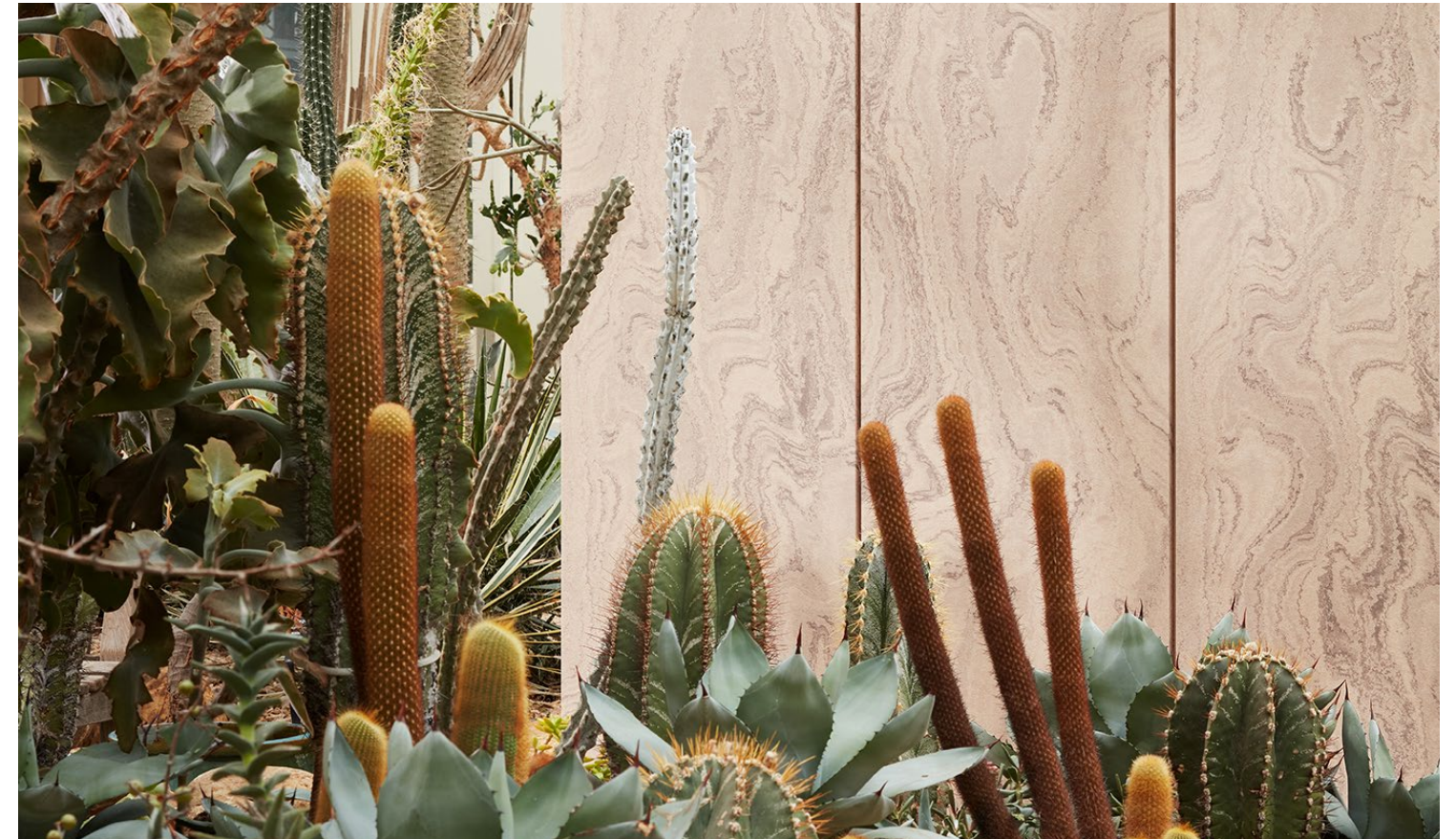

Photo by Kendall McCaugherty, Hall+Merrick+McCaugherty

9mm Colors

Introducing Hues, our new 9mm color palette designed for the senses.

The 9mm PET felt board is used as our primary construction material. Select one of our coordinating neutrals to blend in, or go for a contrasting element with one of our hues.

The process used to create PET felt often results in a heathered effect where multiple tones are present. Slight variations in color should be expected when using this sustainable material.

Felt Thickness
9mm +/-0.5 mm

Monitors and printers vary. Please request a material sample to verify felt colors.



10 TOPO GREEN



12 GRASSHOPPER



11 CELADON

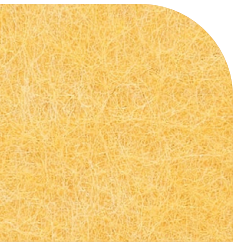

63 SAFFLOWER



64 PLANTAIN

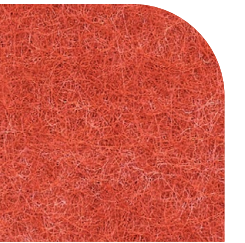

43 ORANGE CRUSH

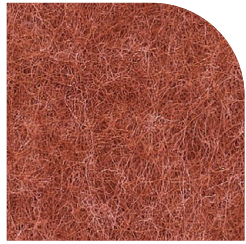

18 ULTISOL



17 BLUSH

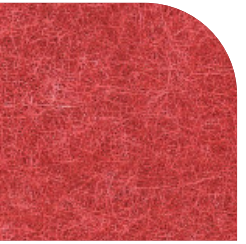

23 RED

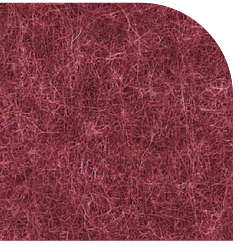

15 MERLOT

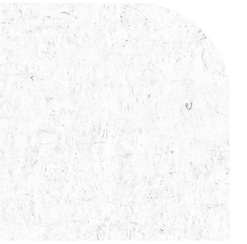

50 IVORY



33 LUMINARY



83 HOLLAND OATS



82 BARLEY



34 TONAL TAUPE



35 BARK

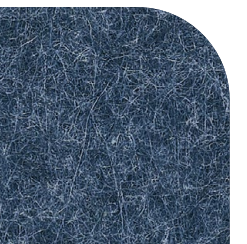

28 INDIGO

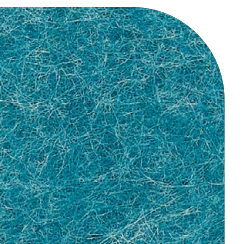

30 CYAN

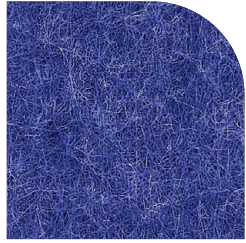

24 ROYAL BLUE

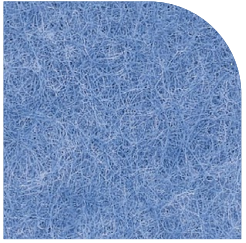

31 AZURE

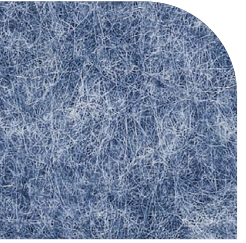

27 JEAN JACKET

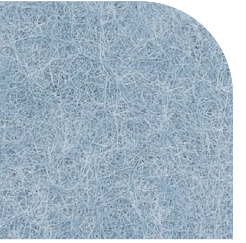

26 FADED DENIM

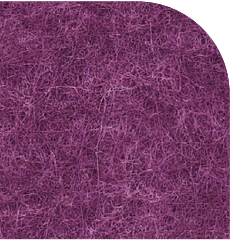

40 MAGENTA

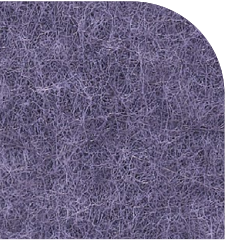

41 DRIED LAVENDER

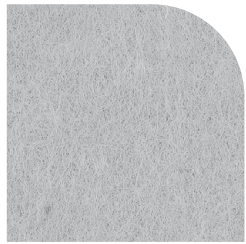

66 PEWTER



05 WHITE

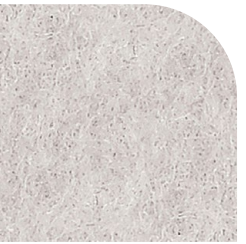

01 CREAM

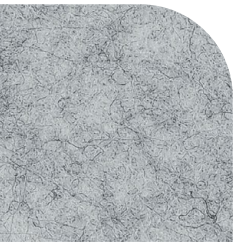

04 LIGHT GREY



98 STORM

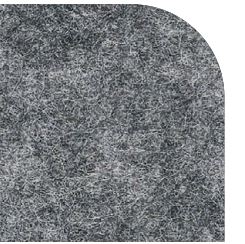

09 DAMASCUS

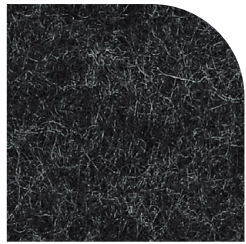

06 CHARCOAL



07 BLACK



9mm Wood Textures

Invite nature into your space with our wood-inspired textures. Digital printing on felt ensures a unique and realistic grain with virtually no repeats.

There is an additional product cost for Wood Textures.

Please note there is additional lead time for custom matching. Texture and customization will incur additional costs beyond our standard 9mm options.

Felt Thickness
9mm +/-0.5 mm

Monitors and printers vary.
Please request a material sample to verify felt colors.



D01 WHITE ASH



D02 SILVER TEAK



D03 CLEAR MAPLE



D04 WASHED ASH



D05 MEDIUM OAK



D06 PLANKED OAK

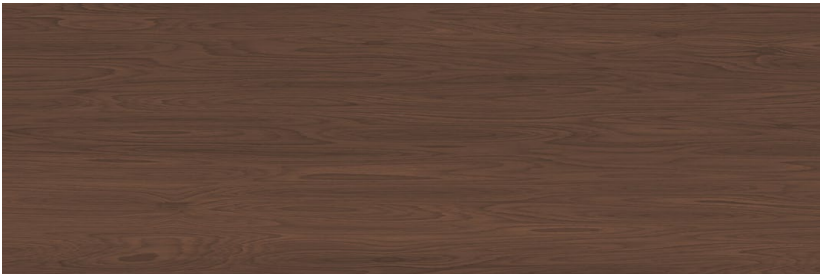

D07 DARK WALNUT



D08 BLACK PEAR

9mm Stone Textures

Inspired by nature, designed for felt. Our digitally printed Stone Textures capture the character and nuance of stone on top of a curated color collection from our Hues palette with virtually no repeats. The three patterns in this family each capture unique elements from the stones for which they are named.

There is an additional product cost for Stone Textures.

Turf has curated this collection to include only the best pattern and color combinations.

Felt Thickness
9mm +/-0.5 mm

Monitors and printers vary.
Please request a material sample to verify felt colors.



ST05 MARBLE



ST01 MARBLE

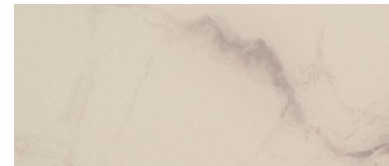

ST33 MARBLE

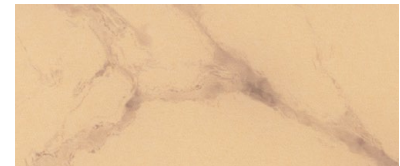

ST64 MARBLE



ST50 MARBLE



ST83 MARBLE

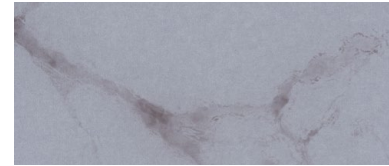

ST66 MARBLE

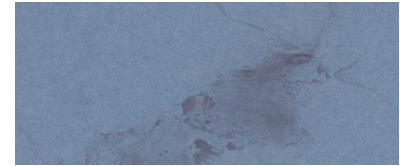

ST26 MARBLE



ST05 TRAVERTINE



ST01 TRAVERTINE

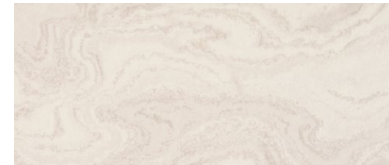

ST50 TRAVERTINE

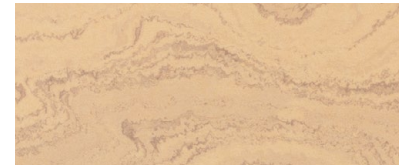

ST64 TRAVERTINE

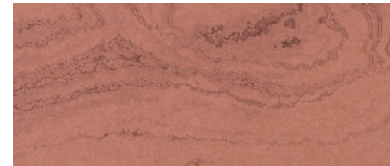

ST17 TRAVERTINE



ST83 TRAVERTINE



ST66 TRAVERTINE

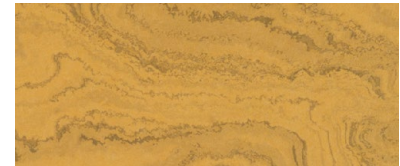

ST63 TRAVERTINE

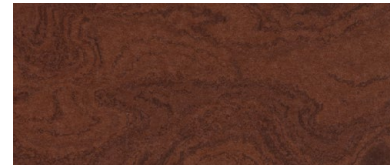

ST18 TRAVERTINE



ST34 TRAVERTINE

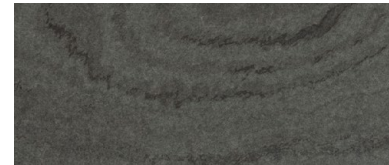

ST11 TRAVERTINE



ST26 TRAVERTINE

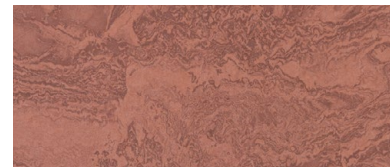

ST17 GRANITE



ST34 GRANITE

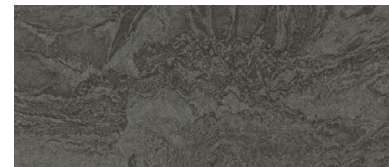

ST11 GRANITE



ST63 GRANITE

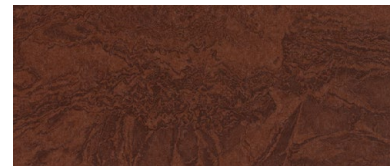

ST18 GRANITE

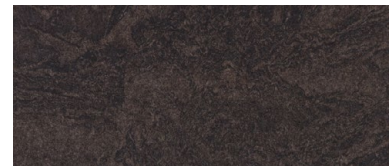

ST35 GRANITE

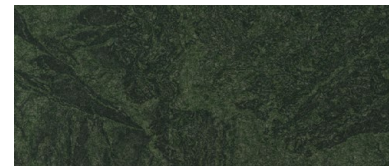

ST10 GRANITE

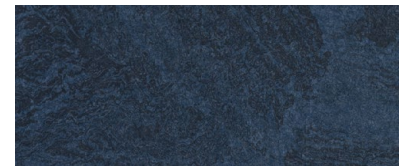

ST28 GRANITE

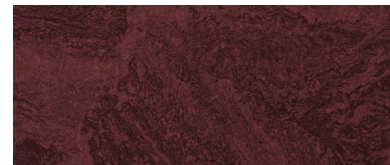

ST15 GRANITE

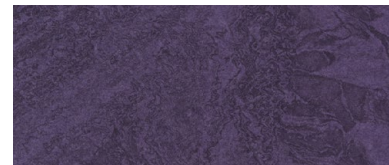

ST41 GRANITE



ST40 GRANITE