

MOTOR FRAMES:  
254TC-256TC

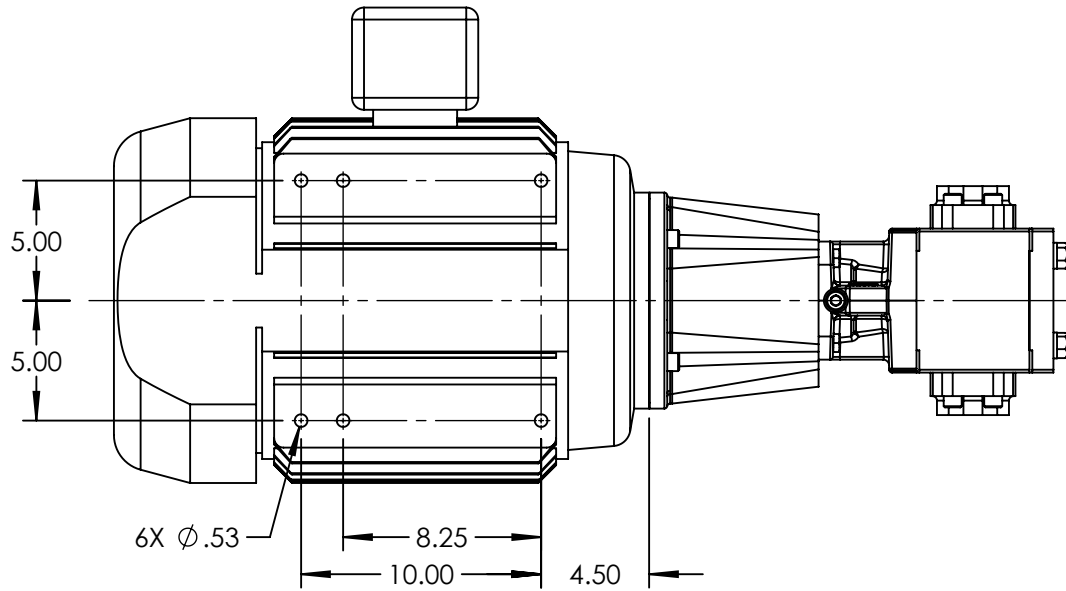
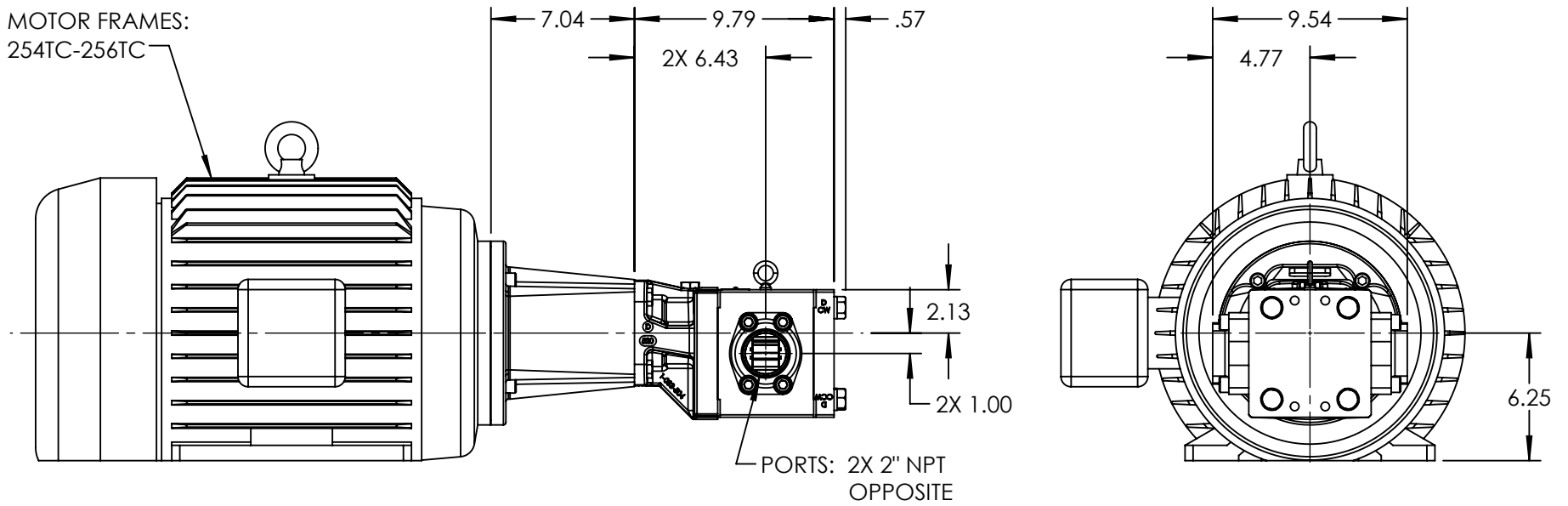

STANDARD MODELS: GB-41013-G00-M, GB-41013-G10-M

NOTES:

1. ALL DIMENSIONS ARE FOR REFERENCE ONLY.

STATE	Released	07/16/2021
DRAWN	bmanternach	6/22/2021
CHECKED	JAG	07/16/2021

DIMENSIONS ARE IN INCHES
PROJECT: E331
WAS:



VIKING PUMP, INC.  
A Unit of IDEX Corporation  
Cedar Falls, IA 50613  
U.S.A.

THIS DRAWING IS THE PROPERTY OF  
VIKING PUMP, INC. AND IS PROPRIETARY  
IN GENERAL AND DETAIL. IT SHALL NOT BE  
COPIED OR ITS CONTENTS REVEALED TO  
OUTSIDE PARTIES WITHOUT THE WRITTEN  
CONSENT OF VIKING PUMP, INC.

3D

DWG. NO. SHEET 1 OF 1  
GPV-1013-040-U

REV. A.0  
07/16/2021