

GENERAL ARRANGEMENT DETAILS

PUMP INFORMATION

PUMP MODEL	REVOLUTION - TWIN WING R0180P/14
INLET CONNECTION	1.5" DIN 11851 Male
OUTLET CONNECTION	1.5" DIN 11851 Male
SPECIAL FEATURES	NONE

THIS IS NOT A CERTIFIED DRAWING, USE FOR GENERAL INSTALLATION ONLY

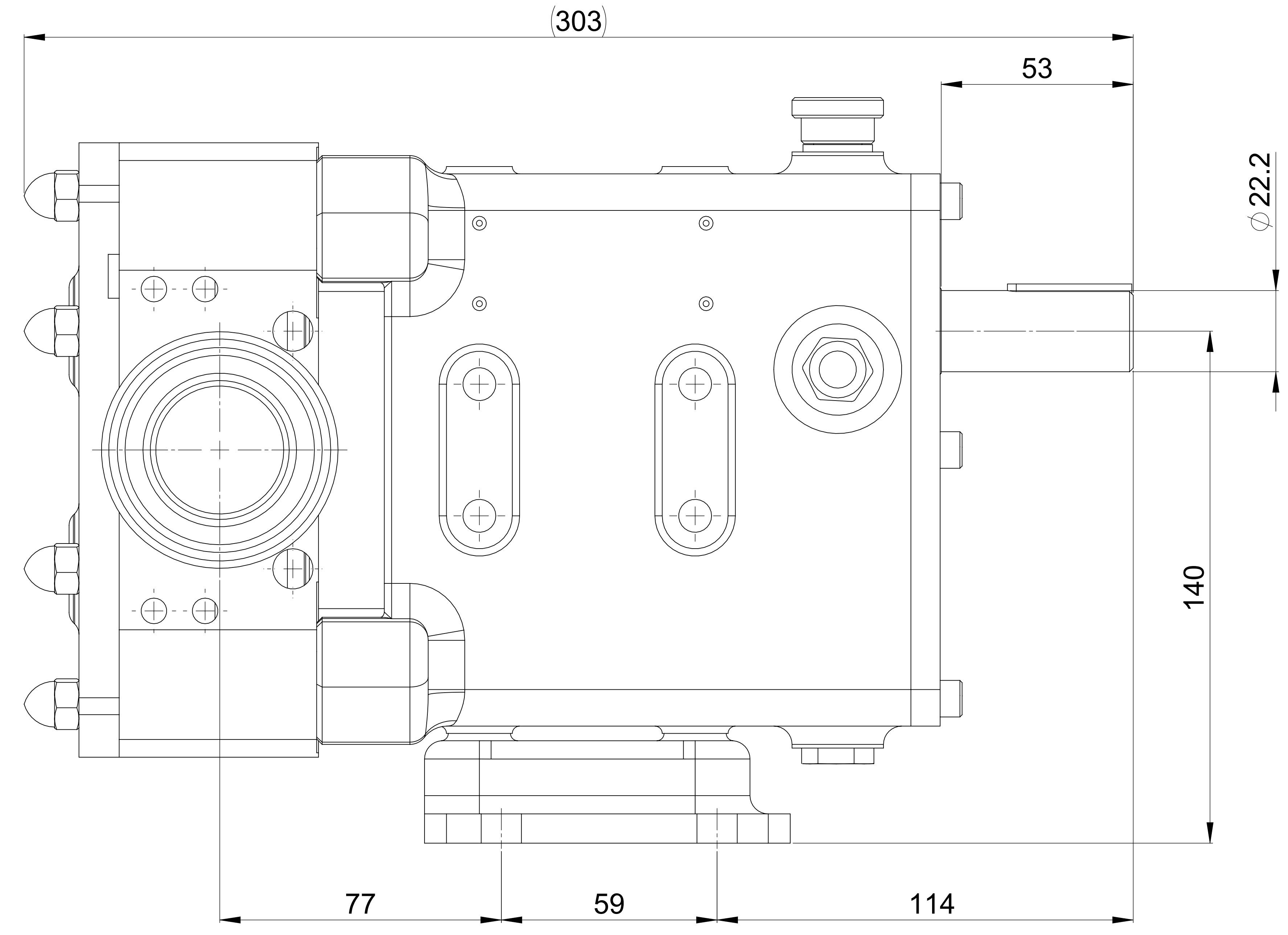
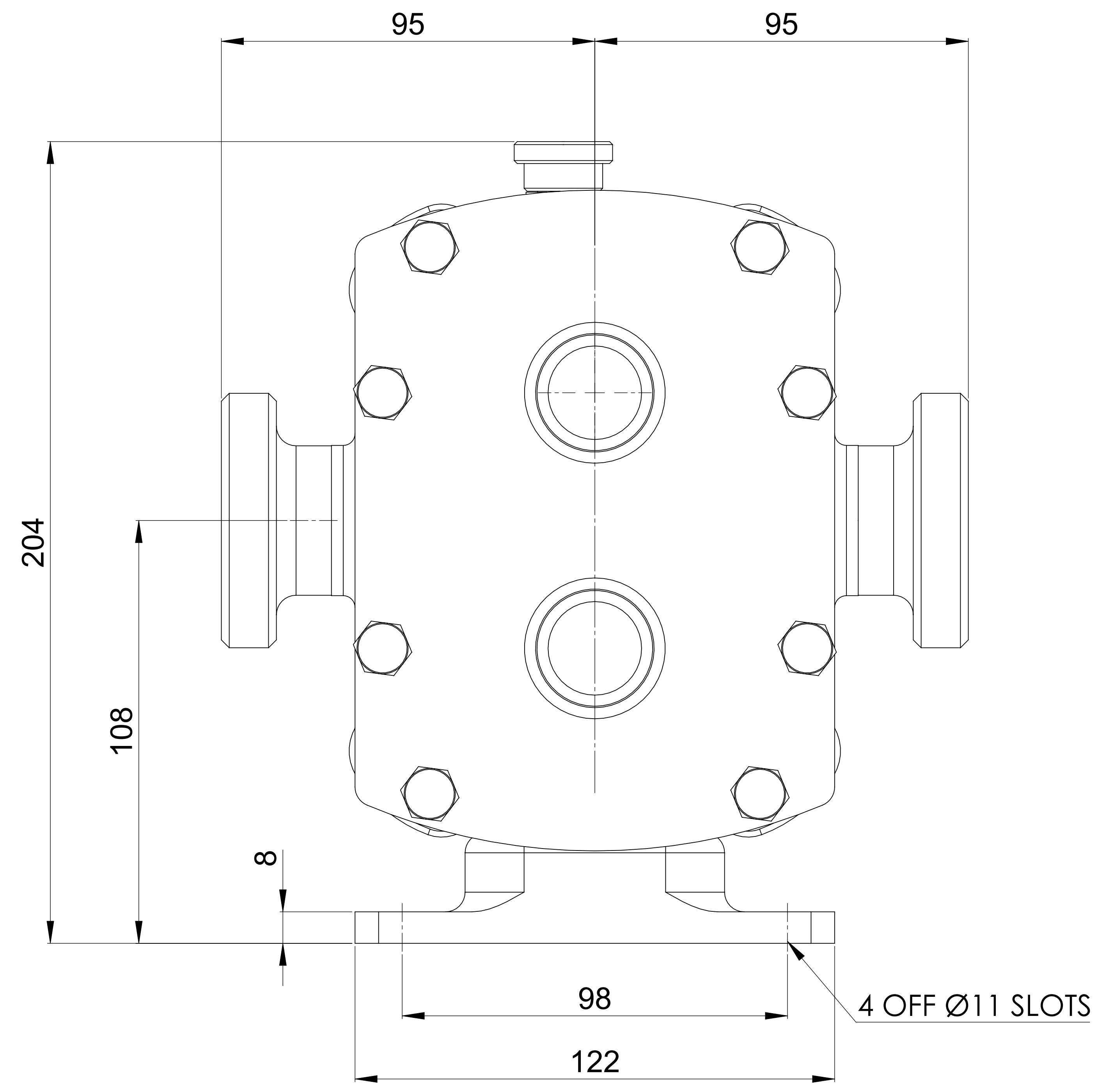
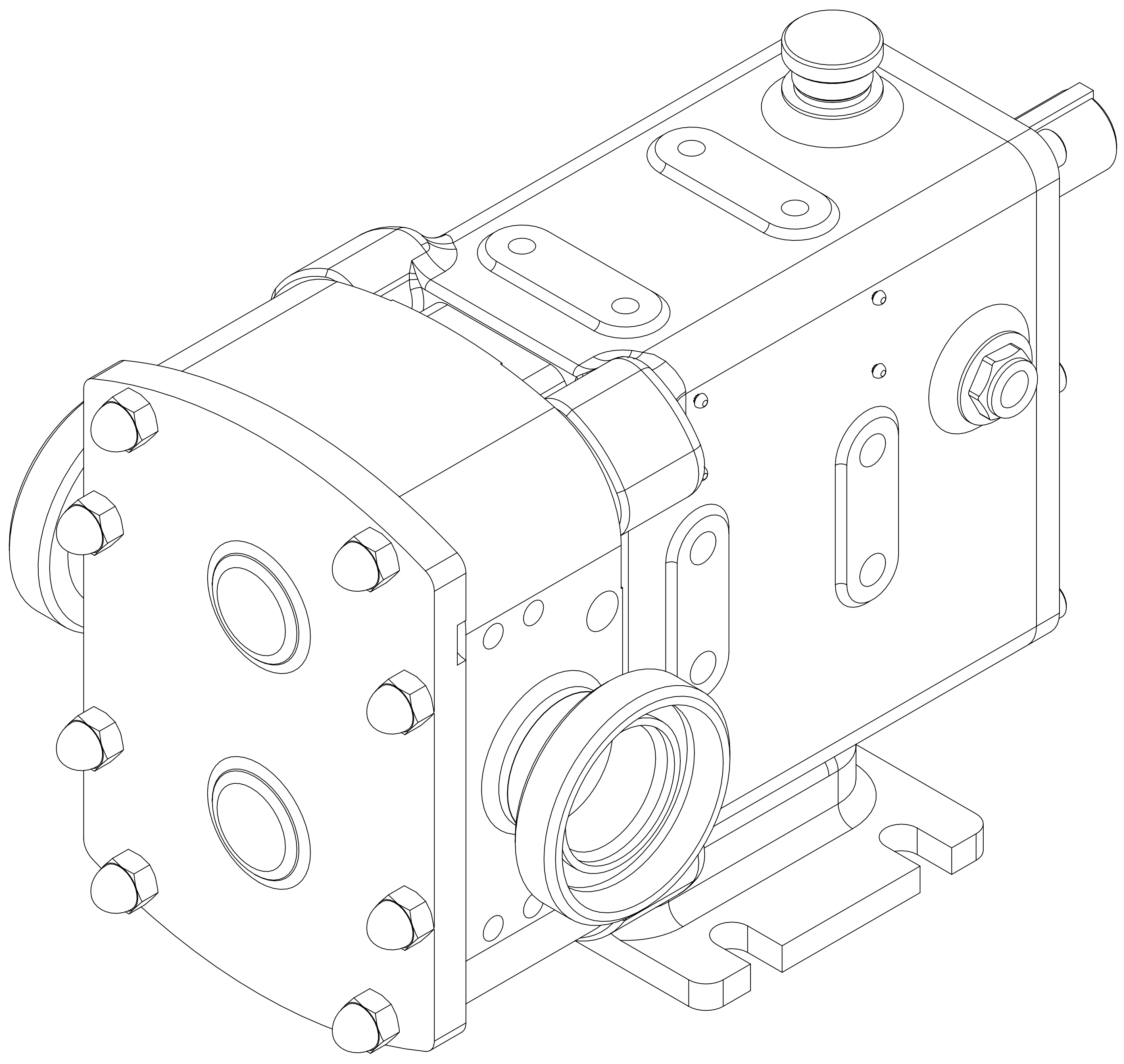

ISSUED	A	13/05/2019
AMENDMENT	ISSUE	DATE

wright flow
TECHNOLOGIES
 HIGHFIELD INDUSTRIAL ESTATE,
 EASTBOURNE,
 EAST SUSSEX, BN23 6PT
 TEL: (+44) 1323 509211

COPYRIGHT:
 THIS DRAWING IS THE SOLE
 PROPERTY OF
WRIGHT FLOW TECHNOLOGIES LTD.
 IT MUST NOT BE COPIED OR USED
 IN PART OR FULL WITHOUT PRIOR
 WRITTEN CONSENT.

UNLESS OTHERWISE STATED:
 ALL DIMENSIONS ± 2.50
 ANGLES ± 2.0°
 DO NOT SCALE THIS DRAWING
 REMOVE BURRS AND SHARP EDGES
 DIMENSIONS IN MILLIMETRES
IF IN DOUBT ASK

PROJECTION	DRAWN	CHECKED
	DSB	IPJB

TITLE:	GENERAL ARRANGEMENT
DRG. NO:	GA4171