

MOTOR FRAME	A	B	C	D	E	F
63	1.97 [50.0]	3.94 [100.0]	2.48 [63.0]	1.57 [40.0]	3.15 [80.0]	.28 [7.0]
71	2.20 [56.0]	4.41 [112.0]	2.80 [71.0]	1.77 [45.0]	3.54 [90.0]	.28 [7.0]
80	2.46 [62.5]	4.92 [125.0]	3.15 [80.0]	1.97 [50.0]	3.94 [100.0]	.39 [10.0]

B14 FLANGE ONLY

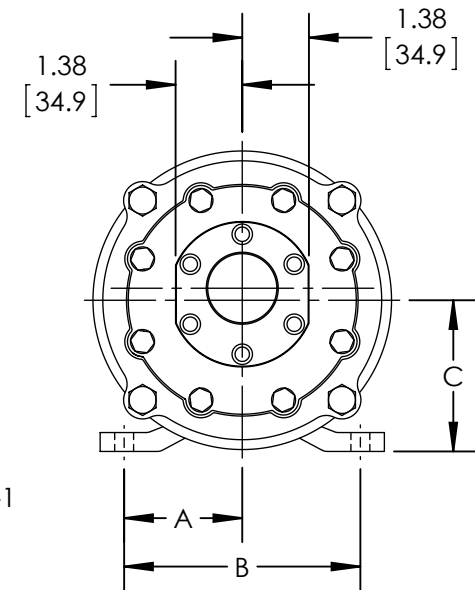
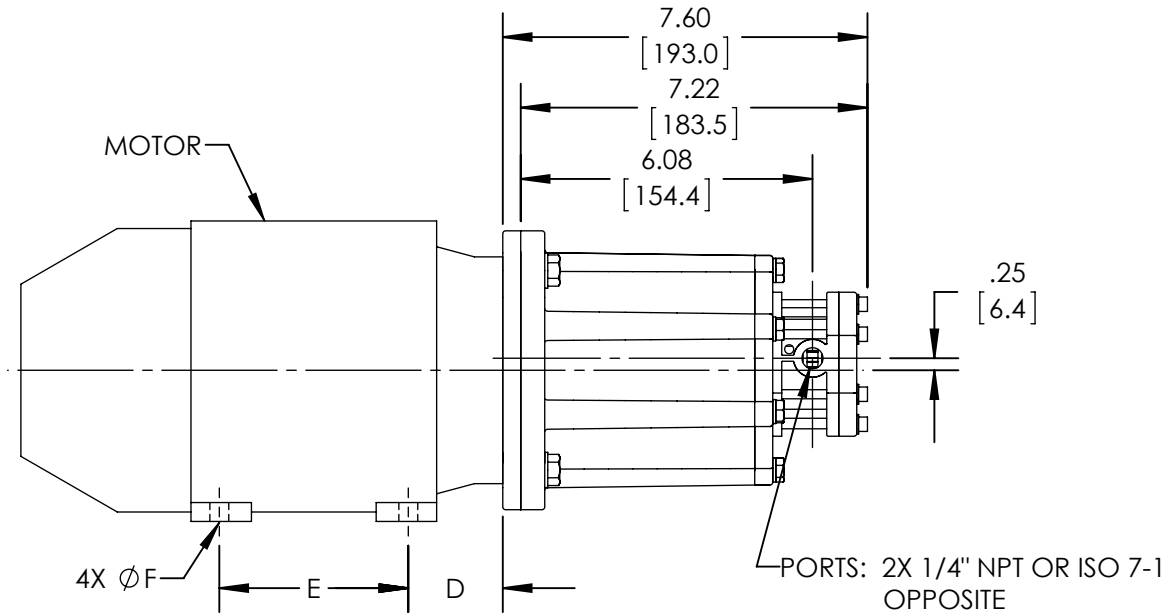
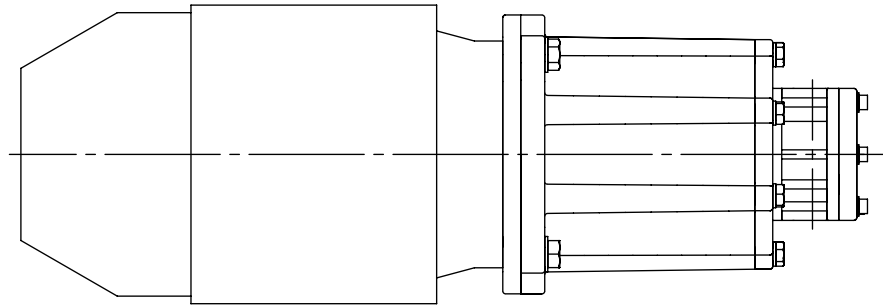

STANDARD MODEL: CMD-E02-M

STATE	Released	08/22/2012
DRAWN	bmanernach	8/7/2012
CHECKED	JDP	08/21/2012

DIMENSIONS ARE IN INCHES
PROJECT:
WAS:



VIKING PUMP, INC.
A Unit of IDEX Corporation
Cedar Falls, IA 50613
U.S.A.

THIS DRAWING IS THE PROPERTY OF VIKING PUMP, INC. AND IS PROPRIETARY IN GENERAL AND DETAIL. IT SHALL NOT BE COPIED OR ITS CONTENTS REVEALED TO OUTSIDE PARTIES WITHOUT THE WRITTEN CONSENT OF VIKING PUMP, INC.

2D

DWG. NO.
CMD-E02-2

SHEET 1 OF 1

REV. A.0

08/22/2012