

VIEW A-A

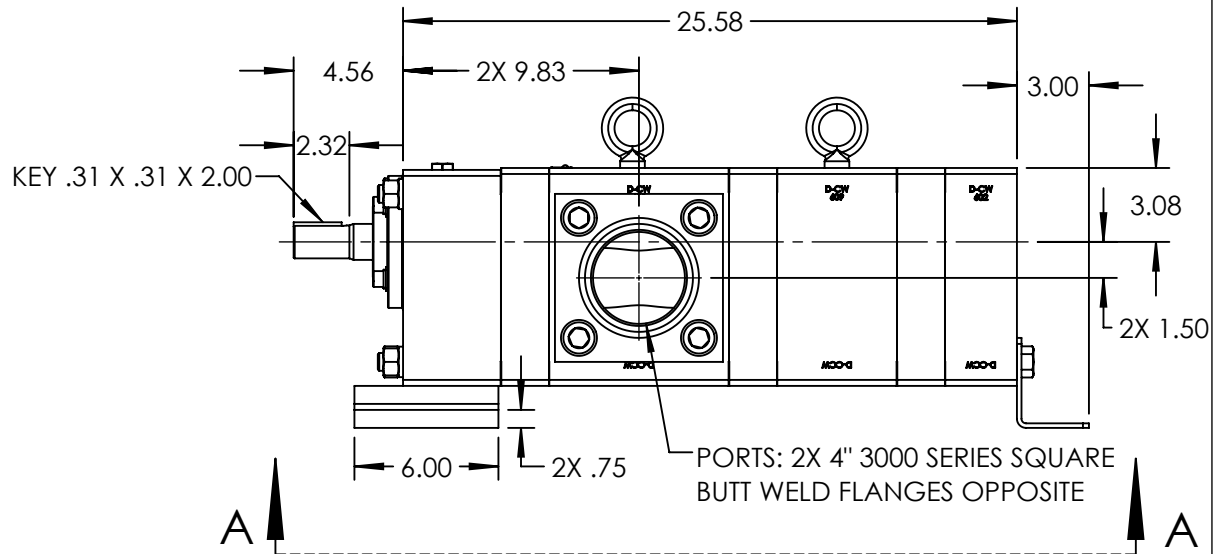
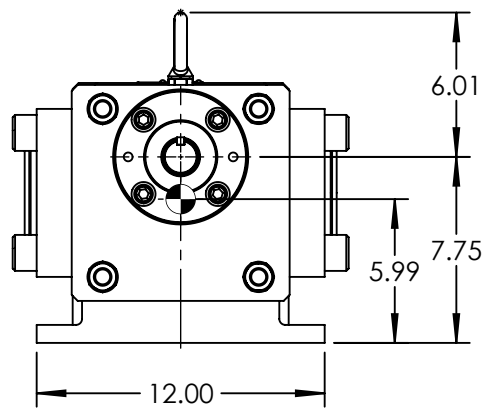

NOTES:

1. ALL DIMENSIONS ARE FOR REFERENCE ONLY.

MODELS: GP-41460-G00, GP-41460-G10

STATE	Released	10/08/2019
DRAWN	DLende	11/7/2017
CHECKED	JDP	10/07/2019

DIMENSIONS ARE IN INCHES
PROJECT: E251
WAS:



VIKING PUMP, INC.
A Unit of IDEX Corporation
Cedar Falls, IA 50613
U.S.A.

THIS DRAWING IS THE PROPERTY OF VIKING PUMP, INC. AND IS PROPRIETARY IN GENERAL AND DETAIL. IT SHALL NOT BE COPIED OR ITS CONTENTS REVEALED TO OUTSIDE PARTIES WITHOUT THE WRITTEN CONSENT OF VIKING PUMP, INC.

3D

DWG. NO.	SHEET 1 OF 1
GPV-1460-023-U	

REV. C.0
10/08/2019