

VIEW A-A

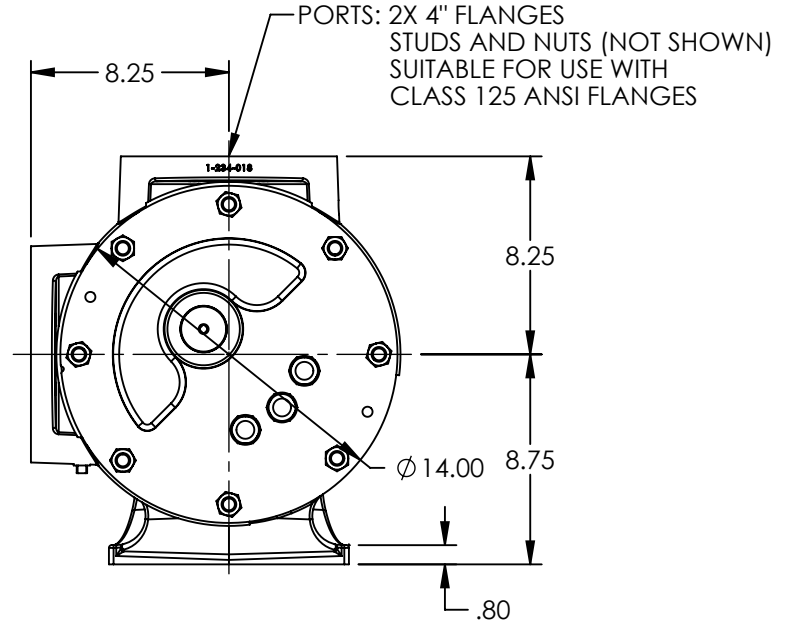
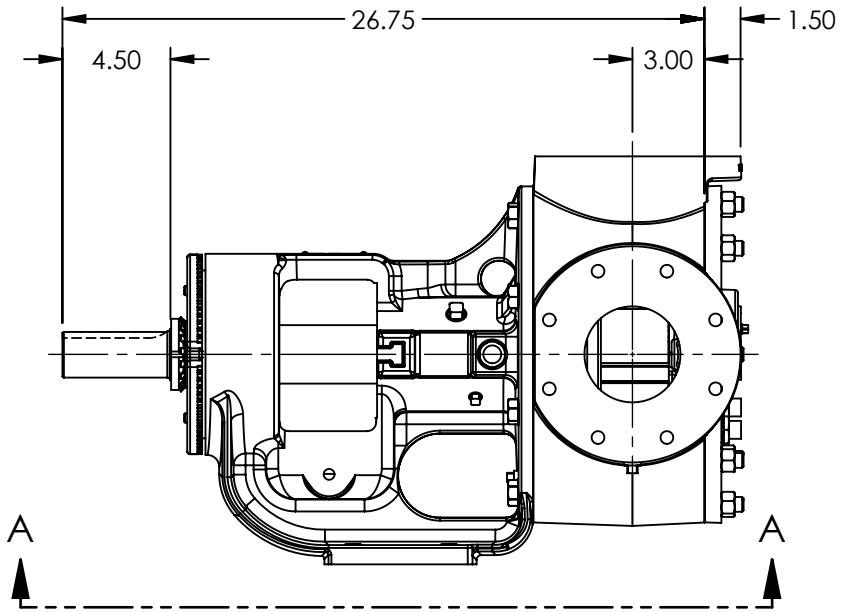

- NOTES:
 1. HEATER CONDUIT HIDDEN FOR CLARITY.
 2. ALL DIMENSIONS ARE FOR REFERENCE ONLY.

STANDARD MODEL: Q124E

STATE	Released	06/19/2019
DRAWN	tdutcher	05/17/2011
CHECKED	SJJ	06/19/2019

DIMENSIONS ARE IN INCHES
 PROJECT: D380
 WAS:



VIKING PUMP, INC.
 A Unit of IDEX Corporation
 Cedar Falls, IA 50613
 U.S.A.

THIS DRAWING IS THE PROPERTY OF VIKING PUMP, INC. AND IS PROPRIETARY IN GENERAL AND DETAIL. IT SHALL NOT BE COPIED OR ITS CONTENTS REVEALED TO OUTSIDE PARTIES WITHOUT THE WRITTEN CONSENT OF VIKING PUMP, INC.

3D

DWG. NO. QV-1984

SHEET 1 OF 1

REV. E.0
 06/19/2019