

MOTOR FRAMES:
213TC-215TC

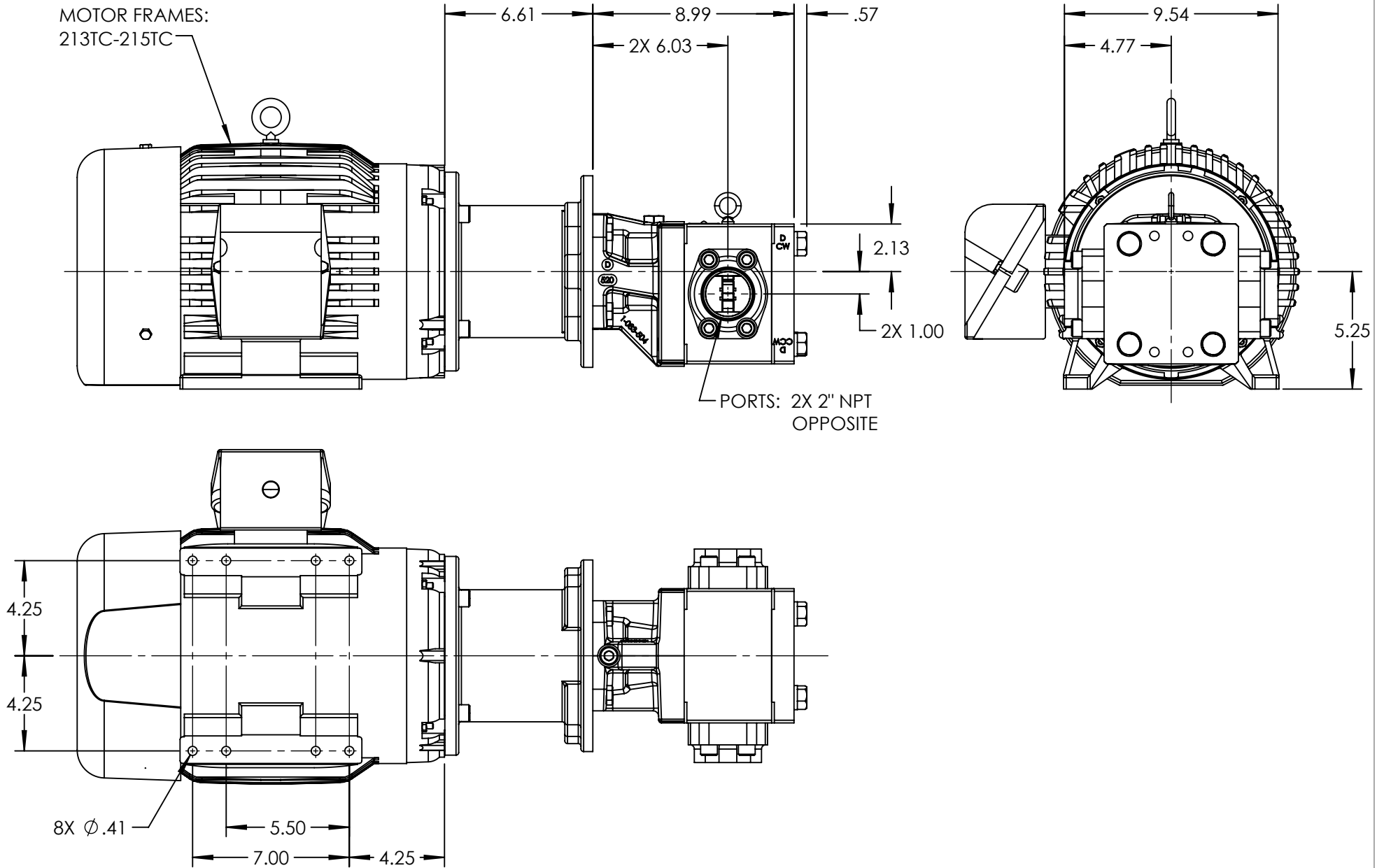

PORTS: 2X 2" NPT
OPPOSITE

NOTES:

1. ALL DIMENSIONS ARE FOR REFERENCE ONLY.

STANDARD MODELS: GB-41005-G00-M, GB-41005-G10-M

STATE	Released	07/16/2021
DRAWN	bmanternach	6/21/2021
CHECKED	JAG	07/16/2021

DIMENSIONS ARE IN INCHES
PROJECT: E331
WAS:



VIKING PUMP, INC.
A Unit of IDEX Corporation
Cedar Falls, IA 50613
U.S.A.

THIS DRAWING IS THE PROPERTY OF
VIKING PUMP, INC. AND IS PROPRIETARY
IN GENERAL AND DETAIL. IT SHALL NOT BE
COPIED OR ITS CONTENTS REVEALED TO
OUTSIDE PARTIES WITHOUT THE WRITTEN
CONSENT OF VIKING PUMP, INC.

3D

DWG. NO. GPV-1005-003-U
SHEET 1 OF 1

REV. A.0
07/16/2021