

PUMP MODEL	TRA10-0600
ORIENTATION	VERTICAL
COVER	STANDARD
INLET	2.5" TRI-CLAMP
DISCHARGE	2.5" TRI-CLAMP
SPECIALS	NONE

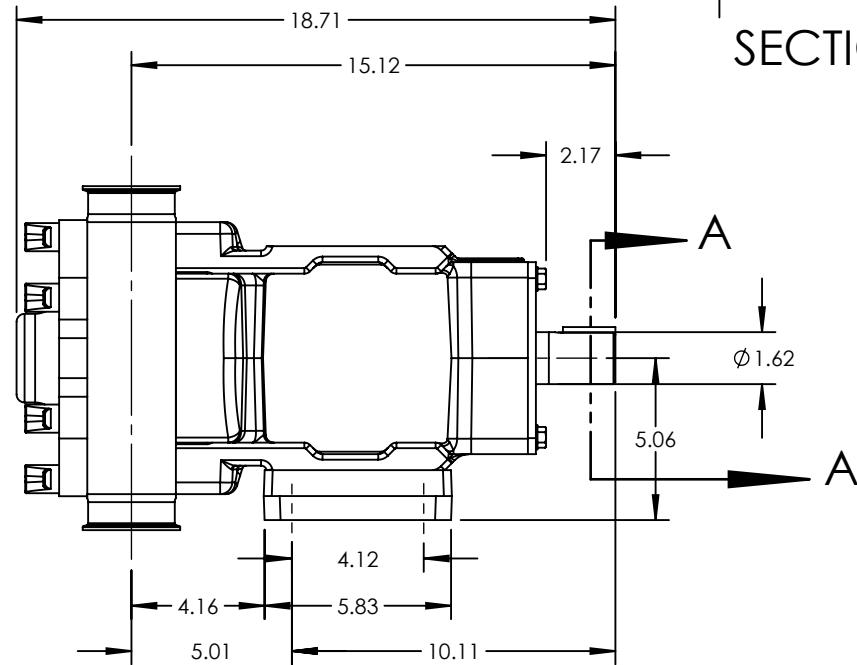

NOTES:
1. THIS IS NOT A CERTIFIED DRAWING. USE FOR GENERAL INSTALLATION ONLY.

STATE	Released	04/20/2022	DIMENSIONS ARE IN INCHES
DRAWN	cneff	8/9/2013	
CHECKED	CJM	04/20/2022	
PROJECT:			WAS:
WAS:			

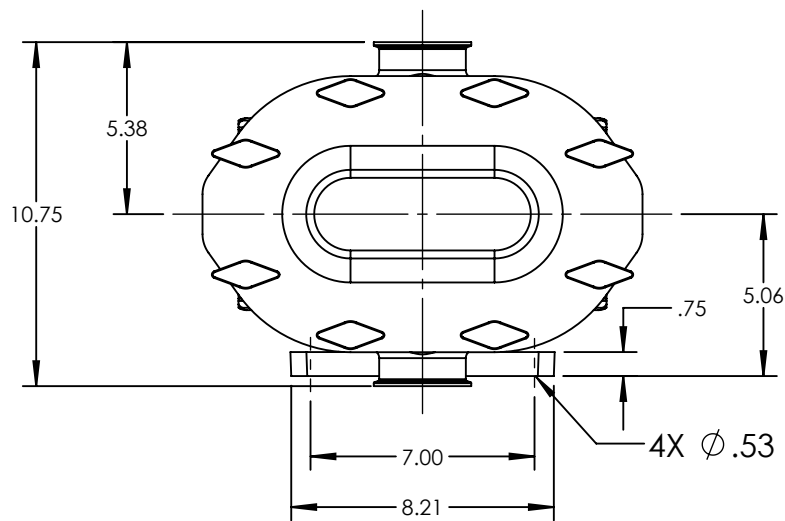
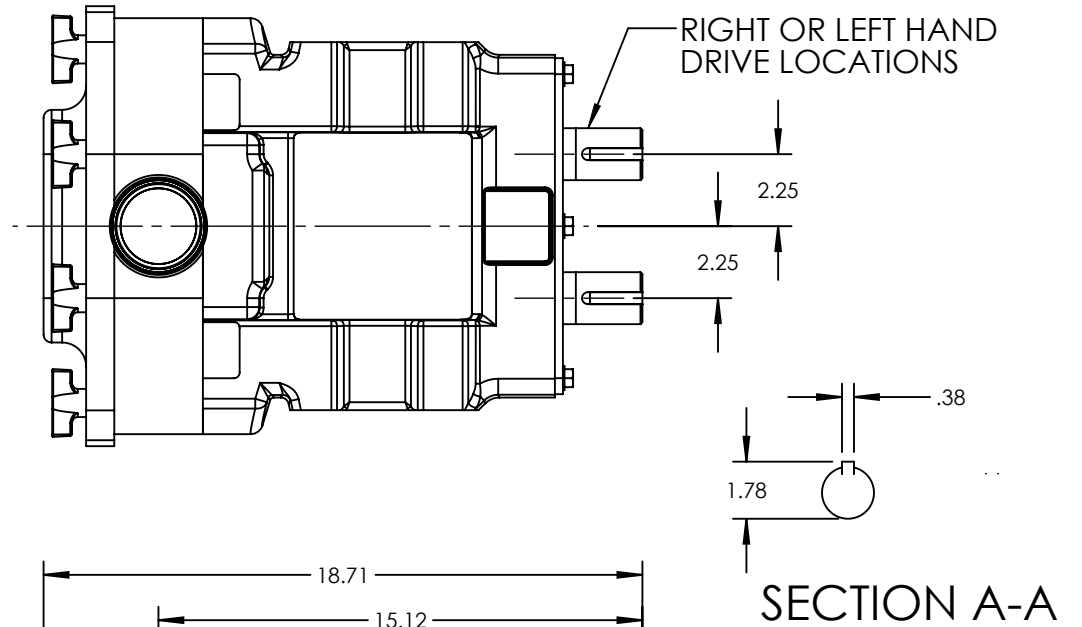

VIKING PUMP, INC.
A Unit of IDEX Corporation
Cedar Falls, IA 50613 U.S.A.
VIKINGPUMP.COM

THIS DRAWING IS THE PROPERTY OF VIKING PUMP, INC. AND IS PROPRIETARY IN GENERAL AND DETAIL. IT SHALL NOT BE COPIED OR ITS CONTENTS REVEALED TO OUTSIDE PARTIES WITHOUT THE WRITTEN CONSENT OF VIKING PUMP, INC.

3D

DWG. NO. TRA10-0600-002
SHEET 1 OF 1

REV. B.1

04/20/2022