

SEVEN[®] CONTINENTS

where expert manufacturing meets great design





SEVEN CONTINENTS is a full service retail solution provider.

Building on over 40 years of established capabilities, smart design and expert fabrication, our “one-stop-shop” is here at every stage of development: From collaborative ideation and design to expert manufacturing – all delivered on time.



OUR PRODUCTS include:

- MANNEQUINS + FORMS
- FIXTURES + FURNITURE
- POP-UPS + POP-IN INSTALLATIONS
- IN-CASE + TOP OF COUNTER PROGRAMS
- SIGNAGE + SIGNHOLDERS + BRANDING
- DECORATIVES + DISPLAYERS

...and more!



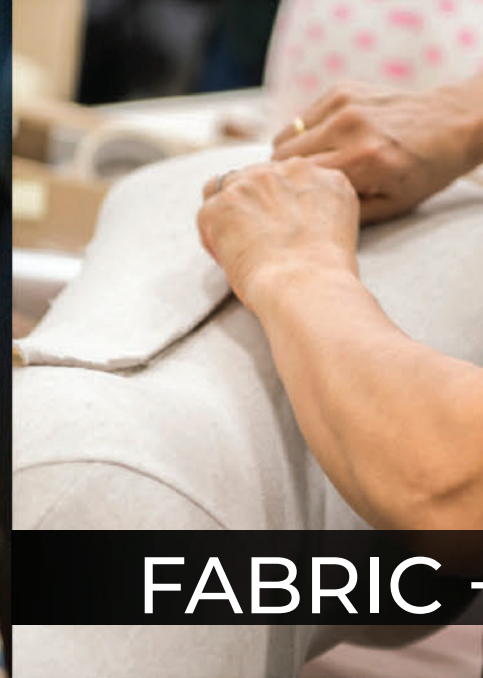

BLOW MOLDING

FABRIC + UPHOLSTERY



DESIGN + BUILD + INSTALL

METAL + WOOD FABRICATION



SPECIALIZED MATERIALS + SOURCING

FINISHING

CASTING

MANUFACTURING + INTERNATIONAL DISTRIBUTION



Our local network

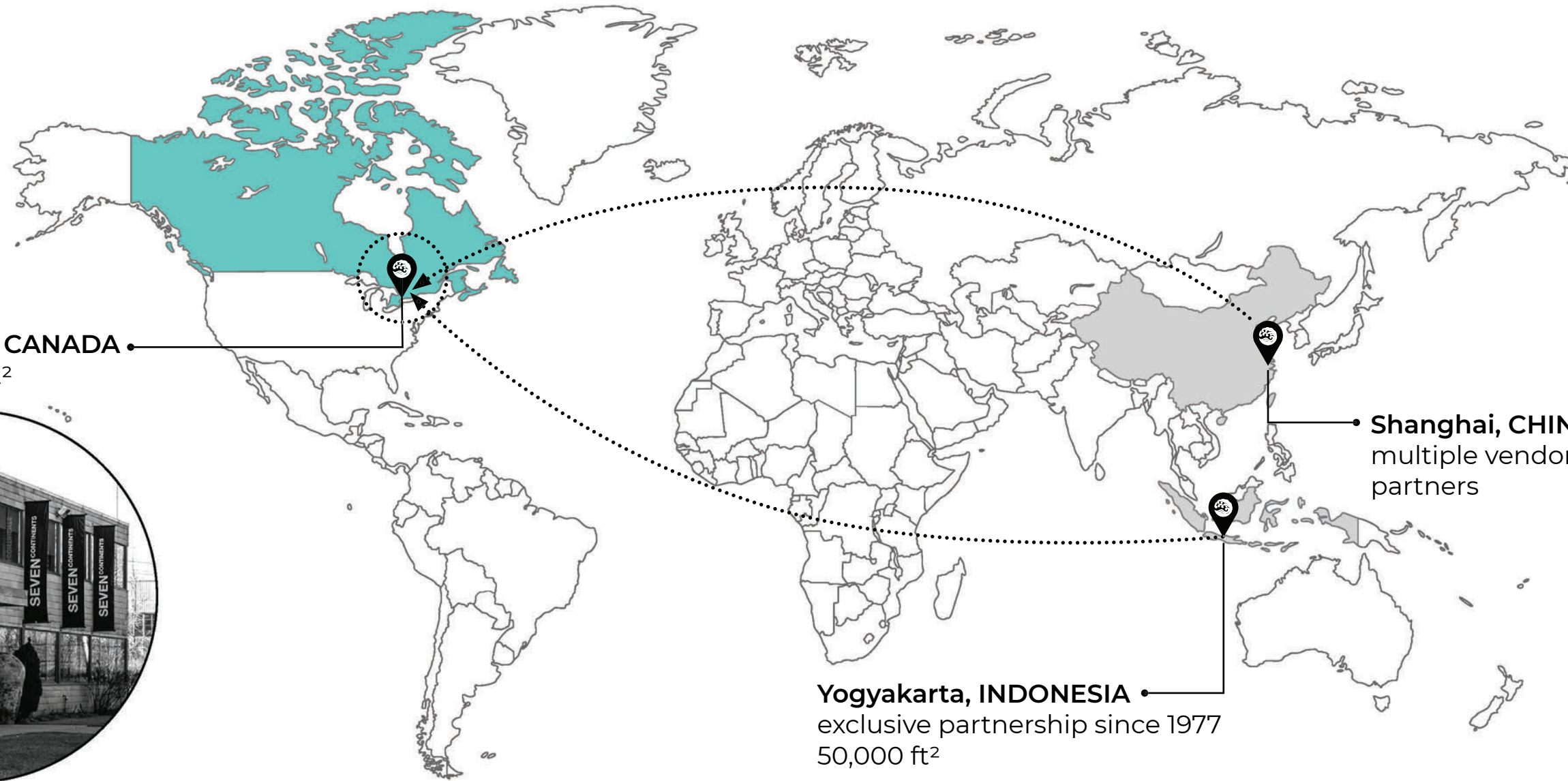

Our global partners



TORONTO

- home office founded in 1977
- in-house production + warehouse
- customer service + design studio
- vertically integrated manufacturing
- trusted local vendor partnerships over 40 years
- distribution management + on-site installation options available



MANUFACTURING + INTERNATIONAL DISTRIBUTION



Here at every stage...

CLIENT CONSULTATION

Toronto, CANADA
70,000 ft²



TORONTO

- SALES + ACCOUNT MANAGEMENT
- COLLABORATIVE DESIGN
- SOURCING
- SAMPLES + PROTOTYPING
- EXTENDED VENDOR NETWORK
- PRODUCTION
- QUALITY CONTROL
- PACKAGING + DISTRIBUTION

**FULL SERVICE
IN-HOUSE CAPABILITIES**

...from ideation
to delivery.

DELIVERY VIA:

- SEA
- GROUND
- AIR



OUR CAPABILITIES



Toronto, CANADA in-house: blow molding · 3D printing · metal + wood fabrication · upholstery · finishing · packaging + distribution

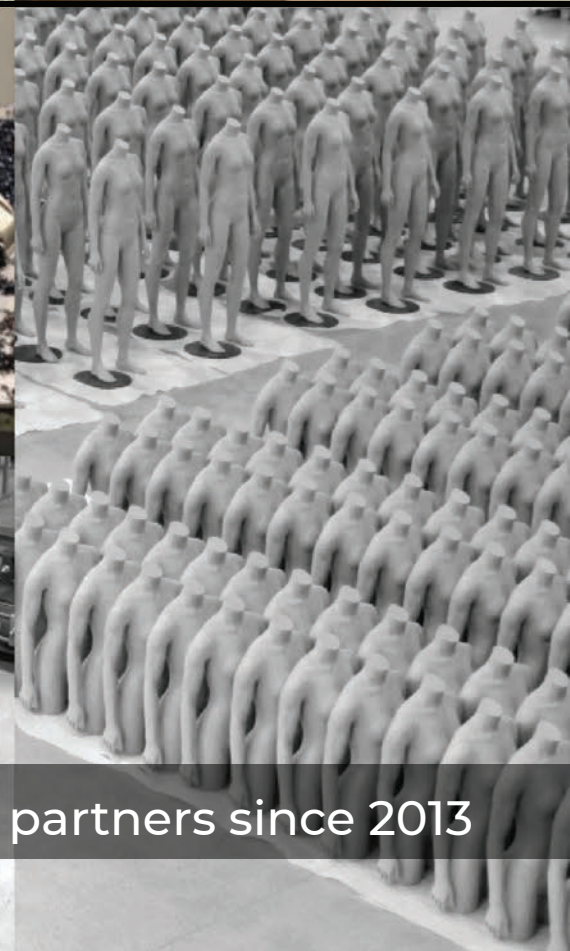

Yogyakarta, INDONESIA exclusive partnership since 1977

Shanghai, CHINA multiple vendor partners since 2013

BLOW MOLDING: MADE TO BE MADE AGAIN

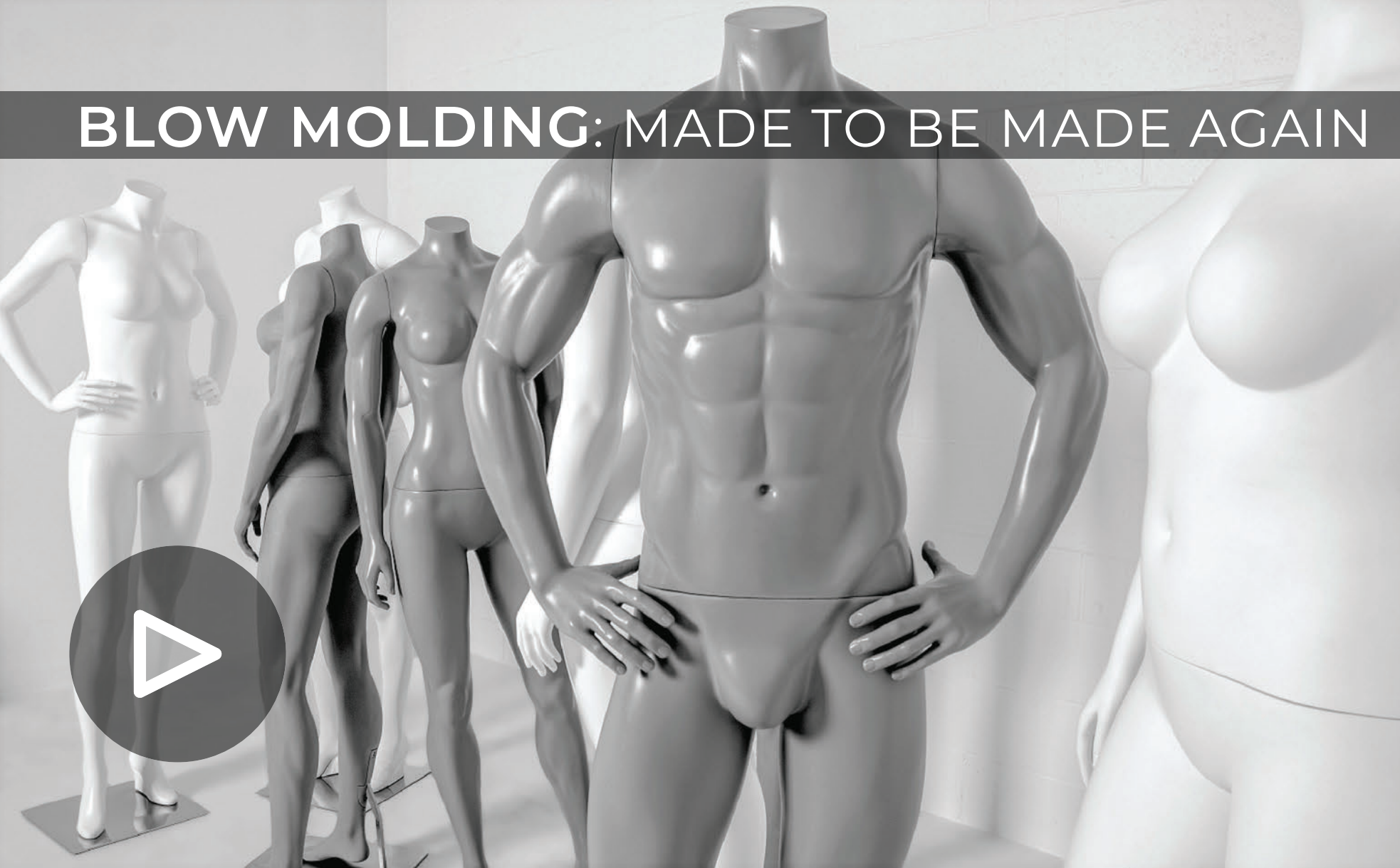

- Zero Maintenance
- 100% recyclable
- Lightweight
- Infused Color (no paint)
- Dramatically durable
- Hi-speed local production
- Anti-microbial material

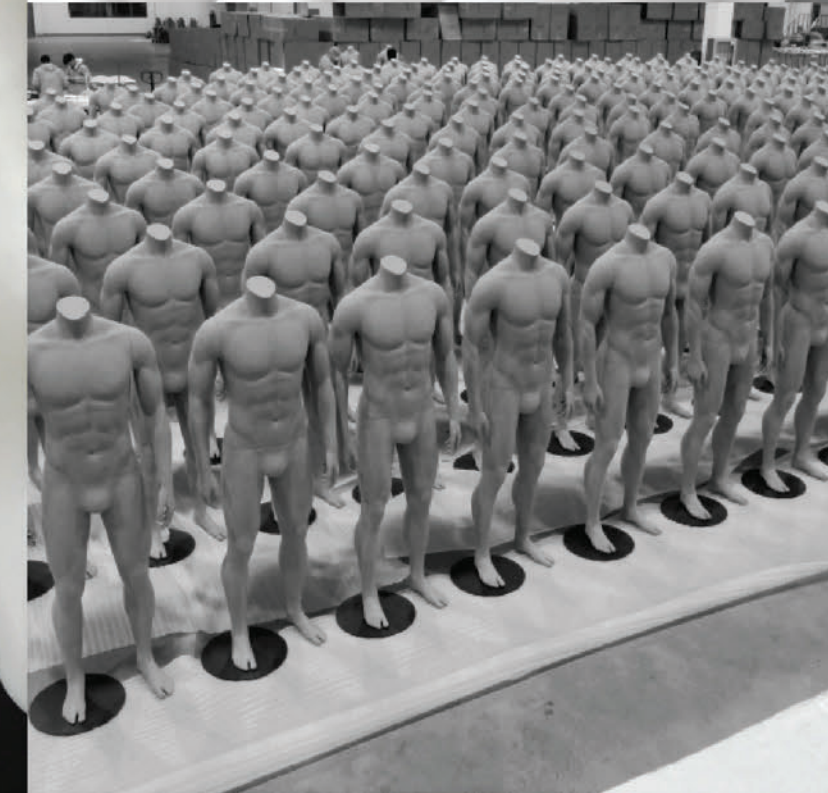
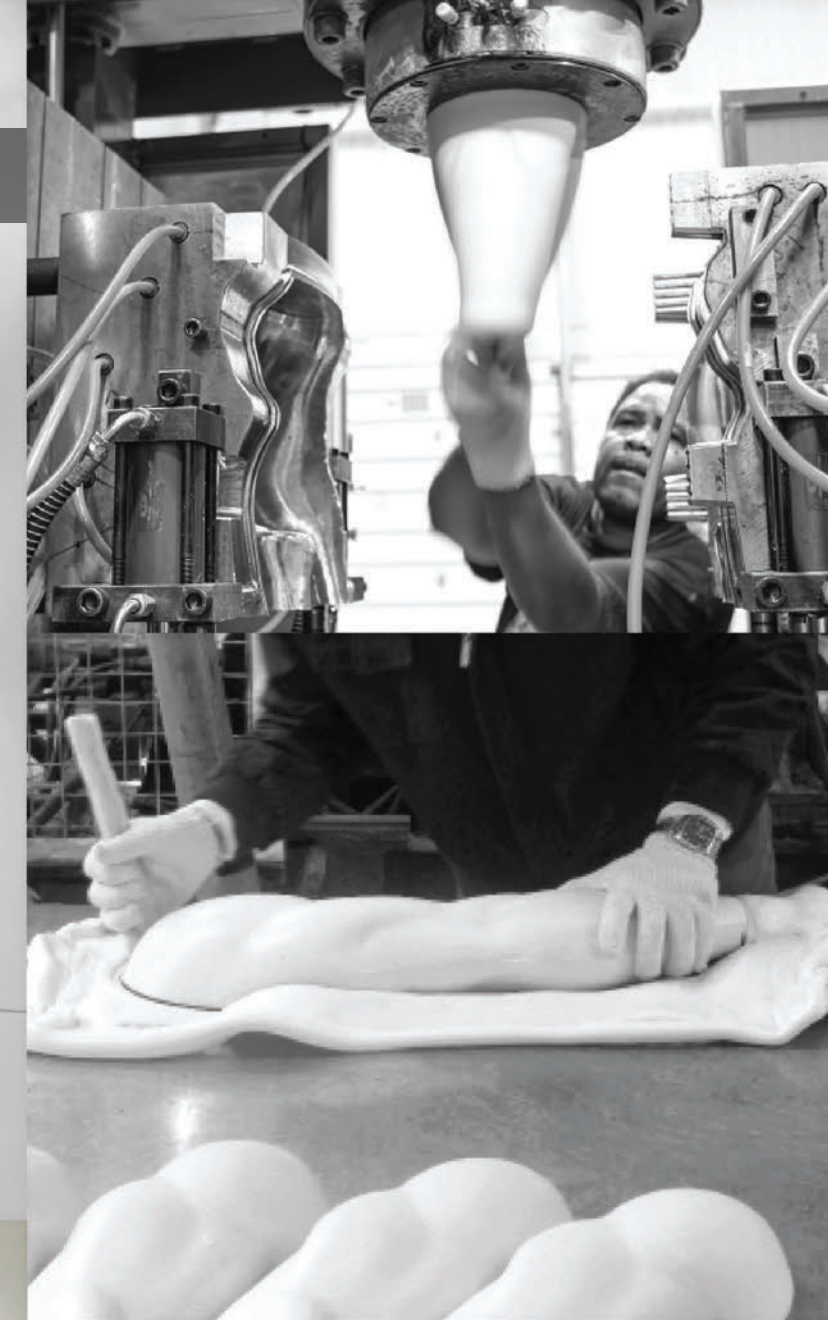

MADE WITH

PRP
PROPRIETARY
POLYPROPYLENE
FORMULA

VIRTUAL COLLABORATION

- Full 3D body scanning capabilities
- Digital cloning + Size matching
- Live on-screen 3D Sculpting, modeling, visuals
- Designed for 3D Printing + mold making
- Functional 1:1 life-size prototyping + fit tests

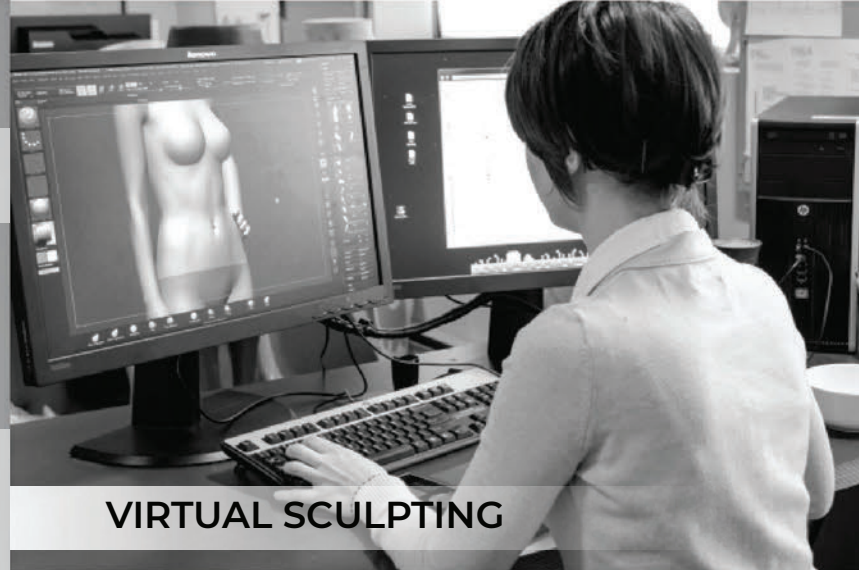

VIRTUAL SCULPTING

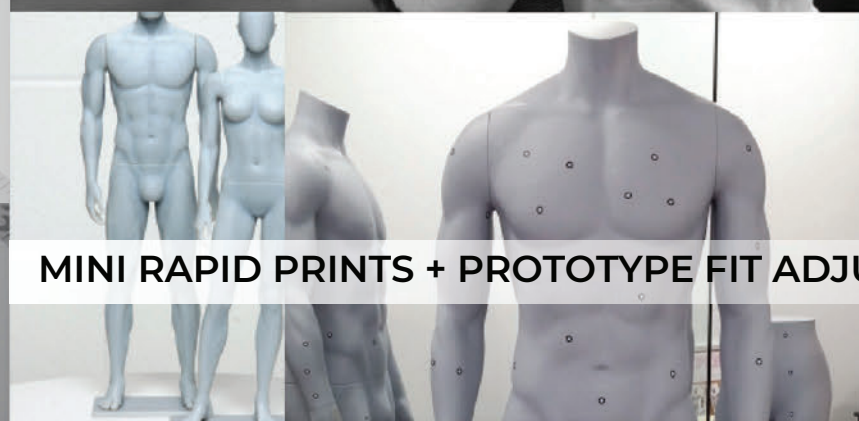

MINI RAPID PRINTS + PROTOTYPE FIT ADJUSTMENTS

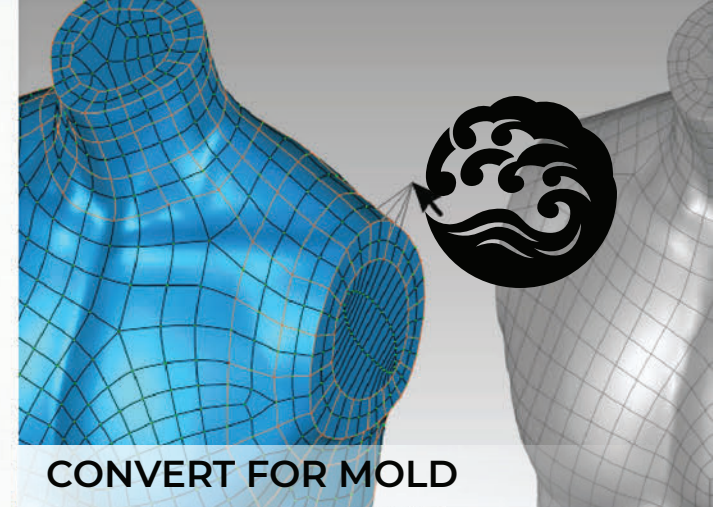

CONVERT FOR MOLD

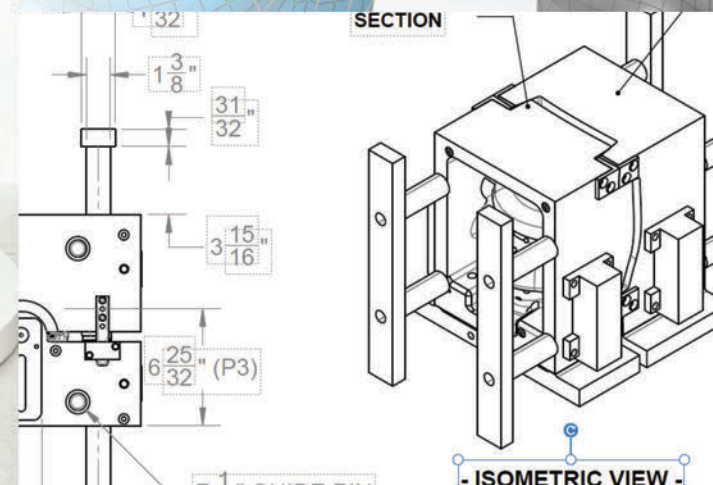

LIVE SCANNING



VIRTUAL POSE MATCHING FROM PHOTOS

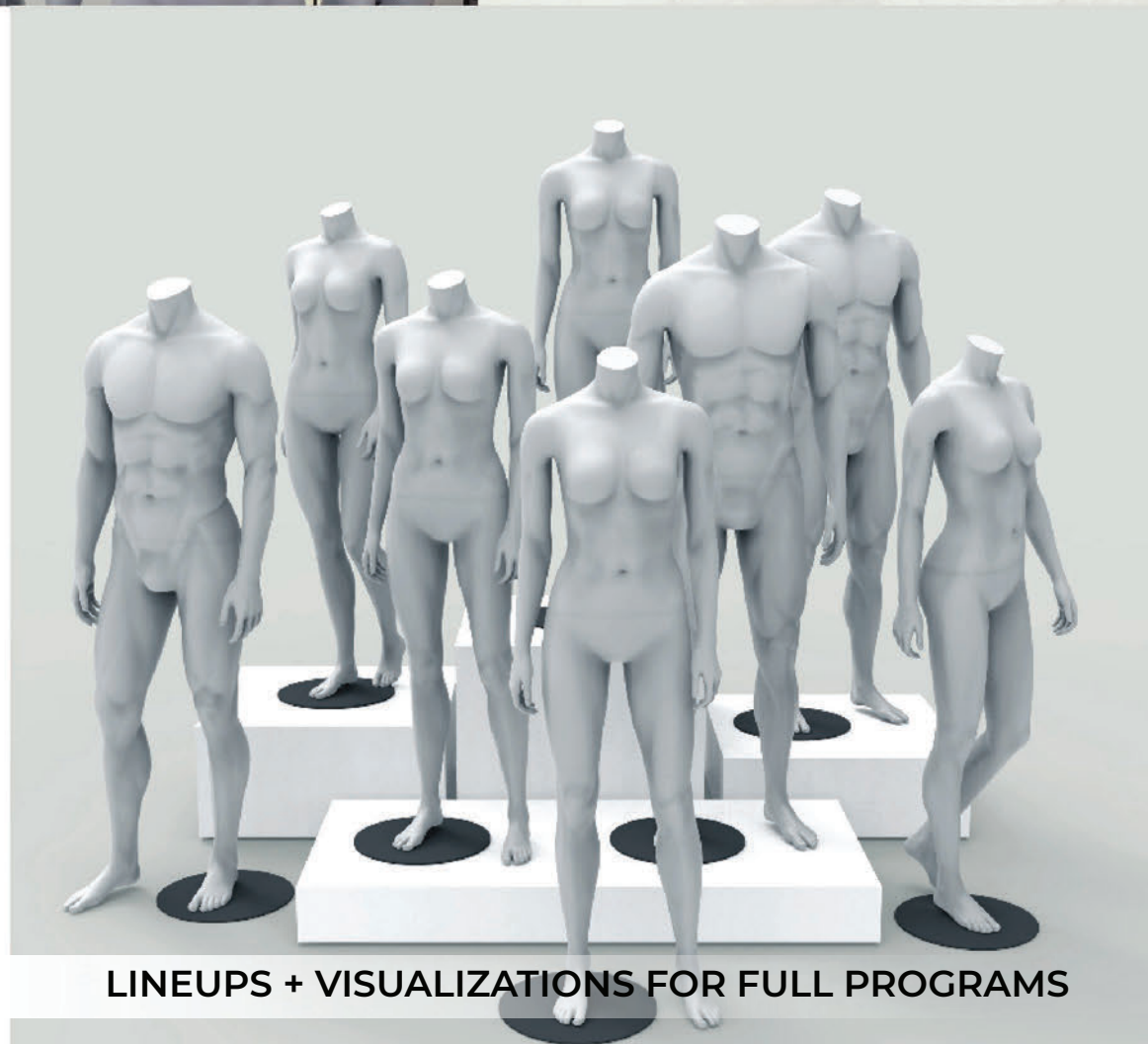
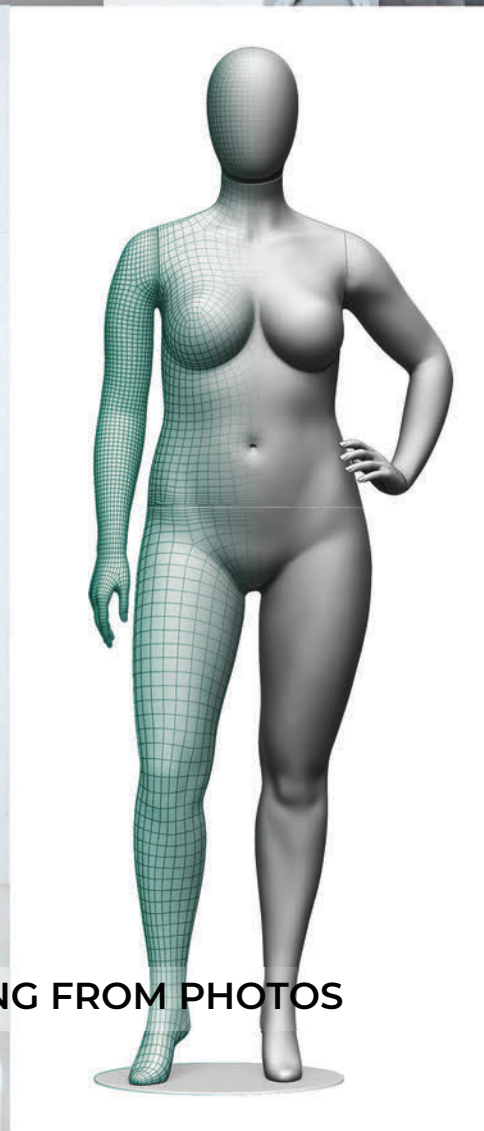

LINEUPS + VISUALIZATIONS FOR FULL PROGRAMS



3D PRINTING

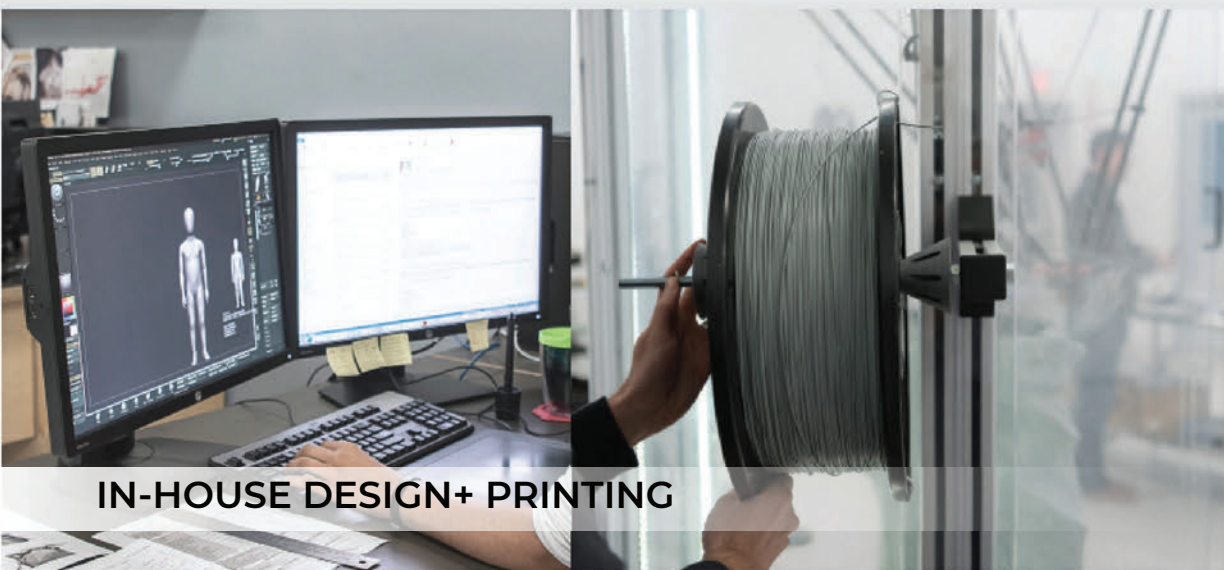

IN-HOUSE DESIGN+ PRINTING



1:6 RAPID PRINT MINIS



FDM PRINTING WITH ECO-T PLA

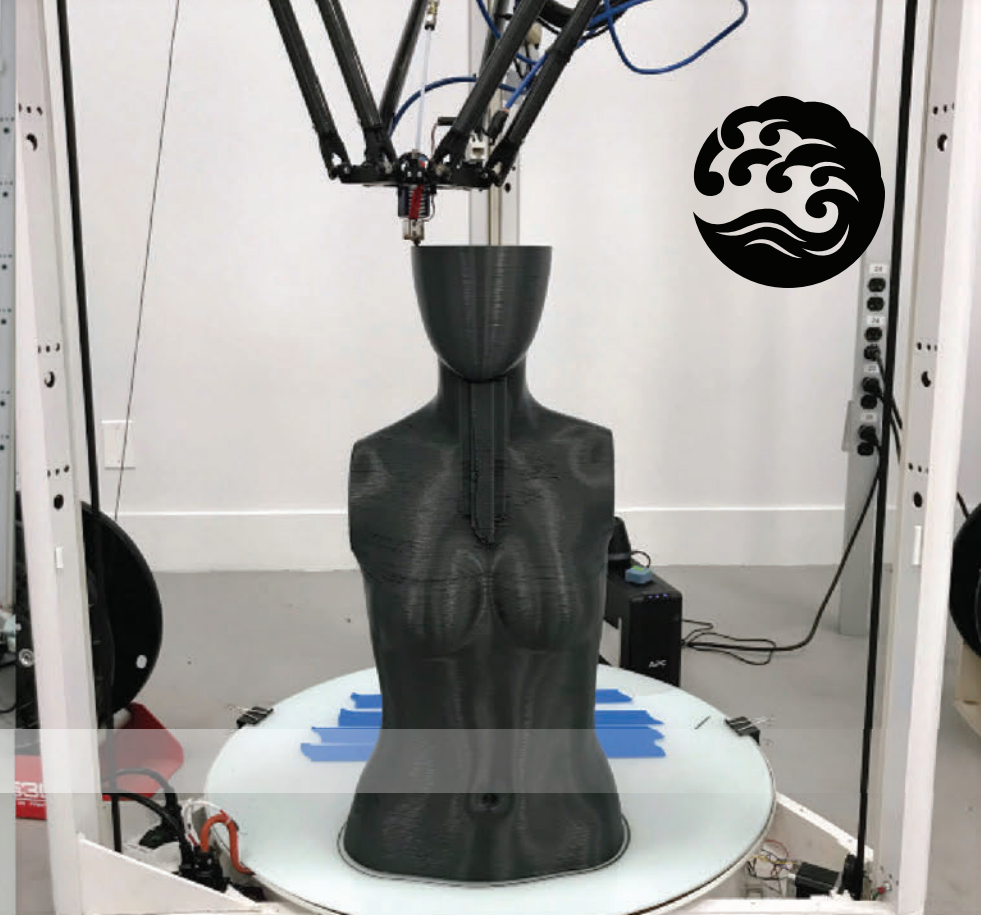

PRINTER FLEET

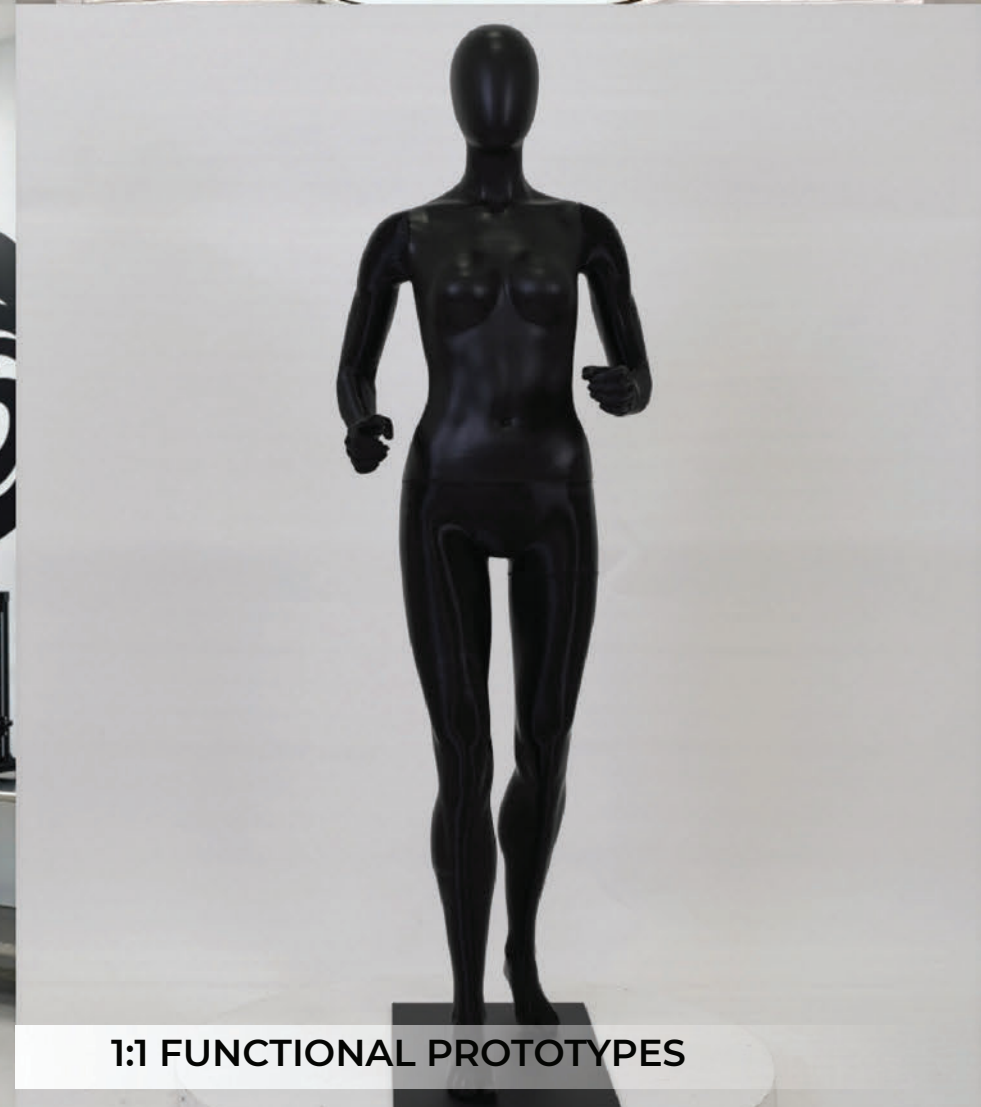

1:1 FUNCTIONAL PROTOTYPES

CREATIVE PROBLEM-SOLVING

DEBOSSSED BRANDING



GROCERY ENVIRONMENT



- Strong as a shopping cart
- Lightweight
- Affordable luxury
- Eco-friendly + Recyclable



KIT & ACE



JOE FRESH



SIZE INCLUSIVE: VICTORIA'S SECRET & CO



- seamless collaboration with VS&Co design team for their "Store of the Future"
- custom body diverse + size inclusive shapes
- fabricated from lightweight recycled material + color infused forms
- manufactured at our local full-service facilities in North America
- produced + distributed to fleet of 800+ stores

2021 FORM ROLLOUT:

- 50,000 BLOW MOLDED FORMS IN RECYCLED PRP MATERIAL
- 6-MONTH PRODUCTION TIME, ALL IN TORONTO



VS STORE OF THE FUTURE CHICAGO, IL



PINK - POLARIS FASHION PLACE



COLUMBUS, OH

BODY DIVERSITY: SAVAGE X FENTY

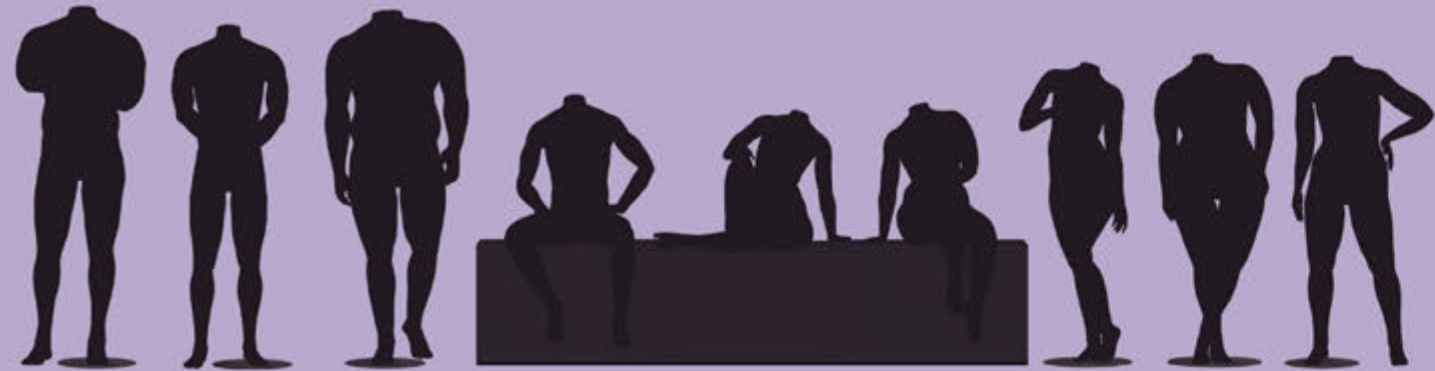

- campaign selected from 7 diverse body types
- virtually sculpted from brand-selected model measurements + photos
- rapid design iteration of 40+ poses
- 1:1 lifesize 3D prints casted for molds
- expertly sourced finishes to match existing store concept
- collaborative partnership to integrate seamlessly into final stores



REPRESENTATION: LANE BRYANT

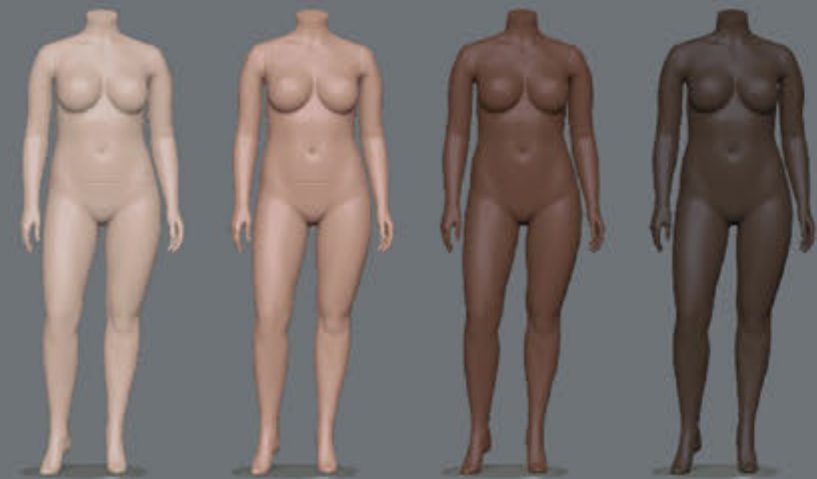

- designed to challenge size + diversity representation in retail spaces
- (4) four custom colors infused in our proprietary PRP blend
- both hard body mannequins + soft upholstered forms in inclusive plus sizes

FABRIC + UPHOLSTERY

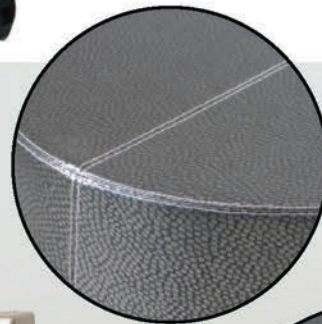
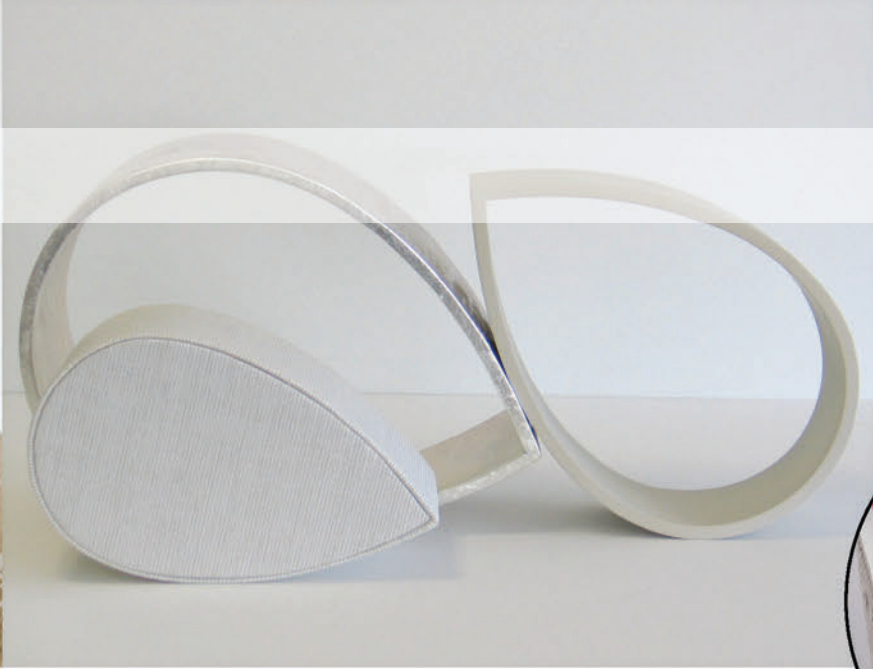
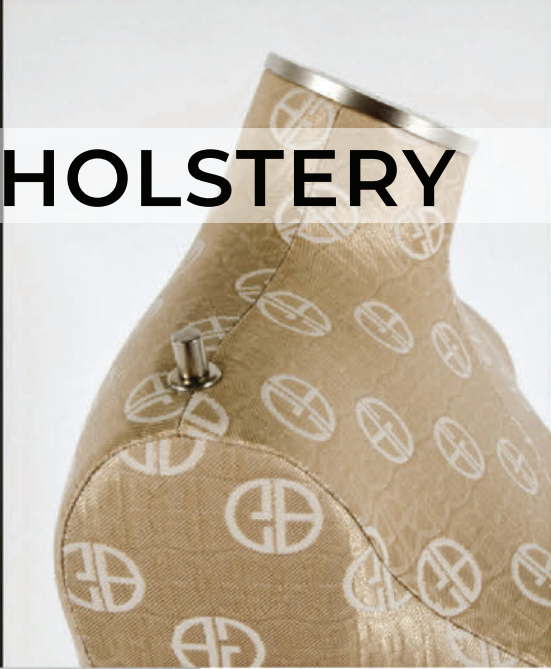

- Pattern Making
- Lamination
- Screen + Digital printing
- Stamping
- 2-Tones: mix + match
- Covers: Slips + Zips
- Top stitching
- Tea staining
- Quilting / Tufting
- Specialty Fabric
- Antimicrobial
- Sourcing



We've got you covered

FABRIC + UPHOLSTERY: THE SOFTEE SOLUTION



SOFT BnB



SOFT BnB



CHEEKY

THE SOFT SELL

- Realistic look + perfect fit
- No gaps, bridging or pinning
- Creates personality + inspires confidence
- Multiple bust / hip options per form



DECORATIVES + ACCESSORIES



DAVID YURMAN

MACY'S CHARTER CLUB



DFS VENICE

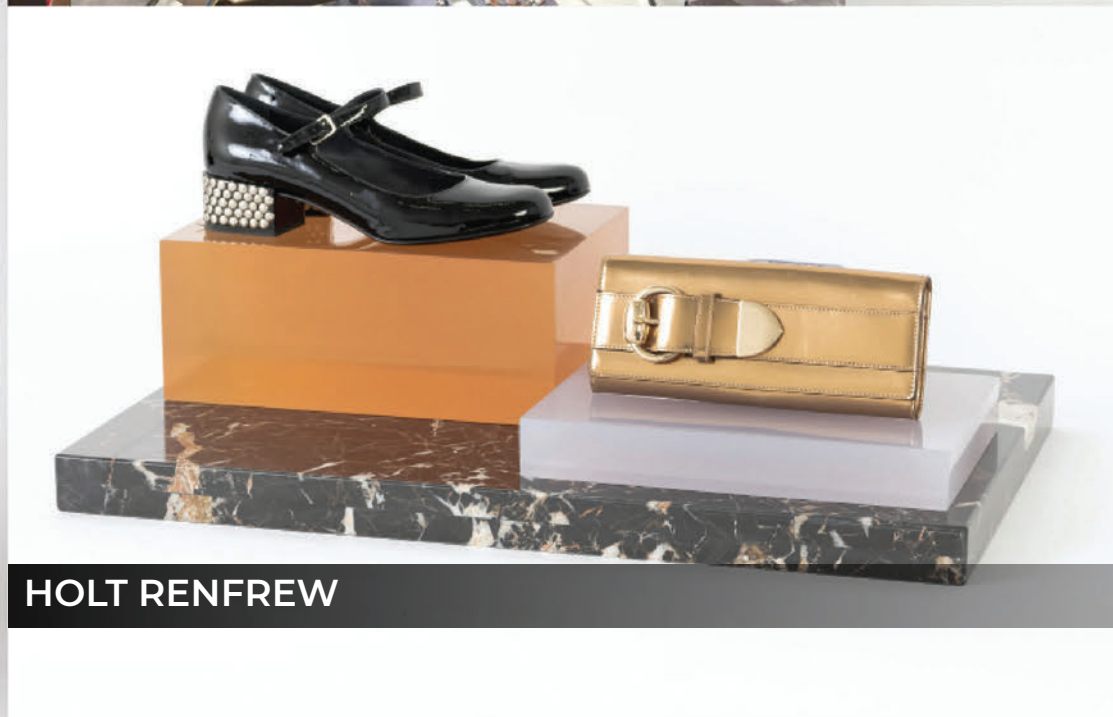

HOLT RENFREW



FIXTURE + FURNITURE PROGRAMS



NEIMAN MARCUS SAN FRANCISCO



- Seating
- Armoires
- Feature / nesting Tables
- Credenzas
- Impulse Fixtures
- Perimeter Walls
- Gondolas
- Vitrines
- Etagere
- Hang Racks
- Post Fixtures
- Hardware

DESIGN + BUILD + INSTALL: IDEATION TO DELIVERY

POP INS + POP UP SHOPS

- construction improvements
- exact build specifications
- multiple stakeholder collaboration
- regional sourcing on-site assembly



IN- STORE TESTS

- design iteration, sourcing + manufacturing
- 235 door rollout
- 12+ items
- sales increase of 32%

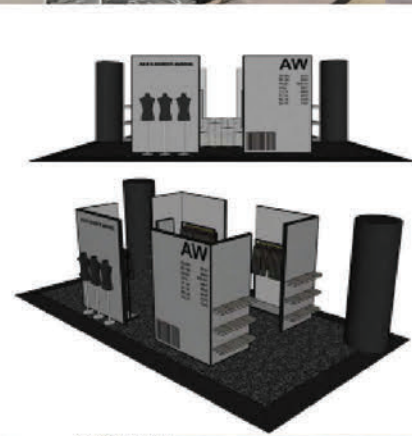

DESIGN + BUILD + INSTALL: MEC



MEC CALGARY, ALBERTA



- multi-store fixture rollout + installation
- mannequin program including standing adults, kids + active
- head + bust form displays

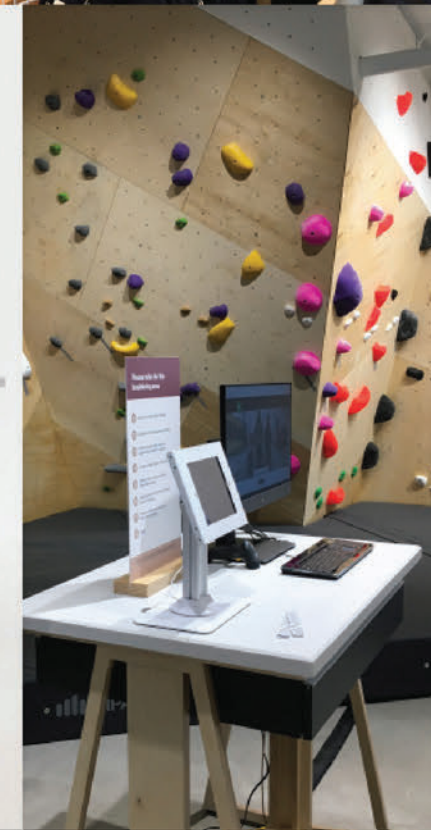

TORONTO FLAGSHIP TORONTO, ONTARIO

VANCOUVER FLAGSHIP VANCOUVER, BRITISH COLUMBIA

SPECIALIZED MATERIALS, SOURCING, FINISHING

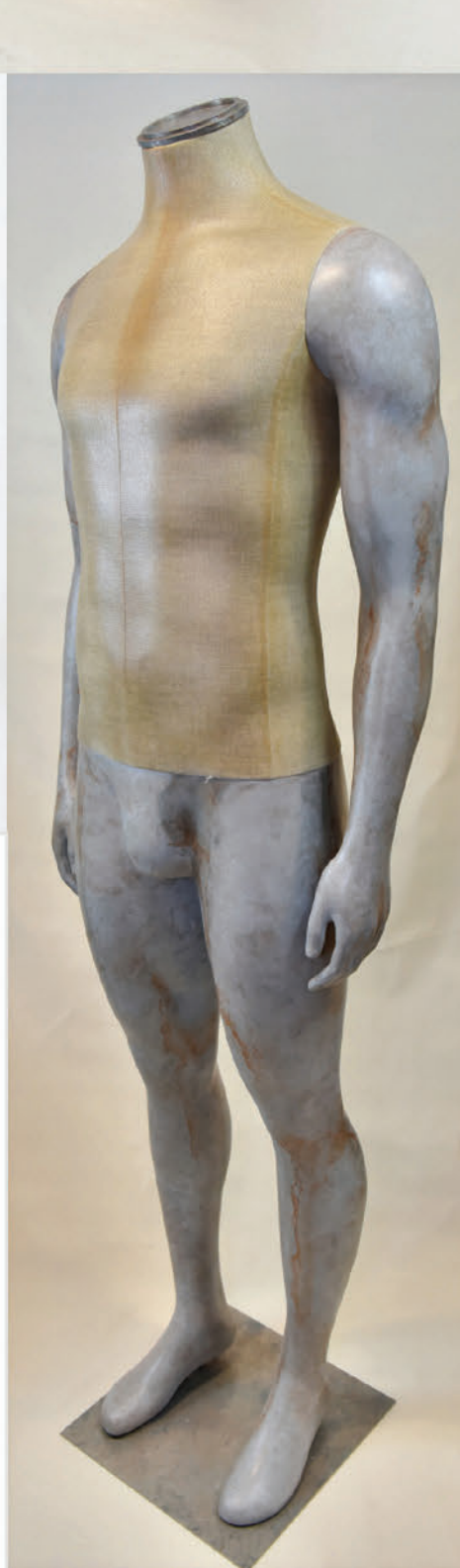

- Metallizing
- Faux Finishing
- Plating
- Stone
- Casting
- Resin
- Paper Mache
- Bamboo



BRANDING + SIGNAGE

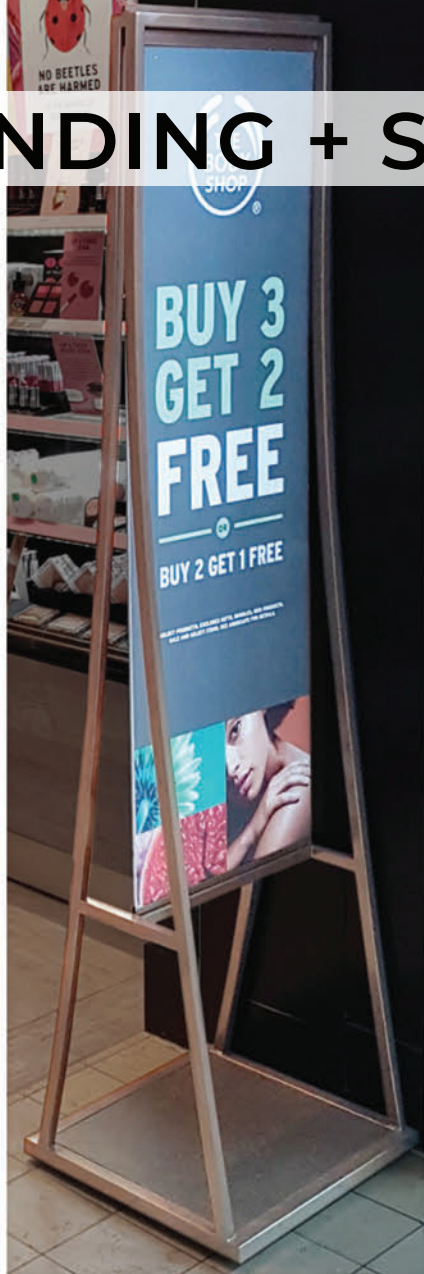

COLLABORATION: BRANDS THAT TRUST US



ANN TAYLOR



bloomingdales

HUDSON'S BAY



Buckle



DAILY THREAD

DAVID YURMAN

Dillard's
The Style of Your Life.



F FABLETICS



HOLT RENFREW

JOE FRESH

LANE BRYANT

LORNA JANE
ACTIVE LIVING

lululemon

macy's

maurices



MK
MICHAEL KORS



Neiman Marcus

NORDSTROM

patagonia



Saks Fifth Avenue

SAVAGE
FENTY
LINGERIE BY RIHANNA

SOMA

Vera Bradley



SEVEN^{CO}NTINENTS

Let's see what we can accomplish together.

GET IN TOUCH

 www.sevencontinents.com

 info@sevencontinents.com

 +1 416 784 3717 / 1 800 388 4826