

DPD Method¹

Method 8016

0.05 to 4.50 mg/L Br₂

Powder Pillows or AccuVac[®] Ampuls

Scope and application: For testing bromine residuals (including hypobromite, hypobromous acid and bromamines) in water and wastewater.

¹ Adapted from Standard Methods for the Examination of Water and Wastewater.



Test preparation

Before starting

Analyze the samples immediately. The samples cannot be preserved for later analysis.

Always do tests in sample cells or AccuVac[®] Ampuls. Do not put the instrument in the sample or pour the sample into the cell holder.

Make sure that the sample cells are clean and there are no scratches where the light passes through them.

Rinse the sample cell and cap with the sample three times before the sample cell is filled.

Make sure that there are no fingerprints or liquid on the external surface of the sample cells or AccuVac[®] Ampuls. Wipe with a lint-free cloth before measurement.

Cold waters can cause condensation on the sample cell or bubbles in the sample cell during color development. Examine the sample cell for condensation or bubbles. Remove condensation with a lint-free cloth. Invert the sample cell to remove bubbles.

Install the instrument cap over the cell holder before ZERO or READ is pushed.

If the test result is over-range, or if the sample temporarily turns yellow after the reagent addition, dilute the sample with a known volume of high quality, bromine demand-free water and do the test again. Some loss of bromine may occur due to the dilution. Multiply the result by the dilution factor. Additional methods are available to measure bromine without dilution.

After the test, immediately empty and rinse the sample cell. Rinse the sample cell and cap three times with deionized water.

For the best results, measure the reagent blank value for each new lot of reagent. Replace the sample with deionized water in the test procedure to determine the reagent blank value. Subtract the reagent blank value from the sample results.

The AccuVac Ampul Snapper makes AccuVac Ampul tests easier to do. The AccuVac Ampul Snapper keeps the broken tip of the ampul, prevents exposure to the sample and provides controlled conditions for filling the ampule.

An AccuVac Ampul for Blanks can be used to zero the instrument in the AccuVac test procedure.

The SwifTest Dispenser for Total Chlorine can be used in place of the powder pillow in the test procedure. One dispensation is equal to one powder pillow for 10-mL samples.

Review the Safety Data Sheets (MSDS/SDS) for the chemicals that are used. Use the recommended personal protective equipment.

Dispose of reacted solutions according to local, state and federal regulations. Refer to the Safety Data Sheets for disposal information for unused reagents. Refer to the environmental, health and safety staff for your facility and/or local regulatory agencies for further disposal information.

Items to collect

Powder pillows

Description	Quantity
DPD Total Chlorine Reagent Powder Pillow, 10-mL	1
Sample cells, 25-mm (10 mL)	2

Refer to [Consumables and replacement items](#) on page 6 for order information.

AccuVac Ampuls

Description	Quantity
DPD Total Chlorine Reagent AccuVac® Ampul	1
Beaker, 50-mL	1
Stopper for 18-mm tubes and AccuVac Ampuls	1
Sample cells, 25-mm (10 mL)	1

Refer to [Consumables and replacement items](#) on page 6 for order information.

Sample collection

- Analyze samples for bromine immediately after collection.
- Bromine is a strong oxidizing agent and is unstable in natural waters. Bromine reacts quickly with various inorganic compounds and more slowly with organic compounds. Many factors, including reactant concentrations, sunlight, pH, temperature and salinity influence the decomposition of bromine in water.
- Collect samples in clean glass bottles. Do not use plastic containers because these can have a large bromine demand.
- Pretreat glass sample containers to remove bromine demand. Soak the containers in a weak bleach solution (1 mL commercial bleach to 1 liter of deionized water) for at least 1 hour. Rinse fully with deionized or distilled water. If sample containers are rinsed fully with deionized or distilled water after use, only occasional pretreatment is necessary.
- Make sure to get a representative sample. If the sample is taken from a spigot or faucet, let the water flow for at least 5 minutes. Let the container overflow with the sample several times and then put the cap on the sample container so that there is no headspace (air) above the sample.

Powder pillow procedure

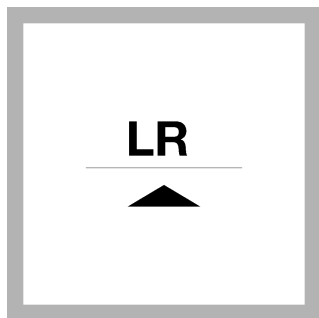

1. Set the instrument to low range (LR).

For DR300, push the up arrow button. For PCII, push the menu button, checkmark button, then the menu button again.

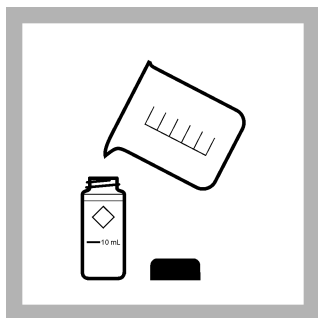

2. Prepare the sample:

Rinse a sample cell and cap three times with sample. Fill the sample cell to the 10-mL mark with sample.

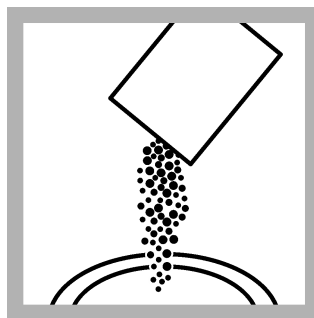

3. Add one DPD Total Chlorine Reagent Powder Pillow to the sample cell.

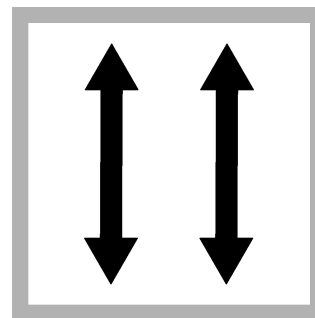

4. Put the stopper on the sample cell. Shake the sample cell for about **20 seconds** to dissolve the reagent. Undissolved powder will not affect accuracy.. A pink color will show if bromine is in the sample.



5. Set and start a timer for 3 minutes. A 3-minute reaction time starts.

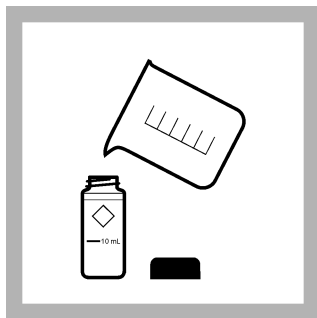

6. Prepare the blank: Rinse a sample cell and cap three times with sample. Fill the sample cell to the 10-mL mark with sample. Close the sample cell.

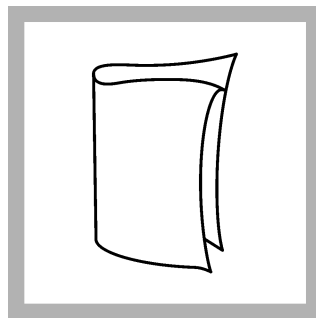

7. Clean the blank sample cell.

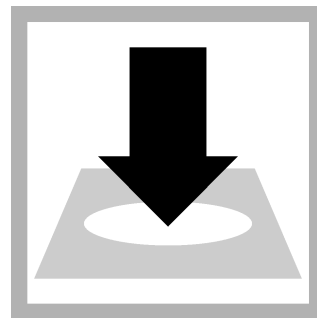

8. Insert the blank into the cell holder. Point the diamond mark on the sample cell toward the keypad.

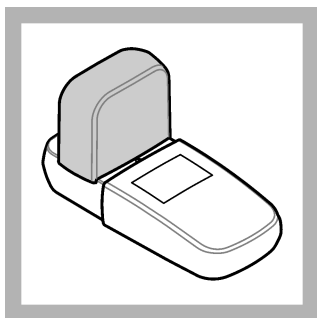

9. Install the instrument cap over the cell holder.

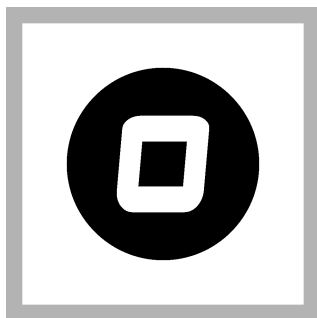

10. Push **ZERO**. The display shows "0.00".

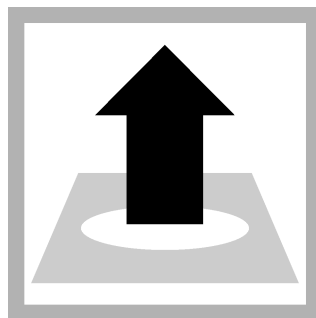

11. Remove the sample cell from the cell holder.

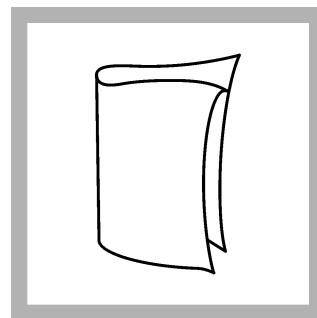

12. Clean the prepared sample cell.

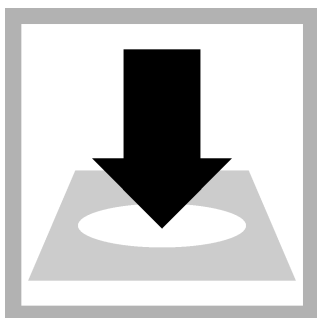

13. Within 3 minutes after the timer expires, insert the prepared sample into the cell holder. Point the diamond mark on the sample cell toward the keypad.

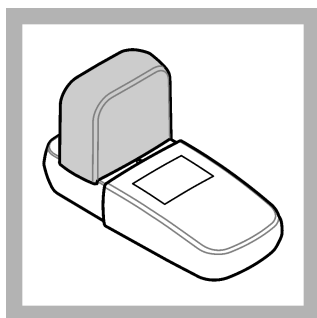

14. Install the instrument cap over the cell holder.

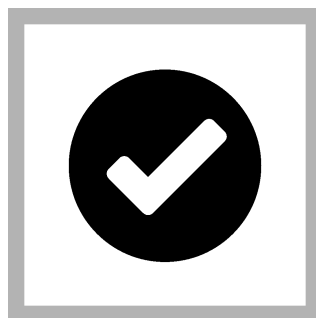

15. Push **READ**. Results show in mg/L bromine (BR₂).

AccuVac® Ampul procedure

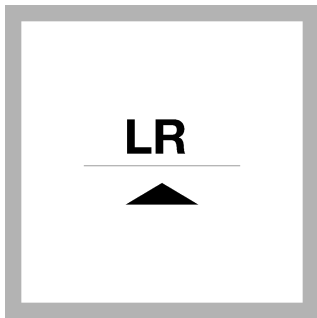

1. Set the instrument to low range (LR).

For DR300, push the up arrow button. For PCII, push the menu button, checkmark button, then the menu button again.

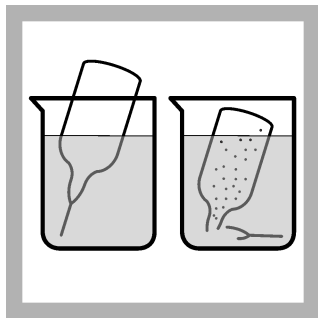

2. Prepare the sample:

Collect at least 40 mL of sample in a 50-mL beaker. Fill the AccuVac Ampul with sample. Keep the tip immersed while the AccuVac Ampul fills completely.

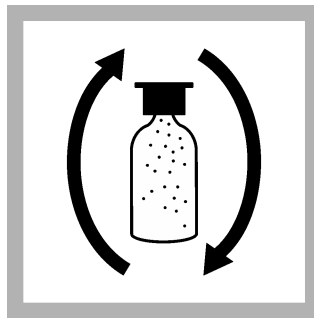

3. Quickly invert the AccuVac Ampul several times to mix.

Undissolved power will not affect accuracy. A pink color will show if bromine is in the sample.

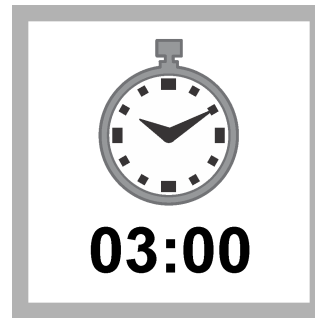

4. Set and start a timer for 3 minutes. A 3-minute reaction time starts.

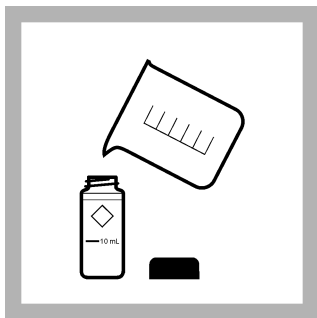

5. Prepare the blank:

Rinse a sample cell and cap three times with sample. Fill the sample cell to the 10-mL mark with sample. Close the sample cell.

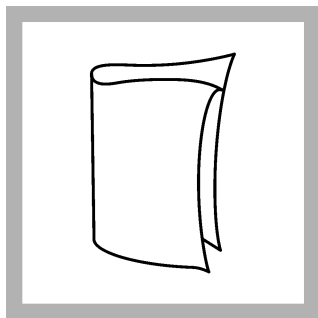

6. Clean the blank sample cell.

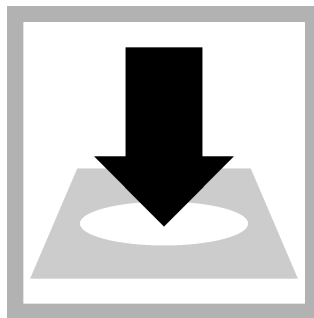

7. Insert the blank into the cell holder. Point the diamond mark on the sample cell toward the keypad.

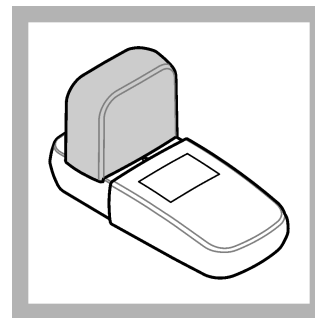

8. Install the instrument cap over the cell holder.

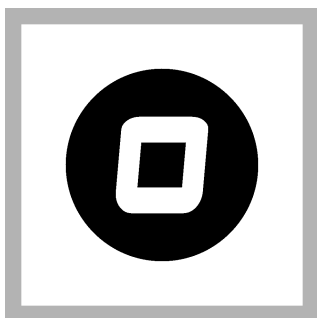

9. Push **ZERO**. The display shows "0.00".

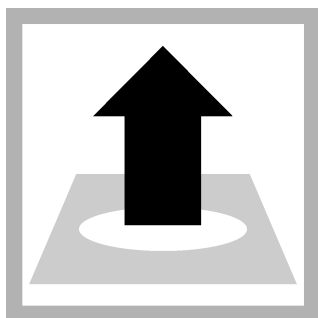

10. Remove the sample cell from the cell holder.

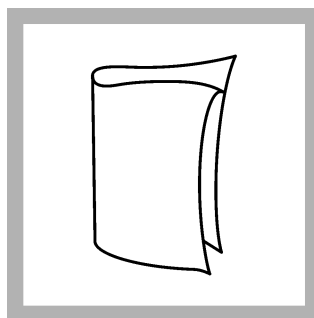

11. Clean the AccuVac Ampul.

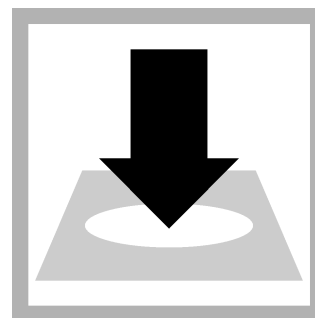

12. Within 3 minutes after the timer expires, insert the prepared sample AccuVac Ampul into the cell holder.

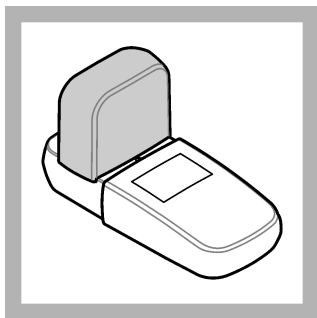

13. Install the instrument cap over the cell holder.

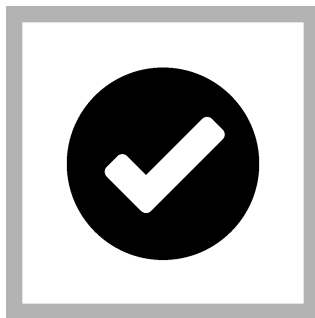

14. Push **READ**. Results show in mg/L bromine (BR₂).

Interferences

Interfering substance	Interference level
Acidity	More than 150 mg/L CaCO ₃ . The full color may not develop or the color may fade instantly. Neutralize to pH 6–7 with 1 N Sodium Hydroxide. Measure the amount to be added on a separate sample aliquot, then add the same amount to the sample that is tested. Correct the test result for the dilution caused by the volume addition.
Alkalinity	More than 250 mg/L CaCO ₃ . The full color may not develop or the color may fade immediately. Neutralize to pH 6–7 with 1 N Sulfuric Acid. Measure the amount to add on a separate sample aliquot, then add the same amount to the sample that is tested. Correct the test result for the dilution caused by the volume addition.
Chlorine	Causes positive interference
Chlorine Dioxide	Causes positive interference
Chloramines, organic	May cause positive interference
Hardness	No effect at less than 1000 mg/L as CaCO ₃
Iodine	Causes positive interference
Manganese, Oxidized (Mn ⁴⁺ , Mn ⁷⁺) or Chromium, Oxidized (Cr ⁶⁺)	Pre-treat the sample as follows: <ol style="list-style-type: none"> 1. Adjust the sample pH to 6–7. 2. Add 3 drops of Potassium Iodide (30-g/L) to 25 mL of sample. 3. Mix and wait 1 minute. 4. Add 3 drops of Sodium Arsenite¹ (5-g/L) and mix. 5. Use the test procedure to measure the concentration of 10 mL of the treated sample. 6. Subtract this result from the result without the treatment to obtain the correct bromine concentration.
Monochloramine	Causes positive interference
Ozone	Causes positive interference
Peroxides	May cause positive interference
Highly buffered samples or extreme sample pH	Can prevent the correct pH adjustment (of the sample) by the reagents. Sample pretreatment may be necessary. Adjust to pH 6–7 with acid (Sulfuric Acid, 1 N) or base (Sodium Hydroxide, 1 N). Correct the test result for the dilution caused by the volume additions.

Pollution prevention and waste management

If sodium arsenite was added to the sample for manganese or chromium interferences, the reacted samples will contain arsenic and must be disposed of as a hazardous waste. Dispose of reacted solutions according to local, state and federal regulations.

¹ Samples that are treated with sodium arsenite will contain arsenic and may require special disposal consideration. Refer to the current MSDS/SDS for safe handling and disposal instructions.

Accuracy check

Standard additions method

Use the standard additions method to validate the test procedure, reagents and instrument and to find if there is an interference in the sample.

Items to collect:

- Chlorine Standard Solution, 2-mL PourRite[®] Ampule, 25–30 mg/L (use mg/L on label)
- Ampule breaker
- Pipet, TenSette[®], 0.1–1.0 mL and tips

1. Prepare three spiked samples: use the TenSette pipet to add 0.1 mL, 0.2 mL and 0.3 mL of the standard solution, respectively, to three 10-mL portions of fresh sample. Mix well.

Note: For AccuVac[®] Ampuls, add 0.3 mL, 0.6 mL and 0.9 mL of the standard solution to three 30-mL portions of fresh sample.

2. Use the test procedure to measure the concentration of each of the spiked samples. Start with the smallest sample spike. Measure each of the spiked samples in the instrument.
3. Compare the expected result to the actual result. The expected increase in the chlorine concentration is the Cl₂ mg/L concentration from label multiplied by 0.1 mL for every 10 mL of standard solution added. Multiply the expected chlorine concentration by 2.25 to determine the expected increase in the bromine concentration.

Standard solution method

If the Standard Calibration Adjust feature is used to adjust the calibration curve of the DR300 or Pocket Colorimeter II, the concentration of the bromine standard must be between 2.00 and 4.00 mg/L bromine for the LR procedure. If a chlorine standard is used, multiply its concentration by 2.25 to determine the equivalent bromine concentration.

Method performance

The method performance data that follows was derived from laboratory tests that were measured on a DR300 and a Pocket Colorimeter II during ideal test conditions. Users can get different results under different test conditions.

Precision (95% confidence interval)
2.25 ± 0.11 mg/L Br ₂

Summary of method

Bromine residuals reacts with DPD (N,N-diethyl-p-phenylenediamine) to form a pink color, which is proportional to the total bromine concentration. To increase the range of analysis, more indicator is added in proportion to the sample volume in the high range procedure.

Consumables and replacement items

Required reagents

Description	Quantity/Test	Unit	Item no.
DPD Total Chlorine Reagent Powder Pillow, 10 mL	1	100/pkg	2105669
OR			
DPD Total Chlorine Reagent AccuVac [®] Ampul	1	25/pkg	2503025

Required apparatus (powder pillows)

Description	Quantity/test	Unit	Item no.
Sample cells, 10-mL round, 25 mm x 60 mm	2	6/pkg	2427606

Required apparatus (AccuVac Ampul)

Description	Quantity/Test	Unit	Item no.
Sample cell, 10-mL round, 25 mm x 60 mm	1	6/pkg	2427606
Beaker, 50 mL	1	each	50041H
Stoppers for 18-mm tubes and AccuVac Ampuls	2	6/pkg	173106

Optional reagents and apparatus

Description	Unit	Item no.
AccuVac [®] Ampul Snapper	each	2405200
AccuVac [®] Ampul vials for sample blanks	25/pkg	2677925
Ampule Breaker, 2-mL PourRite [®] Ampules	each	2484600
Mixing cylinder, graduated, 25-mL	each	2088640
Mixing cylinder, graduated, 50 mL	each	189641
Chlorine Standard Solution, 2-mL PourRite [®] Ampules, 25–30 mg/L	20/pkg	2630020
DPD Total Chlorine Reagent Powder Pillows, 10 mL	1000/pkg	2105628
DPD Total Chlorine Reagent Powder Pillows, 10 mL	300/pkg	2105603
SwifTest [™] dispenser for total chlorine ²	each	2802400
DPD Total Chlorine Reagent, 10-mL, SwifTest [™] Dispenser refill vial	250 tests	2105660
Paper, pH, 0–14 pH range	100/pkg	2601300
Pipet, TenSette [®] , 0.1–1.0 mL	each	1970001
Pipet tips for TenSette [®] Pipet, 0.1–1.0 mL	50/pkg	2185696
Pipet tips for TenSette [®] Pipet, 0.1–1.0 mL	1000/pkg	2185628
Potassium Iodide, 30-g/L	100 mL	34332
Sodium Arsenite, 5-g/L	100 mL	104732
Sodium Hydroxide Standard Solution, 1.0 N	100 mL MDB	104532
Sulfuric Acid Standard Solution, 1 N	100 mL MDB	127032
Water, Chlorine-demand Free	500 mL	2641549
Water, deionized	4 L	27256

² Includes one vial of 2105660 for 250 tests.



FOR TECHNICAL ASSISTANCE, PRICE INFORMATION AND ORDERING:
In the U.S.A. – Call toll-free 800-227-4224
Outside the U.S.A. – Contact the HACH office or distributor serving you.
On the Worldwide Web – www.hach.com; E-mail – techhelp@hach.com

HACH COMPANY
WORLD HEADQUARTERS
Telephone: (970) 669-3050
FAX: (970) 669-2932